



US00D638952S

(12) **United States Design Patent**
Oonuma et al.

(10) **Patent No.:** **US D638,952 S**

(45) **Date of Patent:** **** May 31, 2011**

(54) **MOLECULAR TESTING MACHINE**

(75) Inventors: **Mitsuru Oonuma**, Tokyo (JP); **Akira Omachi**, Komae (JP); **Masato Ishizawa**, Hitachinaka (JP); **Yoshiyuki Shoji**, Mito (JP)

(73) Assignee: **Hitachi High-Technologies Corporation**, Tokyo (JP)

(**) Term: **14 Years**

(21) Appl. No.: **29/365,821**

(22) Filed: **Jul. 15, 2010**

(30) **Foreign Application Priority Data**

Jan. 18, 2010 (JP) 2010-001001

(51) **LOC (9) Cl.** **24-01**

(52) **U.S. Cl.** **D24/216**

(58) **Field of Classification Search** D24/216-232, D24/186; D10/81; 422/500, 547, 62, 63; 435/287.1, 288.4; 436/43, 47, 46

See application file for complete search history.

(56) **References Cited**

U.S. PATENT DOCUMENTS

5,169,600	A *	12/1992	Ishizaka et al.	422/63
5,443,790	A *	8/1995	Coeurveille et al.	422/63
6,042,786	A *	3/2000	Oonuma et al.	422/63
D474,416	S *	5/2003	Oonuma et al.	D10/81
D491,272	S *	6/2004	Alden et al.	D24/216

6,841,126	B2 *	1/2005	Oonuma et al.	422/64
D508,999	S *	8/2005	Fanning et al.	D24/216
D523,153	S *	6/2006	Akashi et al.	D10/81
D588,276	S *	3/2009	Isozaki et al.	D24/232
D612,276	S *	3/2010	Duffy et al.	D10/81
D631,976	S *	2/2011	Oonuma et al.	D24/216
2008/0019868	A1 *	1/2008	Okumoto et al.	422/63
2009/0269841	A1 *	10/2009	Wojciechowski et al.	435/325

* cited by examiner

Primary Examiner — T. Chase Nelson

Assistant Examiner — Anhdao Doan

(74) *Attorney, Agent, or Firm* — Antonelli, Terry, Stout & Kraus, LLP.

(57) **CLAIM**

We claim the ornamental design for a molecular testing machine, as shown and described.

DESCRIPTION

FIG. 1 is a front, top and right side perspective view of a molecular testing machine showing our new design; FIG. 2 is a front elevational view thereof; FIG. 3 is a rear elevational view thereof; FIG. 4 is a top plan view thereof; FIG. 5 is a bottom plan view thereof; FIG. 6 is a left side elevational view thereof; and, FIG. 7 is a right side elevational view thereof.

The broken lines in FIG. 3 are included for the purpose of illustrating a portion of the molecular testing machine that forms no part of the claimed design.

1 Claim, 6 Drawing Sheets

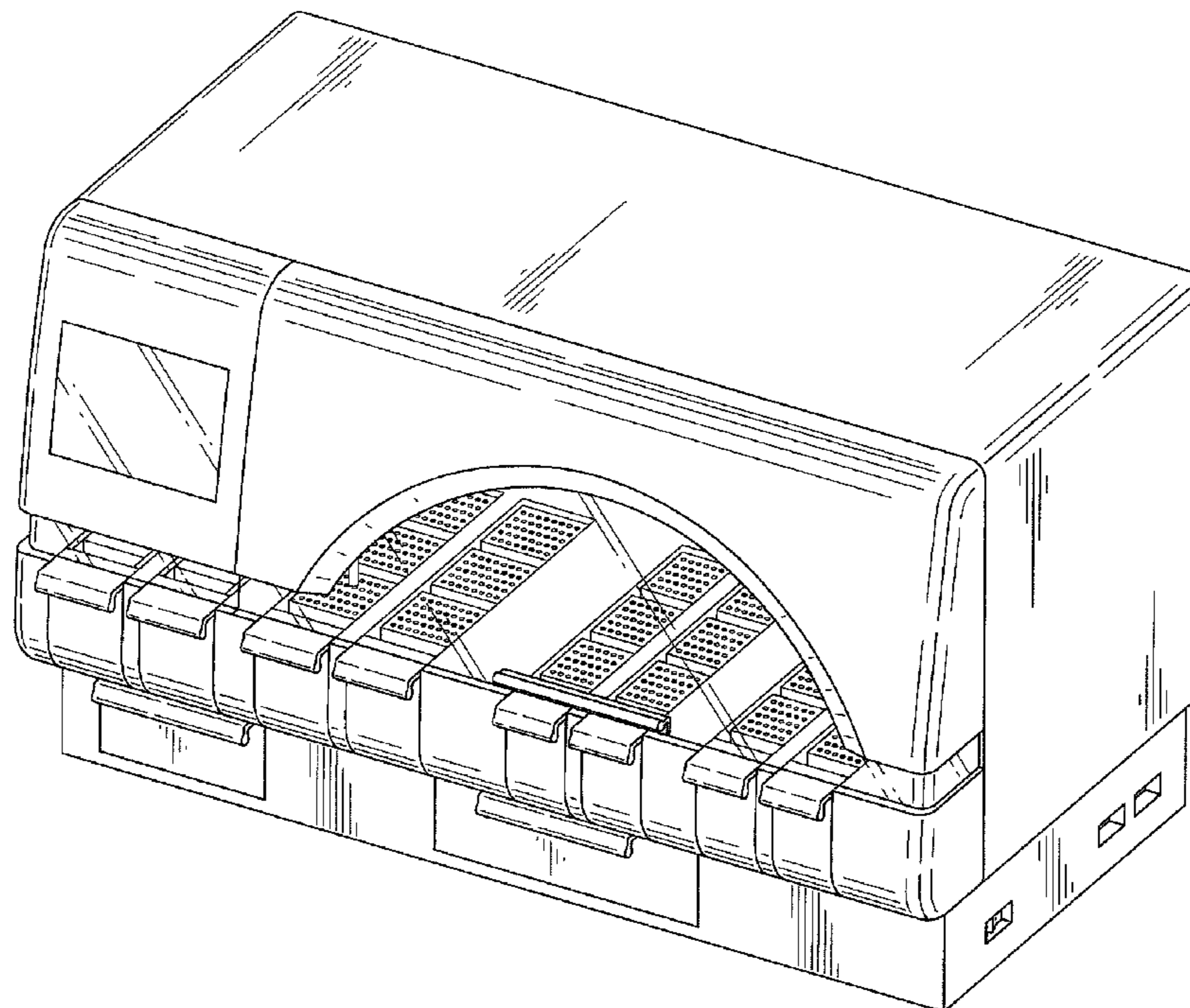

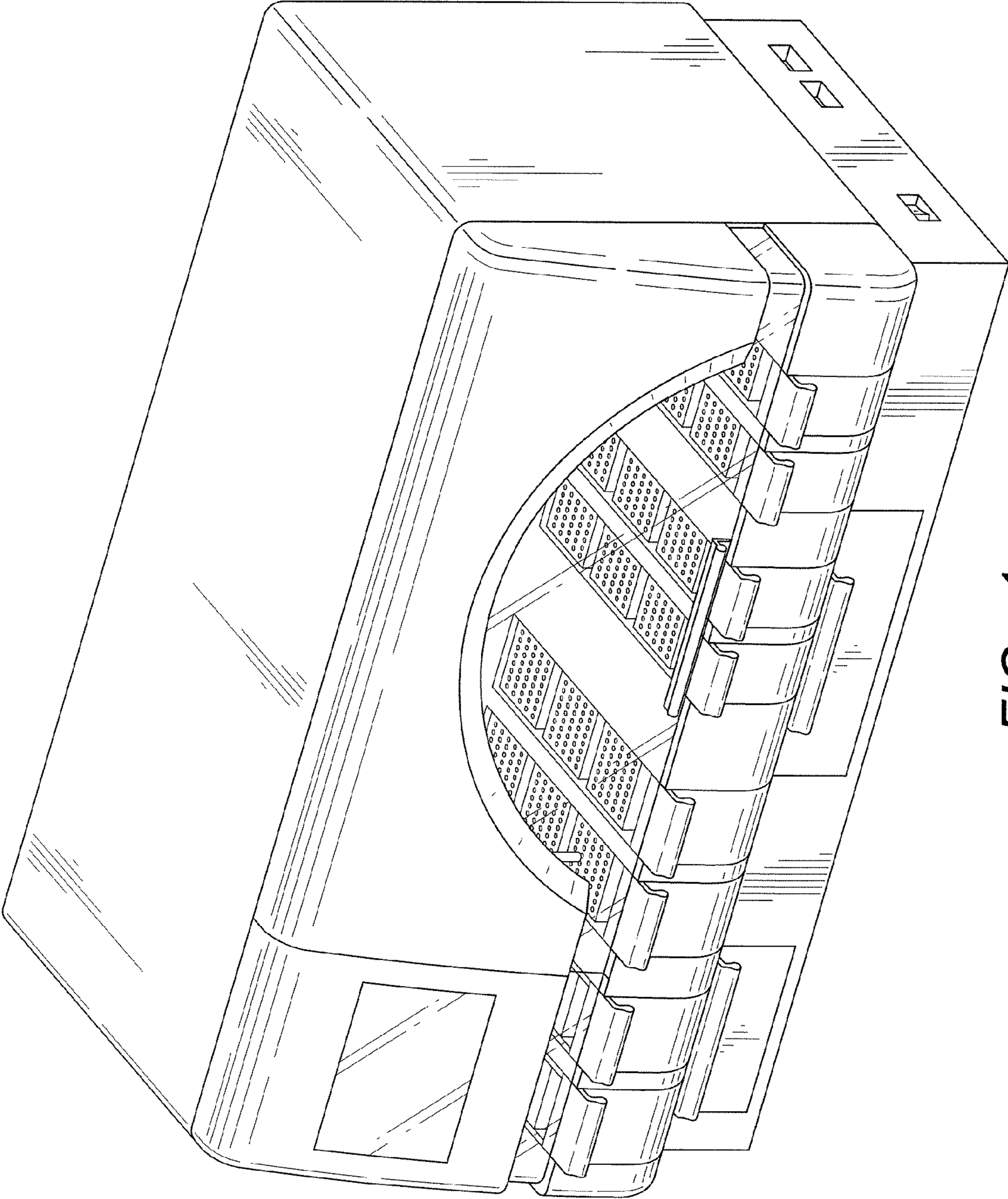

FIG. 1

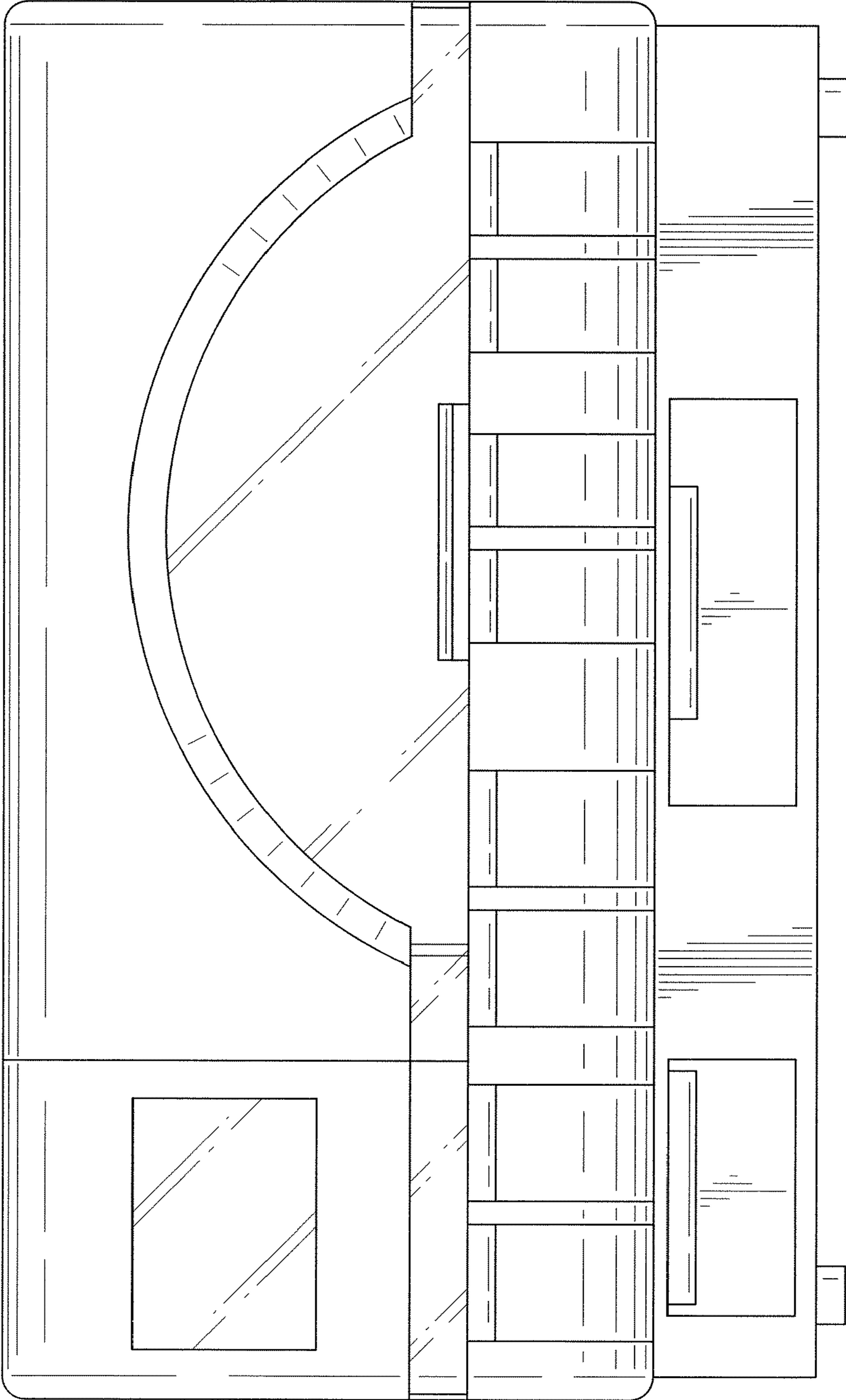

FIG. 2

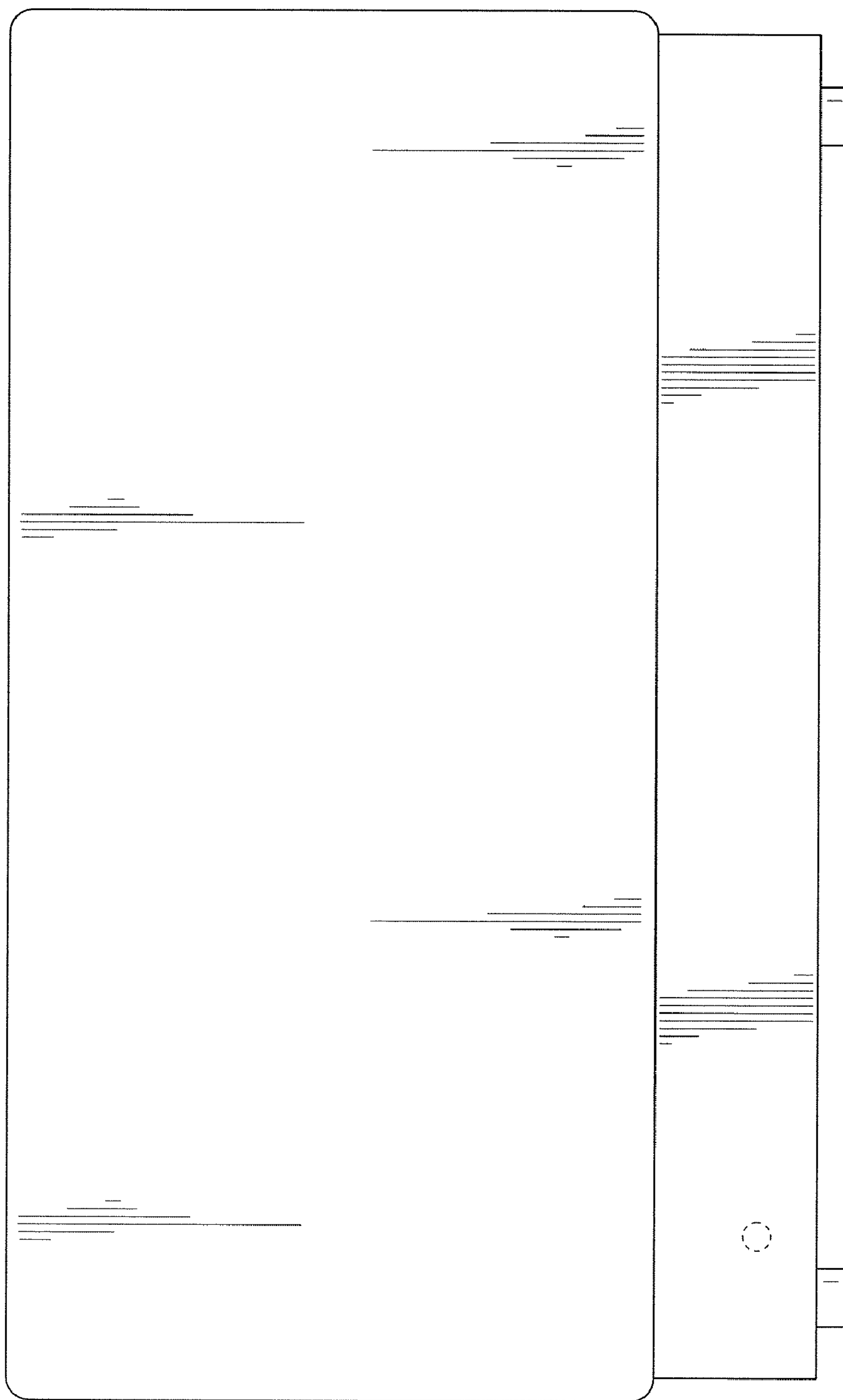

FIG. 3

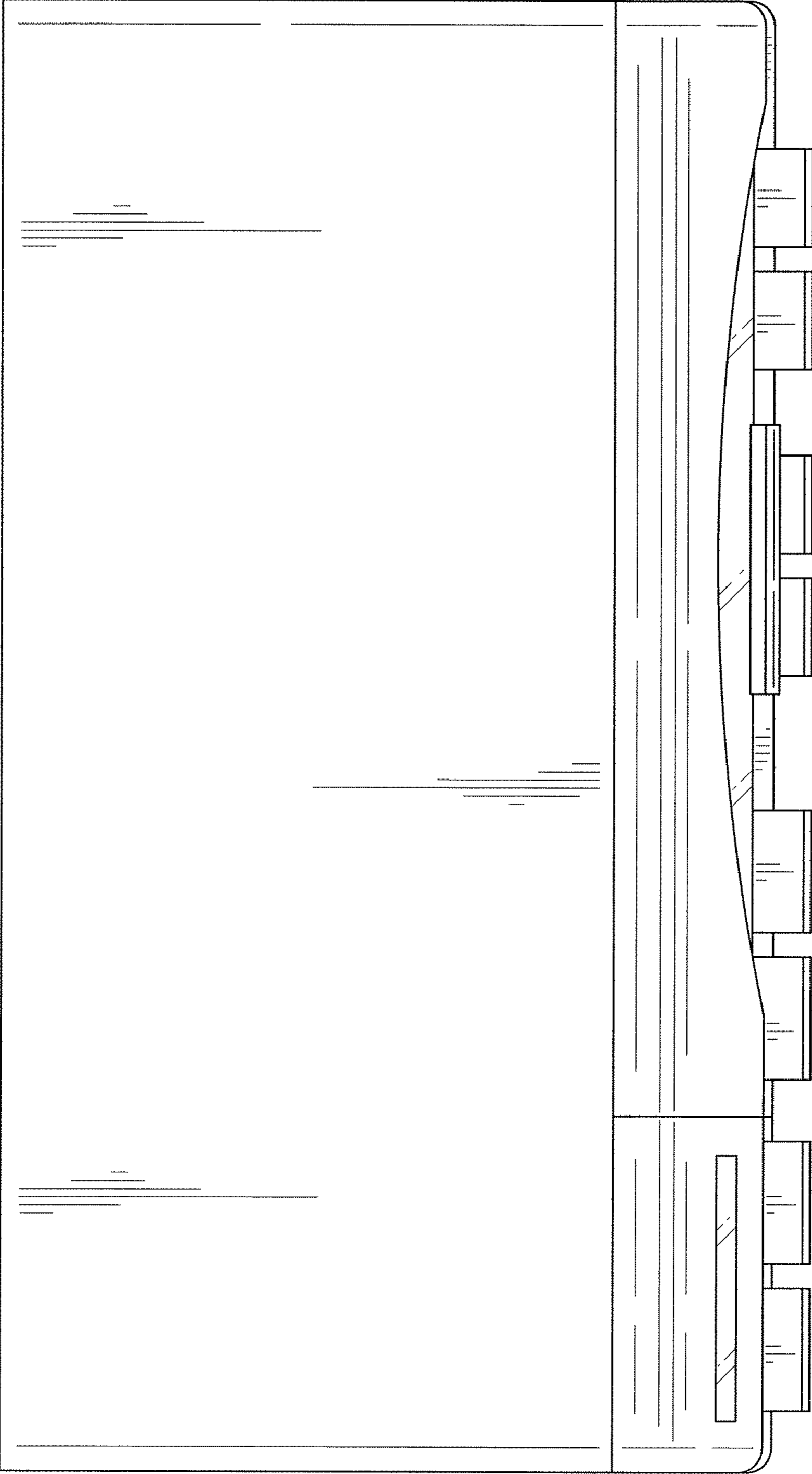

FIG. 4

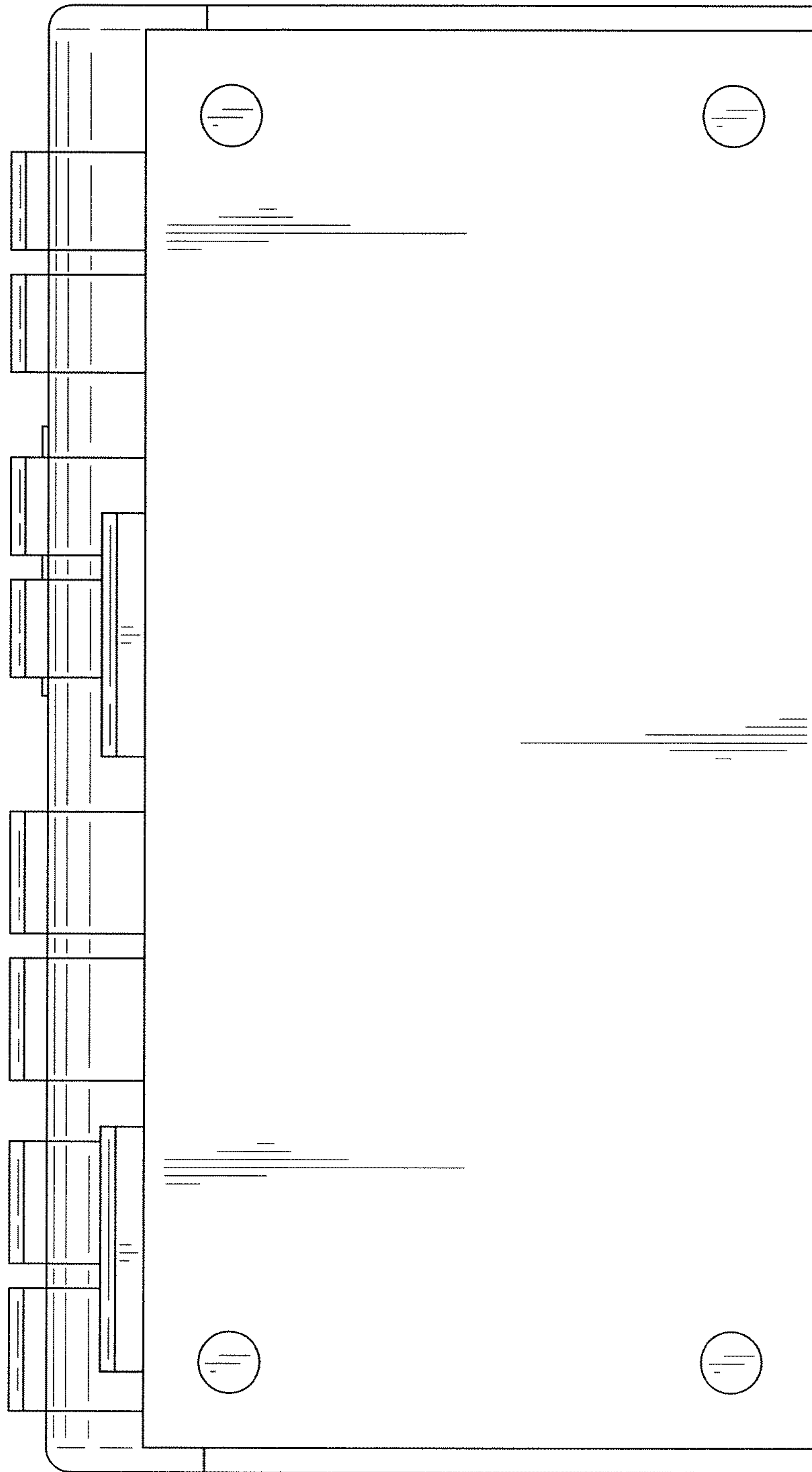

FIG. 5

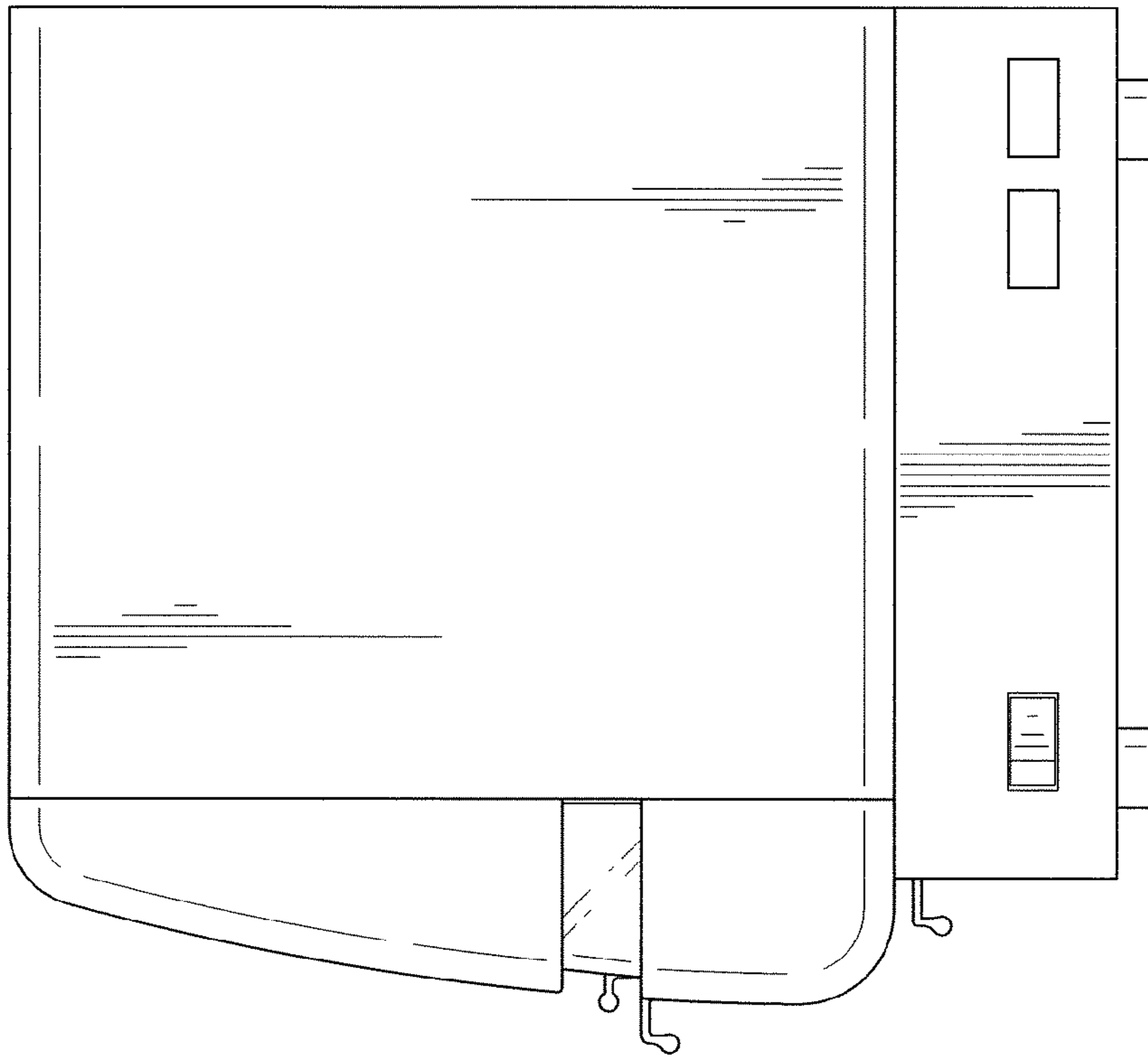

FIG. 7

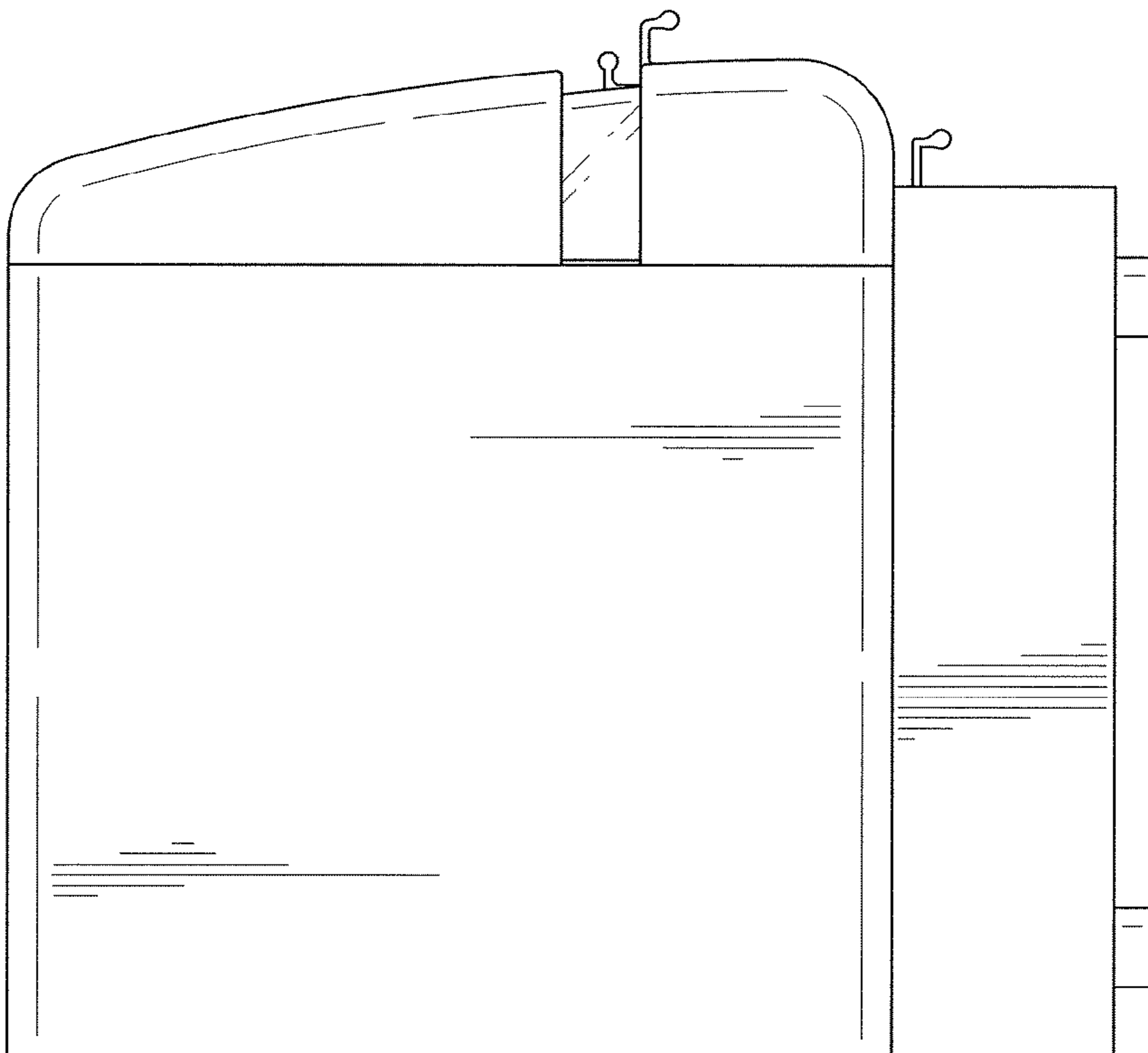

FIG. 6