



US00D638900S

(12) **United States Design Patent**
Wahnon

(10) **Patent No.:** **US D638,900 S**

(45) **Date of Patent:** **** May 31, 2011**

(54) **FLOTATION VEST**

(76) Inventor: **Samuel Wahnon**, Las Vegas, NV (US)

(**) Term: **14 Years**

(21) Appl. No.: **29/368,462**

(22) Filed: **Aug. 24, 2010**

(51) **LOC (9) Cl.** **29-02**

(52) **U.S. Cl.** **D21/805**

(58) **Field of Classification Search** D21/804,
D21/805; D29/100, 101.1, 101, 4; 2/456,
2/458, 467, 463; 441/88, 89, 106, 108, 111,
441/114-117

See application file for complete search history.

D422,665 S * 4/2000 Steger D21/805
D439,727 S 4/2001 Hosogai
D497,966 S * 11/2004 Beerwald D21/812
D530,060 S 10/2006 Quintero
D531,387 S 11/2006 Pye
D536,860 S 2/2007 Hoey
D554,225 S * 10/2007 Peterson D21/805

* cited by examiner

Primary Examiner — Zenia Bennett

(74) *Attorney, Agent, or Firm* — QuickPatents, Inc.; Kevin Prince

(57) **CLAIM**

What is claimed is the ornamental design for a flotation vest, as shown and described.

DESCRIPTION

FIG. 1 is a front perspective view of a flotation vest, showing the new design in a collapsed configuration;
FIG. 2 is a top plan view of FIG. 1;
FIG. 3 is a bottom plan view of FIG. 1;
FIG. 4 is a front elevational view of FIG. 1;
FIG. 5 is a rear elevational view of FIG. 1;
FIG. 6 is a right-side elevational view of FIG. 1;
FIG. 7 is a left-side elevational view of FIG. 1;
FIG. 8 is a left-side elevational view thereof, illustrated in an inflated configuration;
FIG. 9 is a rear elevational view of FIG. 8; and,
FIG. 10 is a rear perspective view of FIG. 8.
The broken lines in the figures are for environmental purposes only and form no part of the claimed design.

1 Claim, 4 Drawing Sheets

(56) **References Cited**

U.S. PATENT DOCUMENTS

921,352 A	5/1909	Towers	
D58,399 S	7/1921	Qua	
D149,158 S	3/1948	Wilber	
2,629,118 A	2/1953	Frieder	
D169,305 S	4/1953	Grazia	
D234,792 S *	4/1975	O'Link	D21/805
D234,793 S *	4/1975	O'Link	D21/805
D279,701 S	7/1985	Evert	
4,767,371 A	8/1988	Jackson	
D300,548 S *	4/1989	Steger	D21/805
4,973,277 A *	11/1990	Khanamirian	441/88
D361,115 S *	8/1995	Lucius	D21/805
D379,397 S *	5/1997	McMahon	D21/805
D379,839 S *	6/1997	McMahon	D21/805
D411,336 S	6/1999	Kline	

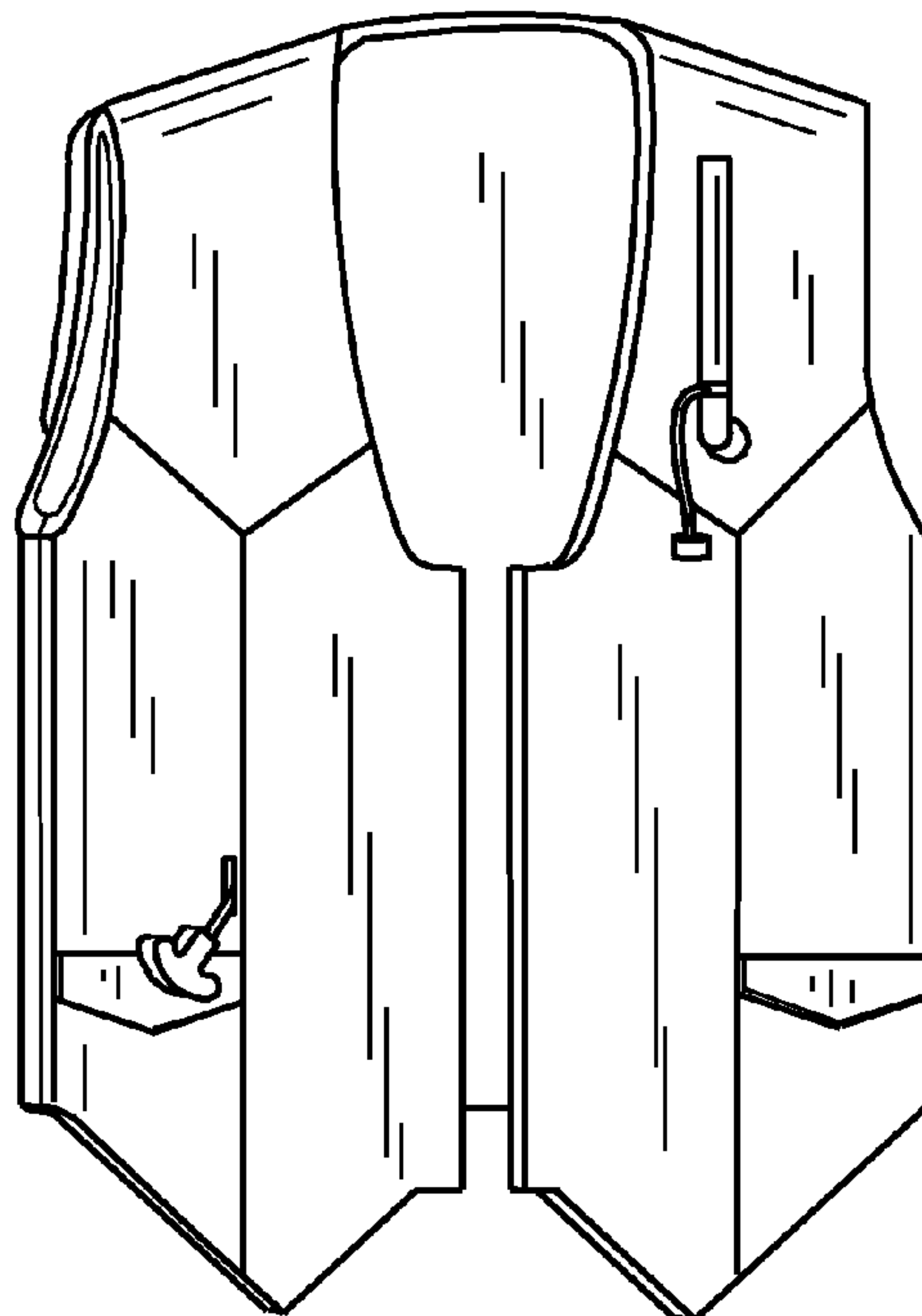

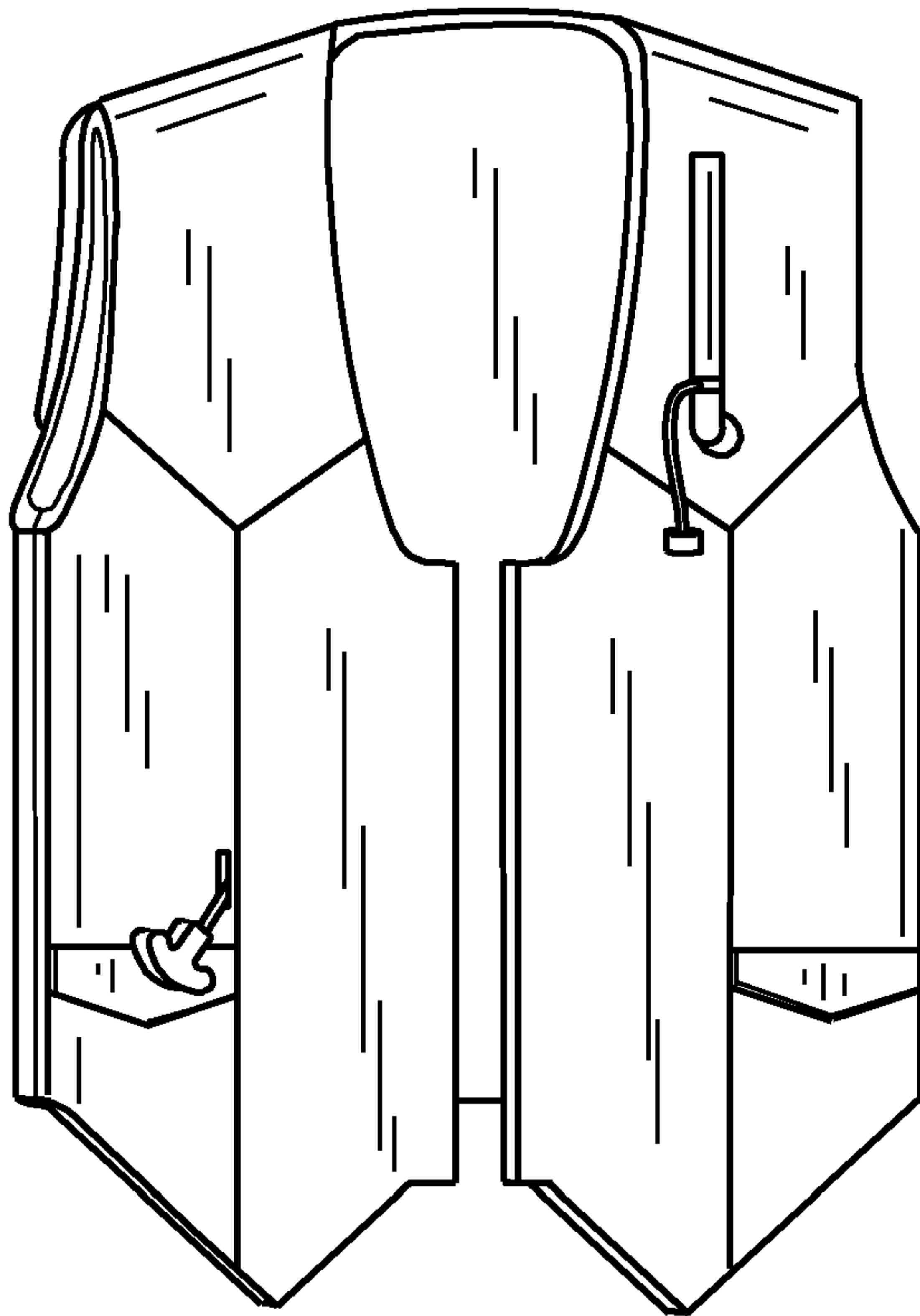

FIG. 1

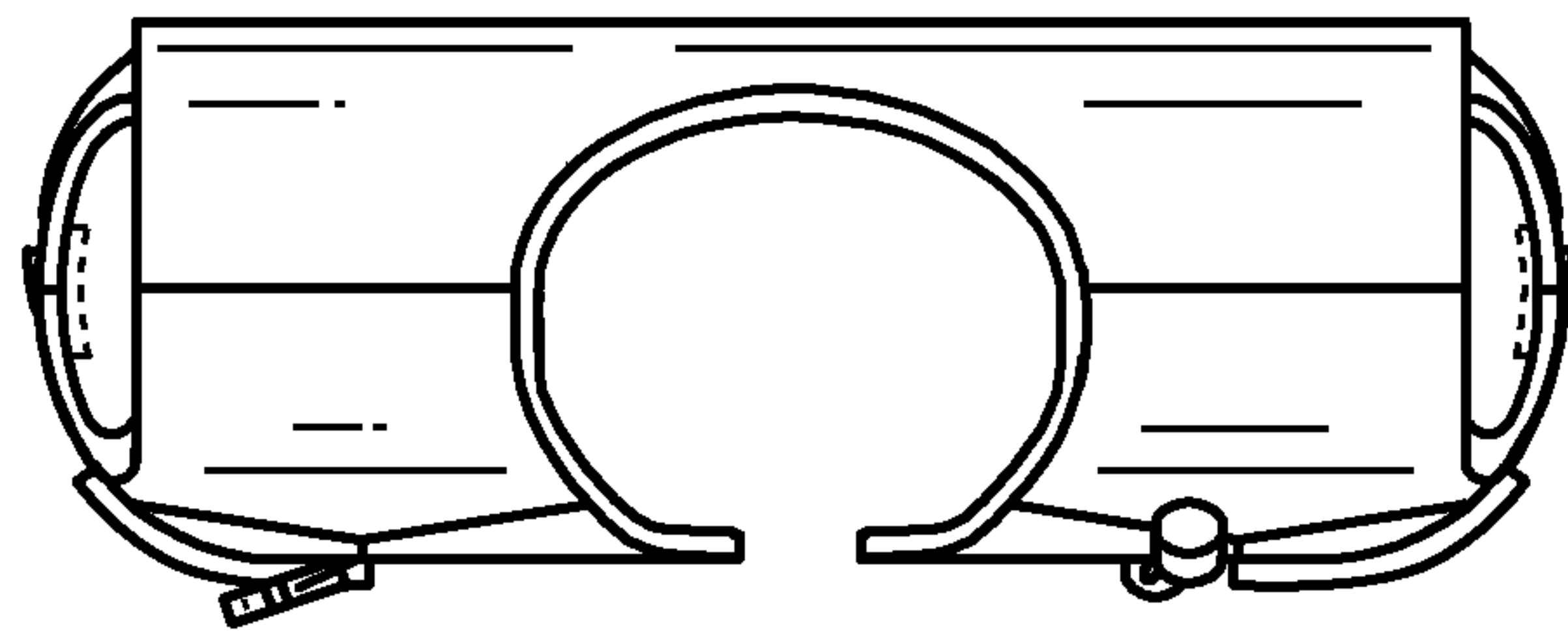

FIG. 2

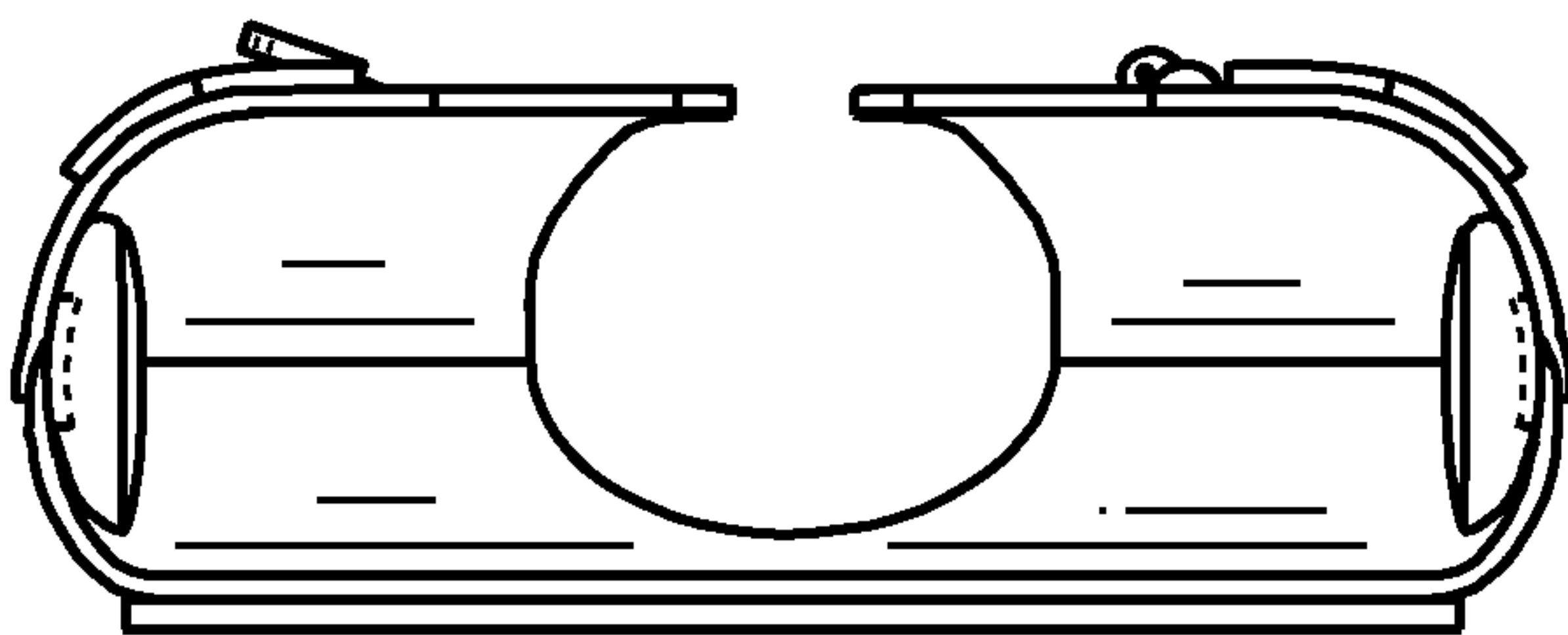

FIG. 3

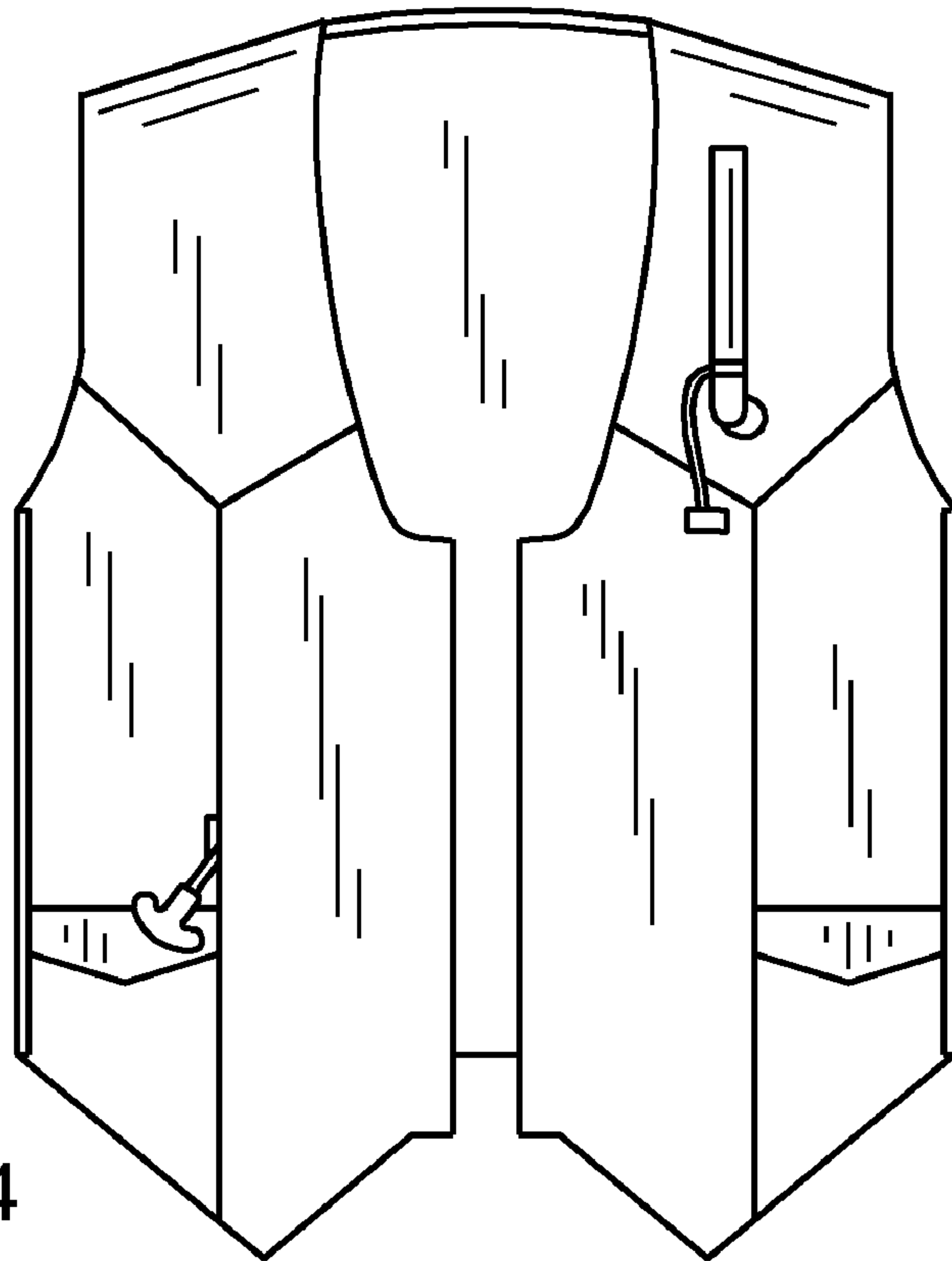

FIG. 4

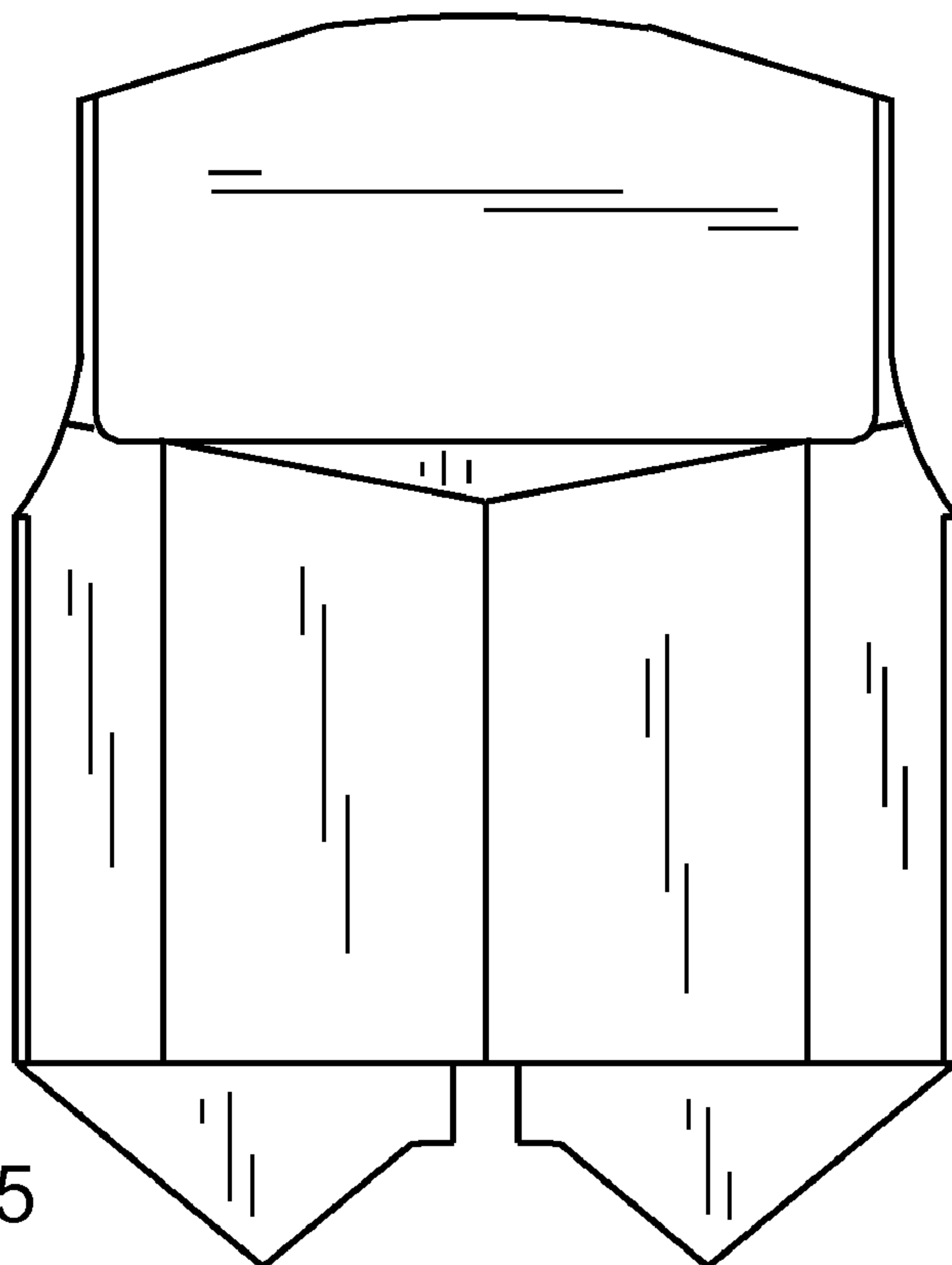

FIG. 5

FIG. 6

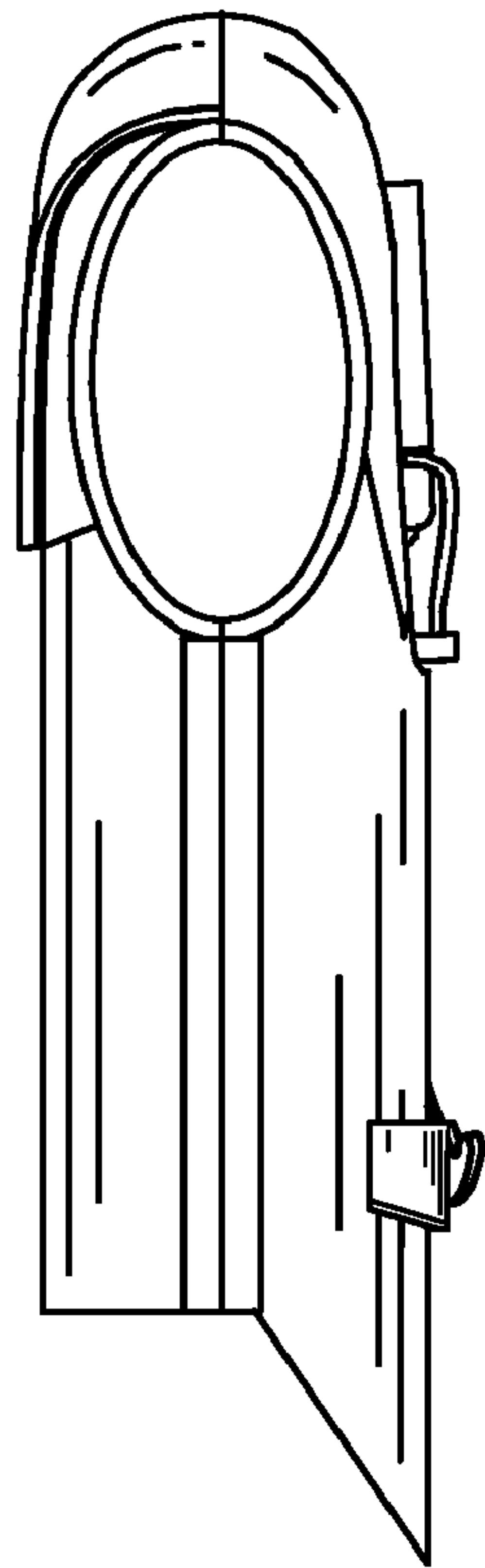

FIG. 7

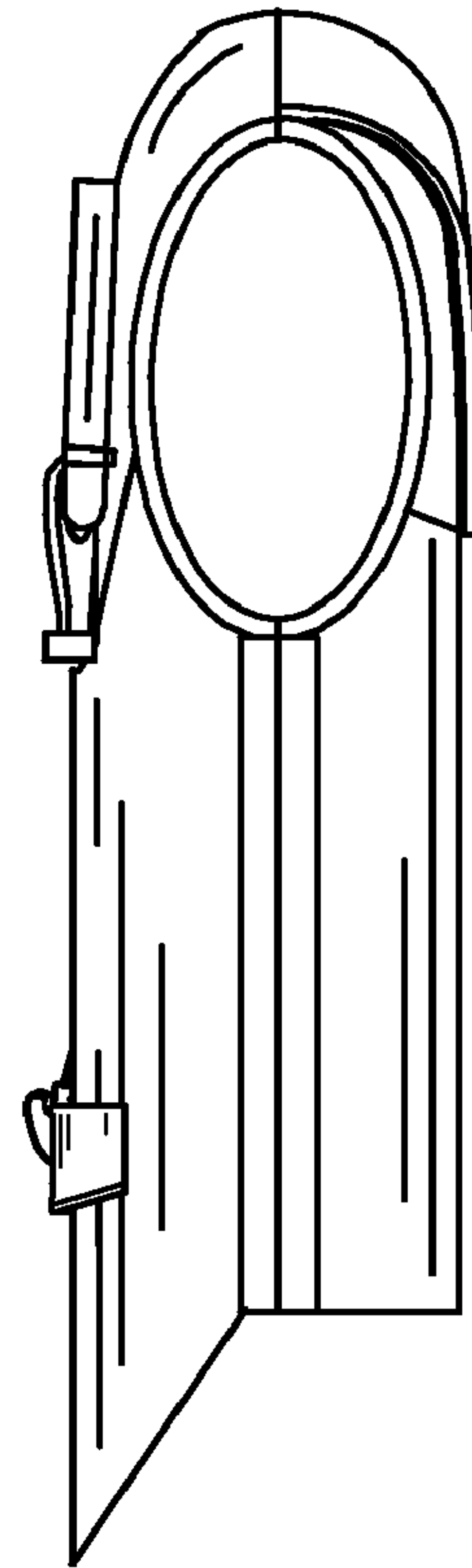
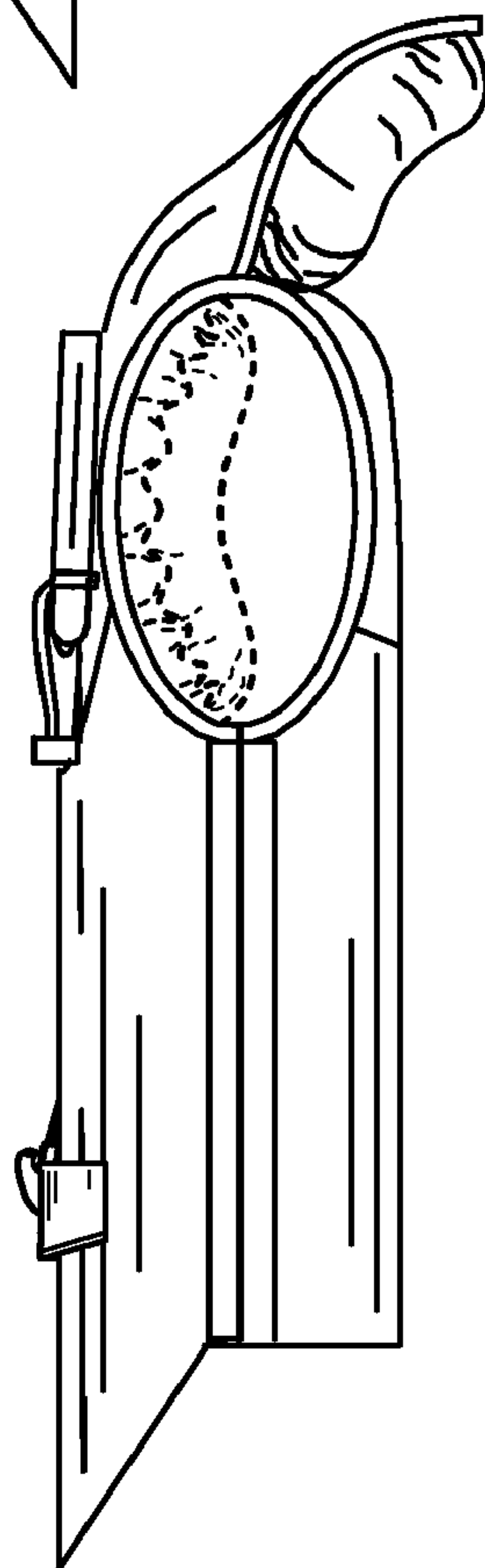

FIG. 8



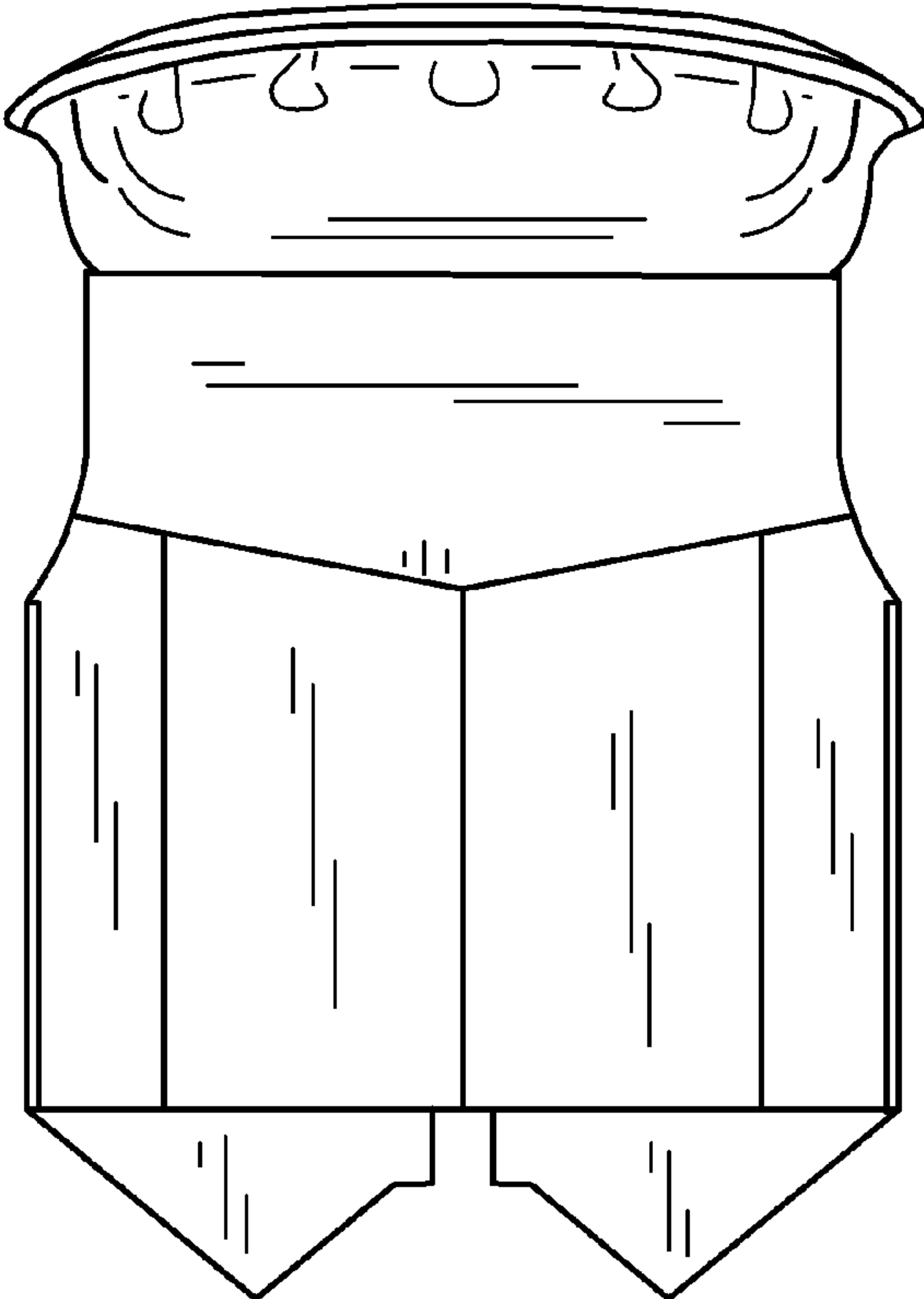

FIG. 9

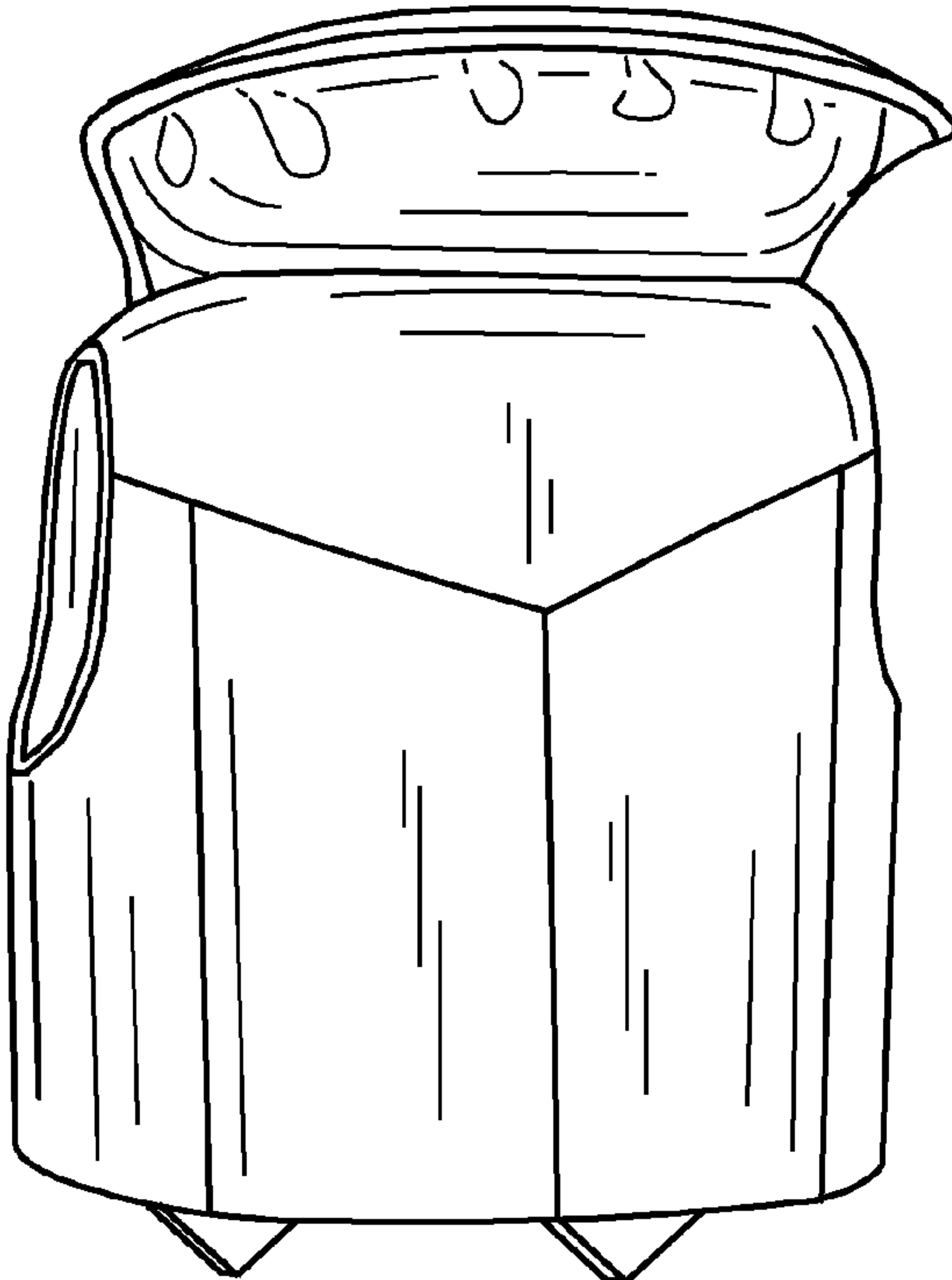

FIG. 10