



US00D638896S

(12) **United States Design Patent**  
**Schweigert et al.**

(10) **Patent No.:** **US D638,896 S**

(45) **Date of Patent:** **\*\* May 31, 2011**

(54) **GOLF CLUB HEAD**

(75) Inventors: **Bradley D. Schweigert**, Anthem, AZ (US); **Xiaojian Chen**, Phoenix, AZ (US); **Michael R. Nicolette**, Scottsdale, AZ (US)

(73) Assignee: **Karsten Manufacturing Corporation**, Phoenix, AZ (US)

(\*\*) Term: **14 Years**

(21) Appl. No.: **29/382,811**

(22) Filed: **Jan. 7, 2011**

(51) **LOC (9) Cl.** ..... **21-02**

(52) **U.S. Cl.** ..... **D21/759**

(58) **Field of Classification Search** ..... D21/733, D21/752, 759; 473/324-331

See application file for complete search history.

(56) **References Cited**

**U.S. PATENT DOCUMENTS**

1,993,928	A	3/1935	Glover
2,041,676	A	5/1936	Gallagher
D248,179	S	6/1978	Riley
4,139,196	A	2/1979	Riley
5,221,086	A	6/1993	Antonious
5,310,186	A	5/1994	Karsten
5,335,914	A	8/1994	Long
D352,755	S	11/1994	Cornish, III
D357,290	S	4/1995	Viollaz et al.
5,547,188	A	8/1996	Dumontier et al.
D379,391	S	5/1997	Moore
5,658,206	A	8/1997	Antonious
5,795,245	A	8/1998	Chang et al.
D398,682	S	9/1998	Moore
D402,340	S	12/1998	Sheets et al.
D404,098	S	1/1999	Ishikawa et al.
5,980,394	A	11/1999	Domas
D418,888	S	1/2000	Williams, Jr.
D425,589	S	5/2000	Ishikawa et al.
D426,604	S	6/2000	Besnard et al.
6,074,310	A	6/2000	Ota
6,080,069	A	6/2000	Long
D433,073	S	10/2000	Sodano

D441,818	S	5/2001	Sato
D442,245	S	5/2001	Roach et al.
D445,470	S	7/2001	Teramoto
D446,268	S	8/2001	Satoh et al.
D446,563	S	8/2001	Besnard et al.

(Continued)

*Primary Examiner* — Mitchell Siegel

(57) **CLAIM**

The ornamental design for a golf club head, as shown and described.

**DESCRIPTION**

FIG. 1 is a top perspective view of a first embodiment of an example golf club head;

FIG. 2 is a bottom perspective view of the golf club head of FIG. 1;

FIG. 3 is a front elevational view of the golf club head of FIG. 1;

FIG. 4 is a rear elevational view of the golf club head of FIG. 1;

FIG. 5 is a top view of the golf club head of FIG. 1;

FIG. 6 is a bottom view of the golf club head of FIG. 1;

FIG. 7 is a left side view of the golf club head of FIG. 1;

FIG. 8 is a right side view of the golf club head of FIG. 1;

FIG. 9 is a top perspective view of a second embodiment of an example golf club head;

FIG. 10 is a bottom perspective view of the golf club head of FIG. 9;

FIG. 11 is a front elevational view of the golf club head of FIG. 9;

FIG. 12 is a rear elevational view of the golf club head of FIG. 9;

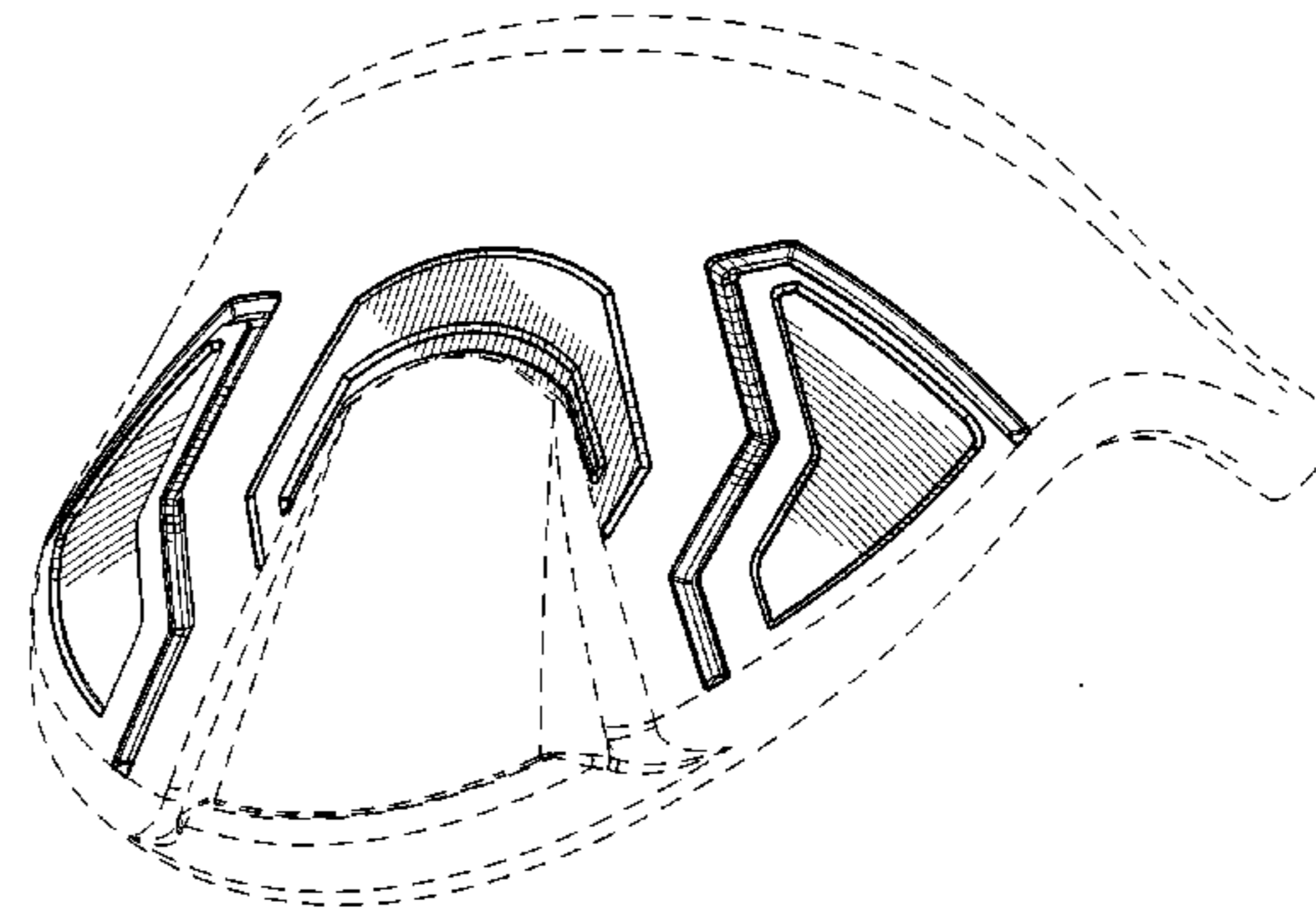
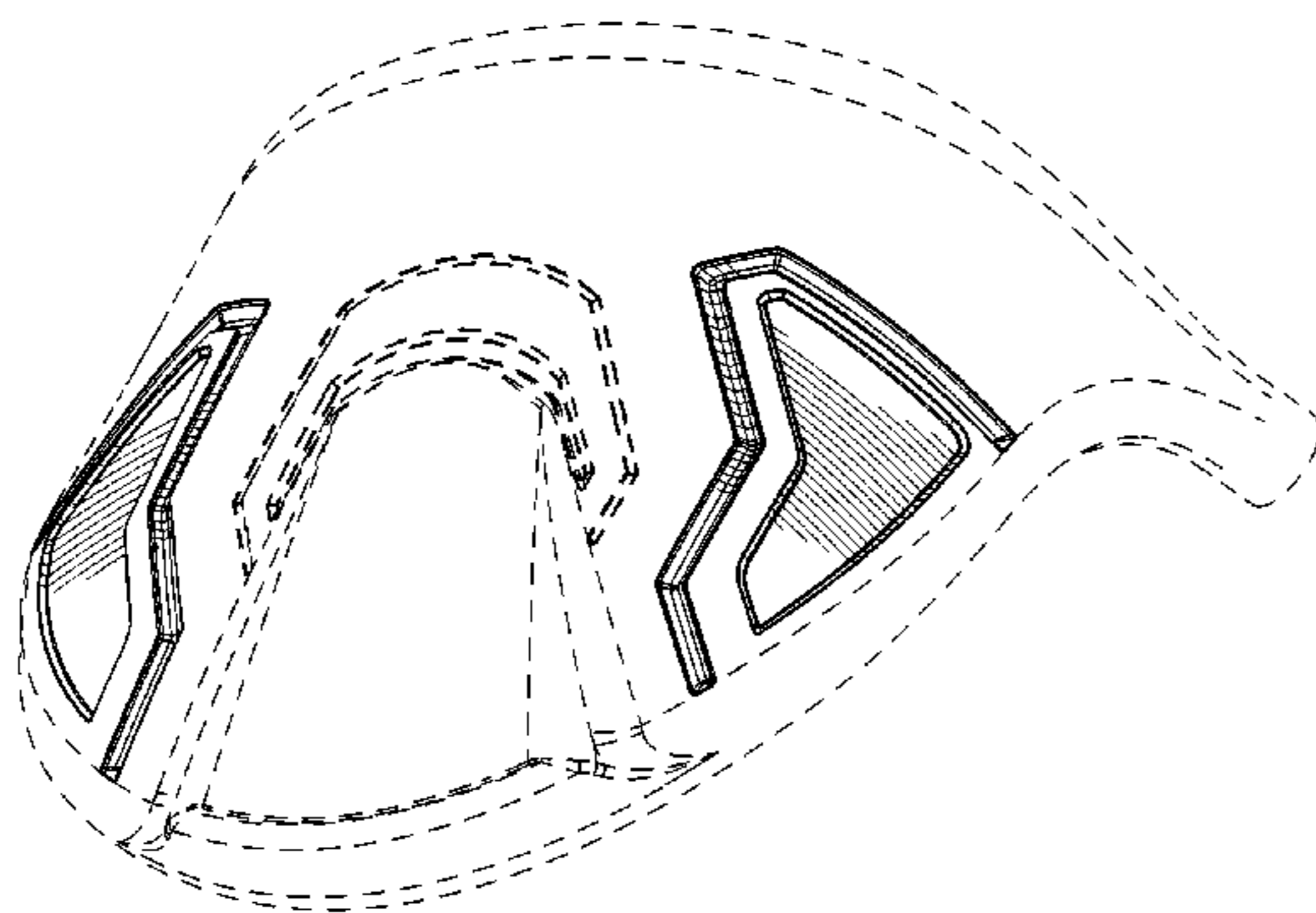
FIG. 13 is a top view of the golf club head of FIG. 9;

FIG. 14 is a bottom view of the golf club head of FIG. 9;

FIG. 15 is a left side view of the golf club head of FIG. 9; and, FIG. 16 is a right side view of the golf club head of FIG. 9.

The broken lines shown in one or more of the figures are for illustrative purposes only and form no part of the claimed design.

**1 Claim, 10 Drawing Sheets**

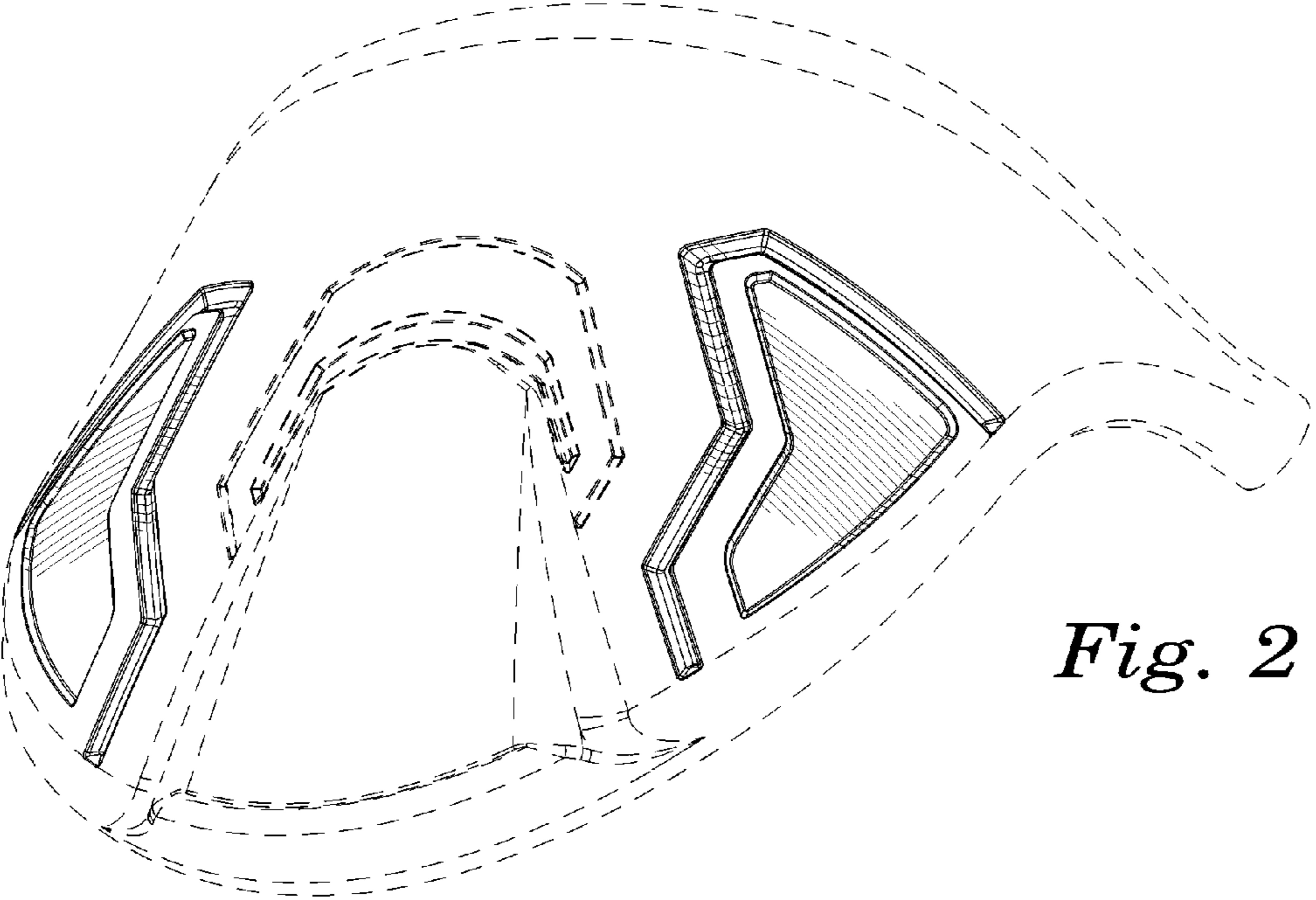
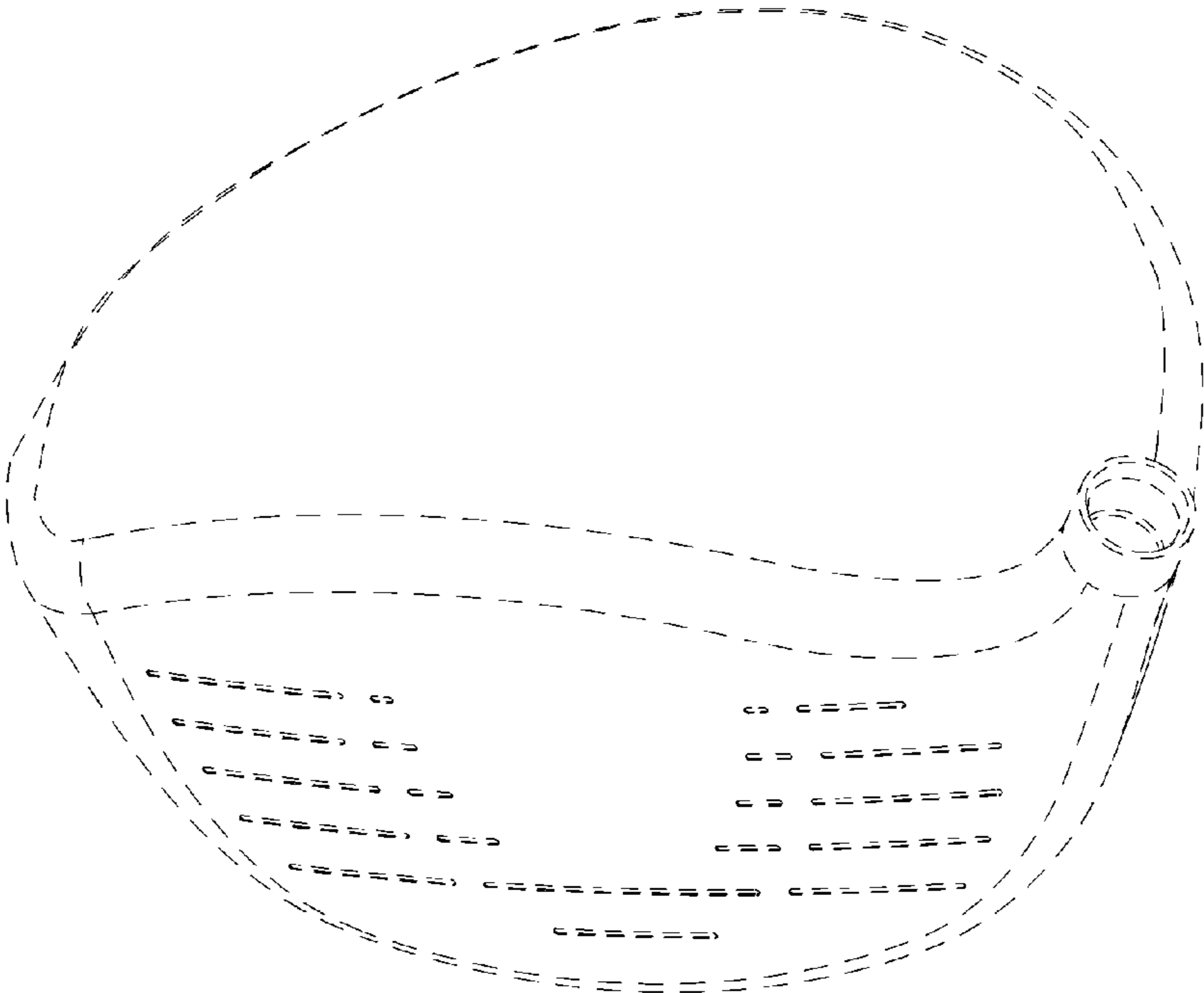


# US D638,896 S

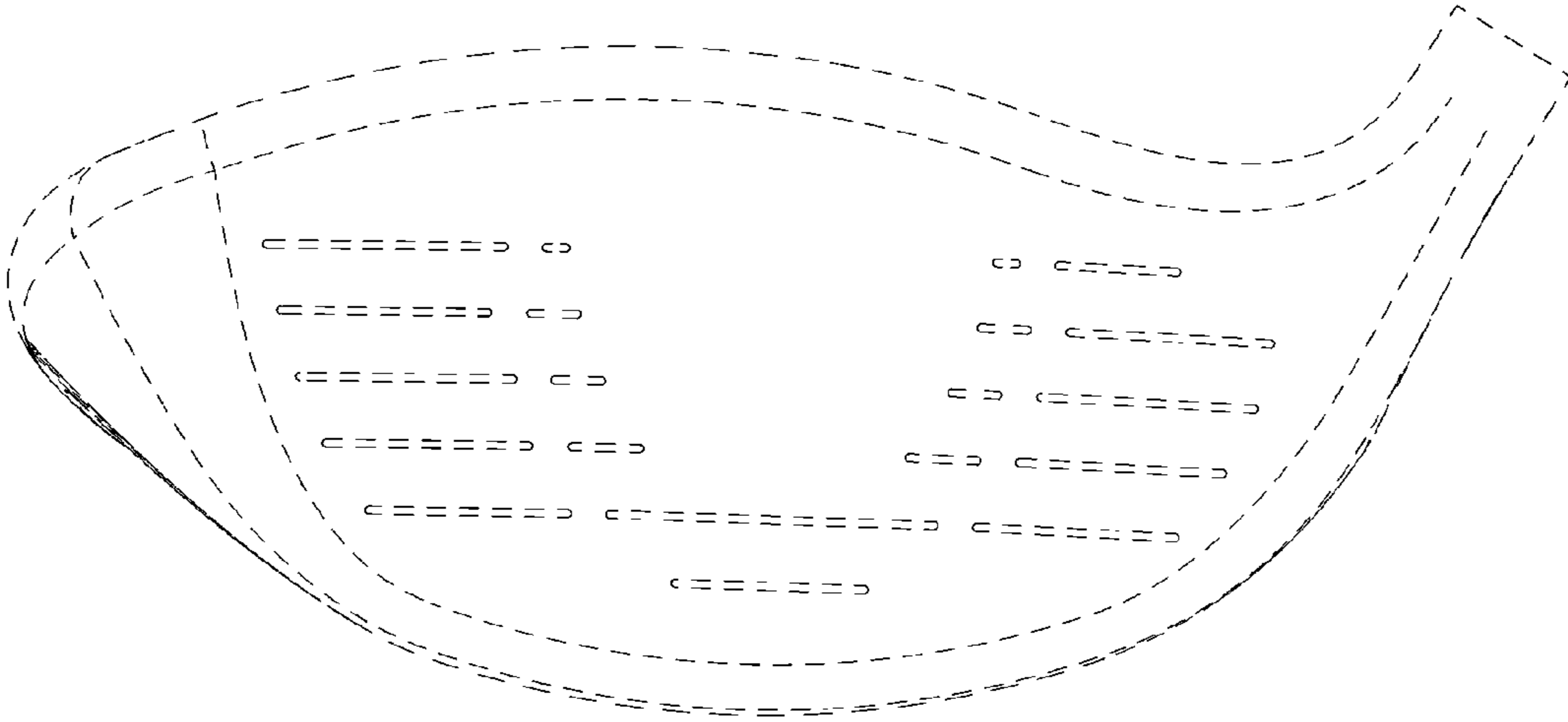
U.S. PATENT DOCUMENTS					
D461,865 S	8/2002	Nagai et al.	D570,938 S	6/2008	Jertson et al.
D463,838 S	10/2002	Besnard et al.	D570,939 S	6/2008	Chen et al.
D465,251 S	11/2002	Wood et al.	D570,940 S	6/2008	Chen et al.
6,475,102 B2	11/2002	Helmstetter et al.	D570,941 S	6/2008	Chen et al.
D469,141 S	1/2003	Poynor et al.	D571,882 S	6/2008	Sorraco
D472,950 S	4/2003	Burnett et al.	D572,324 S	7/2008	Chen et al.
D482,421 S	11/2003	Kessler	D572,782 S	7/2008	Sanchez et al.
D490,489 S	5/2004	Madore	D572,783 S	7/2008	Sanchez et al.
D492,745 S	7/2004	Tang	D572,784 S	7/2008	Sanchez et al.
D502,976 S	3/2005	Nishitani et al.	D572,785 S	7/2008	Chen et al.
D508,544 S	8/2005	Madore	D572,787 S	7/2008	Sanchez et al.
D509,272 S	9/2005	Smith et al.	D572,791 S	7/2008	Jertson et al.
6,939,247 B1	9/2005	Schweigert et al.	D573,213 S	7/2008	Sanchez et al.
D513,424 S	1/2006	Erickson et al.	D573,214 S	7/2008	Sanchez et al.
D514,179 S	1/2006	Chen et al.	D573,215 S	7/2008	Sanchez et al.
6,988,960 B2	1/2006	Mahaffey et al.	D573,216 S	7/2008	Sanchez et al.
D518,129 S	3/2006	Poynor et al.	D573,217 S	7/2008	Sanchez et al.
D518,543 S	4/2006	Aguinaldo et al.	D573,218 S	7/2008	Sanchez et al.
D521,093 S	5/2006	Jorgensen et al.	D573,674 S	7/2008	Sanchez et al.
D522,077 S	5/2006	Schweigert et al.	D573,675 S	7/2008	Sanchez et al.
D522,601 S	6/2006	Schweigert et al.	D573,676 S	7/2008	Chen et al.
D523,103 S	6/2006	Hocknell et al.	D573,678 S	7/2008	Kawami
D523,498 S	6/2006	Chen et al.	D574,046 S	7/2008	Chen et al.
D523,502 S	6/2006	Jorgensen	D574,048 S	7/2008	Kadoya
D526,694 S	8/2006	Schweigert et al.	D574,049 S	7/2008	Kadoya
D529,111 S	9/2006	Cleveland et al.	D574,050 S	7/2008	Jones et al.
D530,761 S	10/2006	Evans et al.	7,396,296 B2	7/2008	Evans
D532,473 S	11/2006	Chen et al.	D574,456 S	8/2008	Chen et al.
D532,474 S	11/2006	Bennett et al.	D578,587 S	10/2008	Hoffman et al.
D532,854 S	11/2006	Oldknow	D579,066 S	10/2008	Dipert et al.
D535,343 S	1/2007	Chen et al.	D579,067 S	10/2008	Hoffman et al.
D536,049 S	1/2007	Evans et al.	D580,504 S	11/2008	Bosilkovski et al.
D537,139 S	2/2007	Breier et al.	D583,432 S	12/2008	Serrano et al.
D537,495 S	2/2007	Schweigert et al.	D587,772 S	3/2009	Ferguson et al.
D537,496 S	2/2007	Serrano et al.	D588,217 S	3/2009	Jertson et al.
D537,895 S	3/2007	Breier et al.	D588,659 S	3/2009	Jertson et al.
D538,363 S	3/2007	Schweigert et al.	D589,576 S	3/2009	Kadoya
D538,367 S	3/2007	Foster et al.	7,503,854 B2	3/2009	Galloway et al.
D538,371 S *	3/2007	Kawami ..... D21/759	D591,810 S *	5/2009	Murphy et al. .... D21/752
D538,866 S	3/2007	Kim et al.	D591,816 S *	5/2009	Vehse et al. .... D21/759
D538,867 S	3/2007	Cleveland et al.	D591,817 S *	5/2009	Murphy et al. .... D21/759
D539,371 S	3/2007	Chen et al.	D591,818 S	5/2009	Roberts et al.
D550,318 S	9/2007	Oldknow	D594,518 S	6/2009	Schweigert
D550,799 S	9/2007	Lin	D594,520 S *	6/2009	Schweigert et al. .... D21/759
D552,198 S	10/2007	Schweigert et al.	D594,521 S	6/2009	Jertson et al.
D553,206 S	10/2007	Morales et al.	D594,919 S	6/2009	Schweigert et al.
D555,745 S	11/2007	Rollinson et al.	D596,252 S	7/2009	Jertson et al.
D557,362 S	12/2007	Serrano et al.	D598,062 S *	8/2009	Dipert et al. .... D21/752
D557,363 S	12/2007	Jertson et al.	D600,297 S	9/2009	Jertson et al.
D558,287 S	12/2007	Jertson et al.	D603,472 S	11/2009	Schweigert et al.
D558,288 S	12/2007	Jertson et al.	D603,919 S *	11/2009	Gray et al. .... D21/752
D561,286 S	2/2008	Morales et al.	D604,376 S *	11/2009	Darley et al. .... D21/752
D562,421 S	2/2008	Jertson et al.	D609,293 S	2/2010	Williams
7,326,472 B2	2/2008	Shimazaki et al.	D609,294 S	2/2010	Oldknow
D563,498 S	3/2008	Jertson et al.	D611,555 S	3/2010	Oldknow
D564,054 S	3/2008	Jertson et al.	D612,005 S	3/2010	Oldknow
D564,055 S	3/2008	Jertson et al.	D613,805 S	4/2010	Sutovsky et al.
D564,056 S	3/2008	Chen et al.	D614,711 S *	4/2010	Harbert et al. .... D21/752
D566,214 S	4/2008	Evans et al.	D618,747 S	6/2010	Schweigert et al.
D567,317 S	4/2008	Jertson et al.	D618,753 S *	6/2010	Jertson et al. .... D21/759
D567,891 S	4/2008	Serrano et al.	D618,754 S	6/2010	Schweigert et al.
D569,933 S	5/2008	Jertson et al.	D627,842 S *	11/2010	Gray et al. .... D21/759
D569,934 S	5/2008	Jertson et al.	2005/0043117 A1	2/2005	Gilbert et al.
D569,935 S	5/2008	Schweigert et al.	2008/0039228 A1	2/2008	Breier et al.
D569,936 S	5/2008	Schweigert et al.	2008/0153625 A1	6/2008	Morales et al.
D569,937 S	5/2008	Sanchez et al.	2008/0171612 A1	7/2008	Serrano et al.
D569,938 S	5/2008	Sanchez et al.	2008/0188322 A1	8/2008	Anderson et al.
D570,937 S	6/2008	Schweigert et al.	2009/0275419 A1	11/2009	Cackett et al.

\* cited by examiner

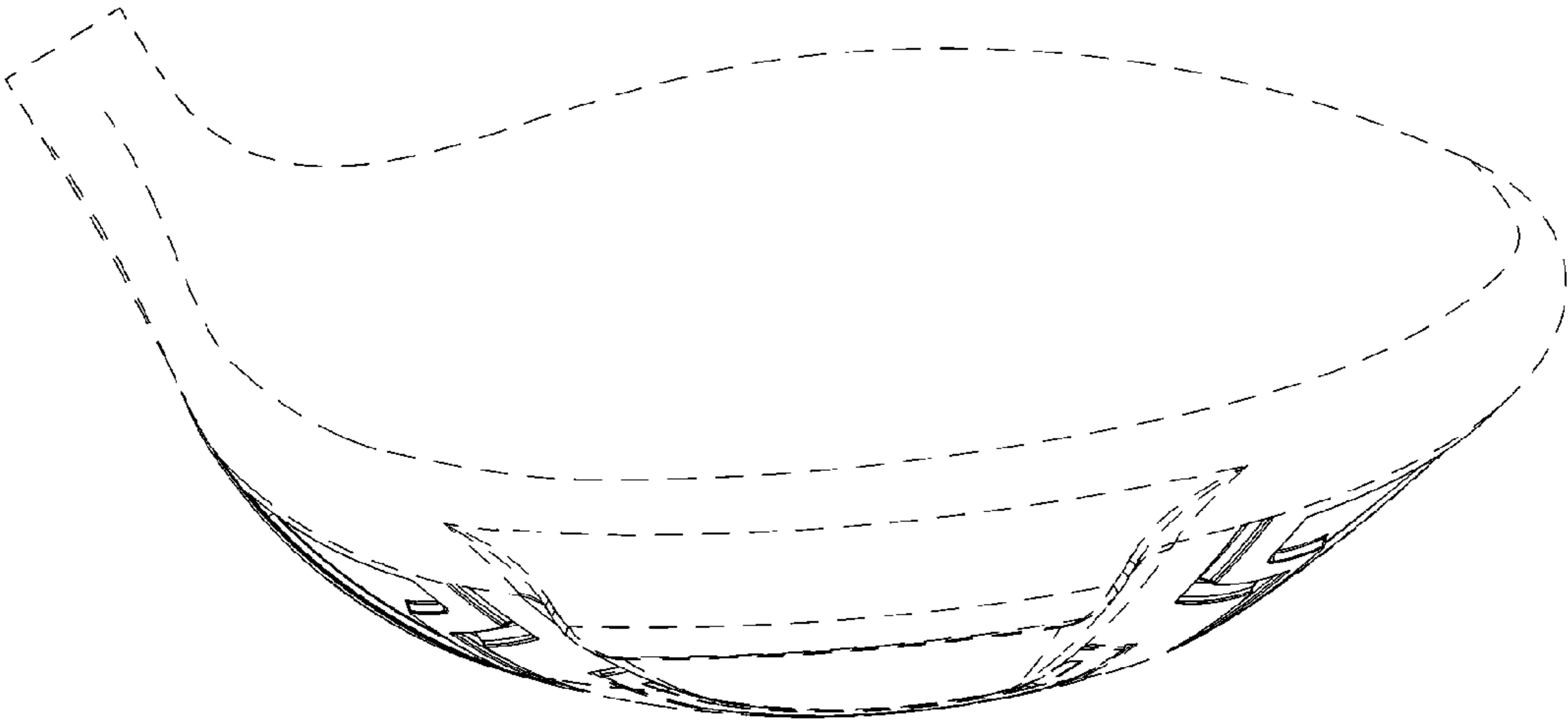
*Fig. 1*



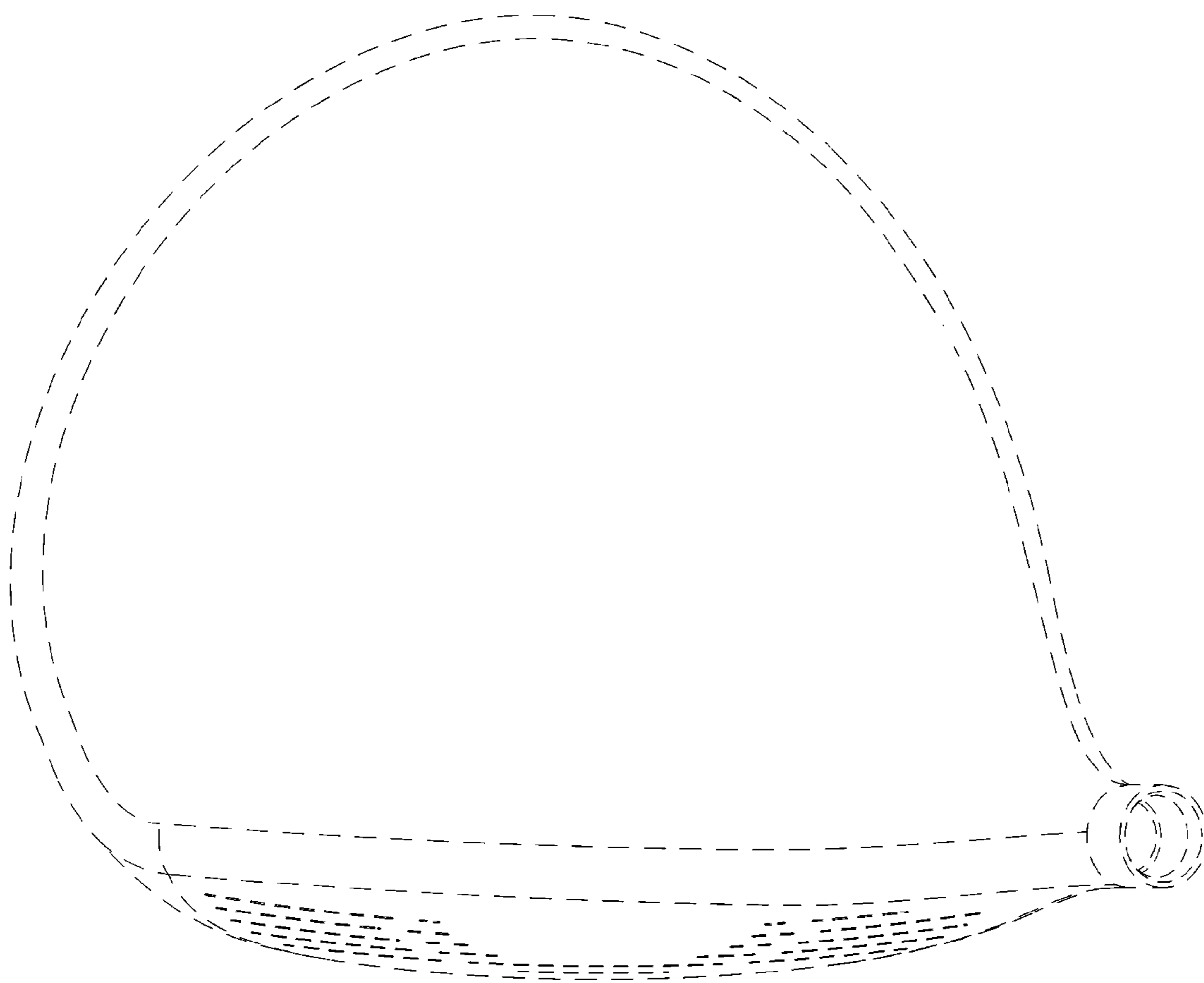
*Fig. 2*



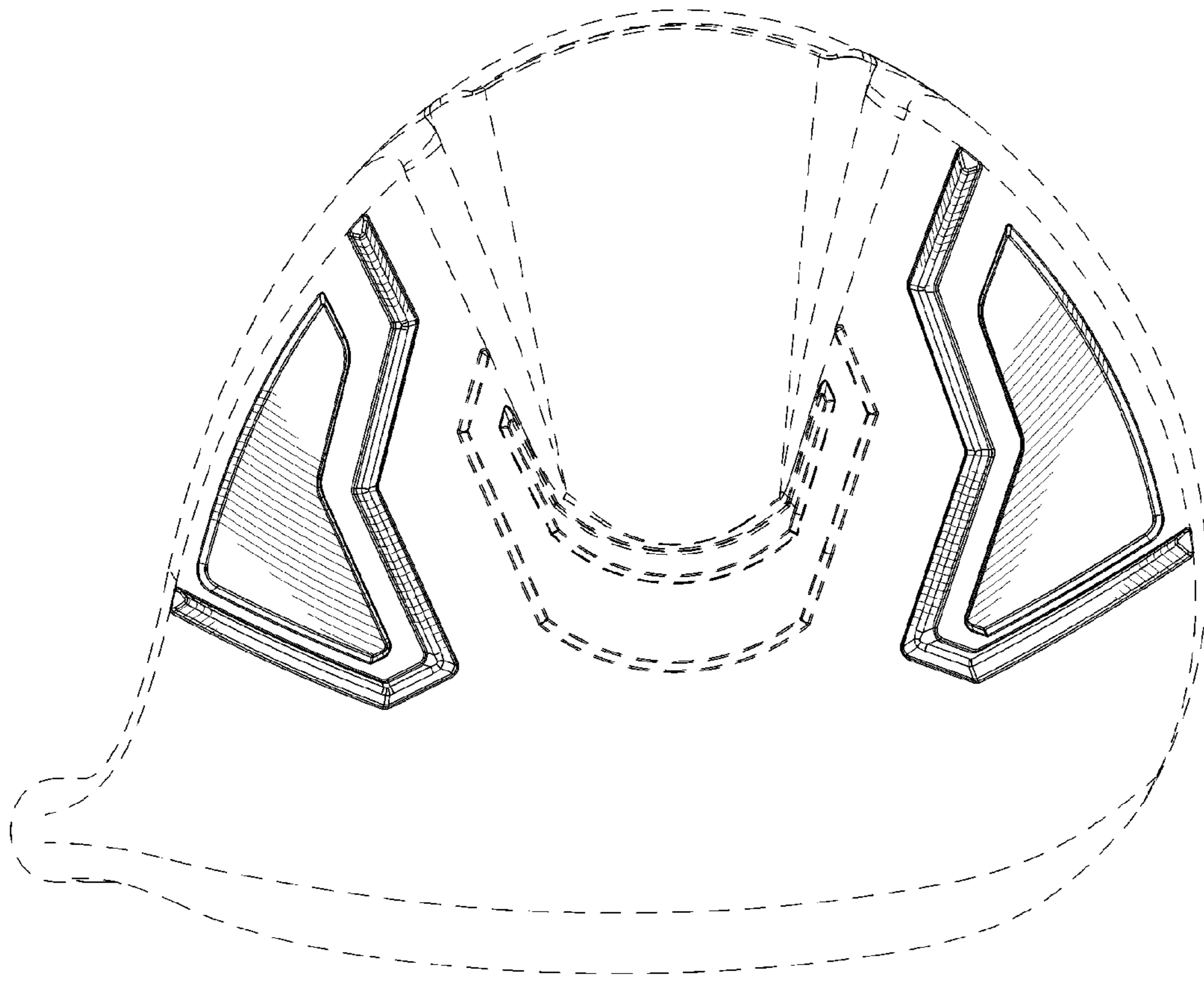
*Fig. 3*



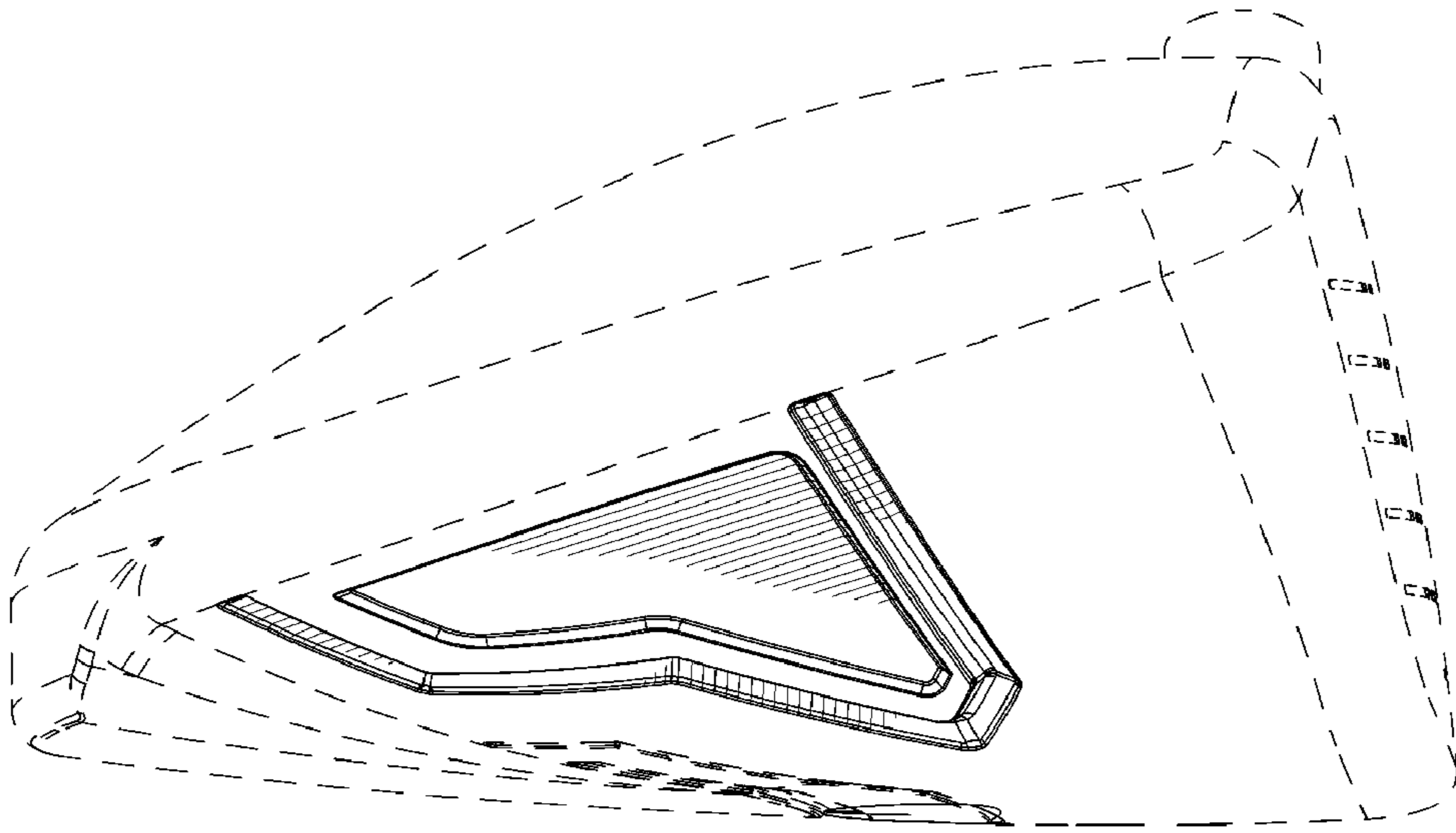
*Fig. 4*



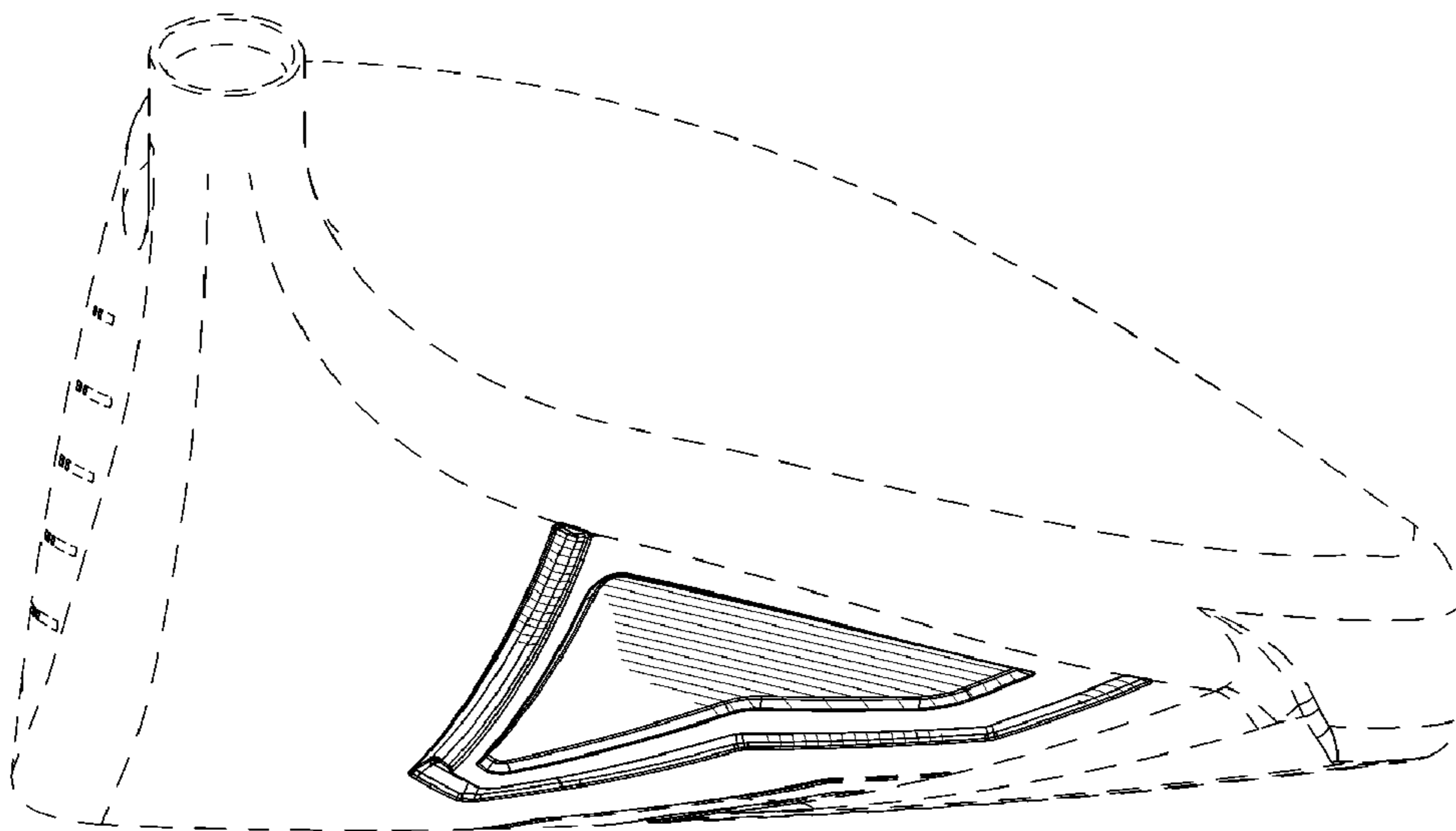
*Fig. 5*



*Fig. 6*

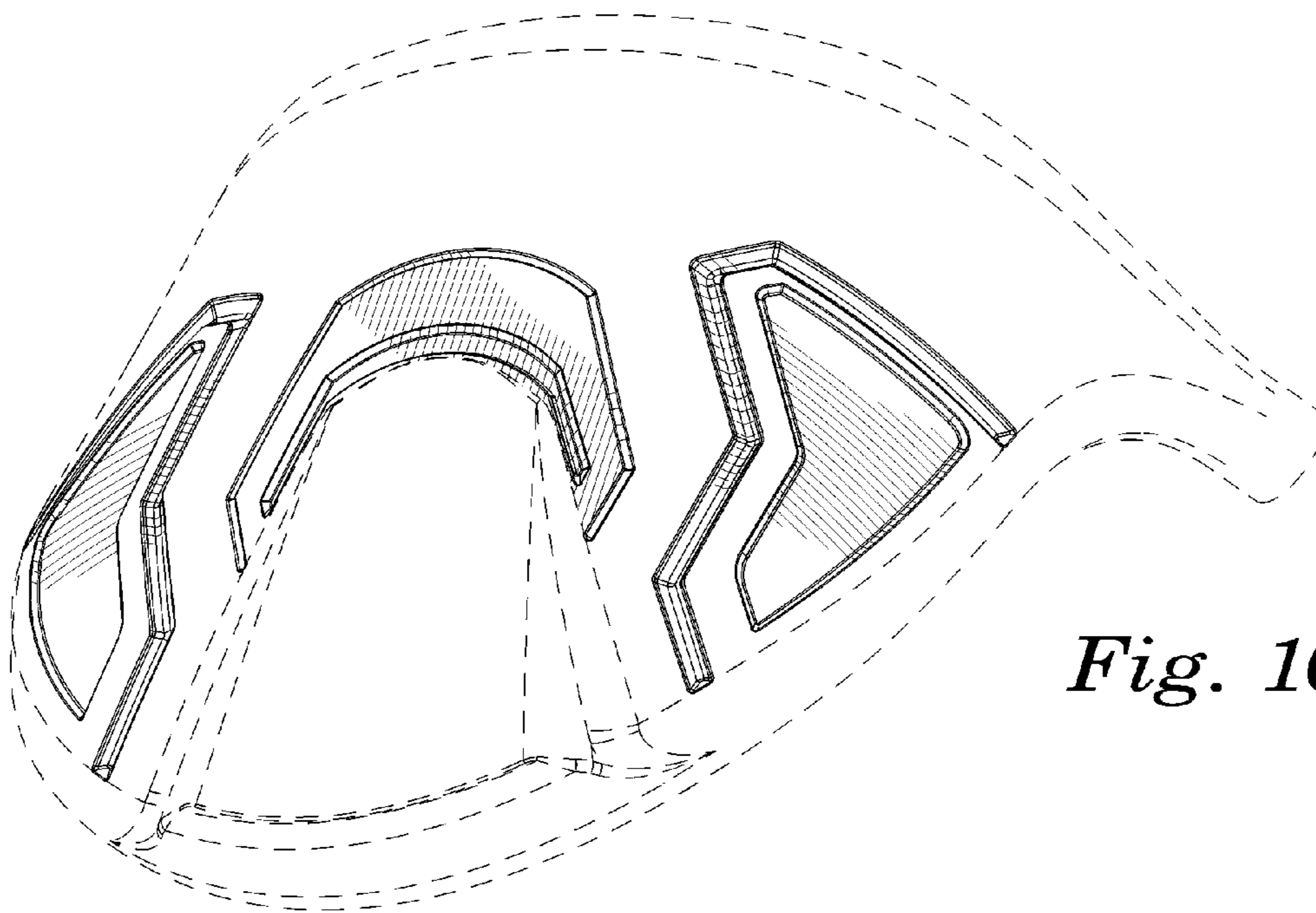
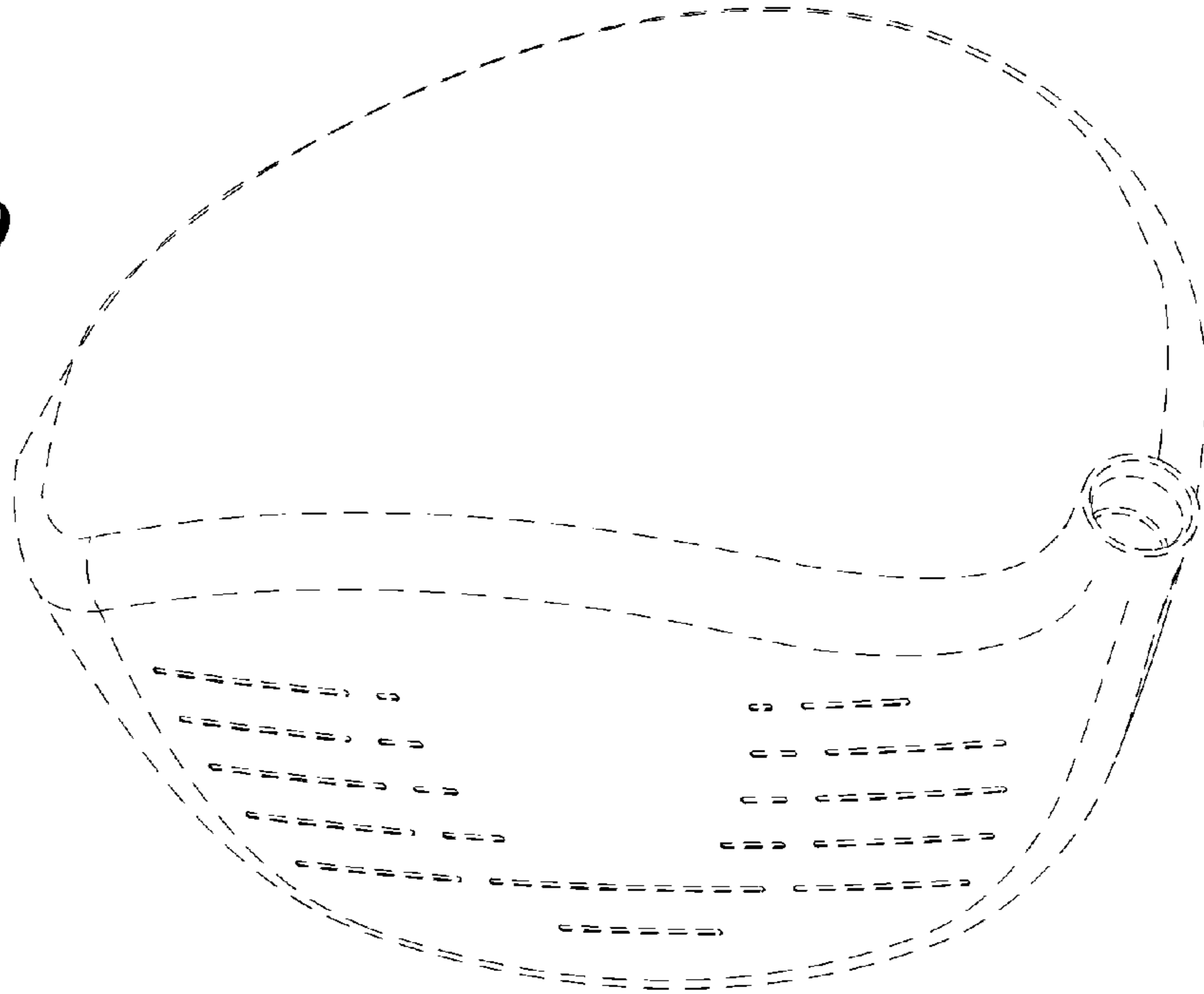


*Fig. 7*



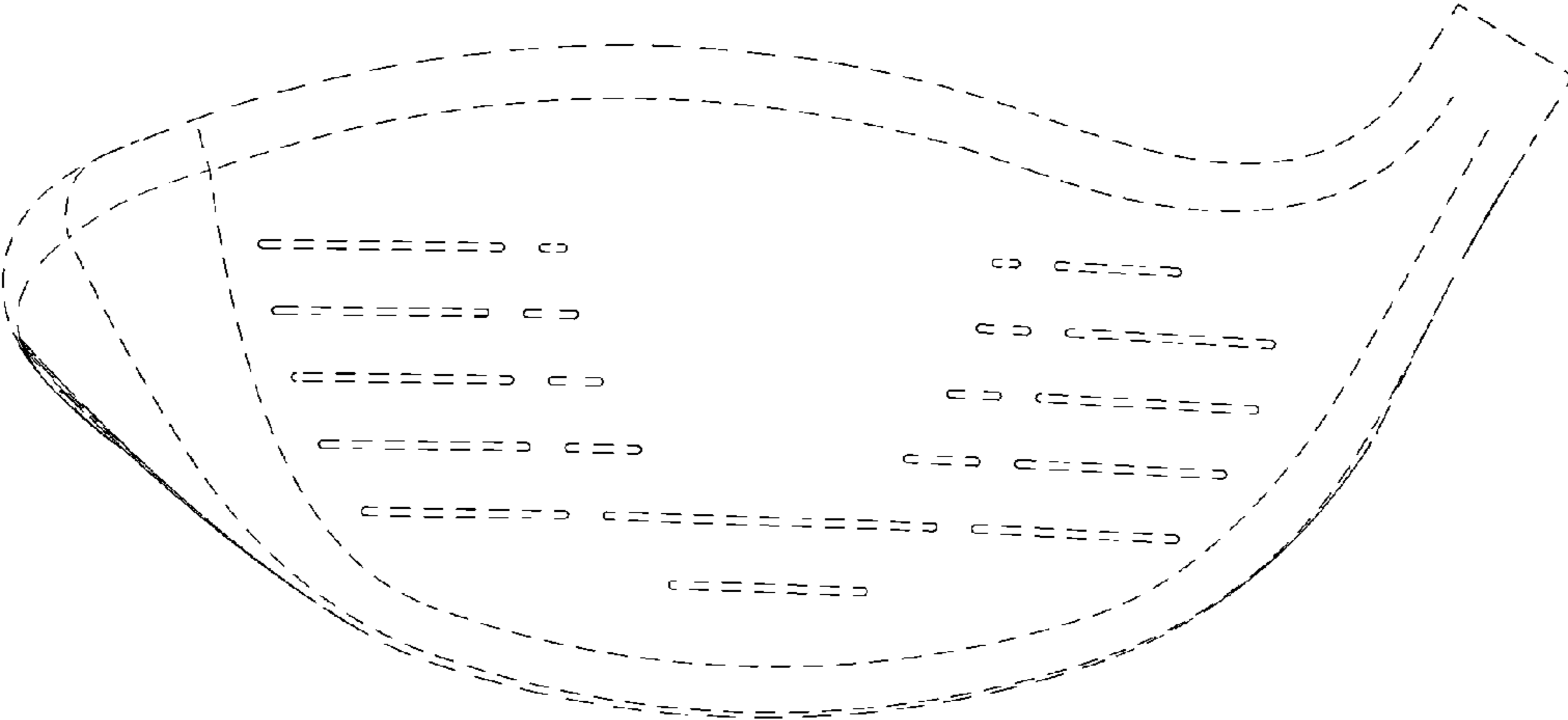
*Fig. 8*

*Fig. 9*

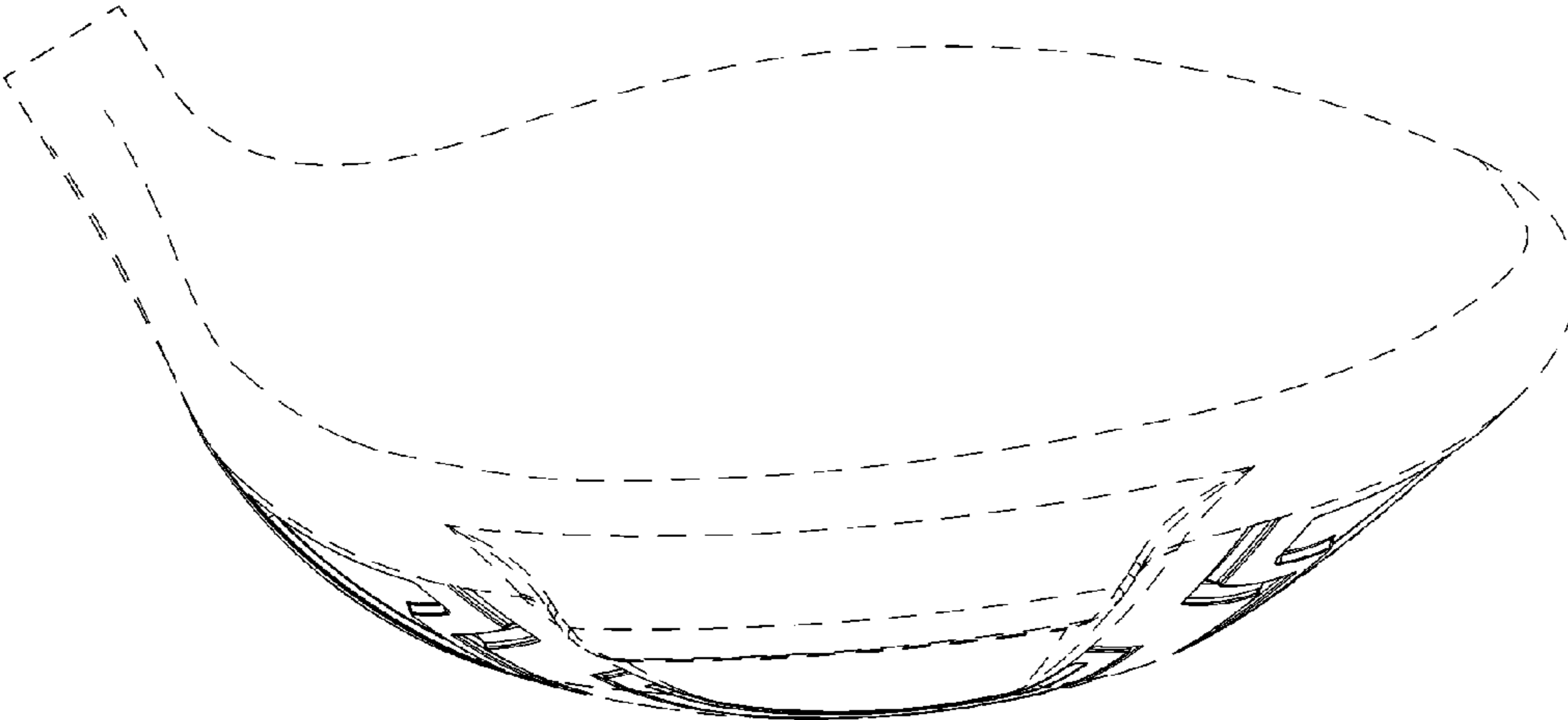


*Fig. 10*

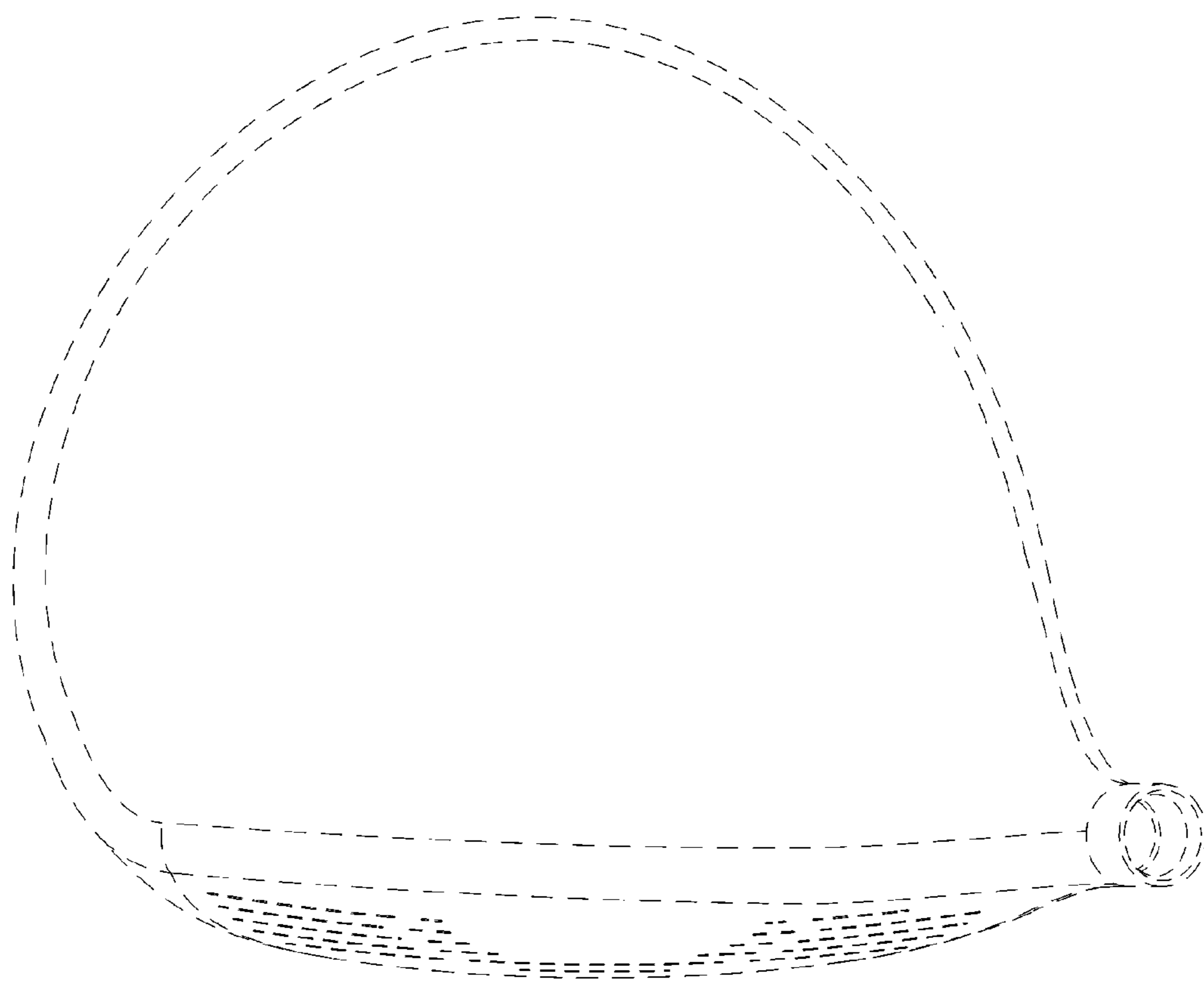




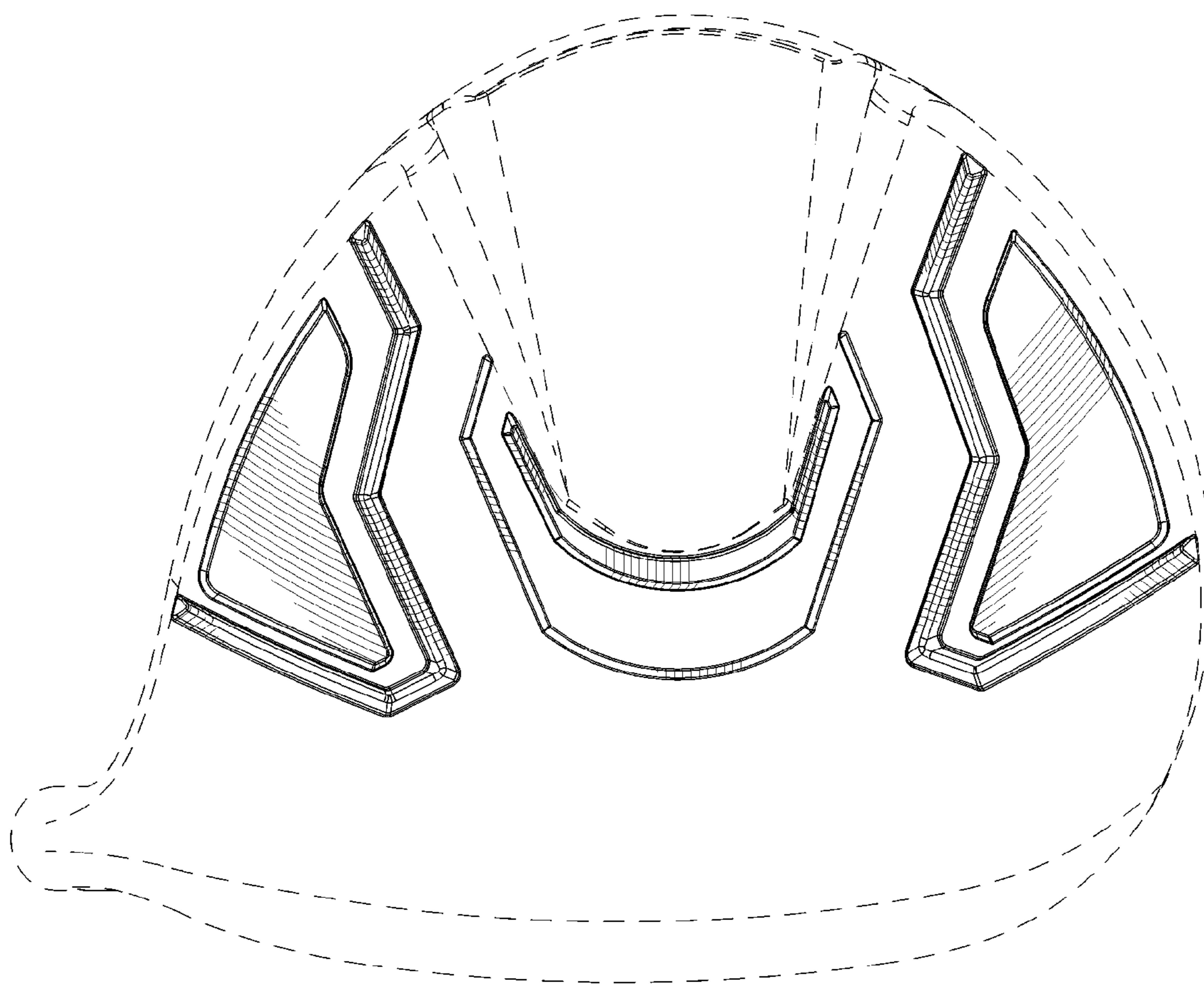
*Fig. 11*



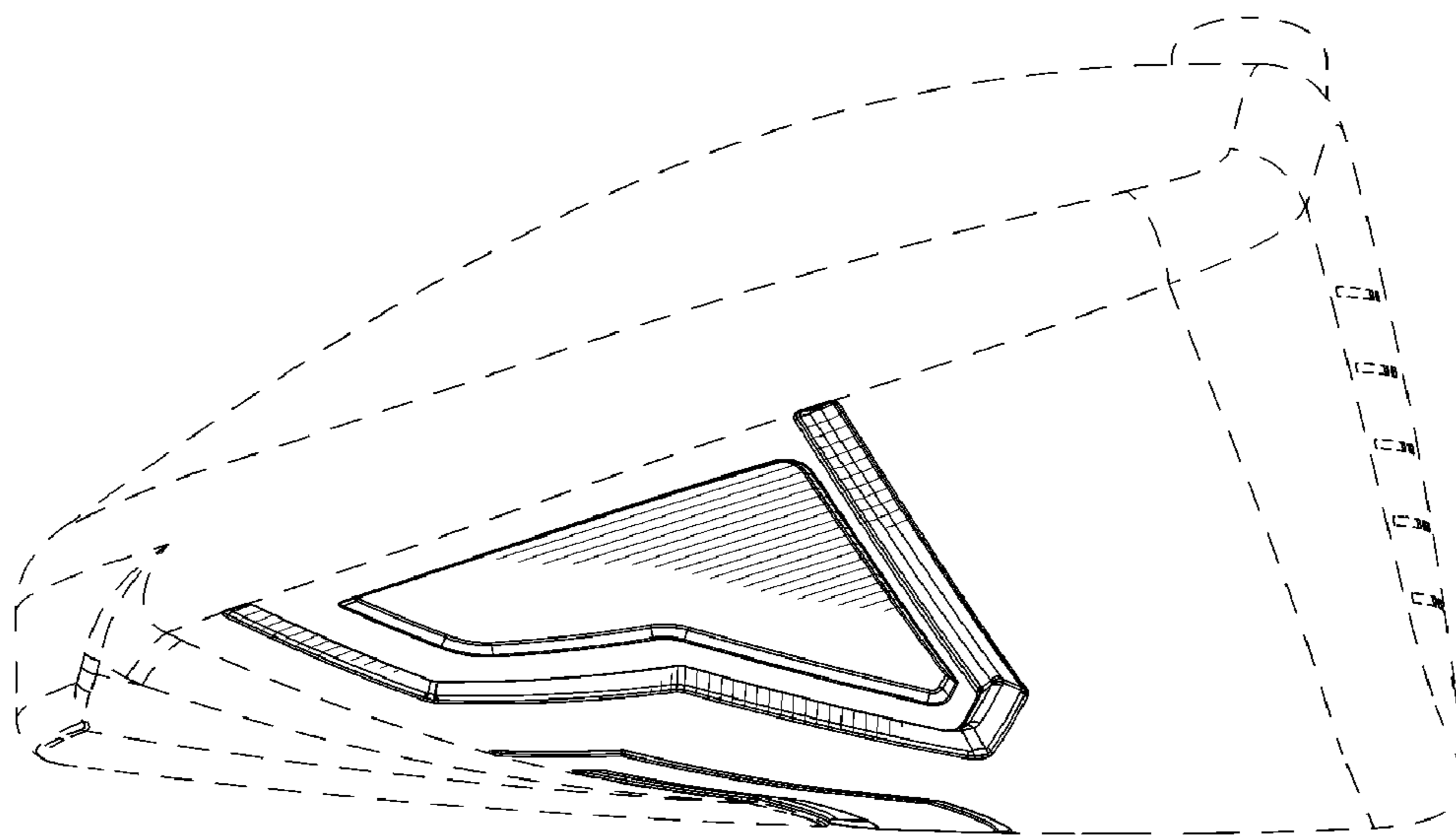
*Fig. 12*



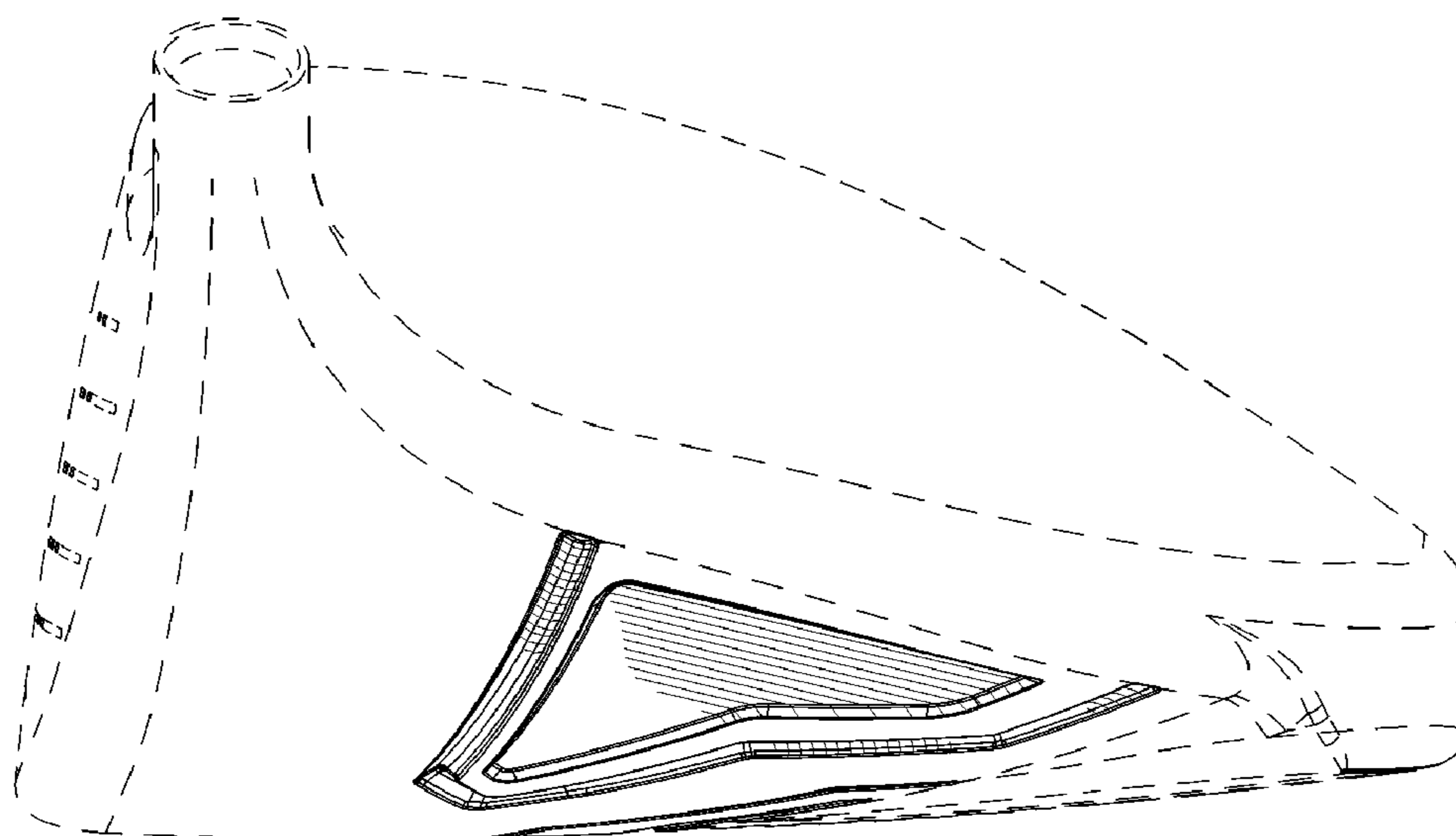
*Fig. 13*



*Fig. 14*



*Fig. 15*



*Fig. 16*