



US00D638877S

(12) **United States Design Patent**
Sheldon

(10) **Patent No.:** **US D638,877 S**

(45) **Date of Patent:** **** May 31, 2011**

(54) **EYEWEAR**

(76) Inventor: **Brent Sheldon**, Montreal (CA)

(**) Term: **14 Years**

(21) Appl. No.: **29/313,087**

(22) Filed: **Dec. 5, 2008**

(51) **LOC (9) Cl.** **16-06**

(52) **U.S. Cl.** **D16/326**

(58) **Field of Classification Search** D16/101,
D16/300-342; D29/109, 110; D24/110.2;
351/41, 44, 45, 46, 51, 52, 61, 62, 92, 103-123,
351/130, 140, 153, 158, 138; 2/13, 15, 426-432,
2/441, 434-437, 447-449; D21/483, 659-661

See application file for complete search history.

U.S. Appl. No. 29/308,132 Applicant: Sheldon, Brent.
U.S. Appl. No. 29/308,430 Applicant: Sheldon, Brent.
U.S. Appl. No. 29/310,996 Applicant: Sheldon, Brent.
U.S. Appl. No. 29/342,207 Applicant: Sheldon, Brent.
U.S. Appl. No. 29/342,209 Applicant: Sheldon, Brent.
U.S. Appl. No. 29/350,393 Applicant: Sheldon, Brent.
U.S. Appl. No. 29/350,394 Applicant: Sheldon, Brent.

* cited by examiner

Primary Examiner — Raphael Barkai

Assistant Examiner — Randall Gholson

(74) *Attorney, Agent, or Firm* — Powley & Gibson, P.C.

(57) **CLAIM**

I claim the ornamental design for eyewear, as shown and described.

(56) **References Cited**

U.S. PATENT DOCUMENTS

D435,579	S	*	12/2000	Lane	D16/327
D456,441	S	*	4/2002	Jannard et al.	D16/326
D470,882	S	*	2/2003	Mage	D16/326
D500,781	S	*	1/2005	Mage	D16/326
7,192,133	B1	*	3/2007	Yang	351/44
D544,019	S	*	6/2007	Lane	D16/319
7,278,733	B2	*	10/2007	Olney	351/62
7,452,071	B2	*	11/2008	Daems et al.	351/111

FOREIGN PATENT DOCUMENTS

EM	001021158-0001	A1	1/2009
EM	001021158-0002	A1	1/2009
EM	001021158-0003	A1	1/2009
EM	001021158-0004	A1	1/2009
EM	001110217-0001	A1	7/2009
EM	001143226-0001	A1	8/2009
EM	001143226-0002	A1	8/2009

OTHER PUBLICATIONS

U.S. Appl. No. 29/307,345 Applicant: Sheldon, Brent.

DESCRIPTION

FIG. 1 is a front perspective view of a first embodiment of the eyewear, showing a new design;
FIG. 2 is a front view thereof;
FIG. 3 is a left side view thereof;
FIG. 4 is a right side view thereof;
FIG. 5 is a top view thereof;
FIG. 6 is a bottom view thereof;
FIG. 7 is a rear view thereof;
FIG. 8 is a front perspective view of a second embodiment of the eyewear, showing a new design;
FIG. 9 is a front view thereof;
FIG. 10 is a left side view thereof;
FIG. 11 is a right side view thereof;
FIG. 12 is a top view thereof; and,
FIG. 13 is a bottom view thereof.

1 Claim, 11 Drawing Sheets

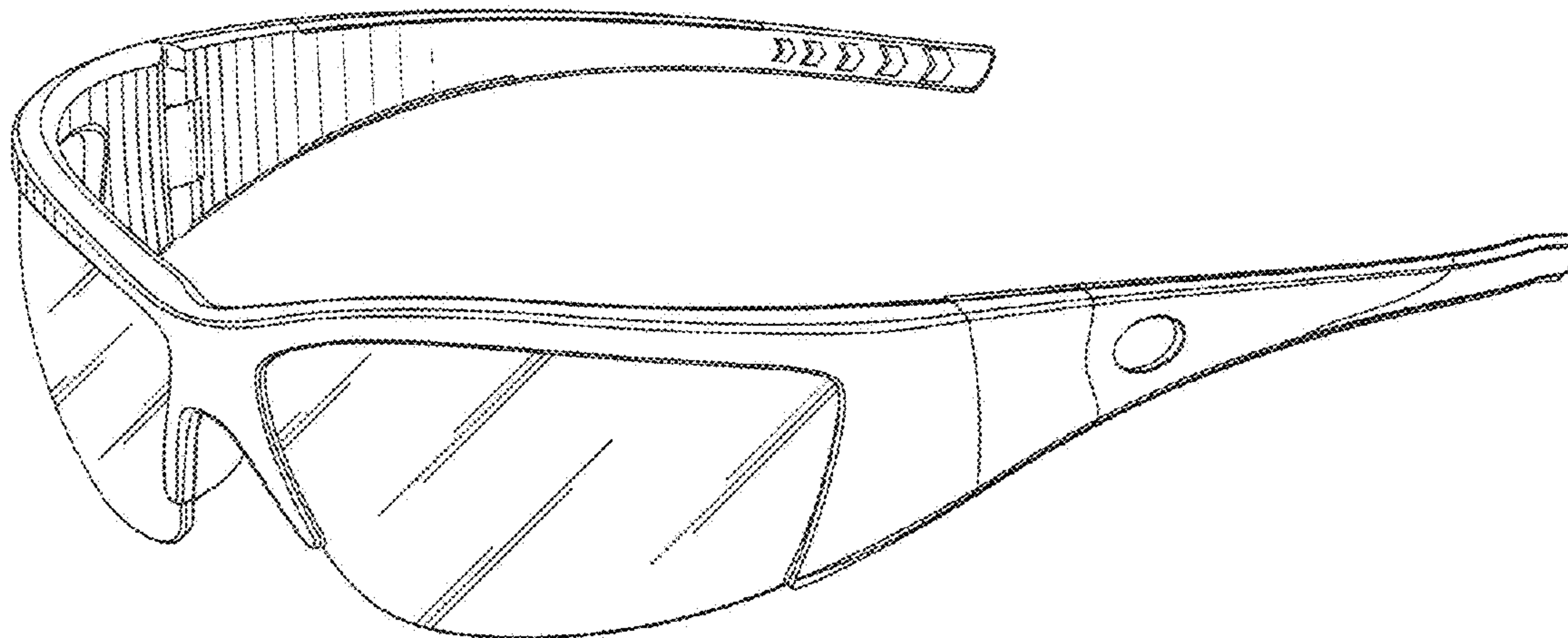

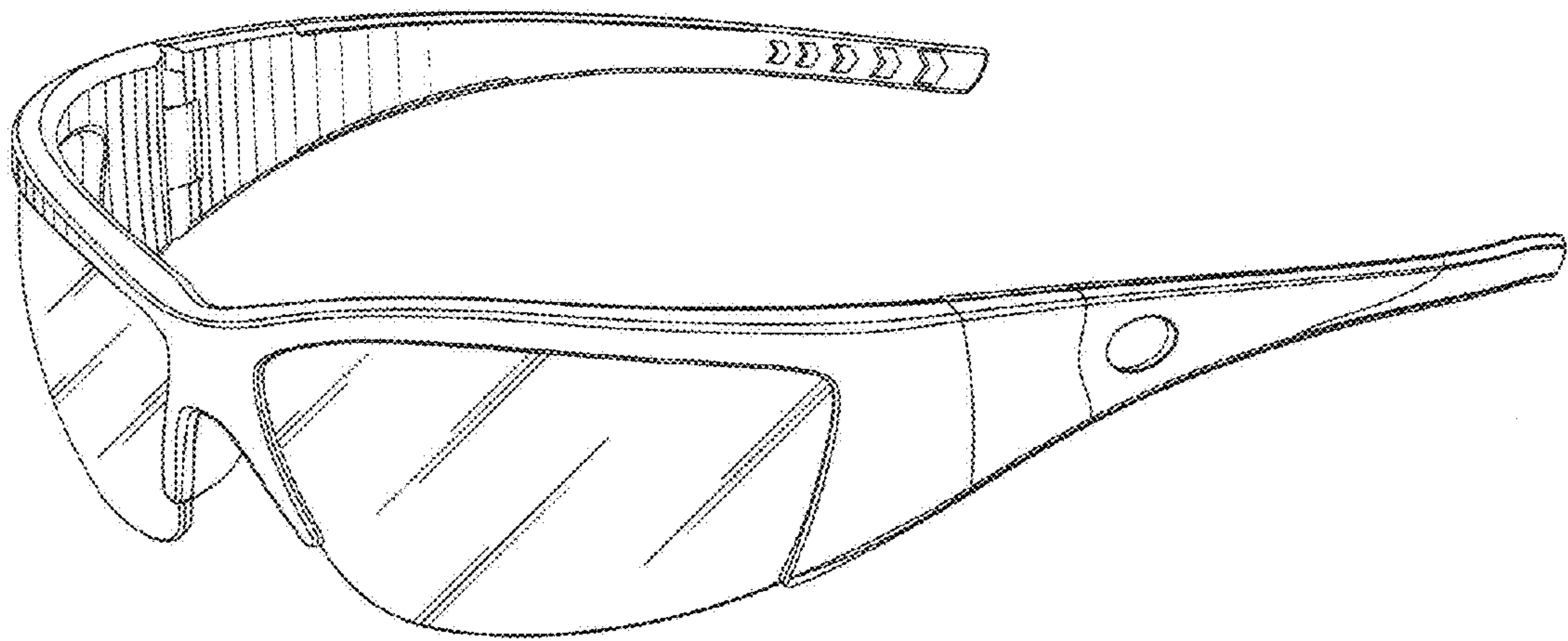

FIG-1

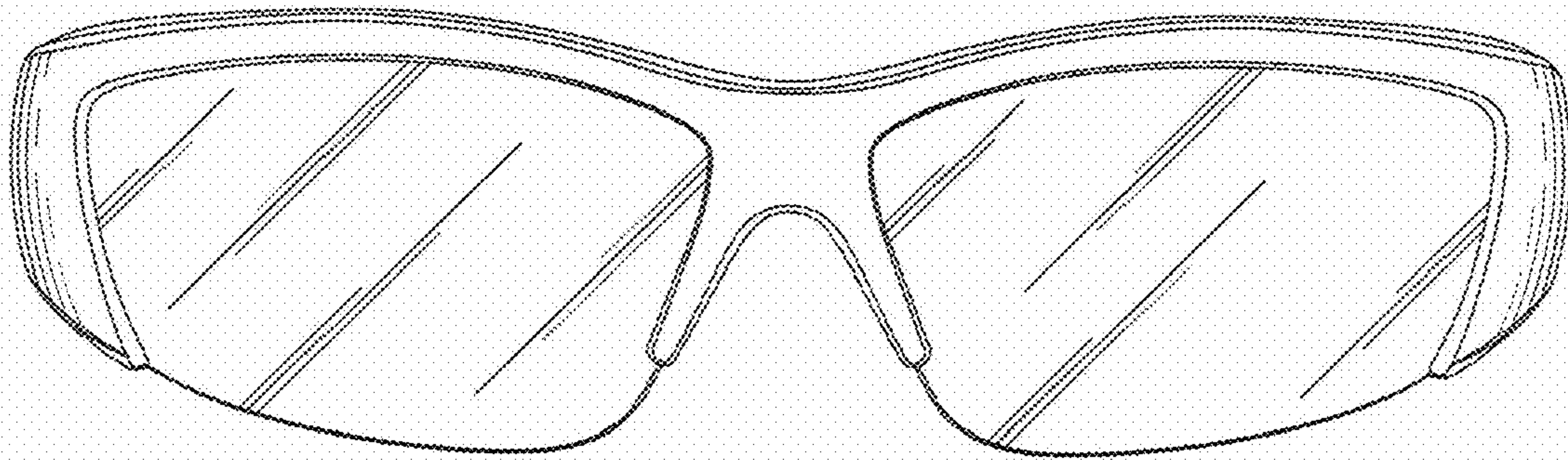

FIG. 2

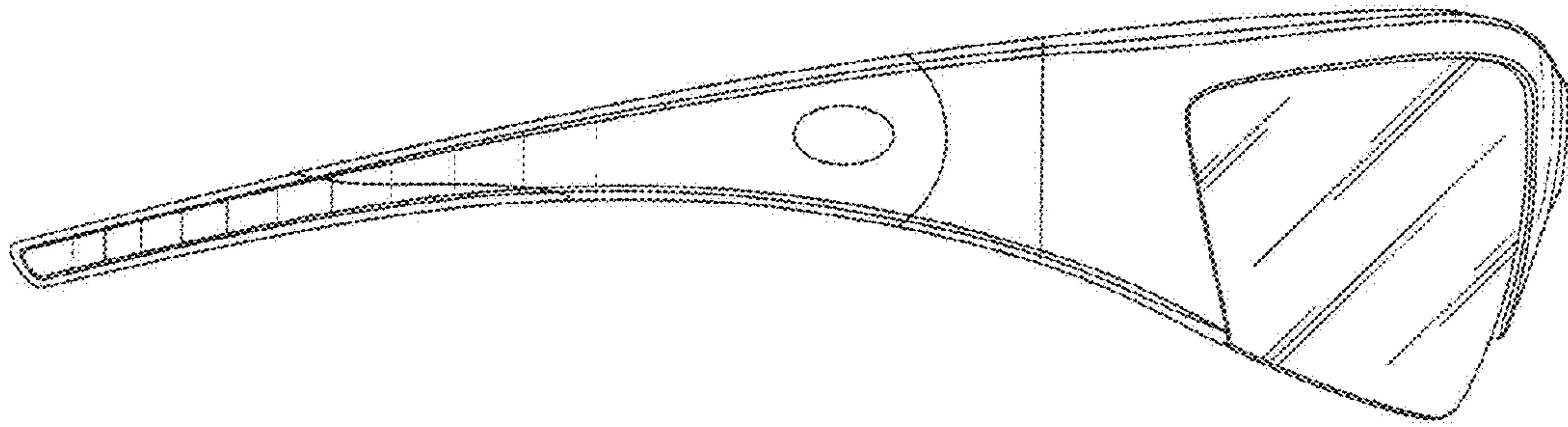

FIG-3

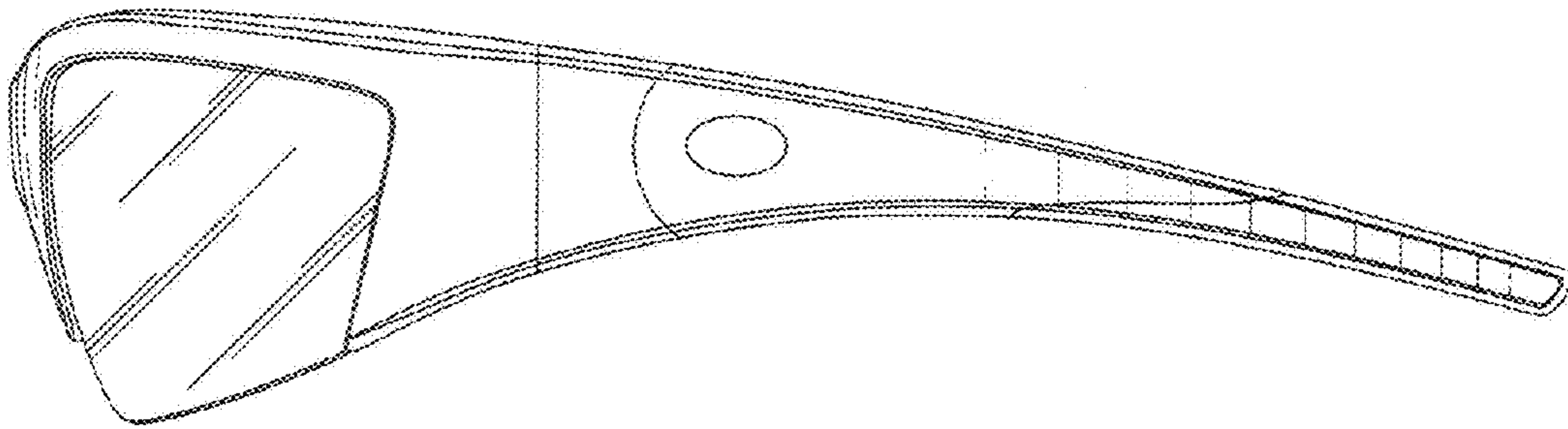

FIG-4

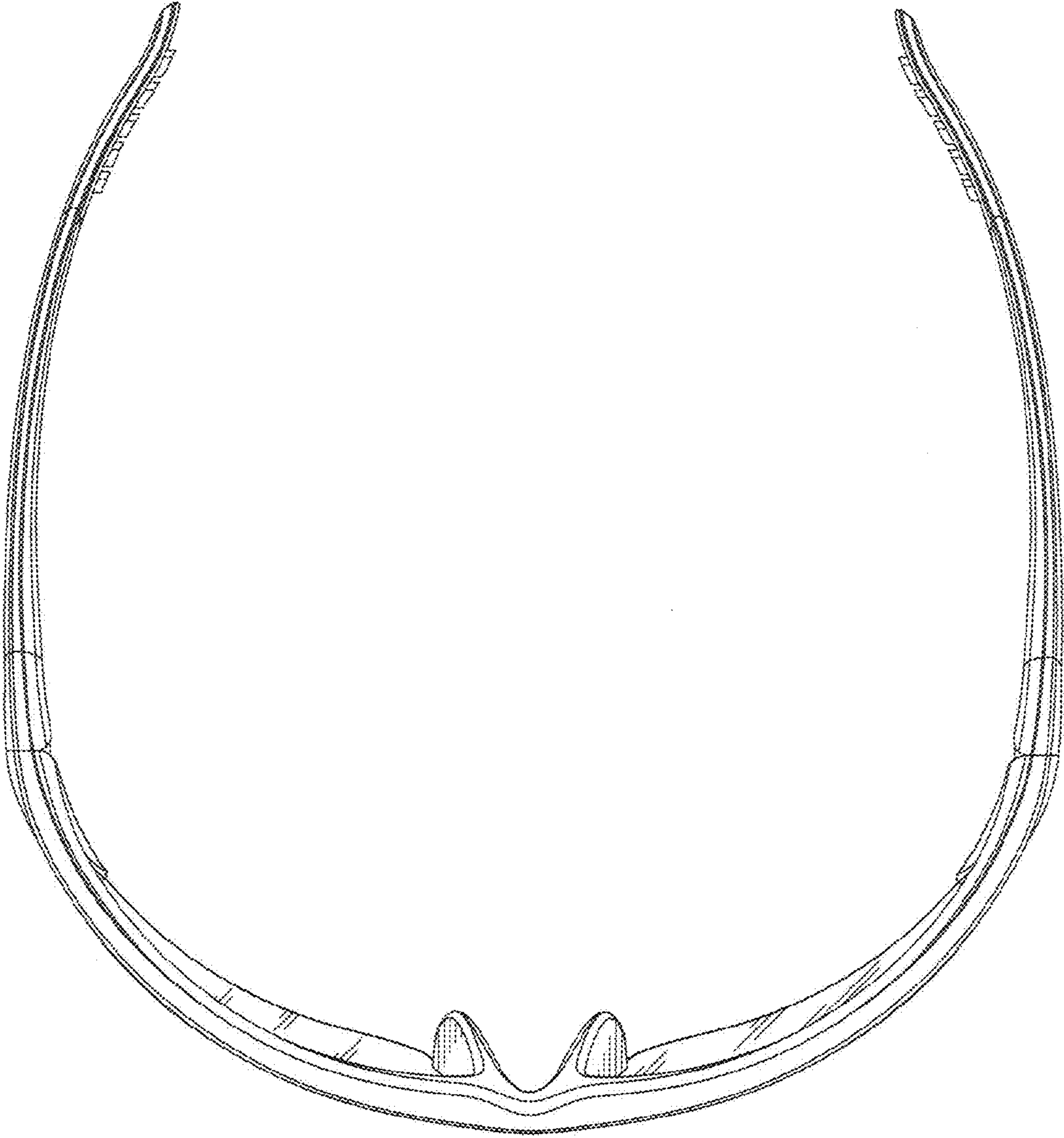

FIG. 5

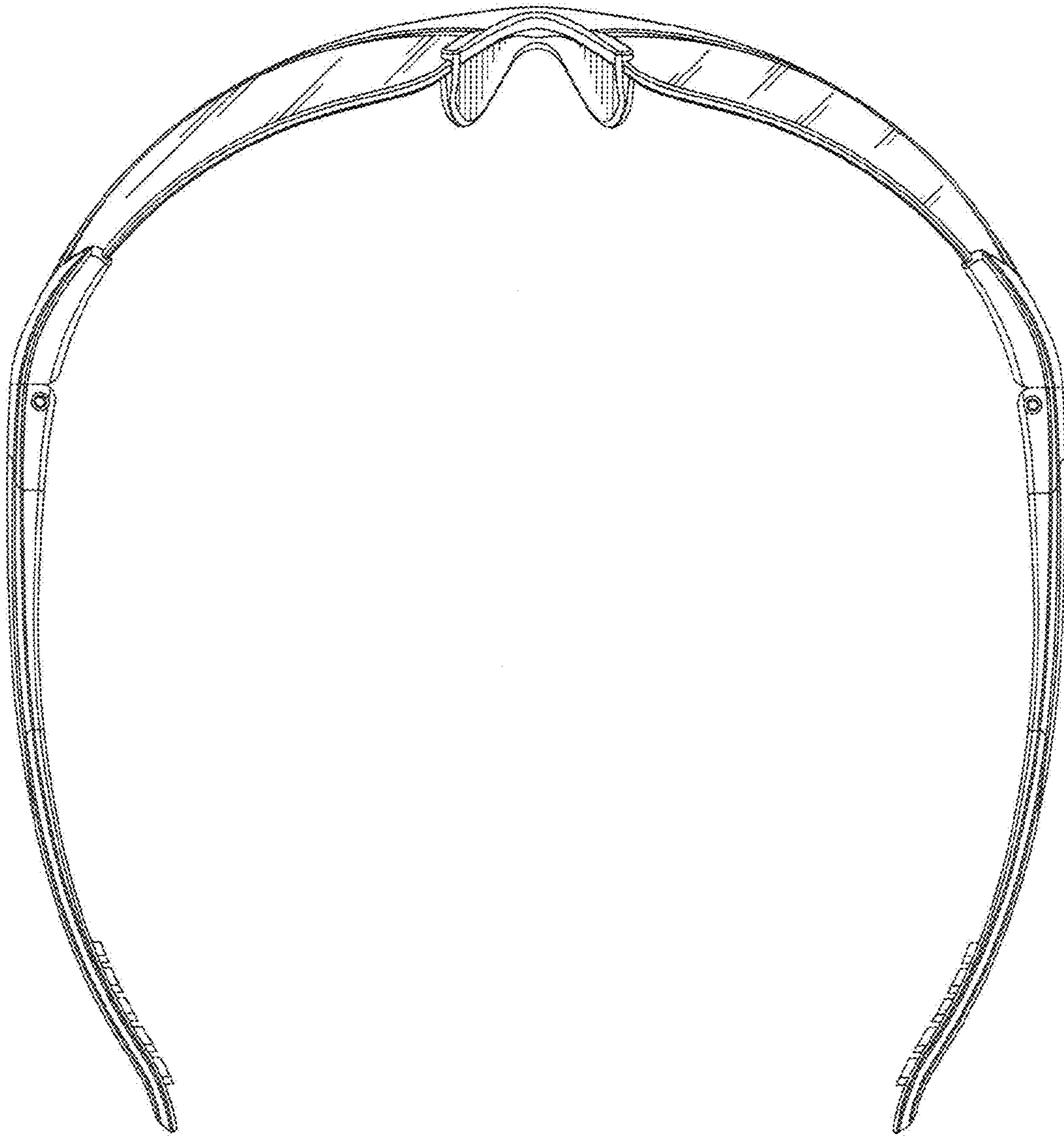

FIG. 6

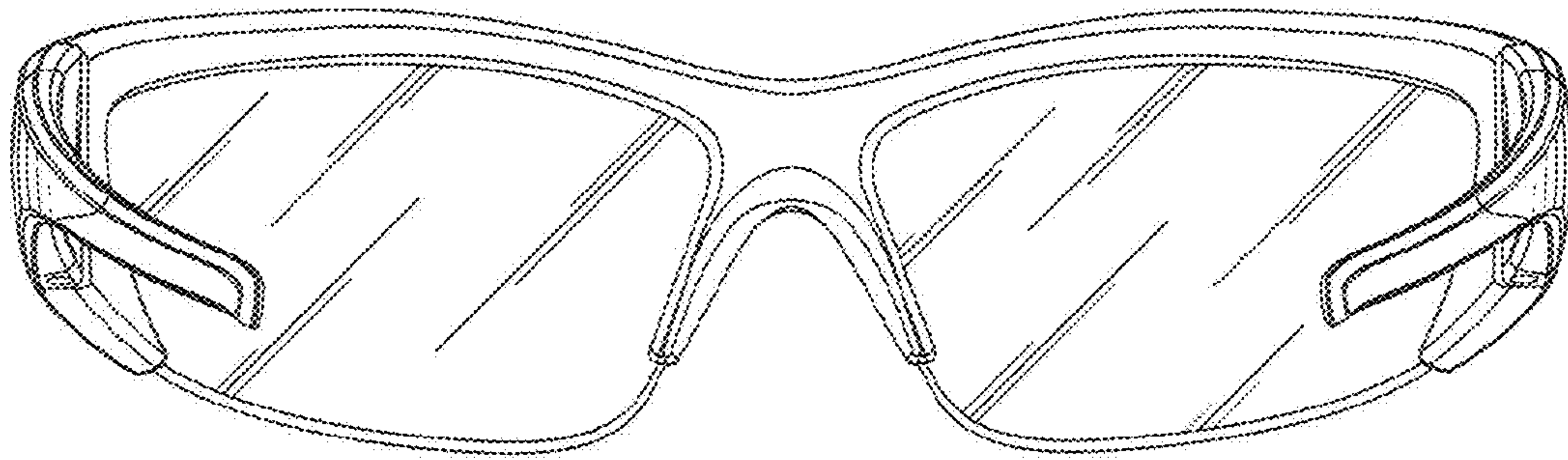

FIG. 7

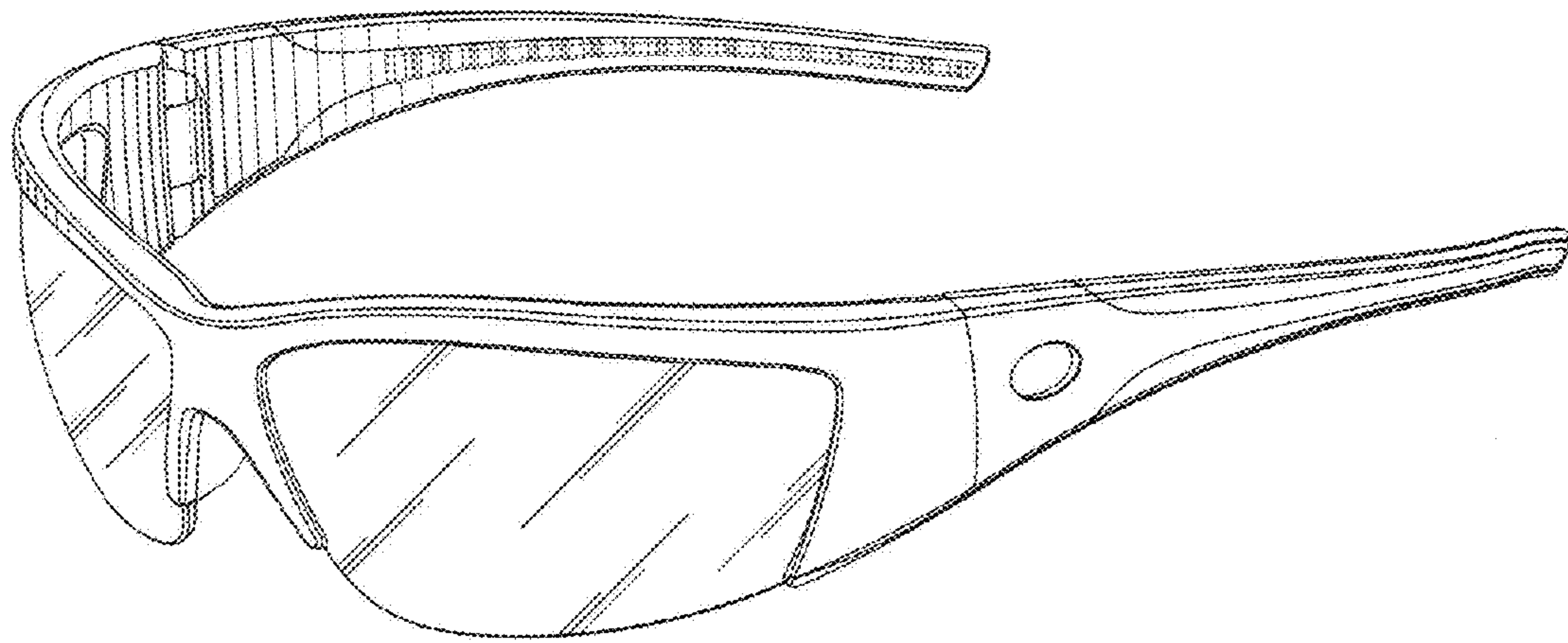

FIG. 8

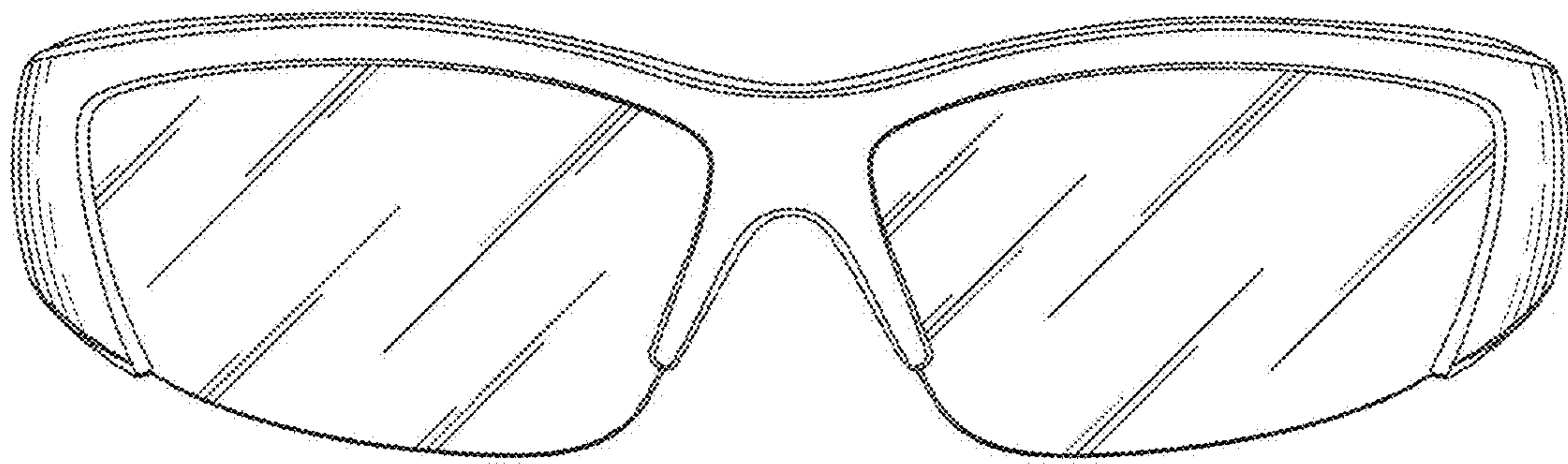

FIG. 9

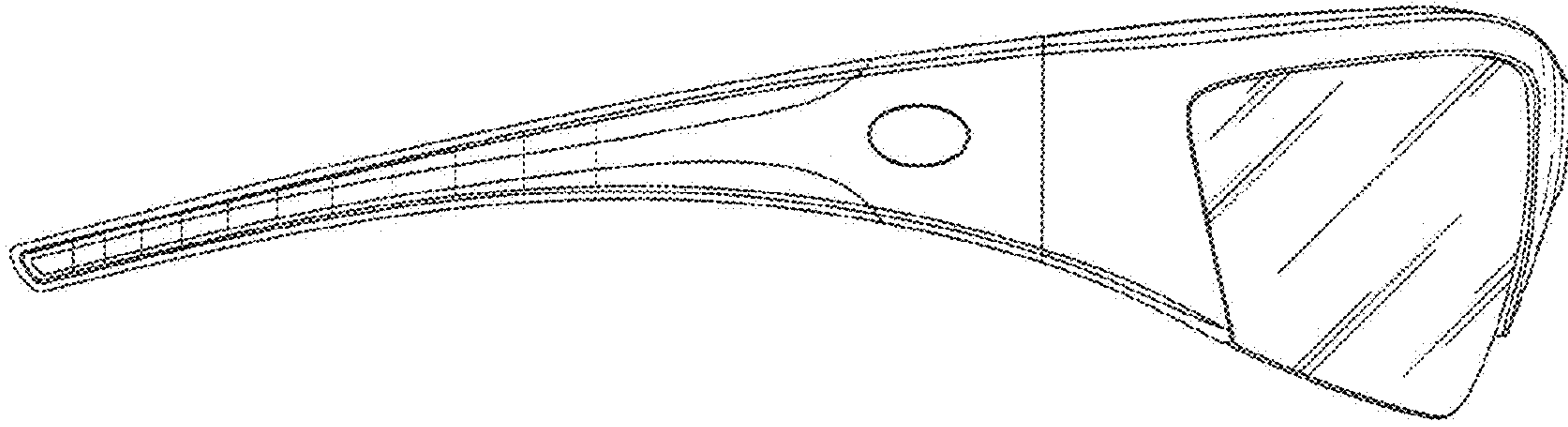

FIG. 10

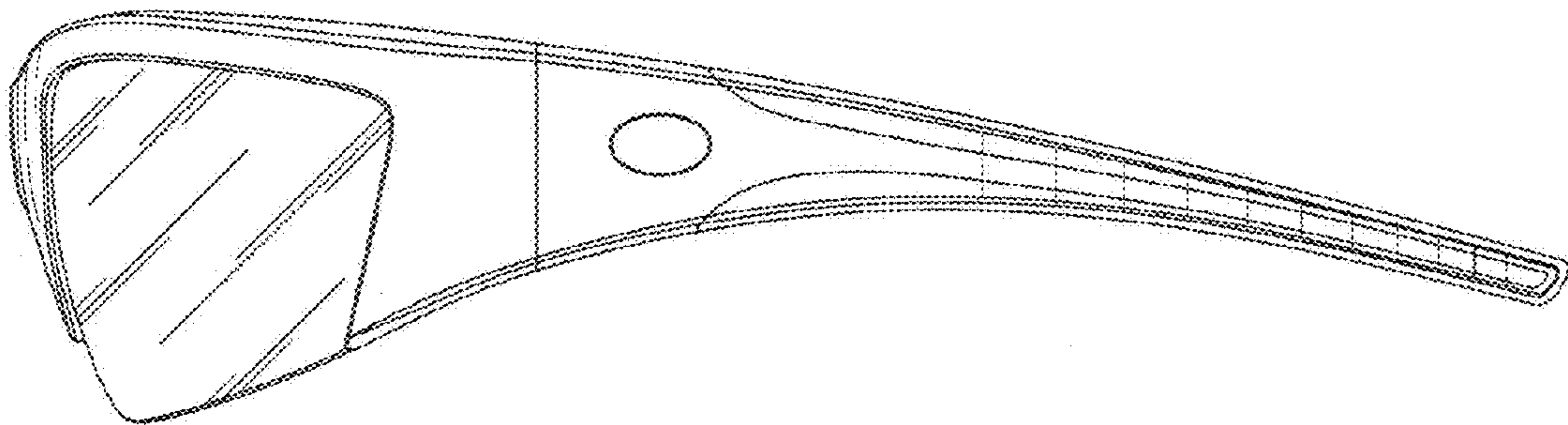

FIG. 11

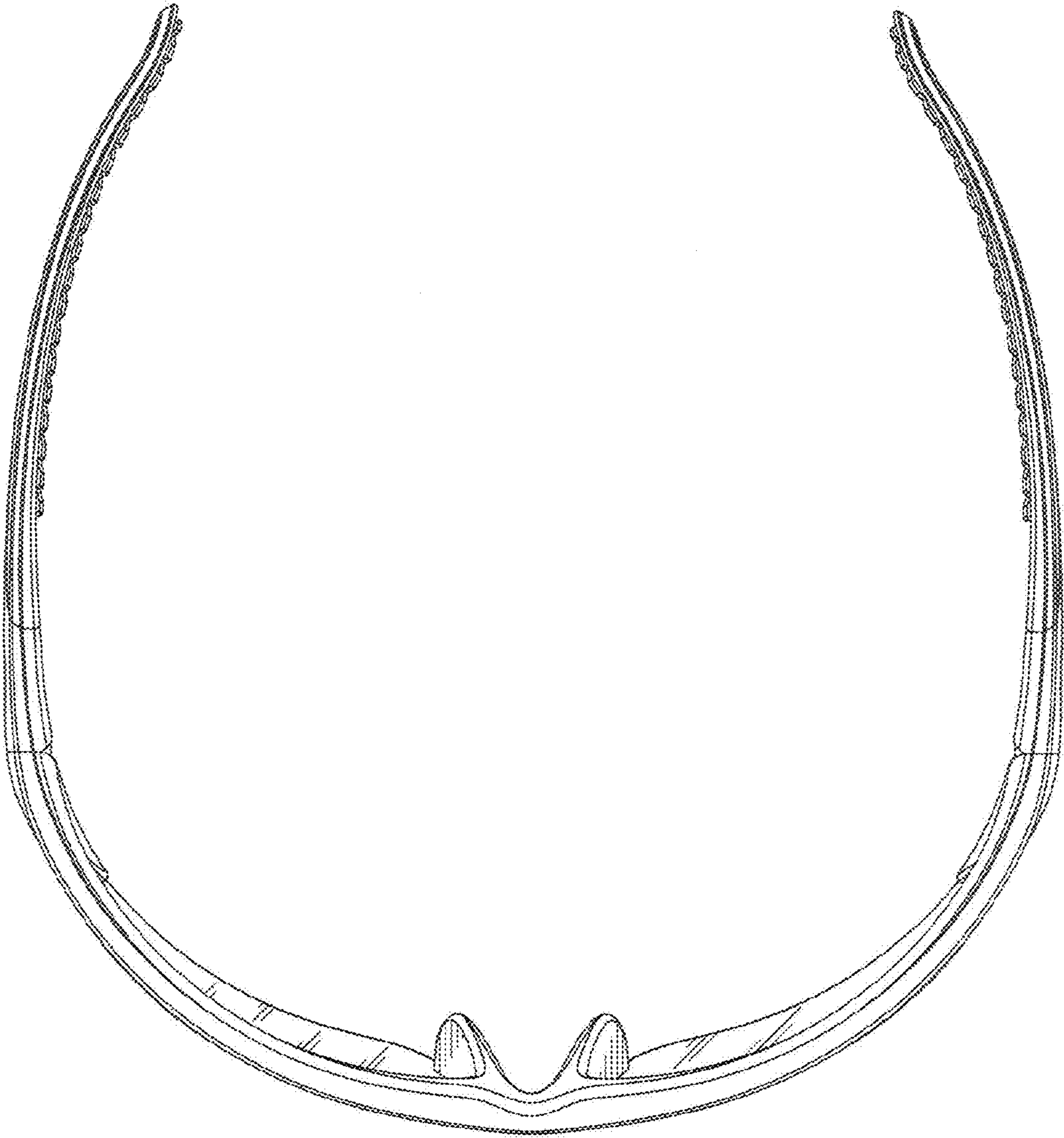

FIG-12

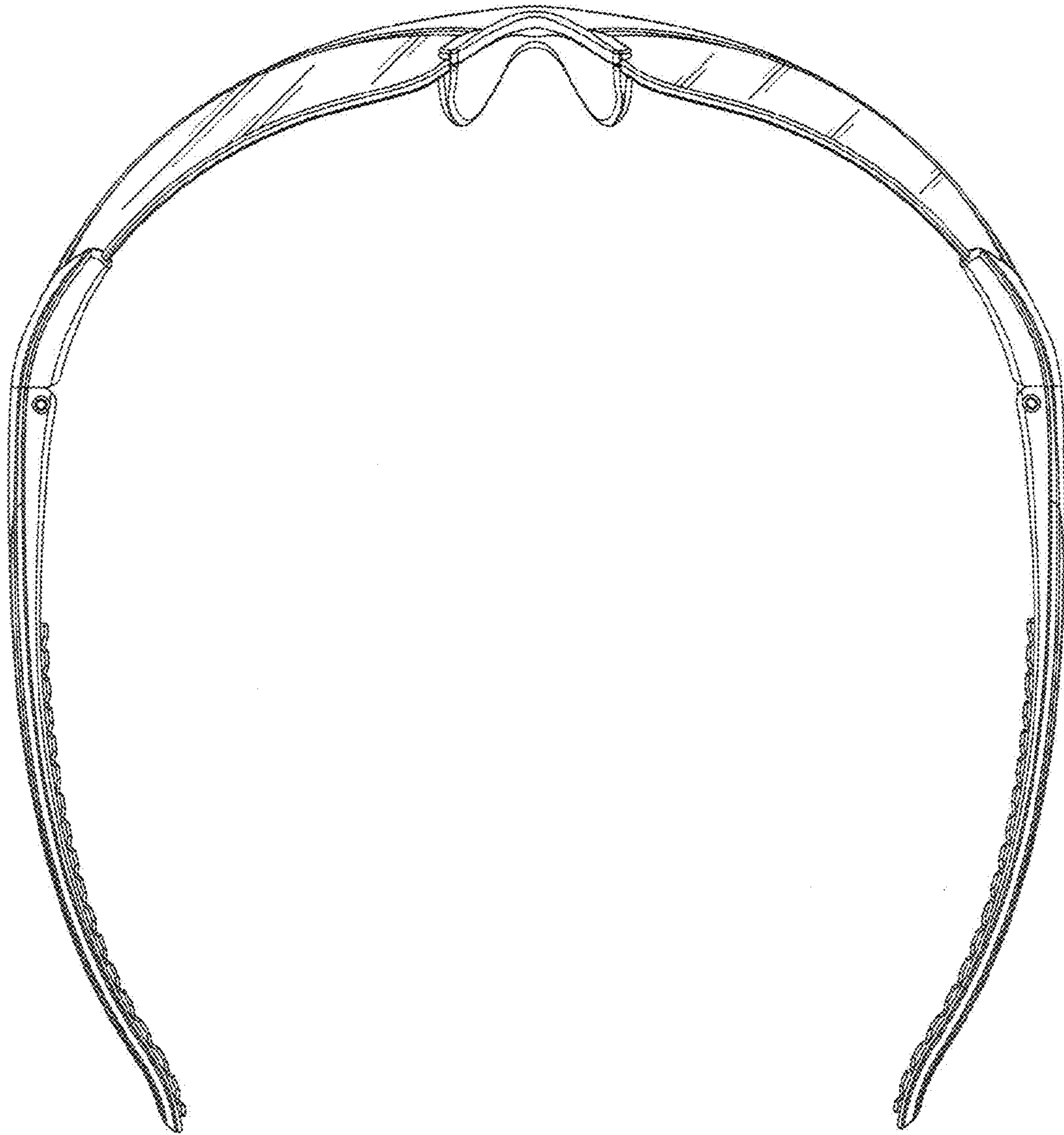

FIG. 13