



US00D638841S

(12) **United States Design Patent**
Musick, Jr. et al.

(10) **Patent No.:** **US D638,841 S**

(45) **Date of Patent:** **** May 31, 2011**

(54) **GAME CONTROLLER**

(75) Inventors: **Charles Musick, Jr.**, Belmont, CA (US);
Robert Kay, San Francisco, CA (US);
Dana Wilkinson, Mountain View, CA (US)

(73) Assignee: **AiLive Inc.**, Mountain View, CA (US)

(**) Term: **14 Years**

(21) Appl. No.: **29/375,201**

(22) Filed: **Sep. 18, 2010**

(51) **LOC (9) Cl.** **14-02**

(52) **U.S. Cl.** **D14/412; D21/333**

(58) **Field of Classification Search** D14/440,
D14/401, 412-416, 388, 399, 218, 217, 496;
D21/324, 333, 332; 273/148 B; 463/1, 30,
463/36-38, 46, 47; 345/156-161, 903
See application file for complete search history.

(56) **References Cited**

U.S. PATENT DOCUMENTS

4,650,934	A *	3/1987	Burke	200/5 R
5,332,322	A *	7/1994	Gambaro	400/489
5,512,892	A *	4/1996	Corballis et al.	341/22
6,338,485	B1 *	1/2002	Huettlinger	273/148 B
6,518,952	B1 *	2/2003	Leiper	345/156

6,809,722	B2 *	10/2004	Mei et al.	345/163
D550,673	S *	9/2007	Wong	D14/413
D556,760	S *	12/2007	Ashida et al.	D14/412
D576,624	S *	9/2008	Ashida et al.	D14/400
D587,713	S *	3/2009	Sutton	D14/412
D594,066	S *	6/2009	Oikawa et al.	D21/333
D622,724	S *	8/2010	Burke et al.	D14/400

* cited by examiner

Primary Examiner — Prabhakar Deshmukh

(74) *Attorney, Agent, or Firm* — Joe Zheng

(57) **CLAIM**

We claim the ornamental design for a game controller, as shown and described.

DESCRIPTION

FIG. 1 is a perspective view of a game controller incorporating our new design;
FIG. 2 is a left side view thereof;
FIG. 3 is a right side view thereof;
FIG. 4 is a front view thereof;
FIG. 5 is a rear side view thereof;
FIG. 6 is a top view thereof; and,
FIG. 7 is a bottom side view thereof.
The broken lines illustrating disclaimed portions and form no part of the claimed design.

1 Claim, 4 Drawing Sheets

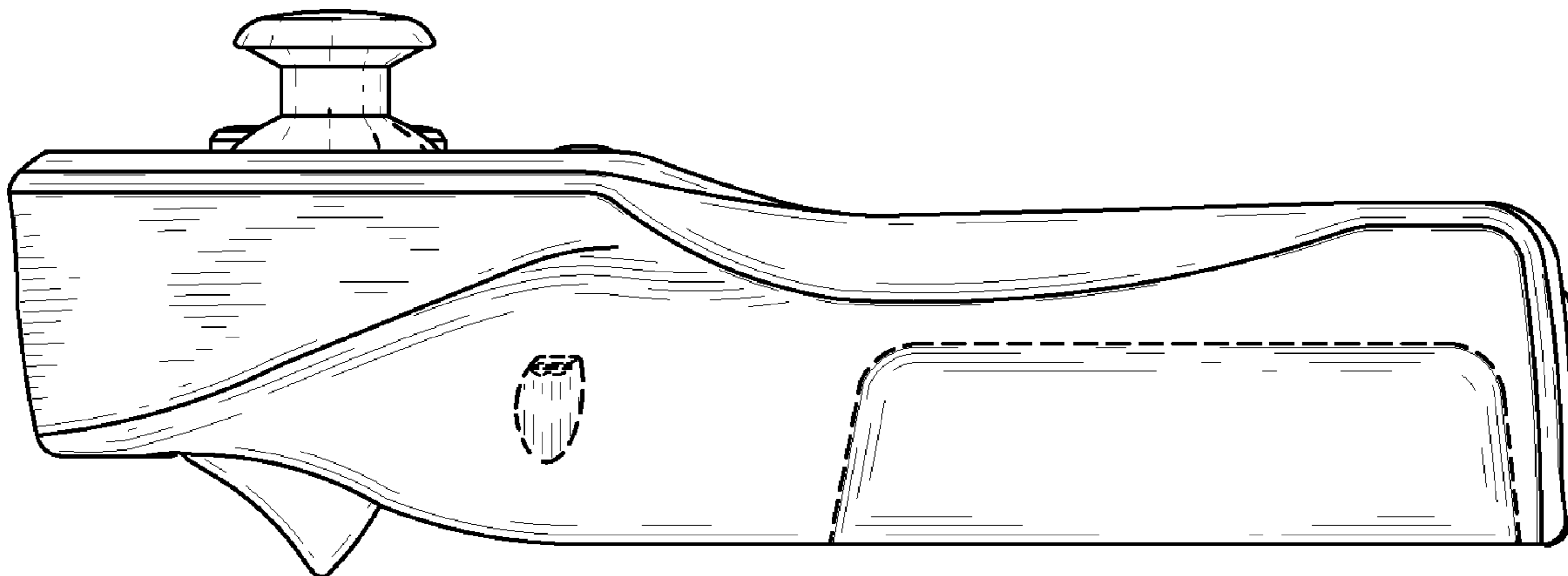

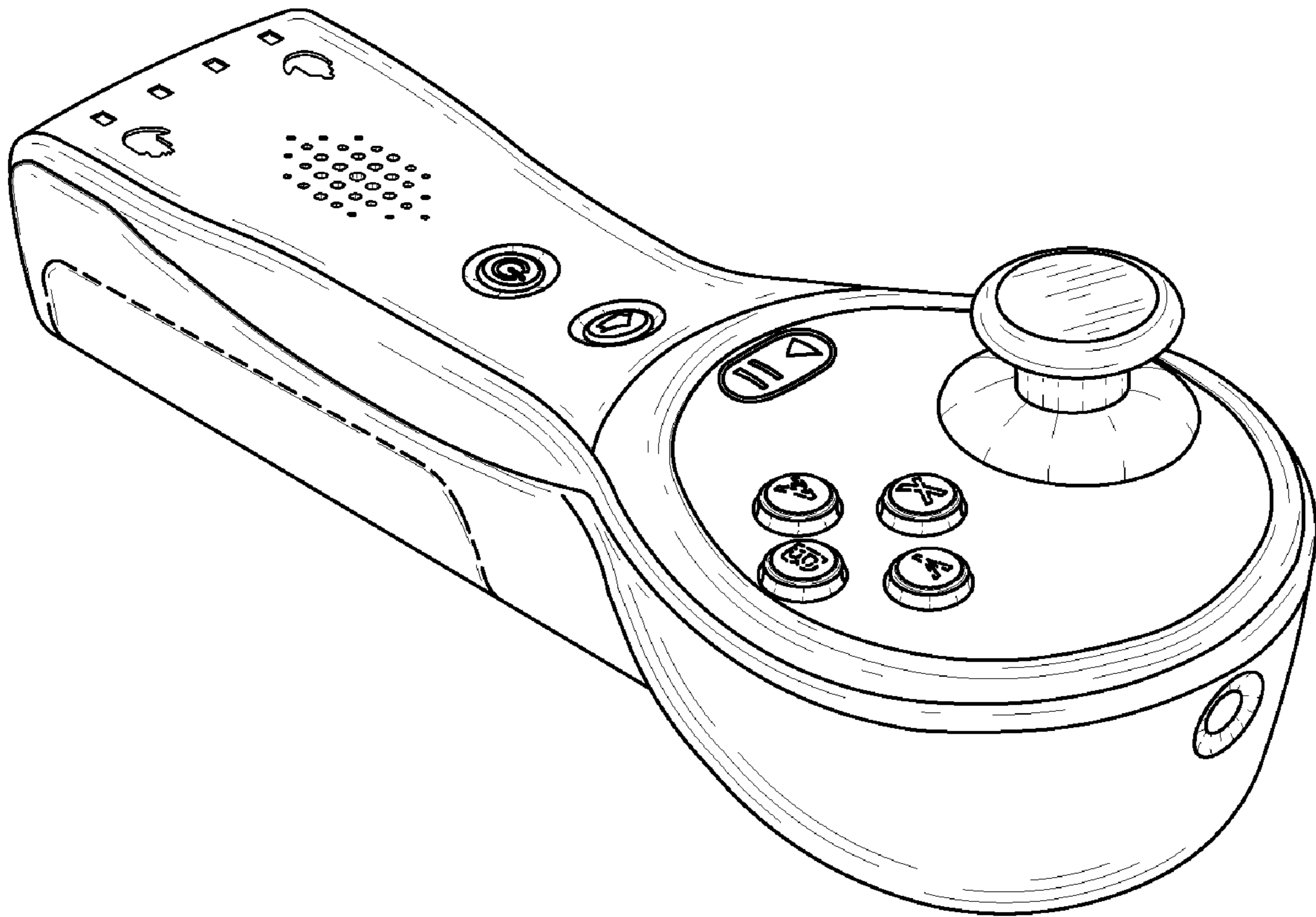

FIG. 1

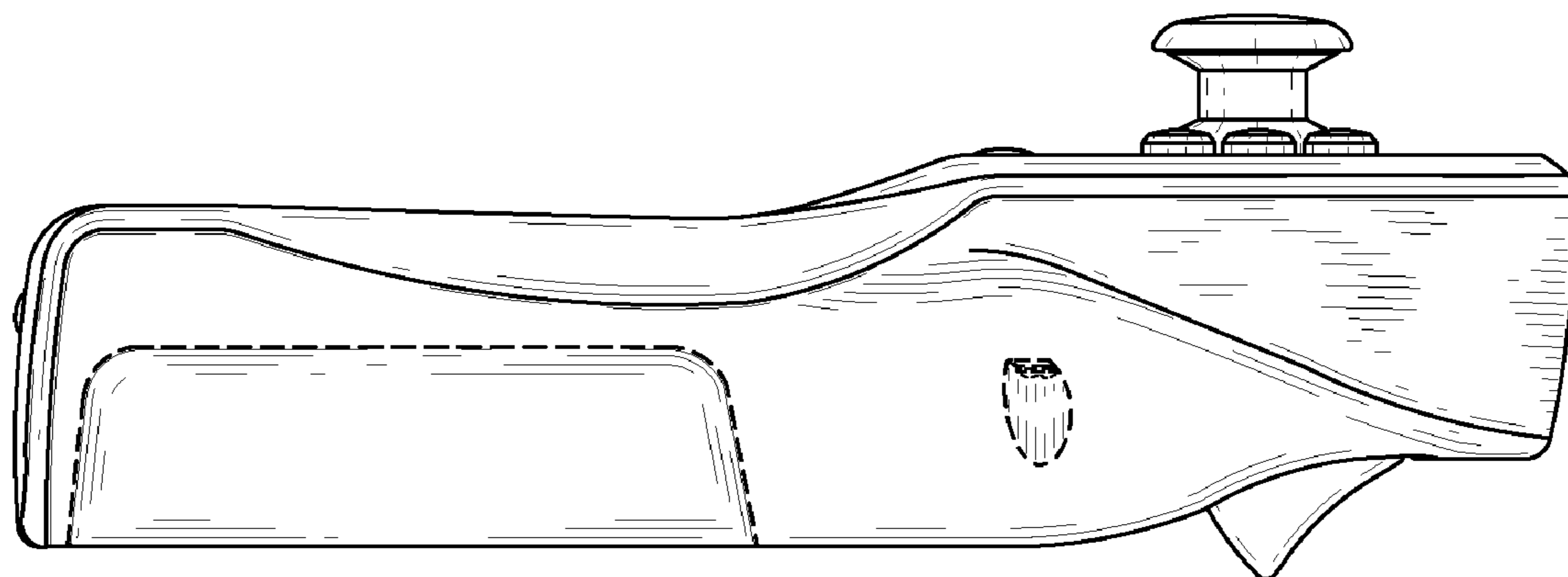

FIG. 2

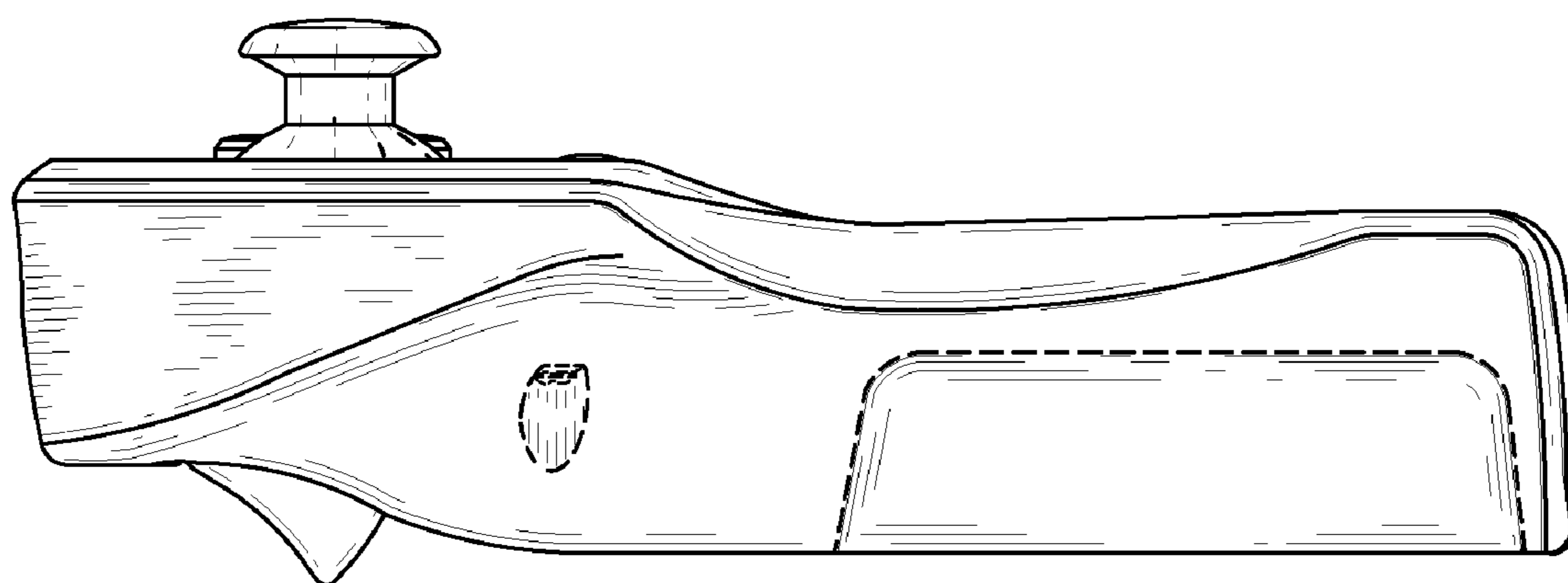

FIG. 3

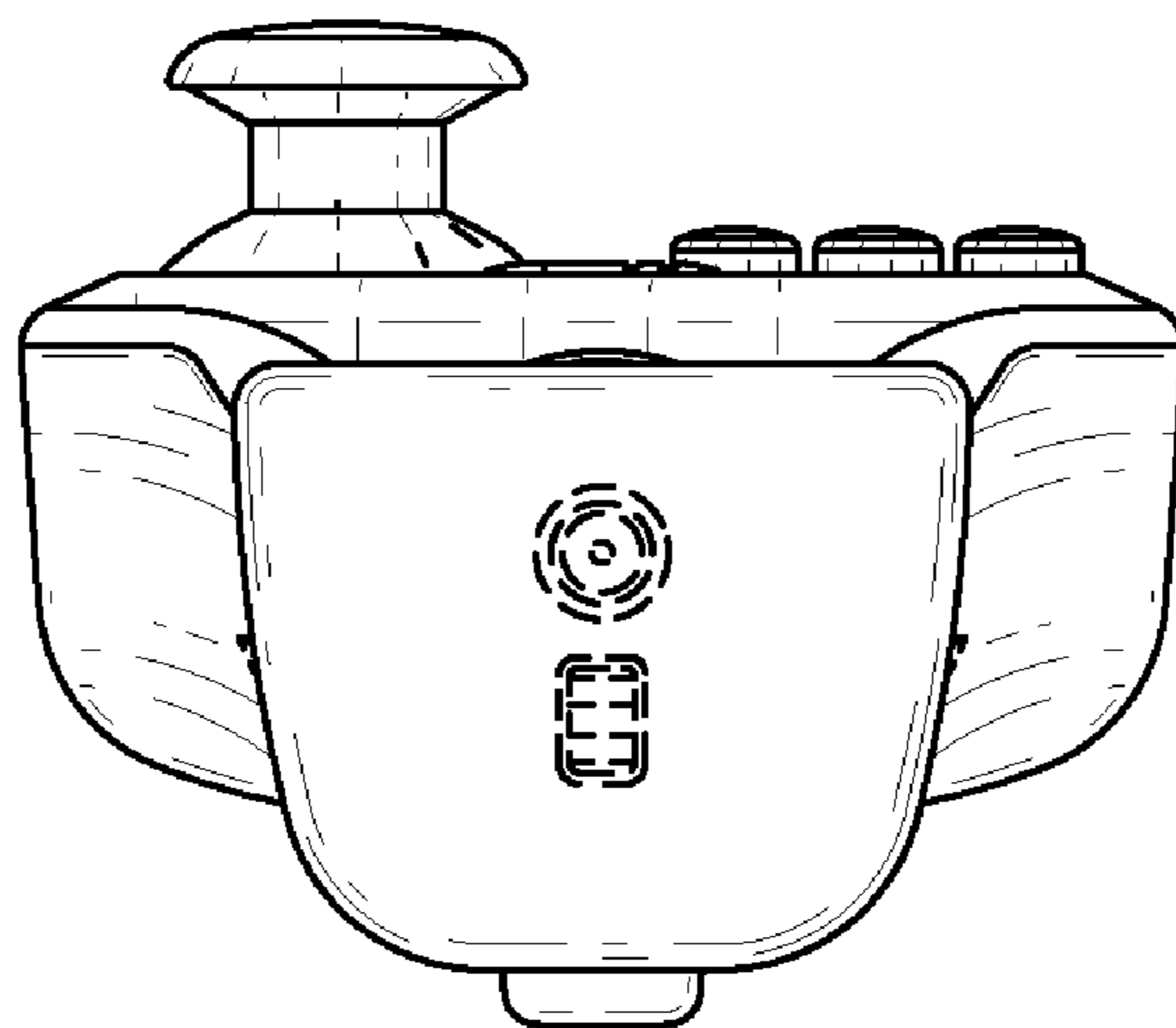

FIG. 4

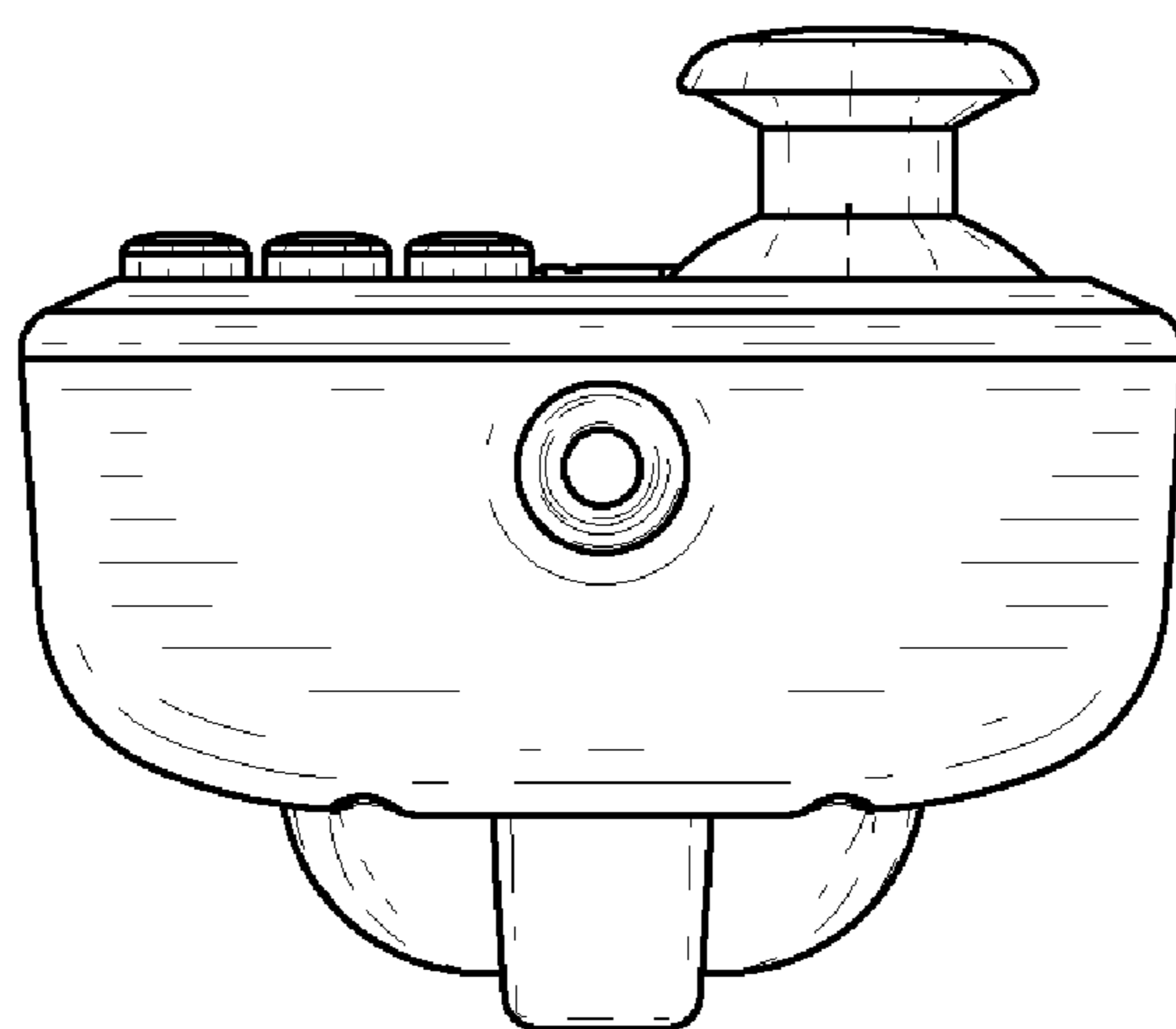

FIG. 5

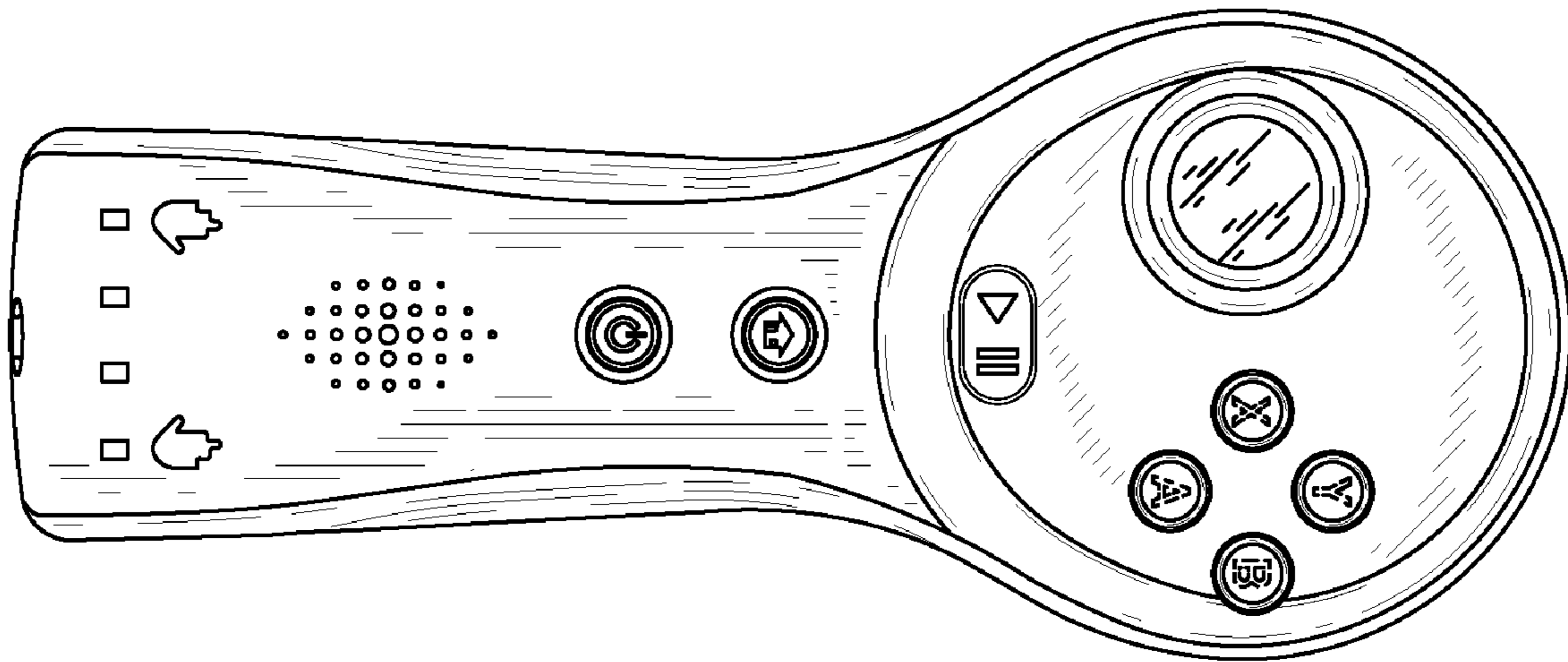

FIG. 6

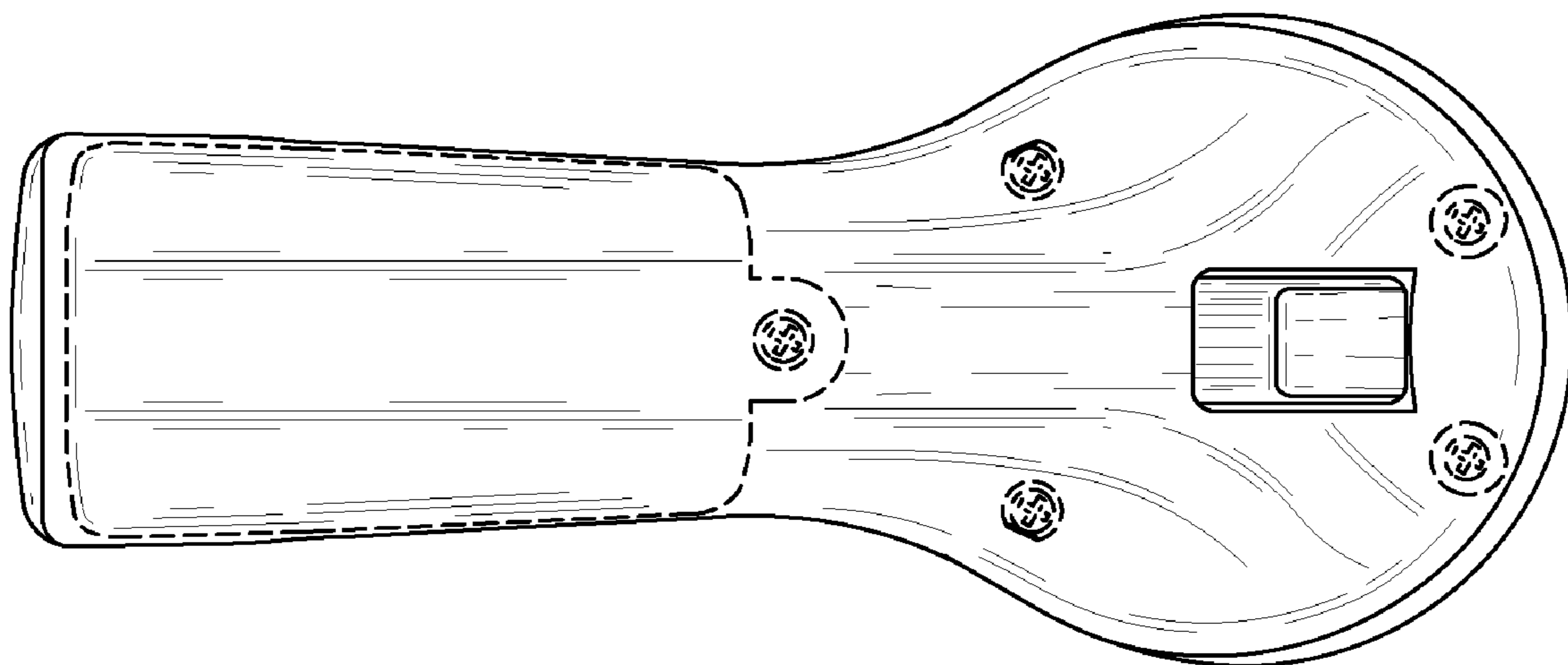

FIG. 7