



US00D638787S

(12) **United States Design Patent**
Tanaka et al.

(10) **Patent No.:** **US D638,787 S**

(45) **Date of Patent:** **** May 31, 2011**

(54) **BATTERY FOR AN ELECTRIC BICYCLE**

(75) Inventors: **Yosuke Tanaka**, Kobe (JP); **Katsuyuki Tomonaga**, Osaka (JP)

(73) Assignees: **Sanyo Electric Co., Ltd.**, Moriguchi-shi (JP); **Sanyo Consumer Electronics Co., Ltd.**, Tottori-shi (JP)

(**) Term: **14 Years**

(21) Appl. No.: **29/364,929**

(22) Filed: **Jun. 30, 2010**

(30) **Foreign Application Priority Data**

Jan. 29, 2010 (JP) 2010-002071

(51) **LOC (9) Cl.** **13-02**

(52) **U.S. Cl.** **D13/103**

(58) **Field of Classification Search** D13/102–106,
D13/110, 118–121, 184, 199; 429/96–100,
429/163, 176, 187

See application file for complete search history.

(56) **References Cited**

U.S. PATENT DOCUMENTS

D334,560 S * 4/1993 Wilson D13/106
D350,544 S * 9/1994 Sakuta et al. D14/240
D363,937 S * 11/1995 Marks et al. D14/253

D393,446 S * 4/1998 Bellofatto et al. D13/106
D546,282 S * 7/2007 Wardenburg D13/110
D555,586 S * 11/2007 McConnell D13/103
D559,175 S * 1/2008 Houghton D13/103
D579,870 S * 11/2008 Dunbar et al. D13/116

* cited by examiner

Primary Examiner — Rosemary K Tarcza

(74) *Attorney, Agent, or Firm* — Westerman, Hattori, Daniels & Adrian, LLP

(57) **CLAIM**

The ornamental design for a battery for an electric bicycle, as shown and described.

DESCRIPTION

FIG. 1 is a left front perspective view of a battery for an electric bicycle showing our new design; FIG. 2 is a left side elevational view thereof; FIG. 3 is a right side elevational view thereof; FIG. 4 is a top plan view thereof; FIG. 5 is a bottom plan view thereof; FIG. 6 is a front elevational view thereof; FIG. 7 is a rear elevational view thereof; and, FIG. 8 is a cross-sectional view thereof taken along line 8—8 of FIG. 2.

The elements in broken lines show environmental structure and form no part of the claimed design.

1 Claim, 7 Drawing Sheets

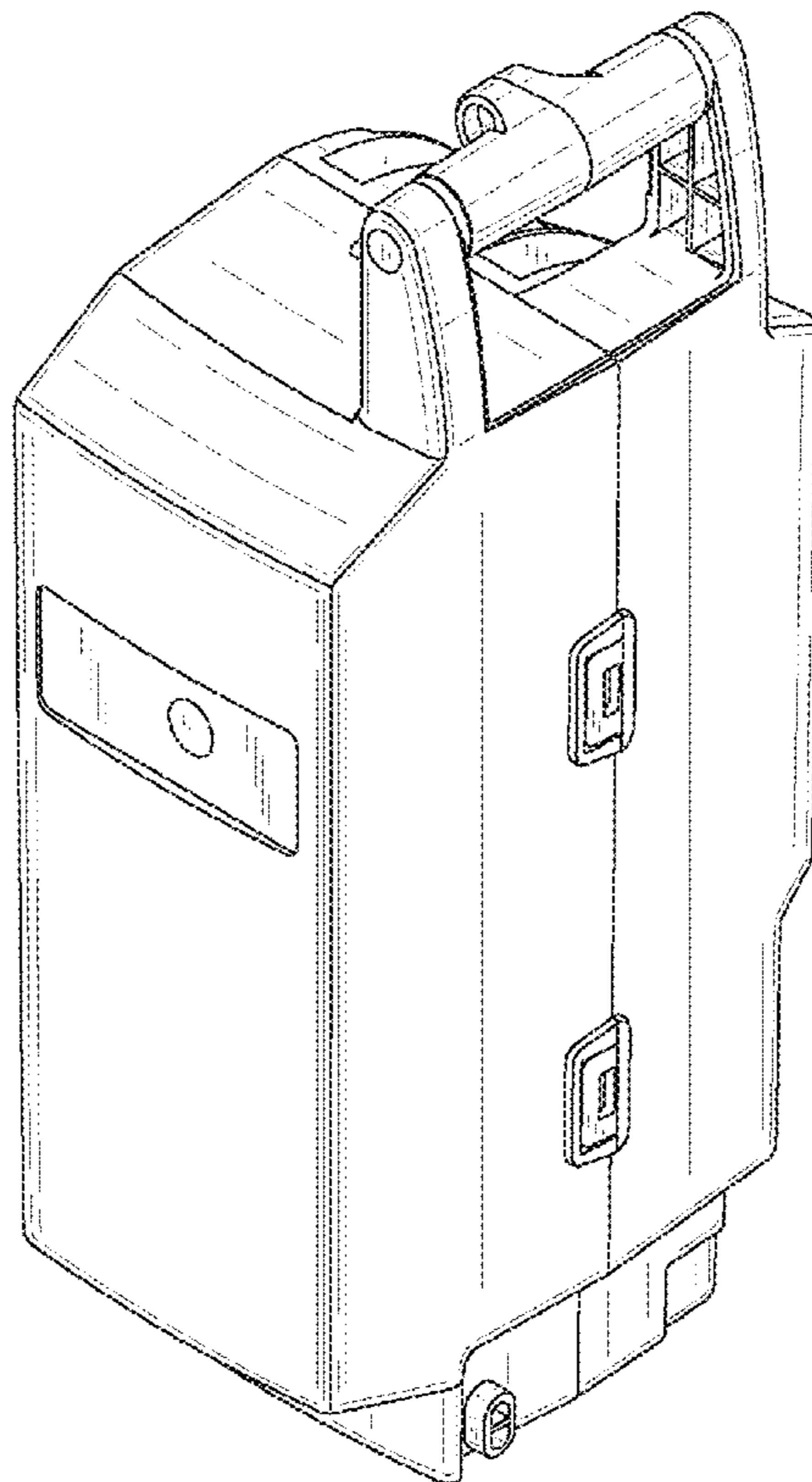

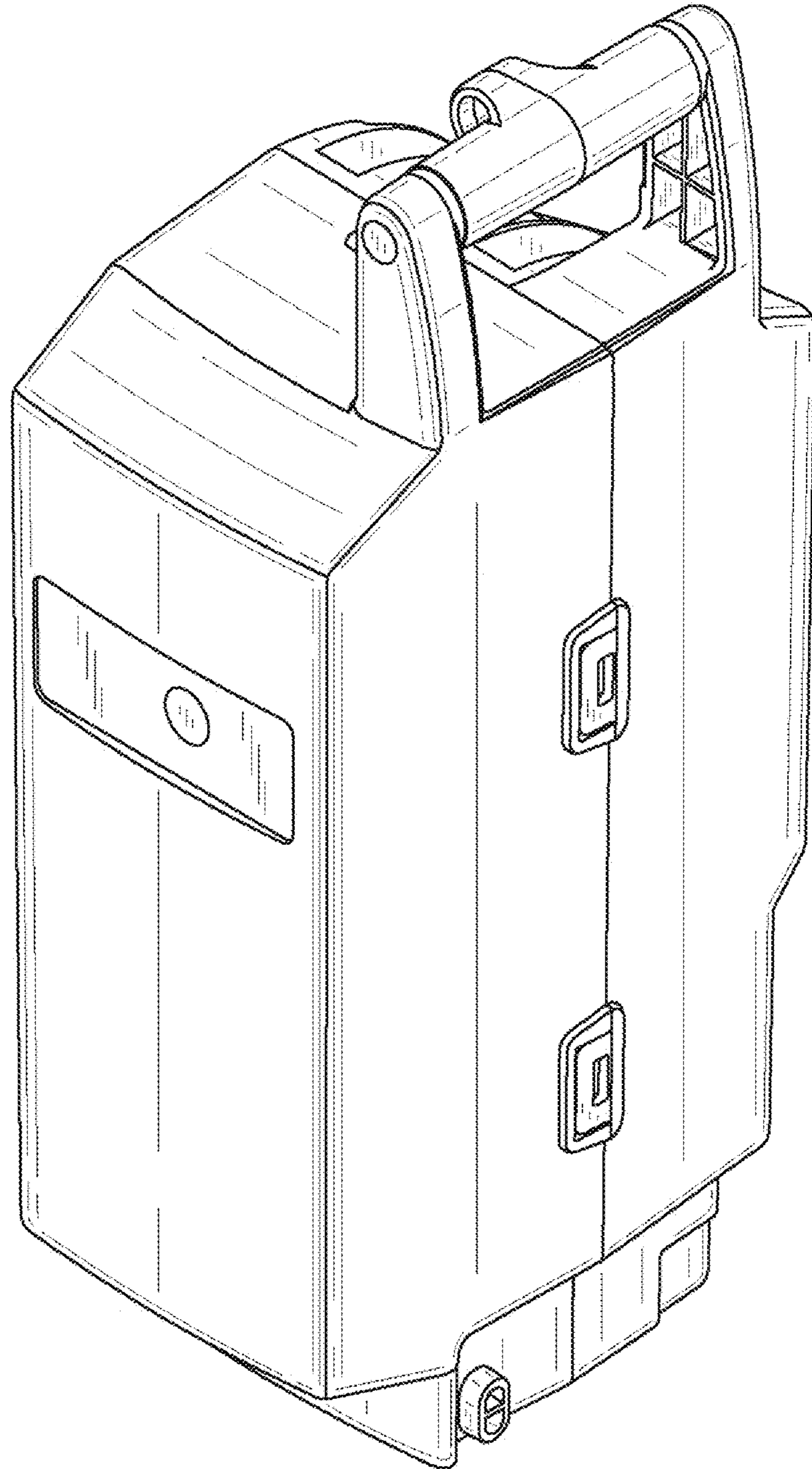

FIG. 1

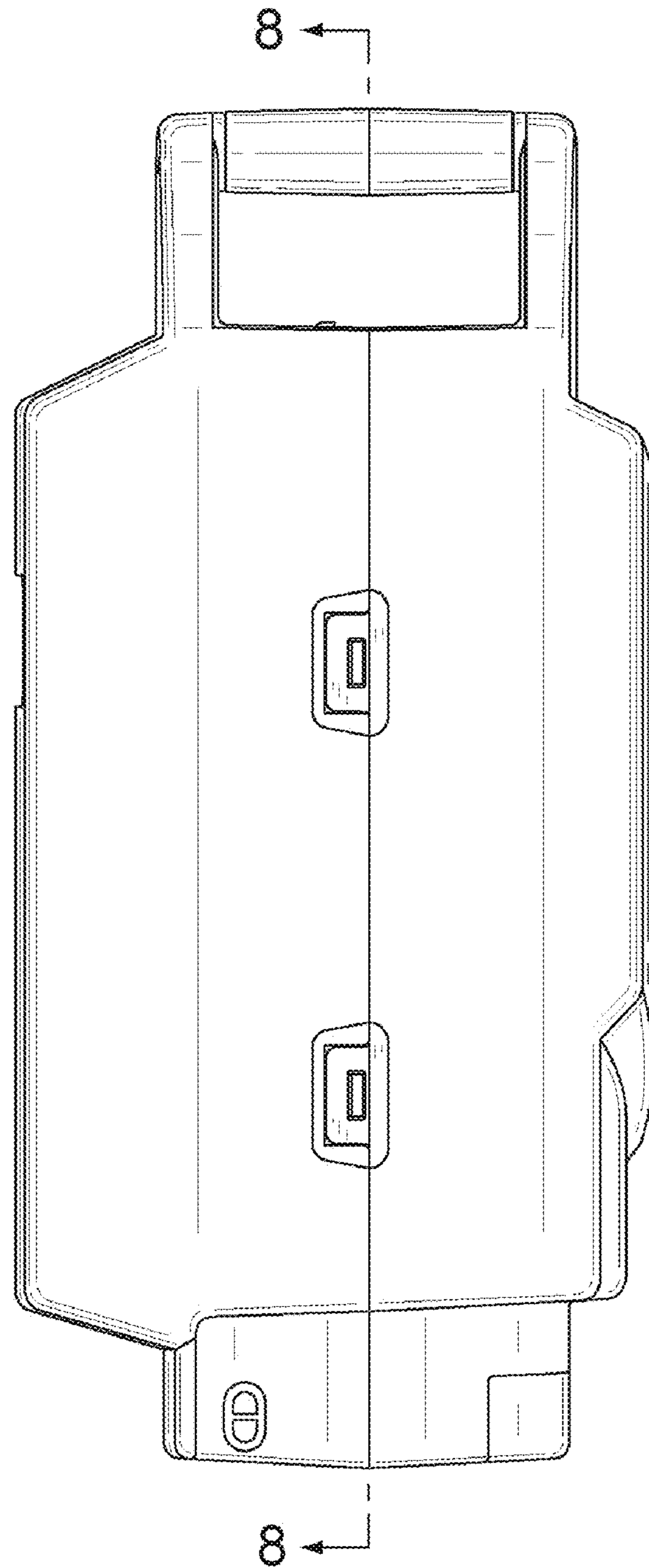

FIG.2

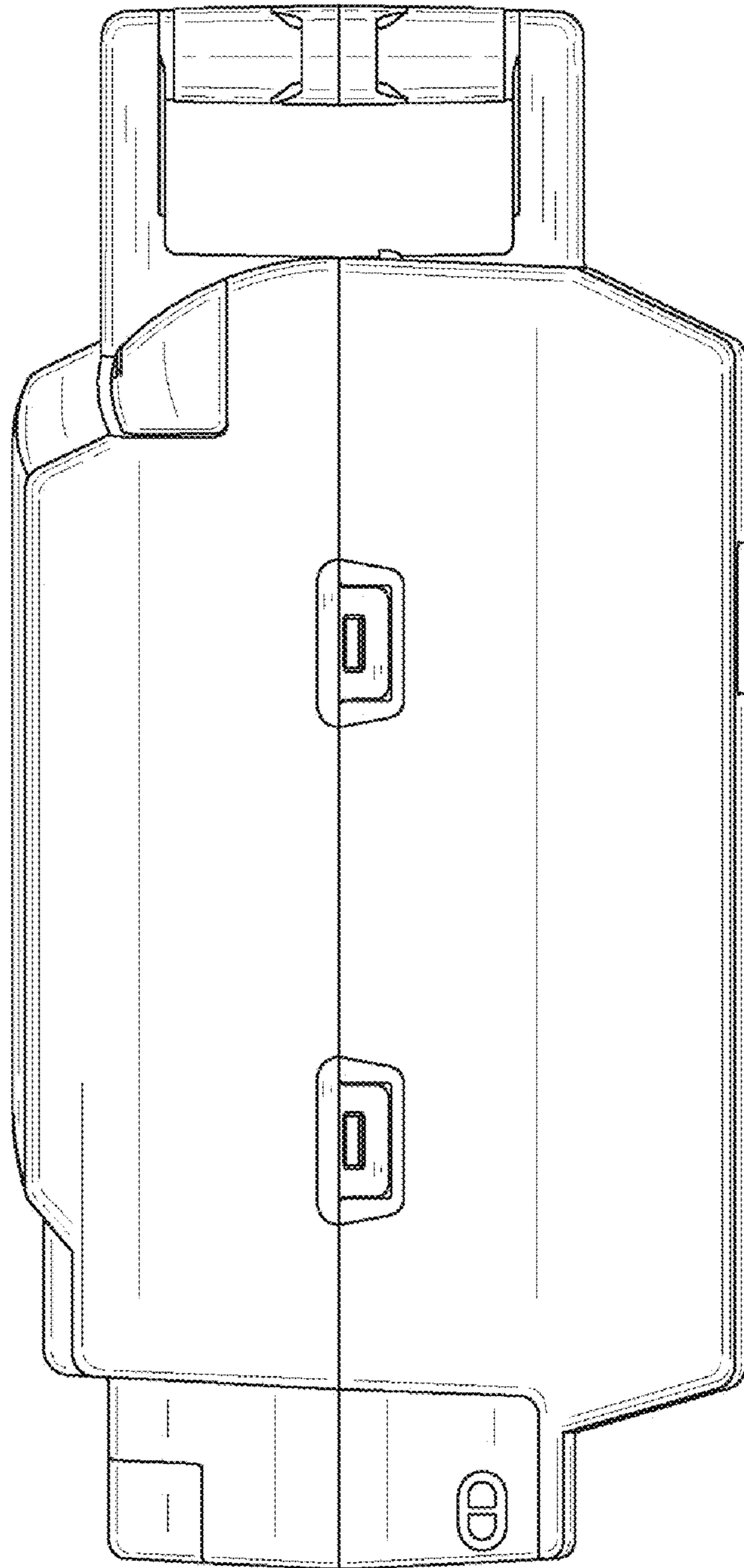

FIG. 3

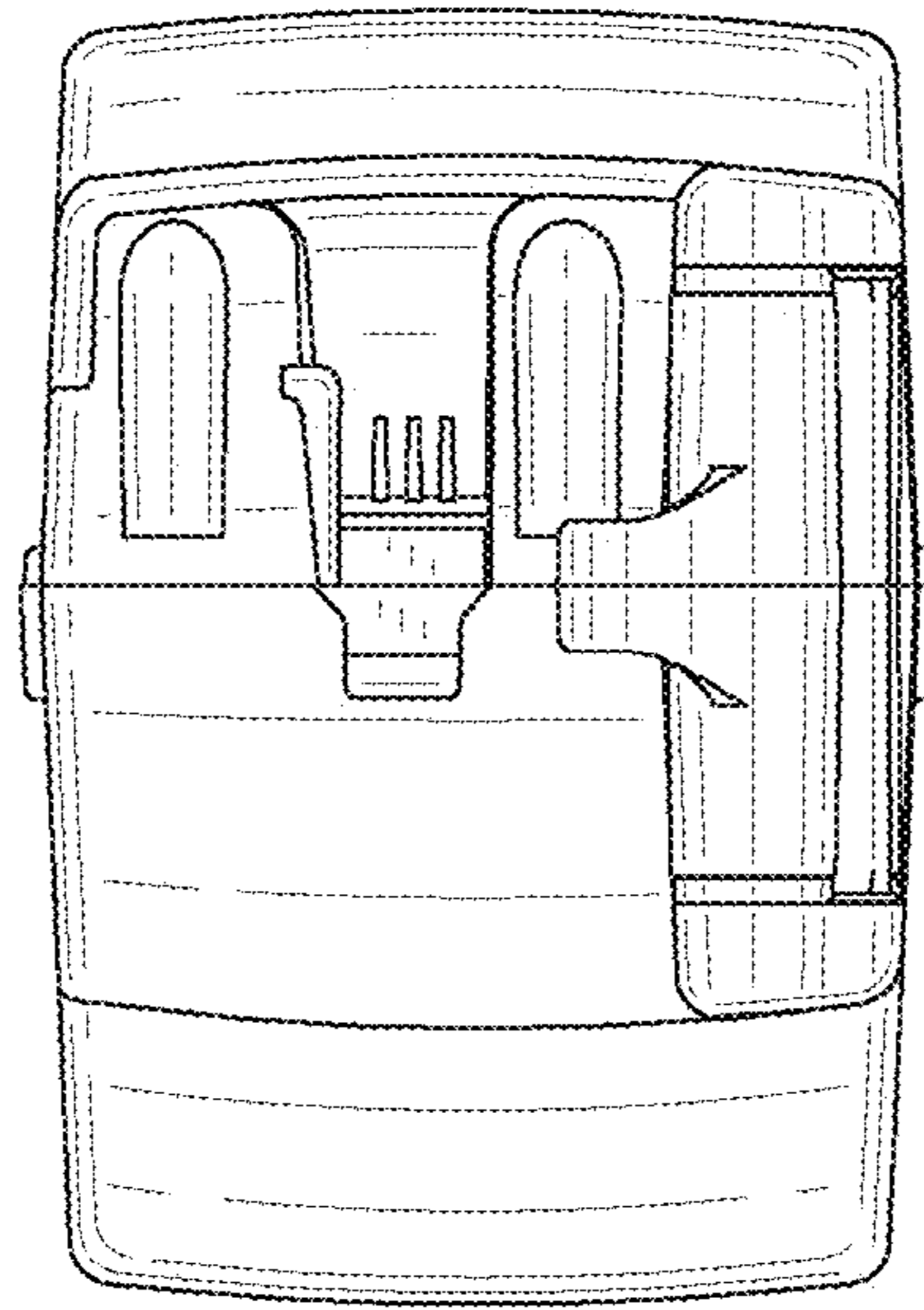

FIG. 4

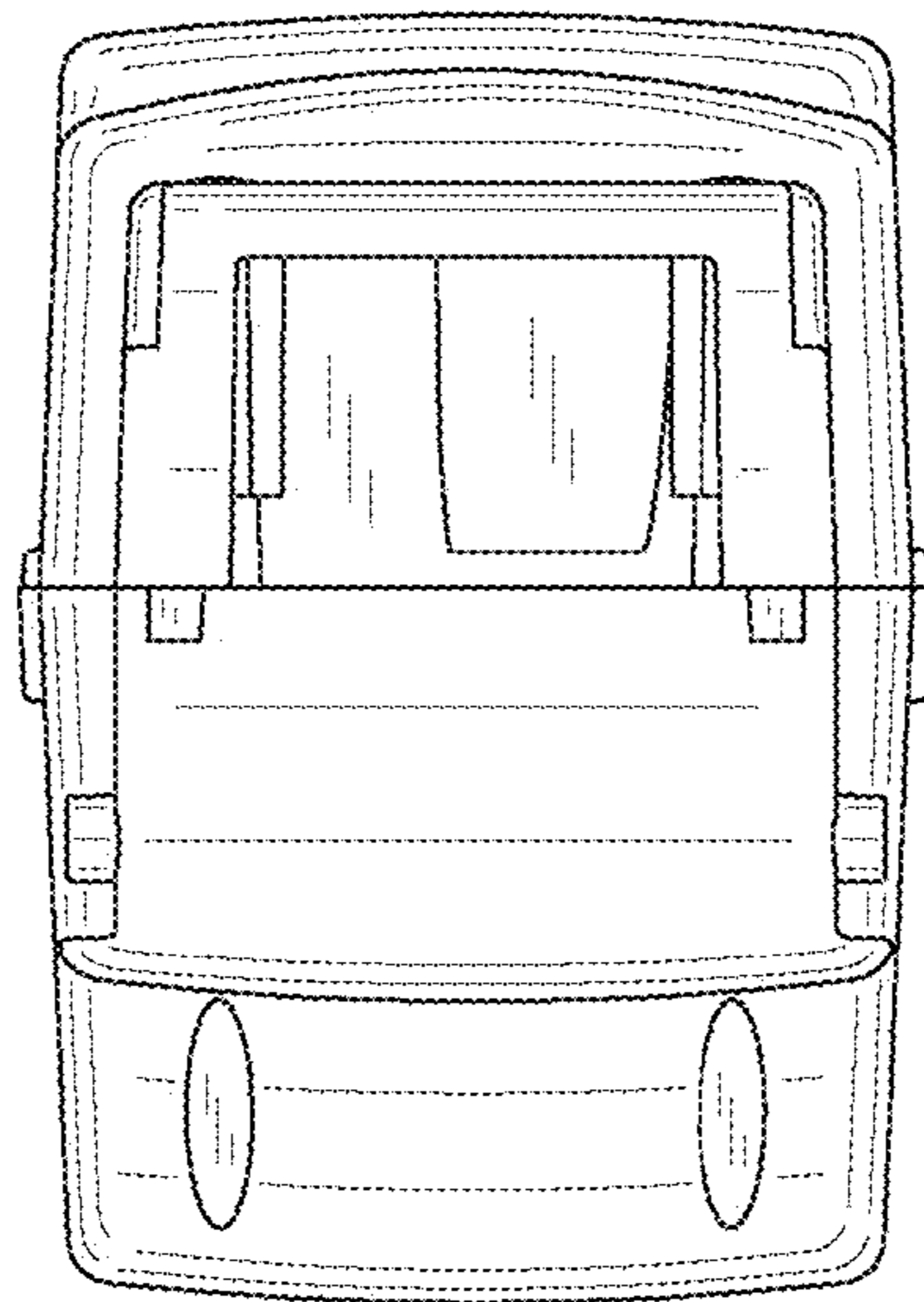

FIG. 5

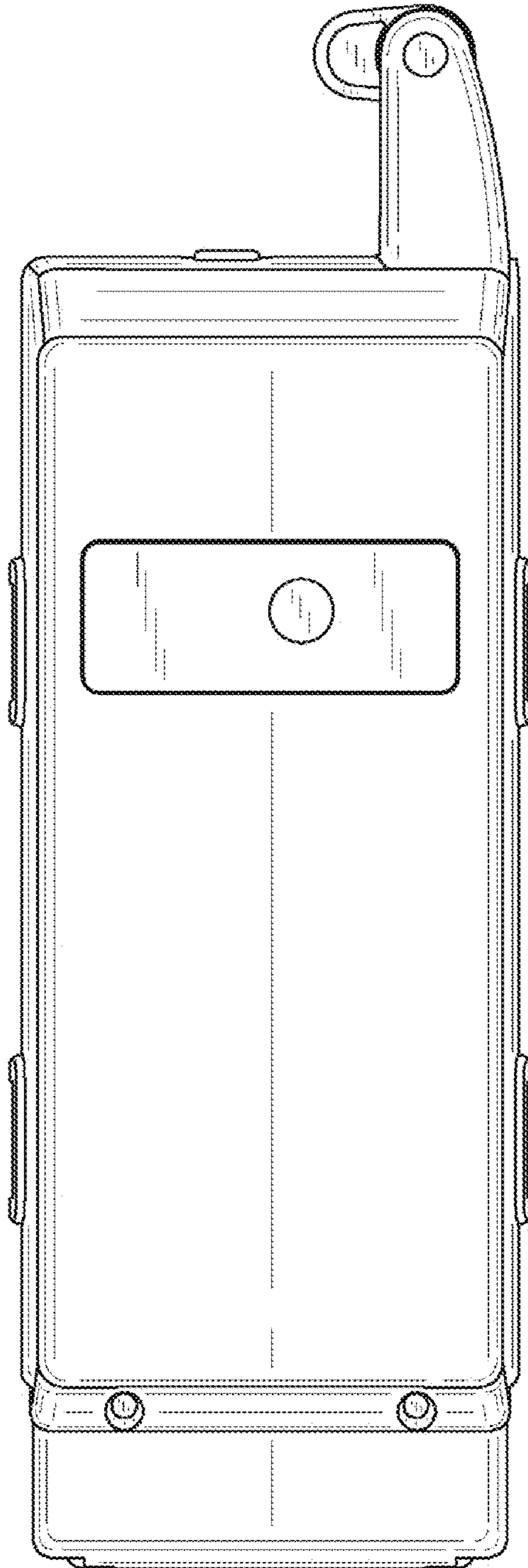

FIG.6

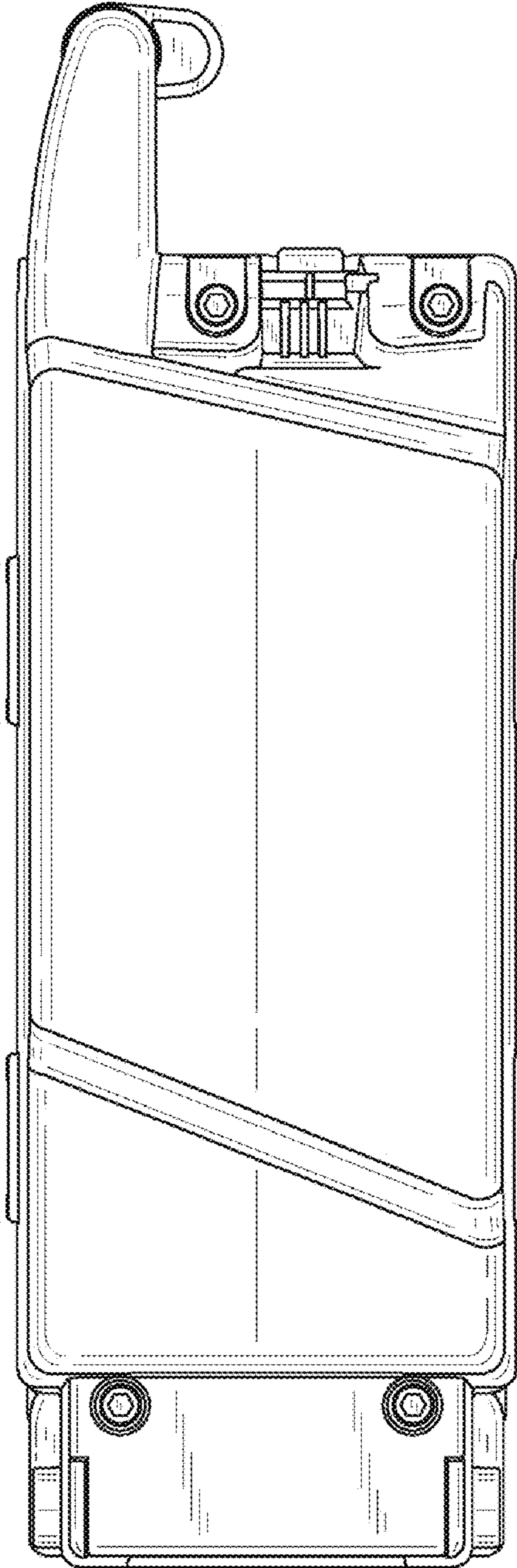

FIG. 7

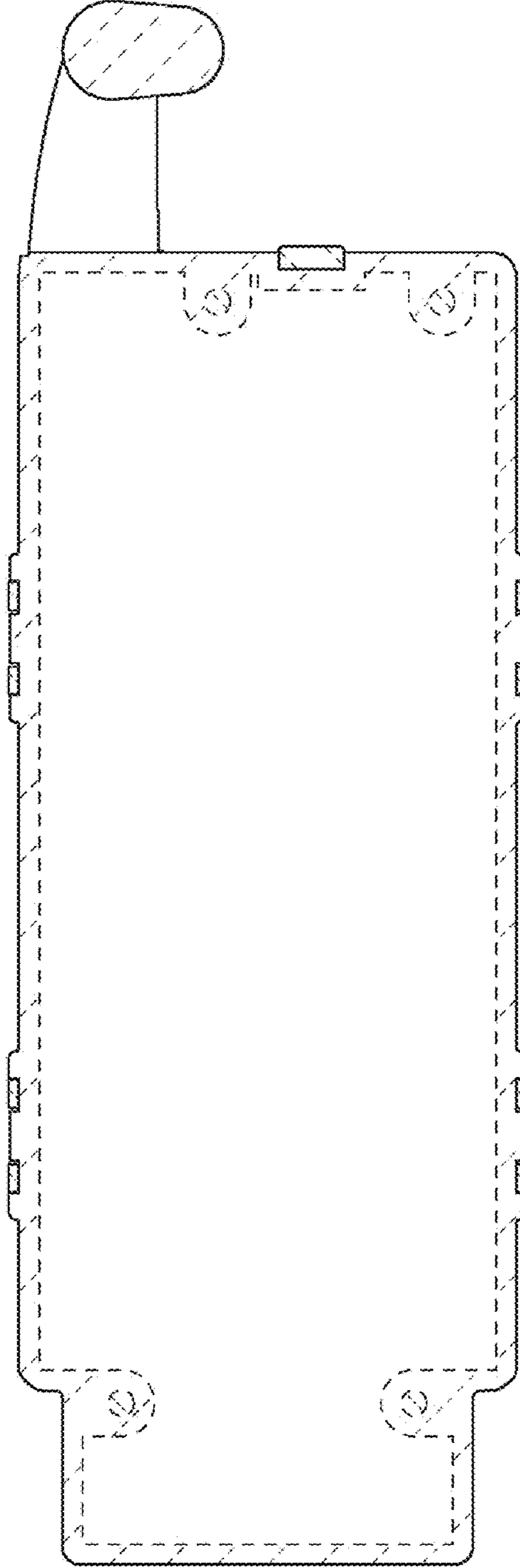

FIG.8