



US00D638707S

(12) **United States Design Patent**  
**Stoffers et al.**

(10) **Patent No.:** **US D638,707 S**

(45) **Date of Patent:** **\*\* May 31, 2011**

(54) **BOTTLE CAP**

(74) *Attorney, Agent, or Firm* — K&L Gates LLP

(75) Inventors: **Niels Stoffers**, Bloomington, MN (US);  
**Frank Gehindy**, Hochheim (DE)

(57) **CLAIM**  
The ornamental design for a bottle cap, as shown and described.

(73) Assignee: **Societe des Produits Nestle S.A.**, Vevey (CH)

**DESCRIPTION**

(\*\*) Term: **14 Years**

FIG. 1 illustrates a right front perspective view of the bottle cap showing my new design, wherein the broken line showings of the illustration thereon are for illustrative purposes only and form no part of the claimed design;

(21) Appl. No.: **29/363,348**

FIG. 2 illustrates a front elevation view thereof, wherein the rear elevation view, the right side elevation view and the left side elevation view are mirror images of this view;

(22) Filed: **Jun. 8, 2010**

(51) **LOC (9) Cl.** ..... **09-07**

FIG. 3 illustrates a top view thereof;

(52) **U.S. Cl.** ..... **D9/453; D9/451; D9/454**

FIG. 4 illustrates a bottom view thereof;

(58) **Field of Classification Search** ..... D9/651,  
D9/453, 452, 450, 449, 446, 443, 435; 222/83;  
220/277; 215/252, 216, 206, 222, 219

FIG. 5 illustrates a right front perspective view of a second alternative embodiment of the bottle cap showing my new design;

See application file for complete search history.

FIG. 6 illustrates a front elevation view of FIG. 5, wherein the rear elevation view, the right side elevation view and the left side elevation view are mirror images of this view;

(56) **References Cited**

**U.S. PATENT DOCUMENTS**

D503,886 S \* 4/2005 Biesecker ..... D9/435  
7,077,278 B2 \* 7/2006 Dubach ..... 215/252  
D613,162 S \* 4/2010 Druitt ..... D9/453

FIG. 7 illustrates a top view of FIG. 5; and,

FIG. 8 illustrates a bottom view of FIG. 5.

\* cited by examiner

The word "BOOST," forming part of an embodiment of the claimed design, is a registered trademark of Societe Des Produits Nestle, S.A., Vevey, Switzerland.

*Primary Examiner* — Susan Bennett Hattan

**1 Claim, 4 Drawing Sheets**

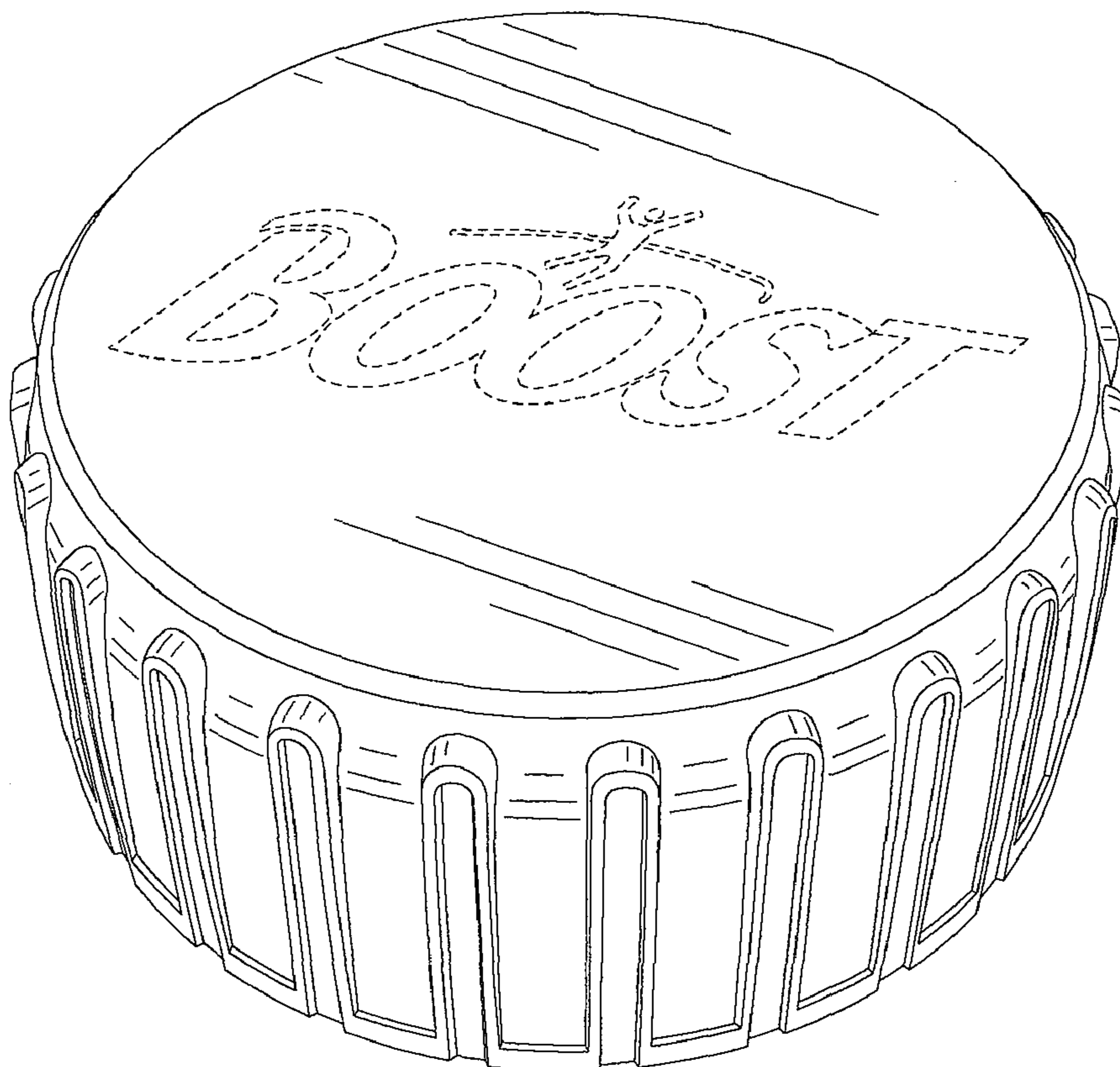

FIG. 1

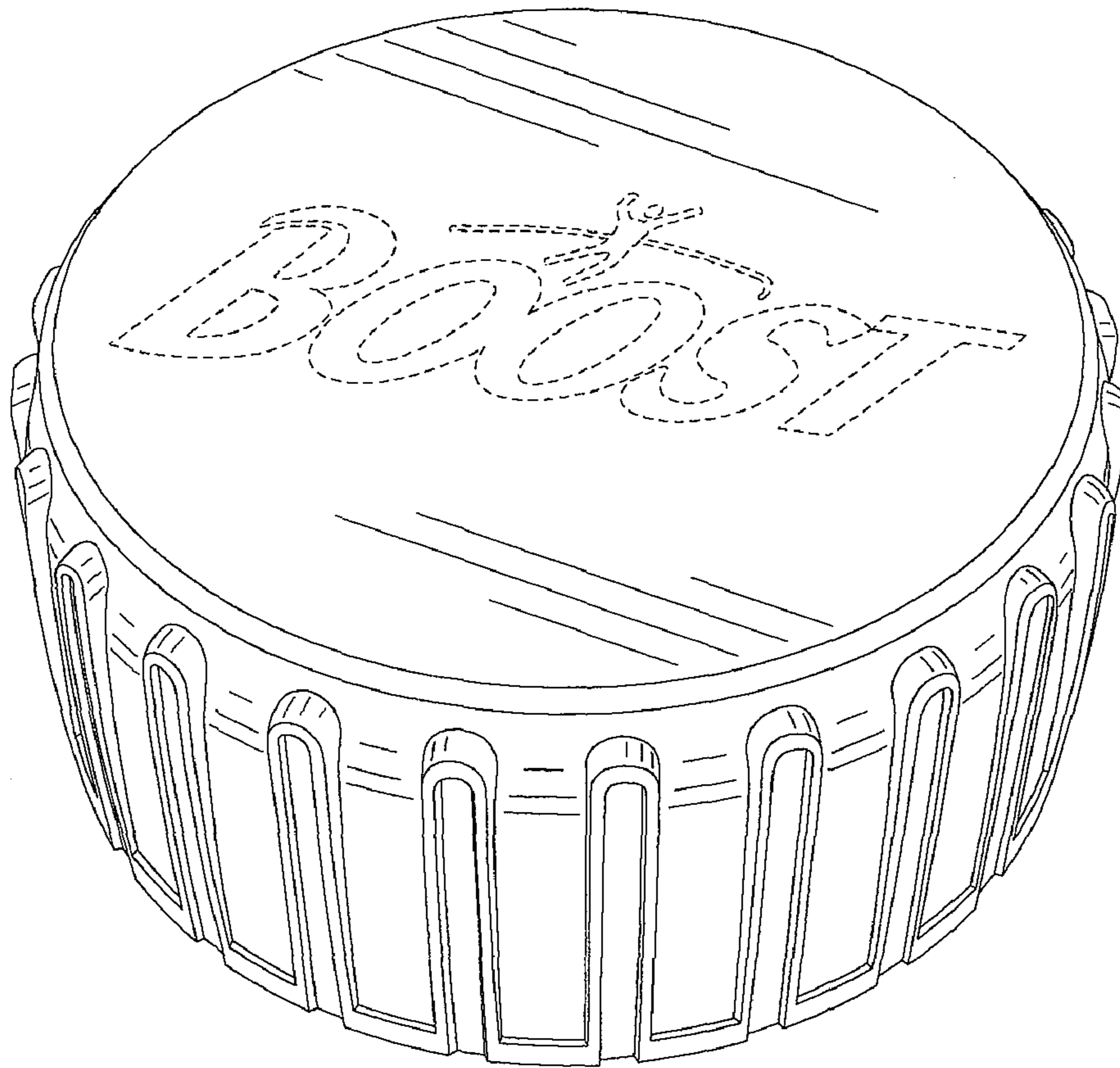

FIG. 2

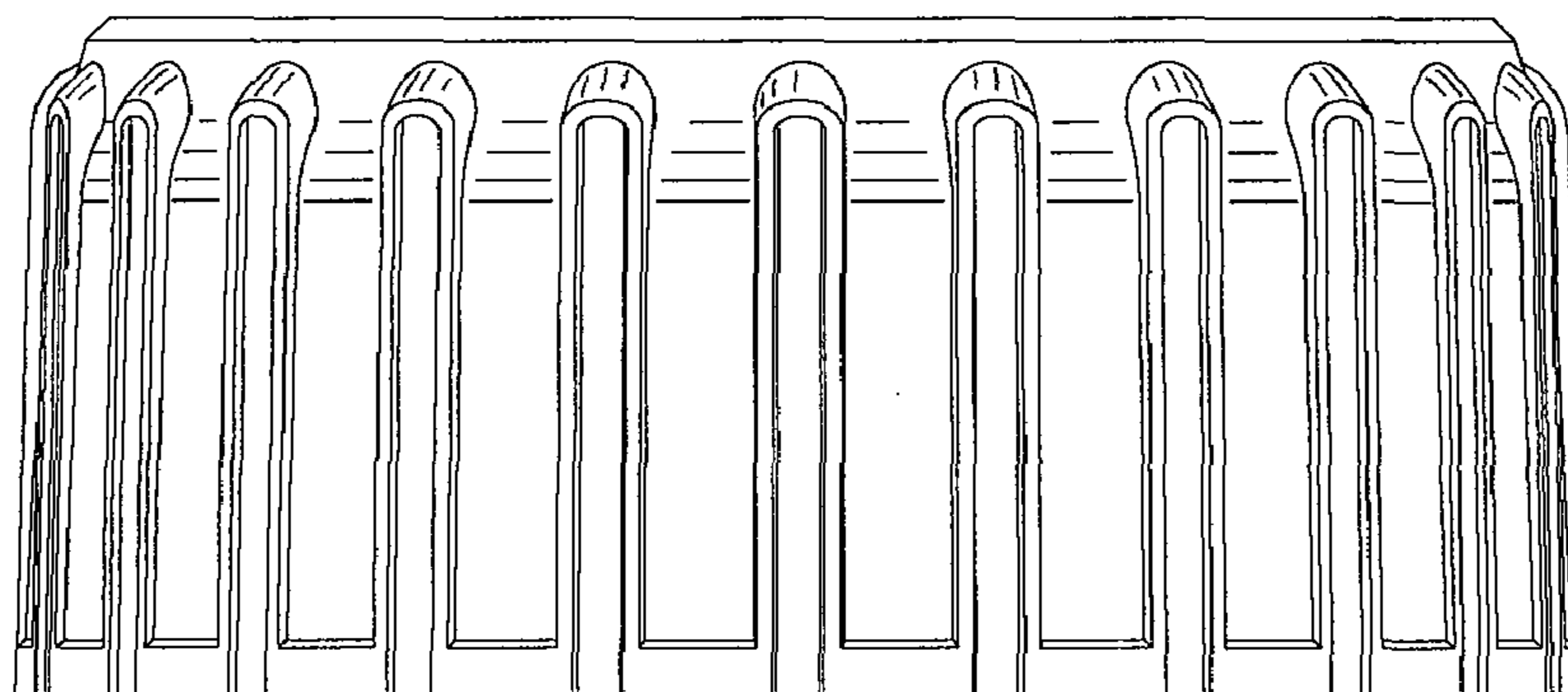

FIG. 3

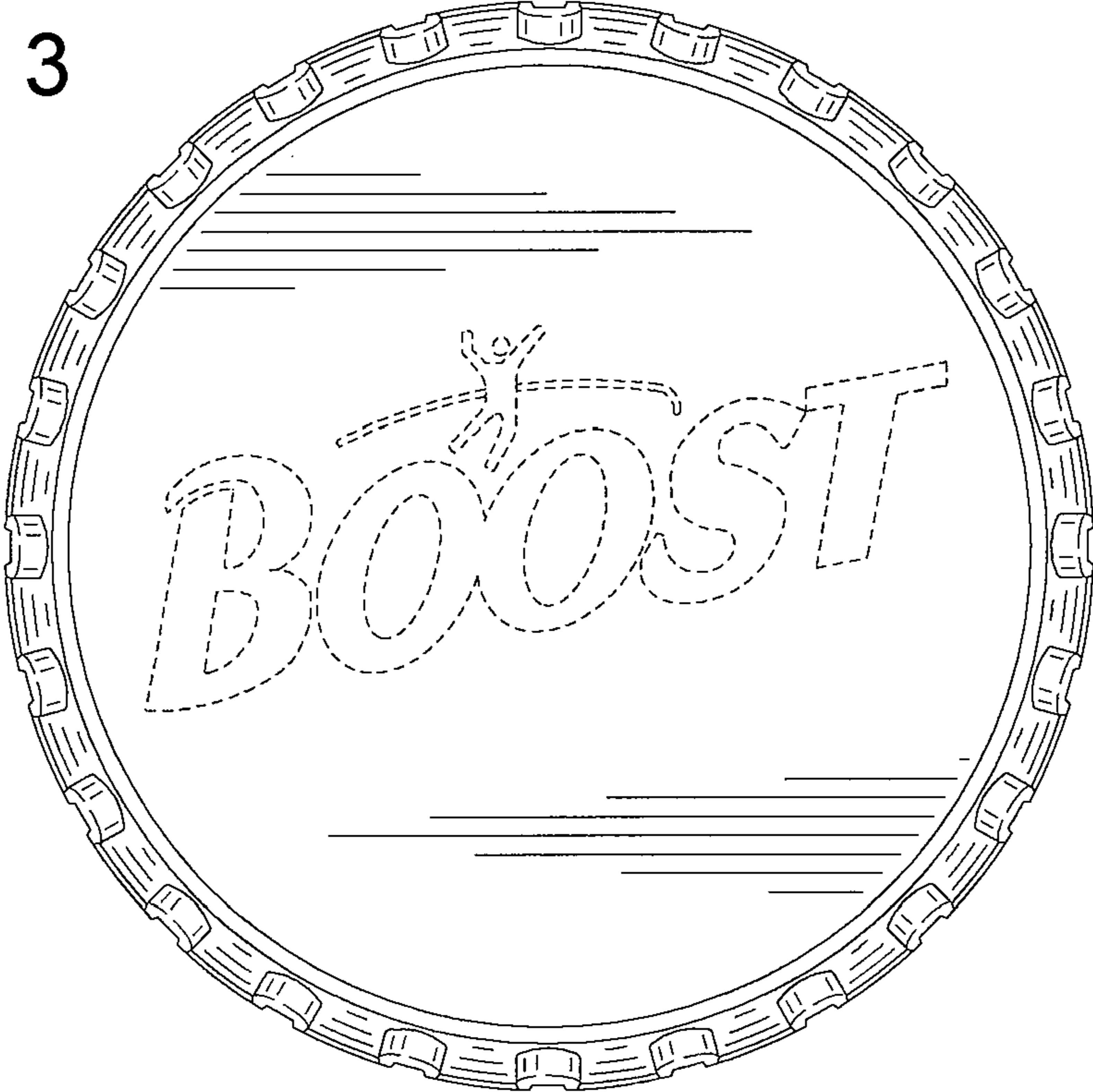

FIG. 4

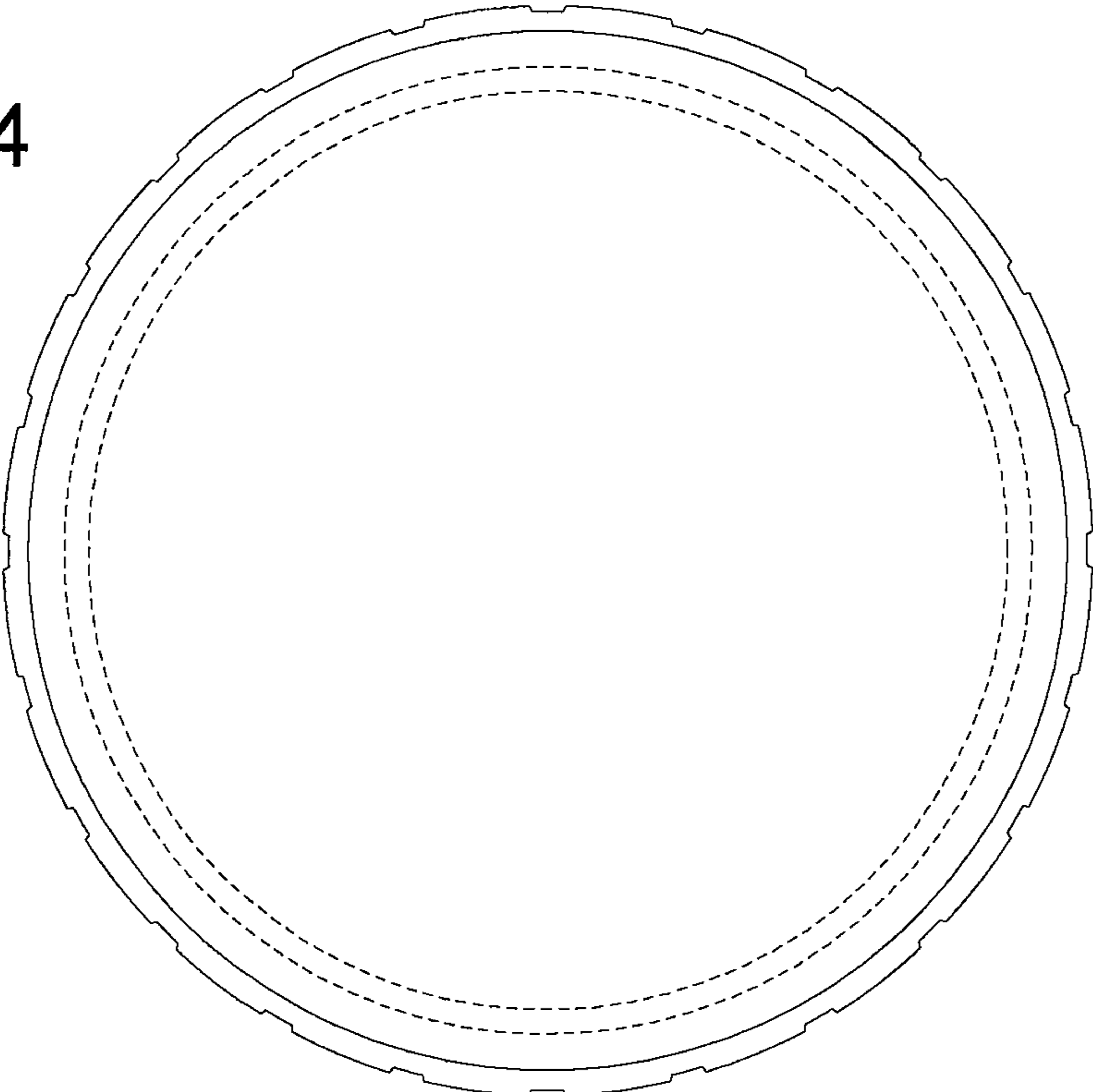

FIG. 5

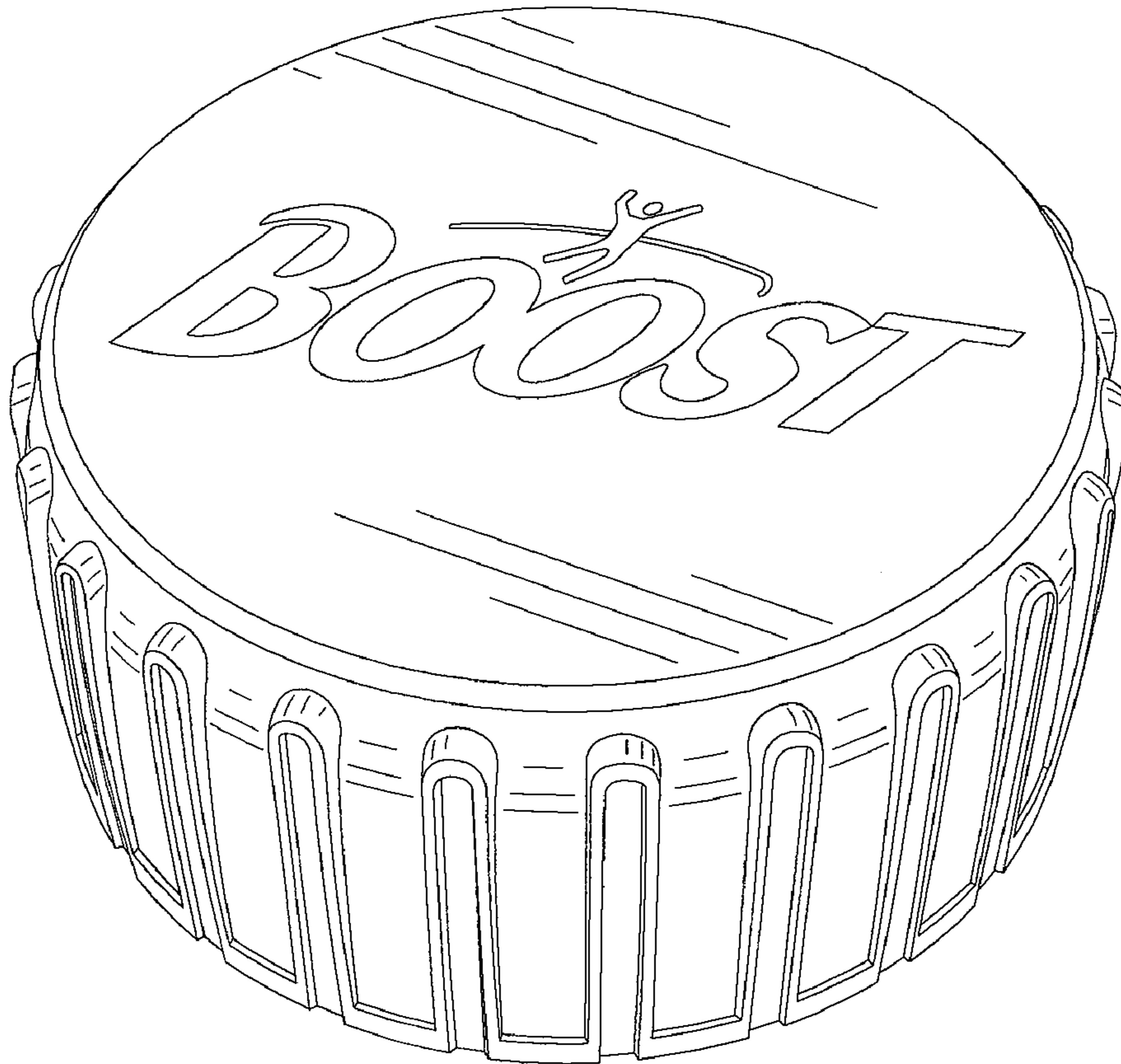

FIG. 6

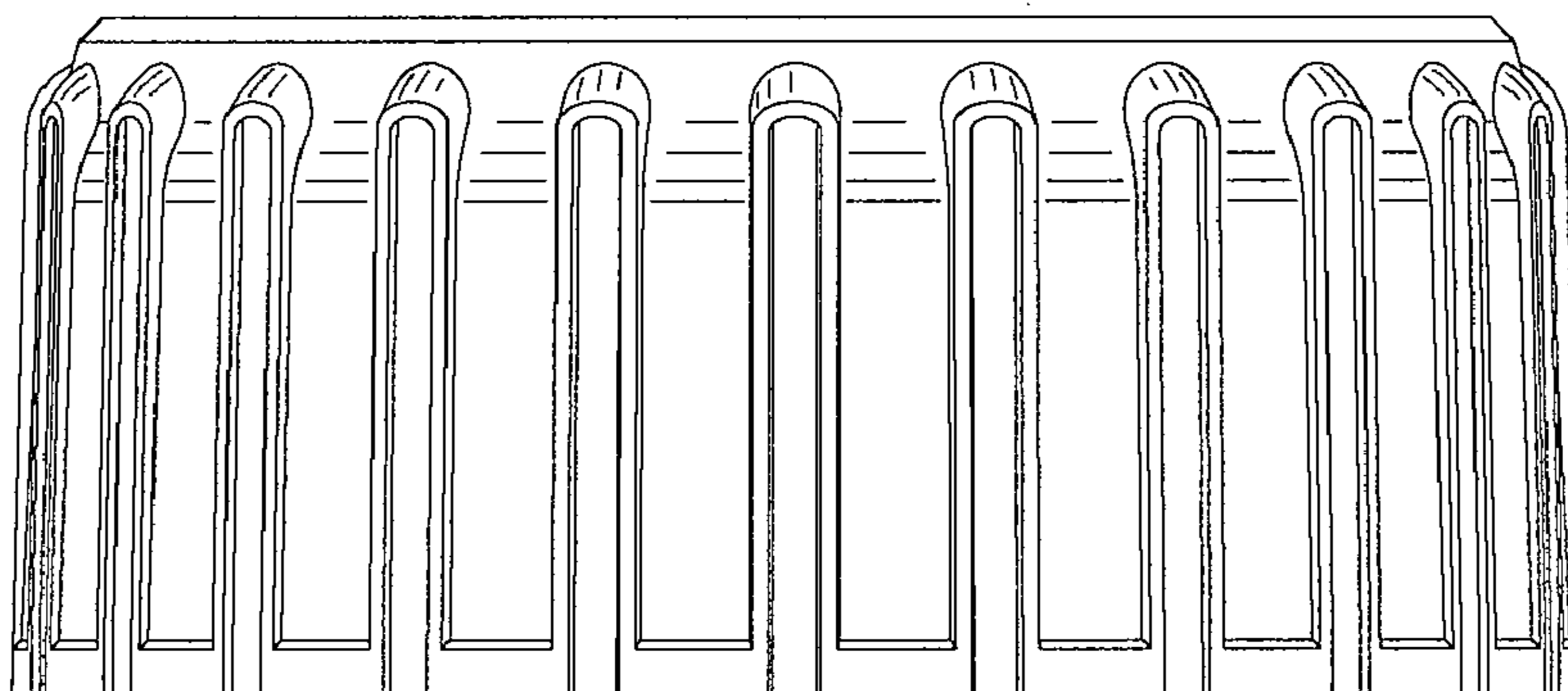

FIG. 7

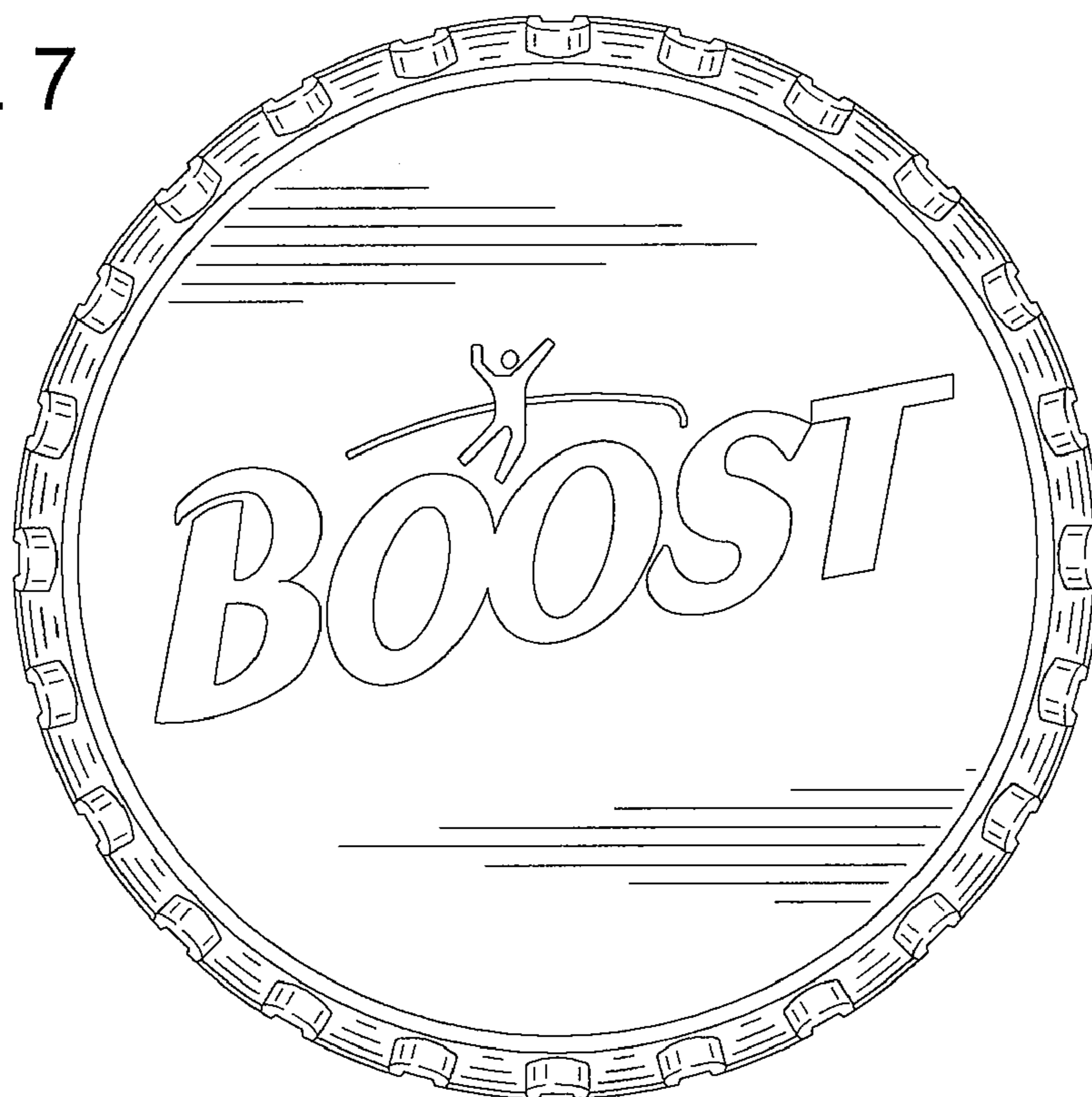

FIG. 8

