



US00D638703S

(12) **United States Design Patent**
Sovonick et al.

(10) **Patent No.:** **US D638,703 S**

(45) **Date of Patent:** **** *May 31, 2011**

(54) **CONTAINER WITH SURFACE ORNAMENTATION**

(75) Inventors: **Doug Sovonick**, Milford, OH (US); **Rob Anthony**, Cincinnati, OH (US)

(73) Assignee: **The Procter & Gamble Company**, Cincinnati, OH (US)

(*) Notice: This patent is subject to a terminal disclaimer.

(**) Term: **14 Years**

(21) Appl. No.: **29/327,489**

(22) Filed: **Nov. 6, 2008**

(51) **LOC (9) Cl.** **09-07**

(52) **U.S. Cl.** **D9/434; D9/600**

(58) **Field of Classification Search** D9/600,
D9/645-646, 652, 667, 500-503, 516-517,
D9/549-552, 434; 206/457-458, 527; 220/890
See application file for complete search history.

(56) **References Cited**

U.S. PATENT DOCUMENTS

D581,263 S *	11/2008	Suyama et al.	D9/415
D589,359 S *	3/2009	Kusumi	D9/600
D599,201 S *	9/2009	Seol et al.	D9/432
D603,701 S *	11/2009	Seol et al.	D9/432

OTHER PUBLICATIONS

Earlier Pepto-Bismol Packaging Drawings.

* cited by examiner

Primary Examiner — Sandra Morris

(74) *Attorney, Agent, or Firm* — Cynthia L. Clay; Kim William Zerby

(57) **CLAIM**

The ornamental design for container with surface ornamentation, as shown and described.

DESCRIPTION

FIG. 1 is a perspective view of a container with surface ornamentation embodying our new design;
 FIG. 2 is a front view thereof;
 FIG. 3 is a left side view thereof;
 FIG. 4 is a right side view thereof;
 FIG. 5 is a rear view thereof;
 FIG. 6 is a top view thereof;
 FIG. 7 is a bottom view thereof;
 FIG. 8 is a perspective view of a second embodiment of a container with surface ornamentation embodying our new design;
 FIG. 9 is a front view thereof;
 FIG. 10 is a left side view thereof;
 FIG. 11 is a right side view thereof;
 FIG. 12 is a perspective view of a third embodiment of a container with surface ornamentation embodying our new design;
 FIG. 13 is a front view thereof;
 FIG. 14 is a left side view thereof; and,
 FIG. 15 is a right side view thereof.

Broken lines are included herein for illustrative purposes only and form no part of the claimed design. In FIG. 1-15, the stippling represents no particular color or colors. The rear, top and bottom views of the embodiments of FIGS. 8 and 12 are the same as FIGS. 5, 6, and 7 respectively.

1 Claim, 7 Drawing Sheets

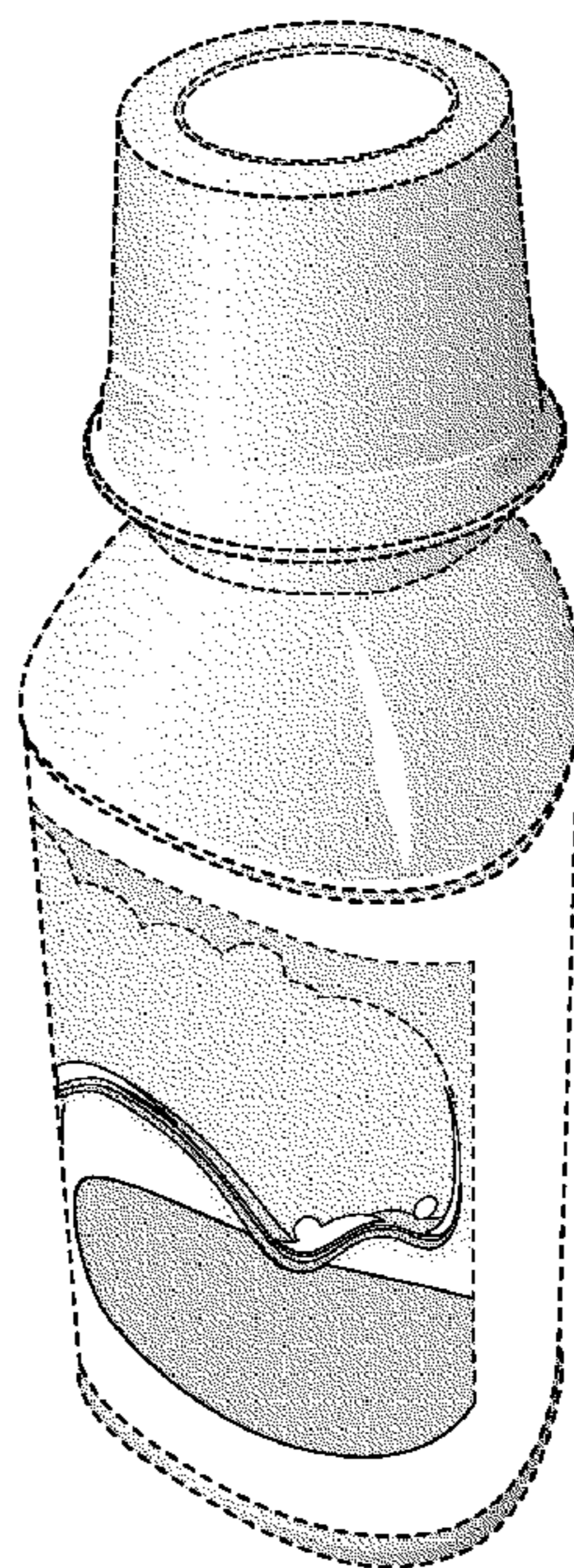

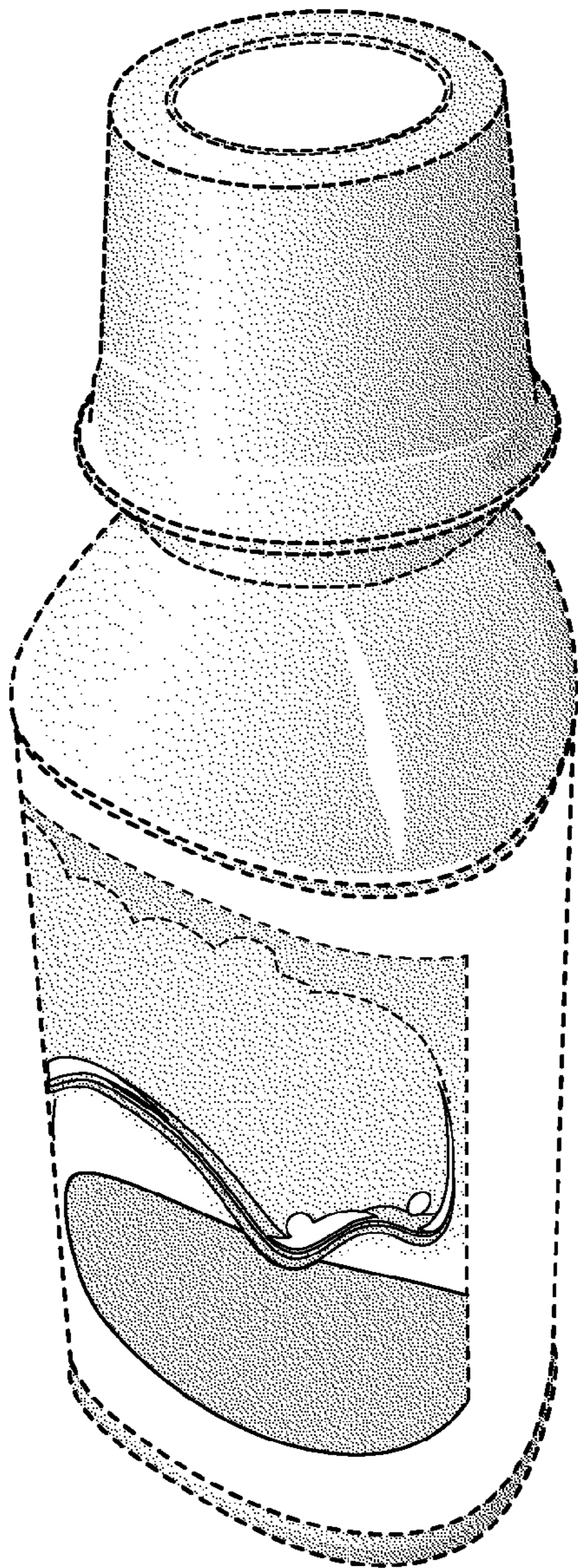

Fig. 1

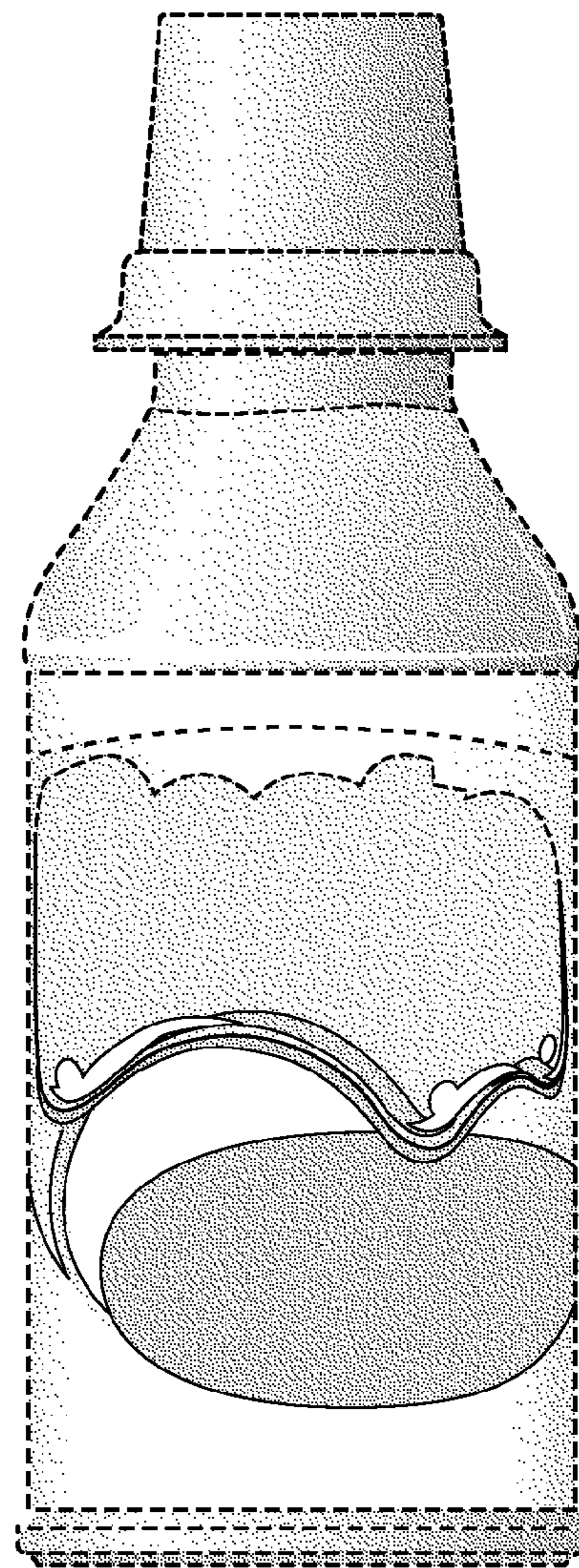

Fig. 2

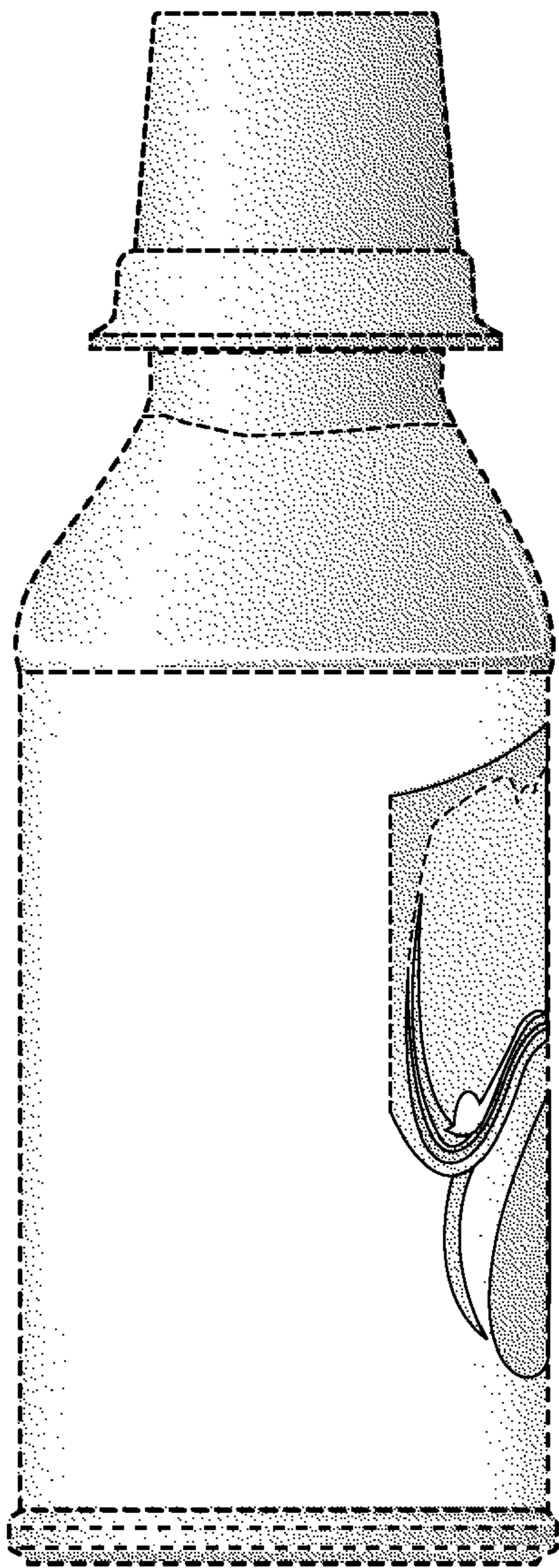

Fig. 3

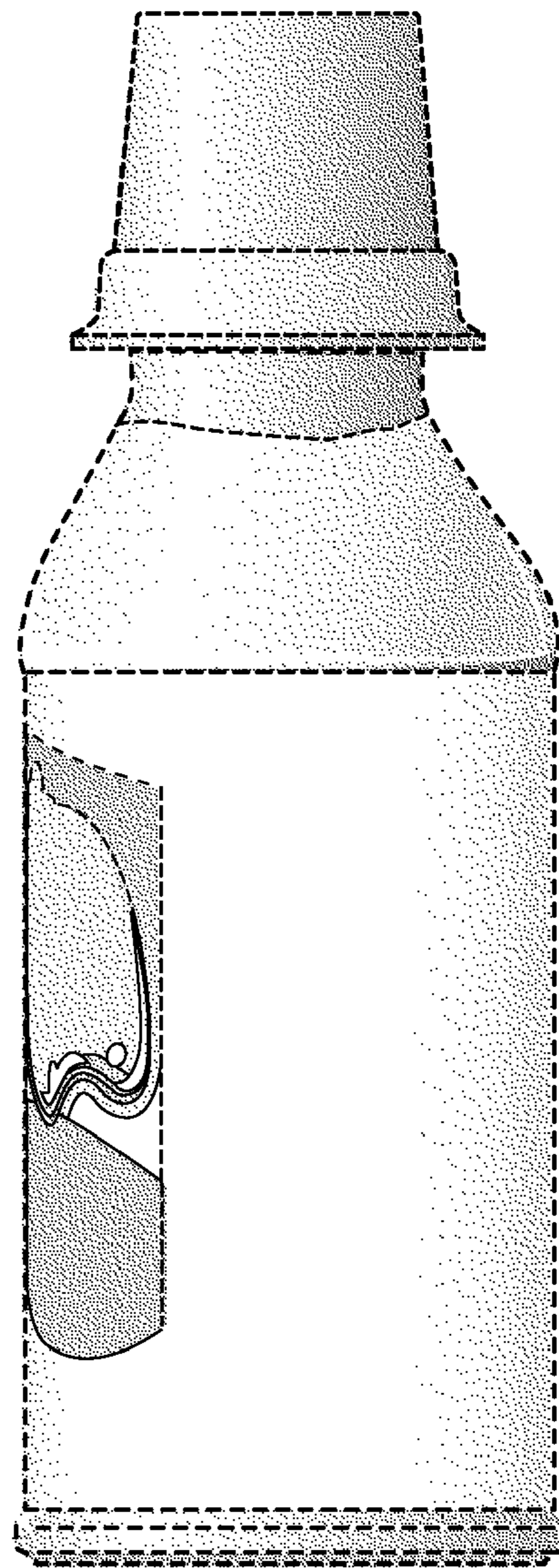

Fig. 4

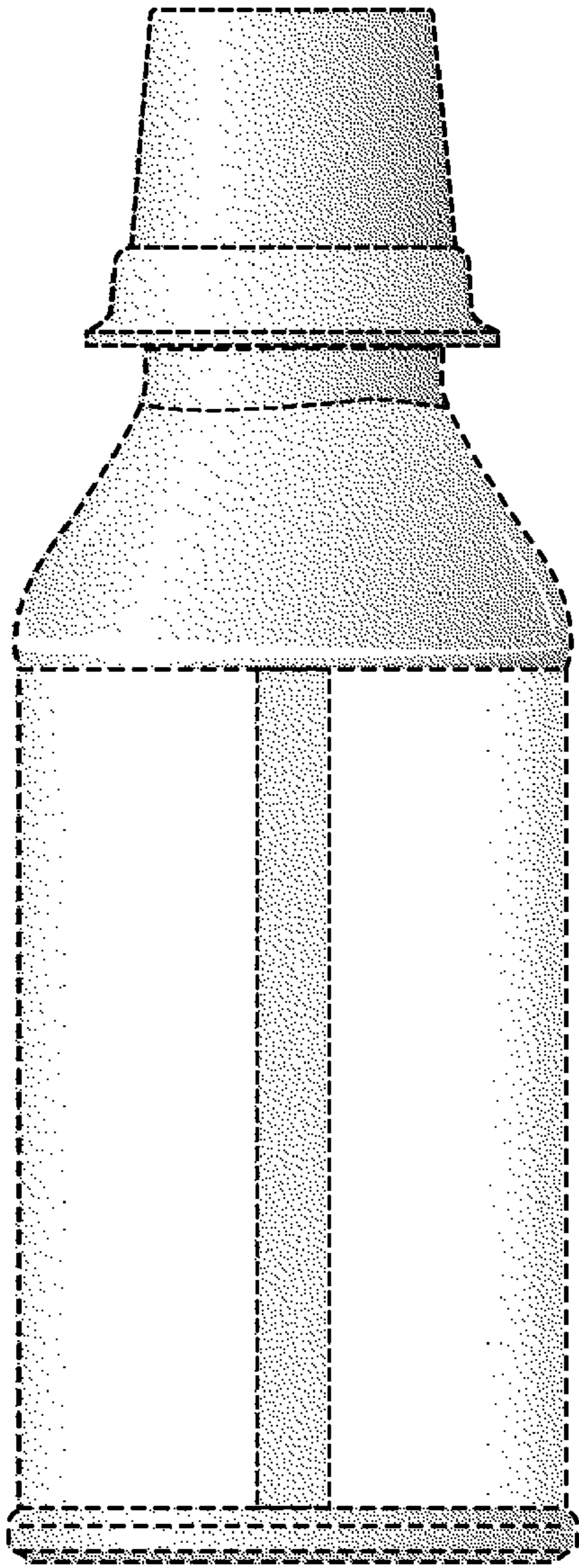

Fig. 5

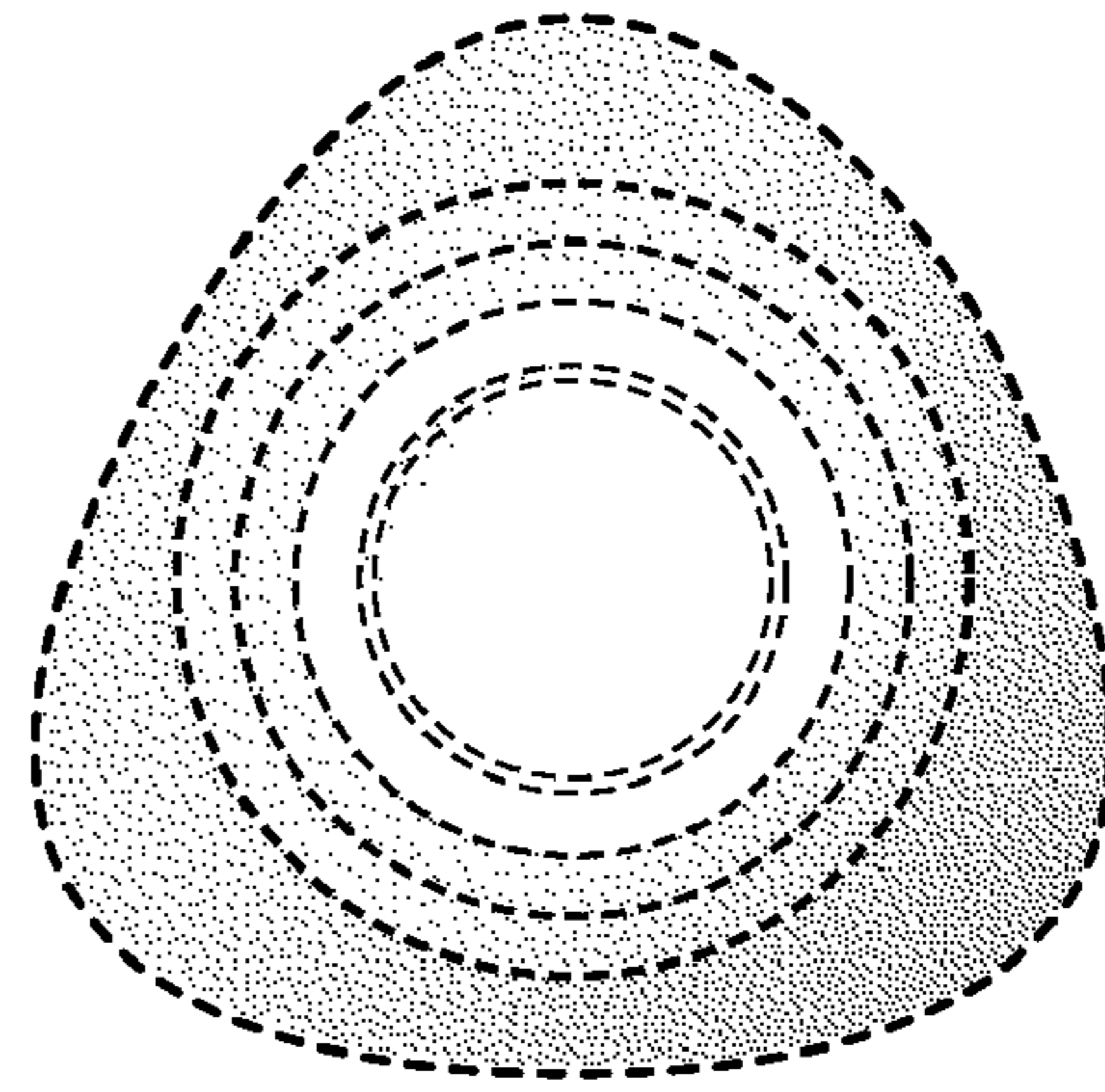

Fig. 6

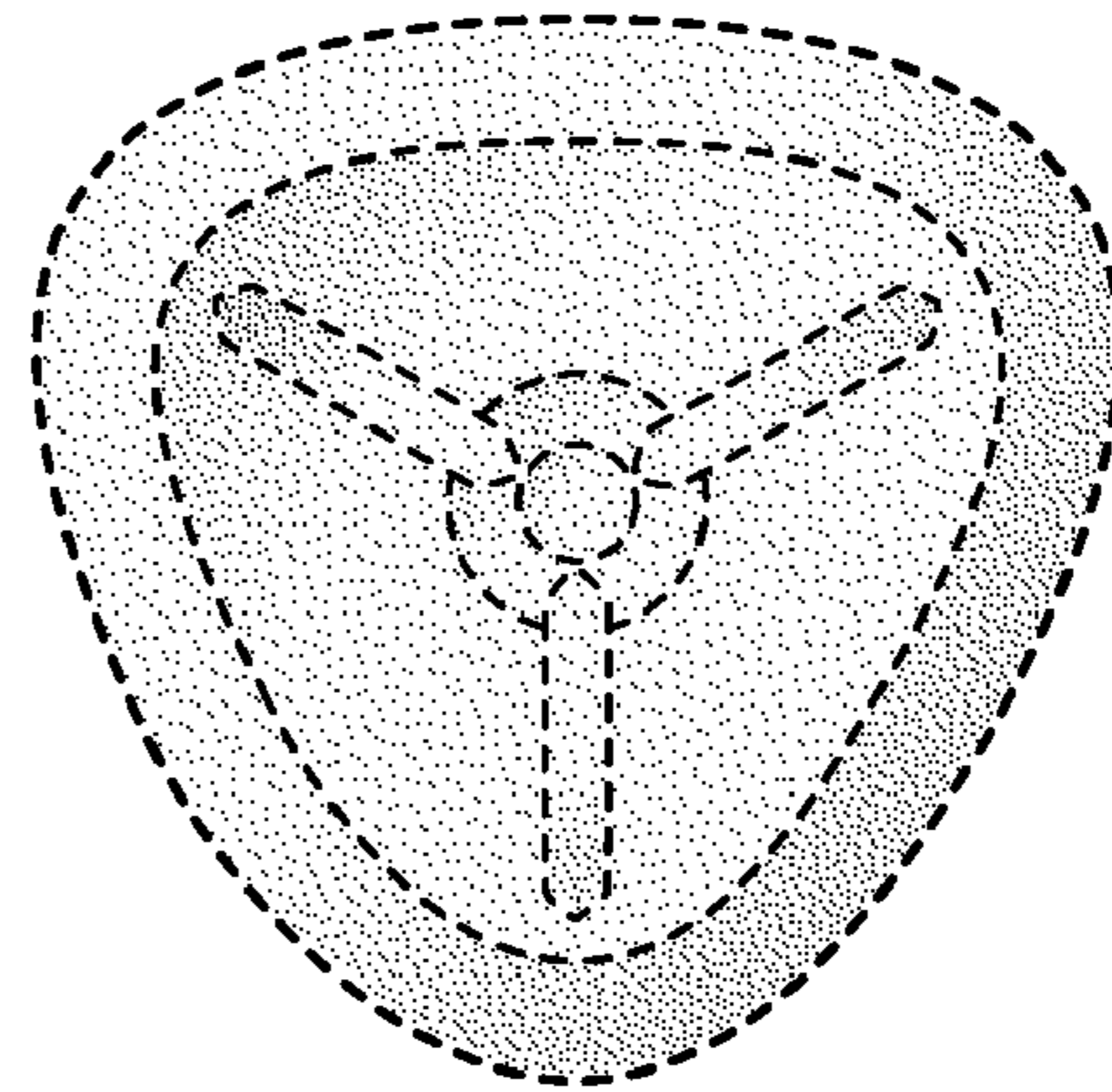

Fig. 7

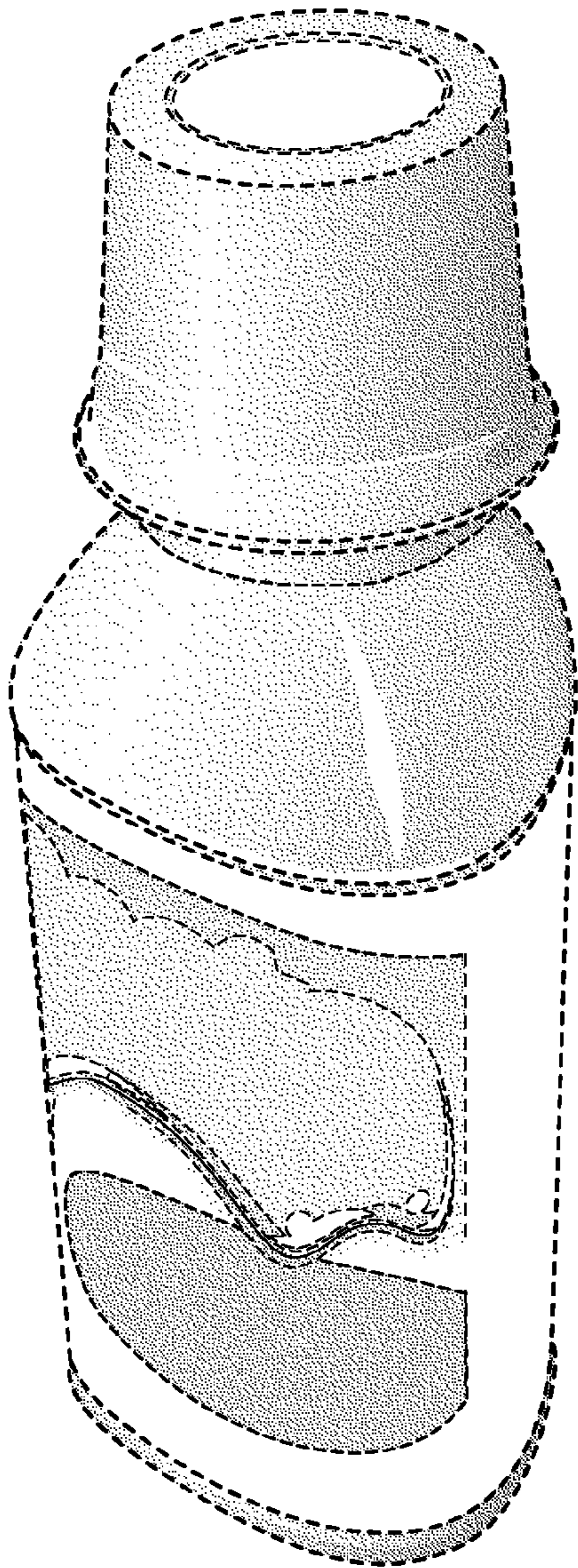

Fig. 8

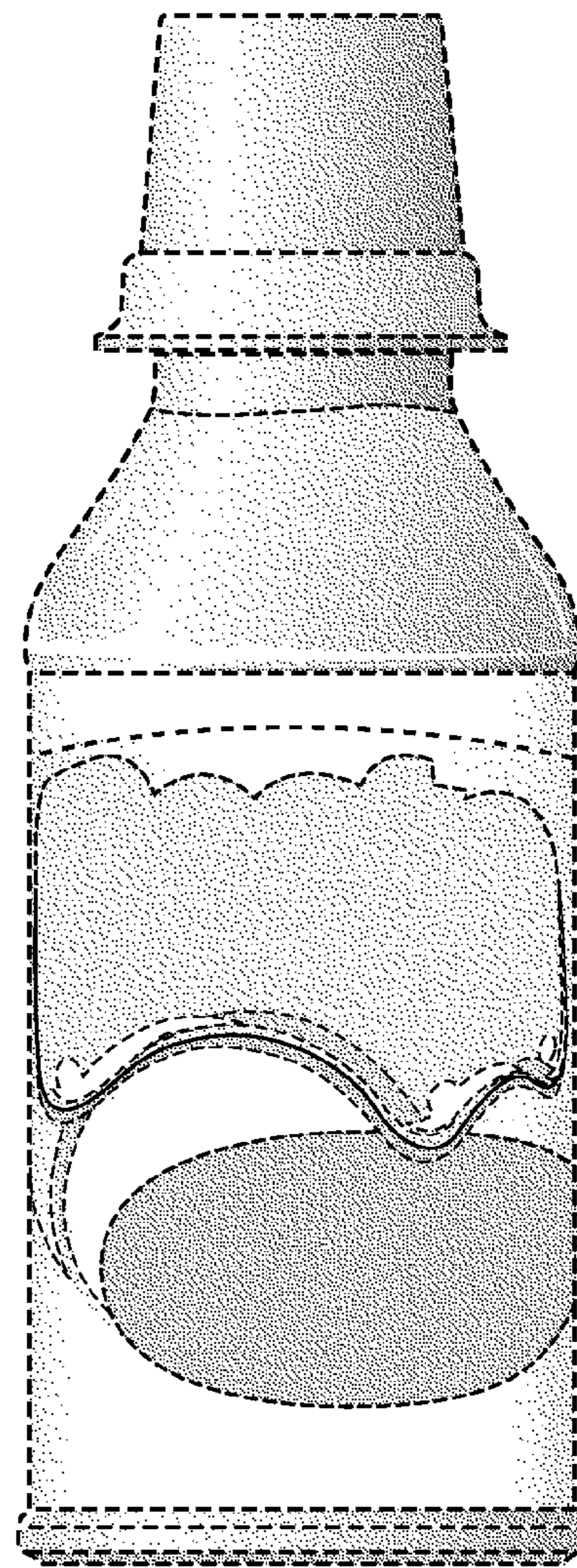

Fig. 9

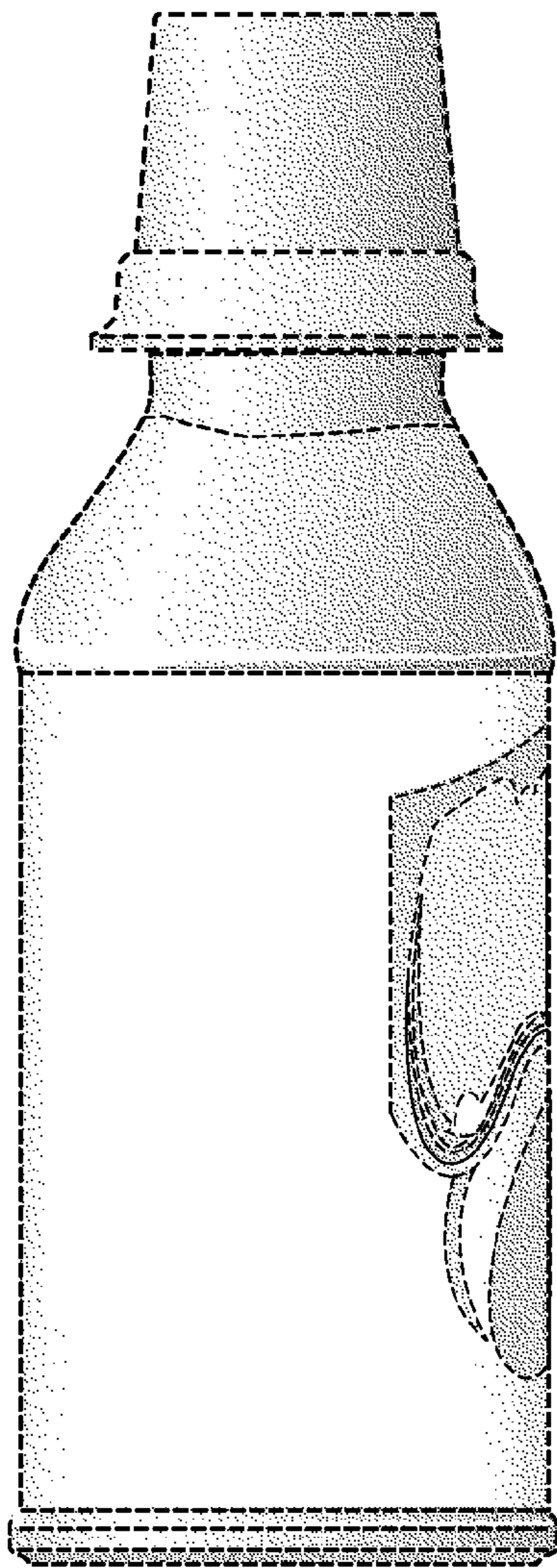

Fig. 10

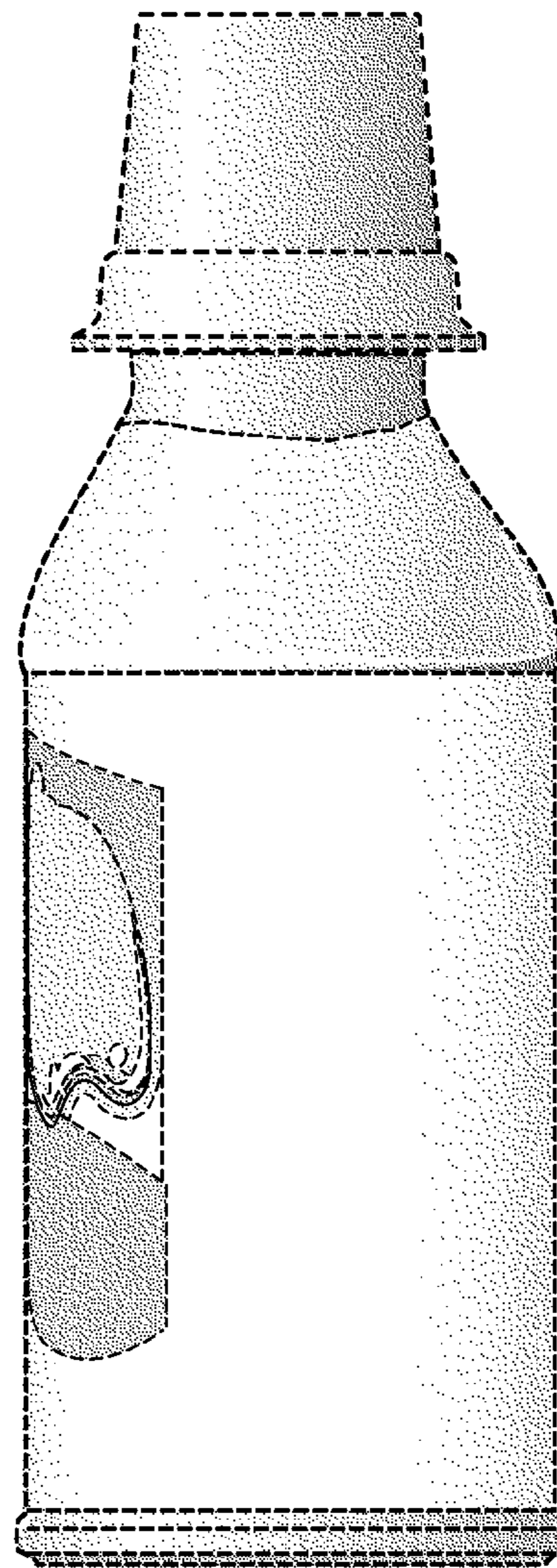

Fig. 11

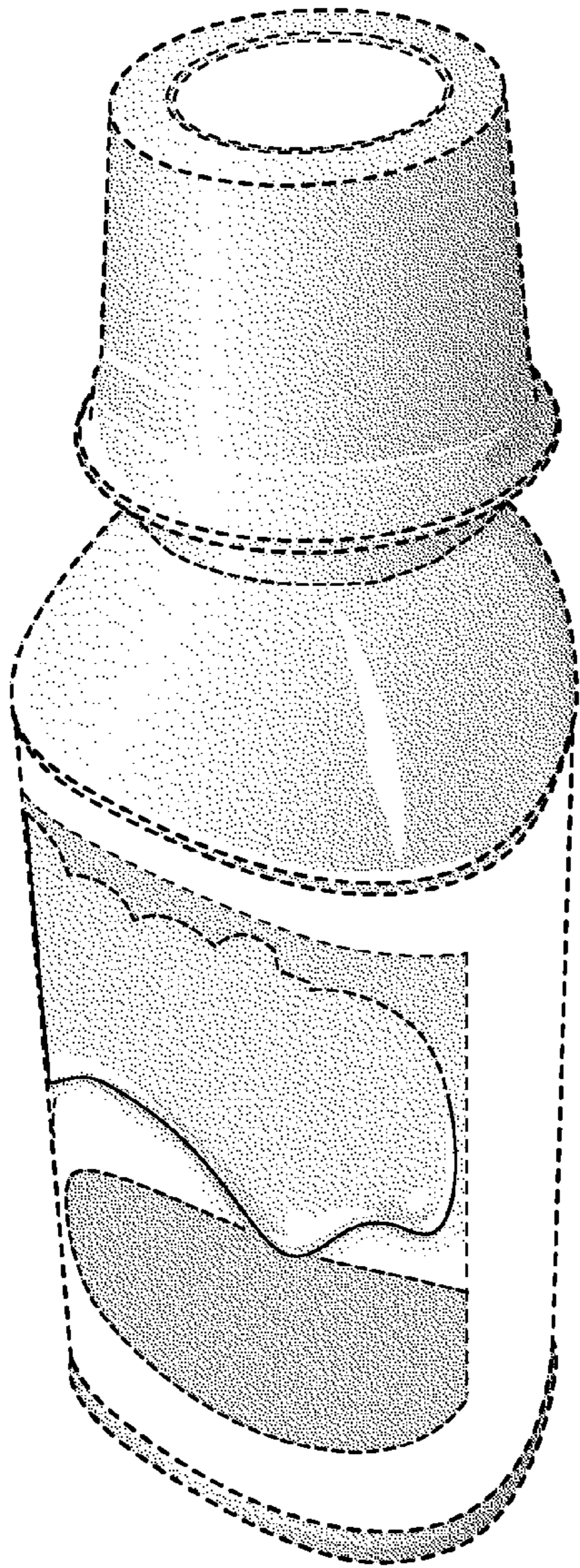

Fig. 12

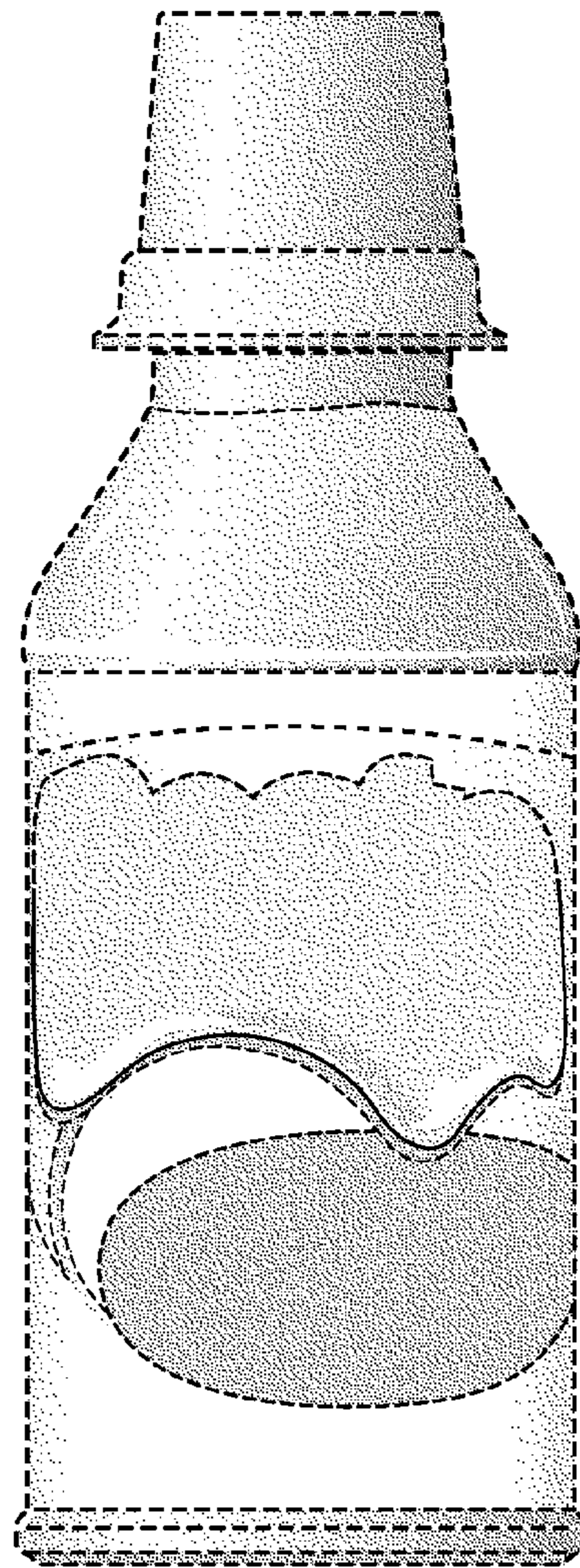

Fig. 13

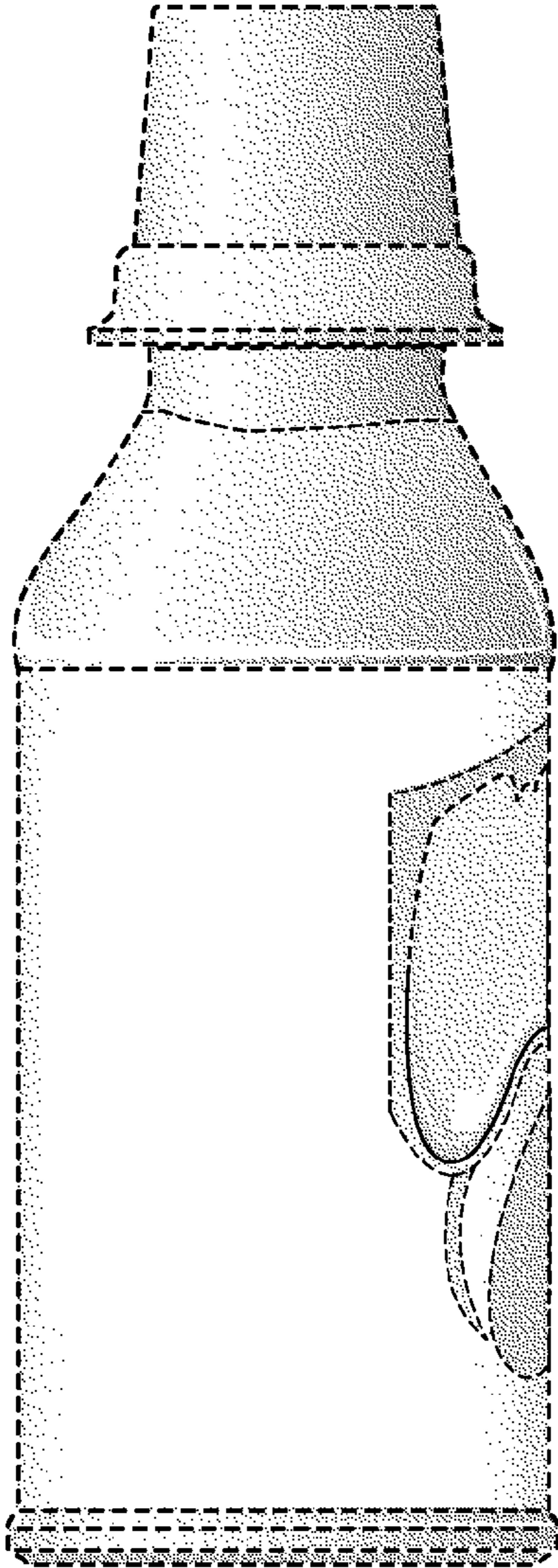

Fig. 14

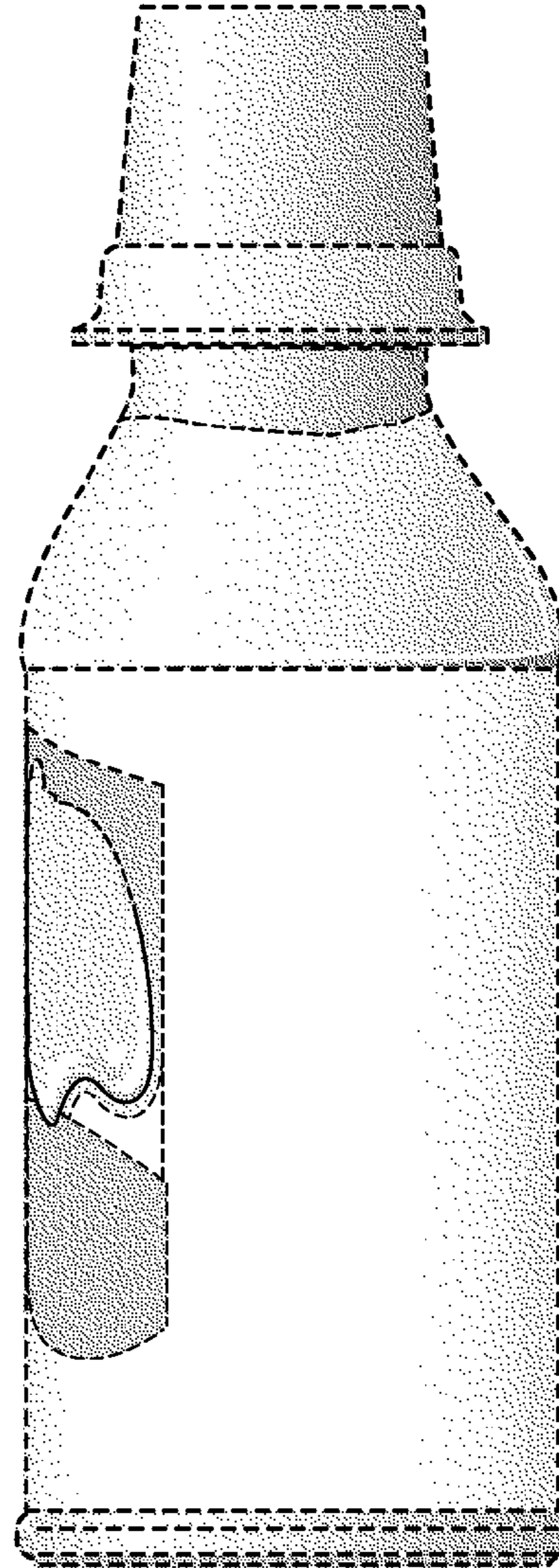

Fig. 15