



US00D638683S

(12) **United States Design Patent**
Igeta

(10) **Patent No.:** **US D638,683 S**

(45) **Date of Patent:** **** May 31, 2011**

(54) **DOOR HANDLE FOR AUTOMOBILE**

(75) Inventor: **Makoto Igeta**, Kanagawa (JP)

(73) Assignee: **Alpha Corporation**, Yokohama-shi,
Kanagawa (JP)

(**) Term: **14 Years**

(21) Appl. No.: **29/343,388**

(22) Filed: **Sep. 11, 2009**

(30) **Foreign Application Priority Data**

Mar. 13, 2009 (JP) 2009-005662

(51) **LOC (9) Cl.** **08-06**

(52) **U.S. Cl.** **D8/302**

(58) **Field of Classification Search** D8/300,
D8/302, 308, 313, 331, 338, 341, DIG. 10,
D8/305, 301, 321; 16/110.1, 412, 402; 292/336.3,
292/347, 348; 70/224; D12/190, 196; 280/1;
D26/85, 118, 119, 120, 122; 362/600, 609,
362/612, 364; D16/136, 137, 134, 330, 341,
D16/342; D21/385, 386
See application file for complete search history.

(56) **References Cited**

U.S. PATENT DOCUMENTS

907,203	A *	12/1908	Walker	273/157 R
2,592,078	A *	4/1952	Taylor et al.	446/100
3,507,132	A *	4/1970	Schwenk	70/224
4,395,932	A *	8/1983	Mills	84/322
4,555,114	A *	11/1985	Dozier	473/588
4,643,683	A *	2/1987	Orsini et al.	434/403
4,831,345	A *	5/1989	Schiavone	333/128

4,883,296	A *	11/1989	Laurie	292/336.3
4,890,531	A *	1/1990	Tischer	84/329
4,913,436	A *	4/1990	Li	273/157 R
5,796,021	A *	8/1998	Longshore	84/329
6,363,577	B1 *	4/2002	Spitzley	292/336.3
6,612,630	B1 *	9/2003	Meinke	292/348
6,719,336	B2 *	4/2004	Sato	292/336.3
6,880,870	B2 *	4/2005	Costigan	292/336.3
D536,595	S *	2/2007	Sakamoto et al.	D8/302
D548,872	S *	8/2007	Dubbeldam et al.	D26/85
D585,719	S *	2/2009	Imai et al.	D8/302
D588,436	S *	3/2009	Larson	D8/302
D593,396	S *	6/2009	Habib	D8/308

* cited by examiner

Primary Examiner — Paula Greene

(74) *Attorney, Agent, or Firm* — Drinker Biddle & Reath
LLP

(57) **CLAIM**

The ornamental design for a door handle for automobile, as shown and described.

DESCRIPTION

FIG. 1 is a perspective view of the front, right and bottom of a door handle for automobile showing my new design;
 FIG. 2 is a front view thereof;
 FIG. 3 is a rear view thereof;
 FIG. 4 is a right side view thereof;
 FIG. 5 is a left side view thereof;
 FIG. 6 is a top plan view thereof thereof;
 FIG. 7 is a bottom view thereof; and,
 FIG. 8 is an end view at 8—8 shown in the FIG. 7 omitting interior mechanism thereof.
 The elements shown in broken lines are for illustrative purposes only and form no part of the claimed design.

1 Claim, 5 Drawing Sheets

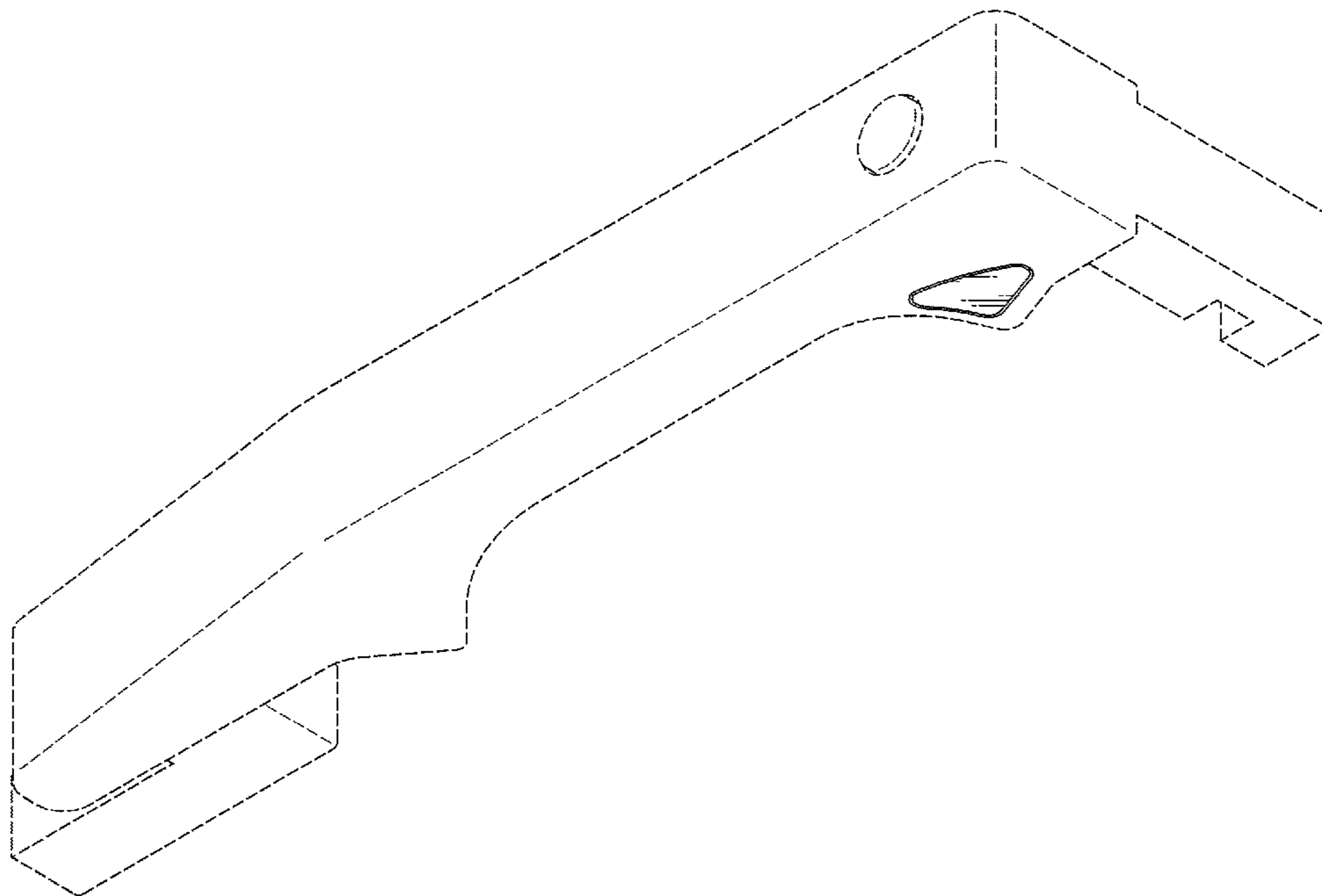

FIG.1

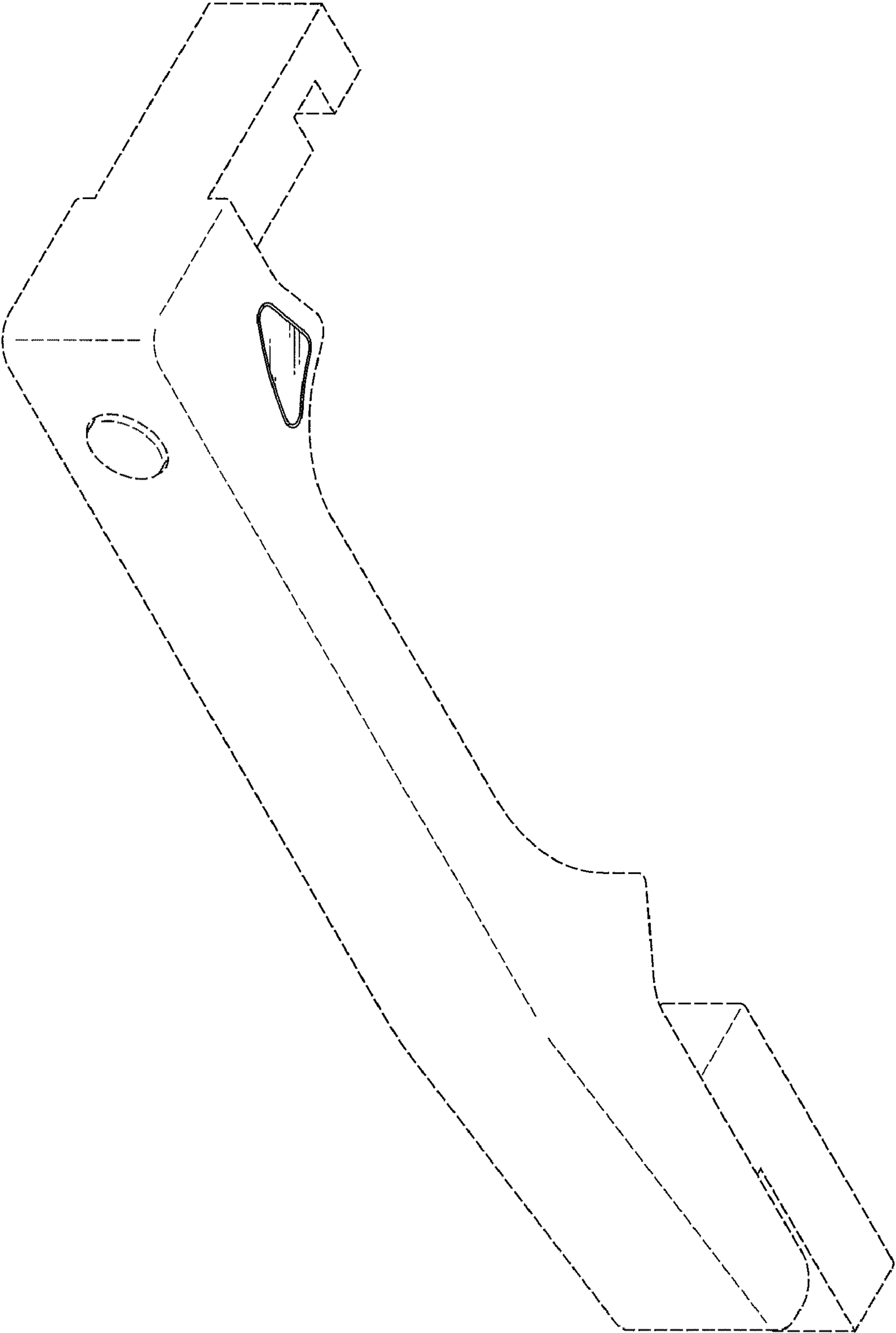

FIG.2

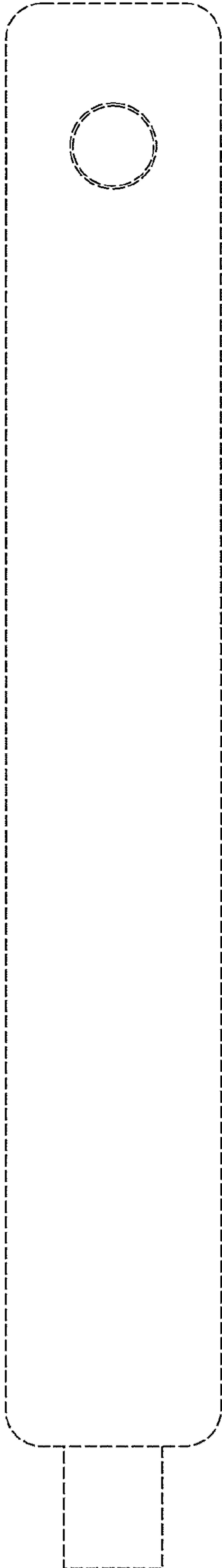

FIG.3

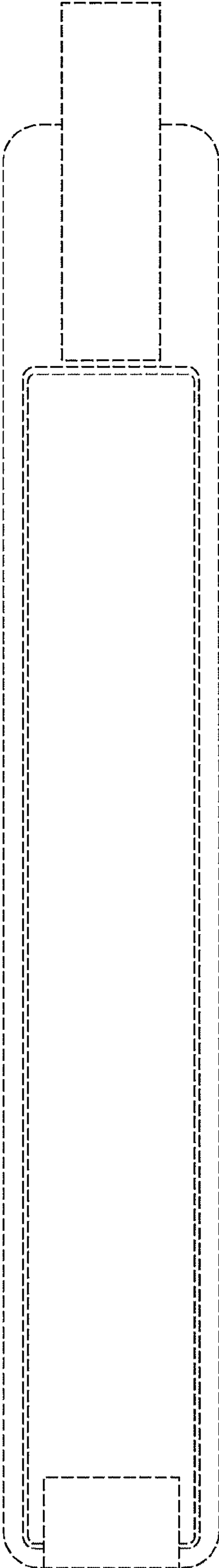

FIG.4

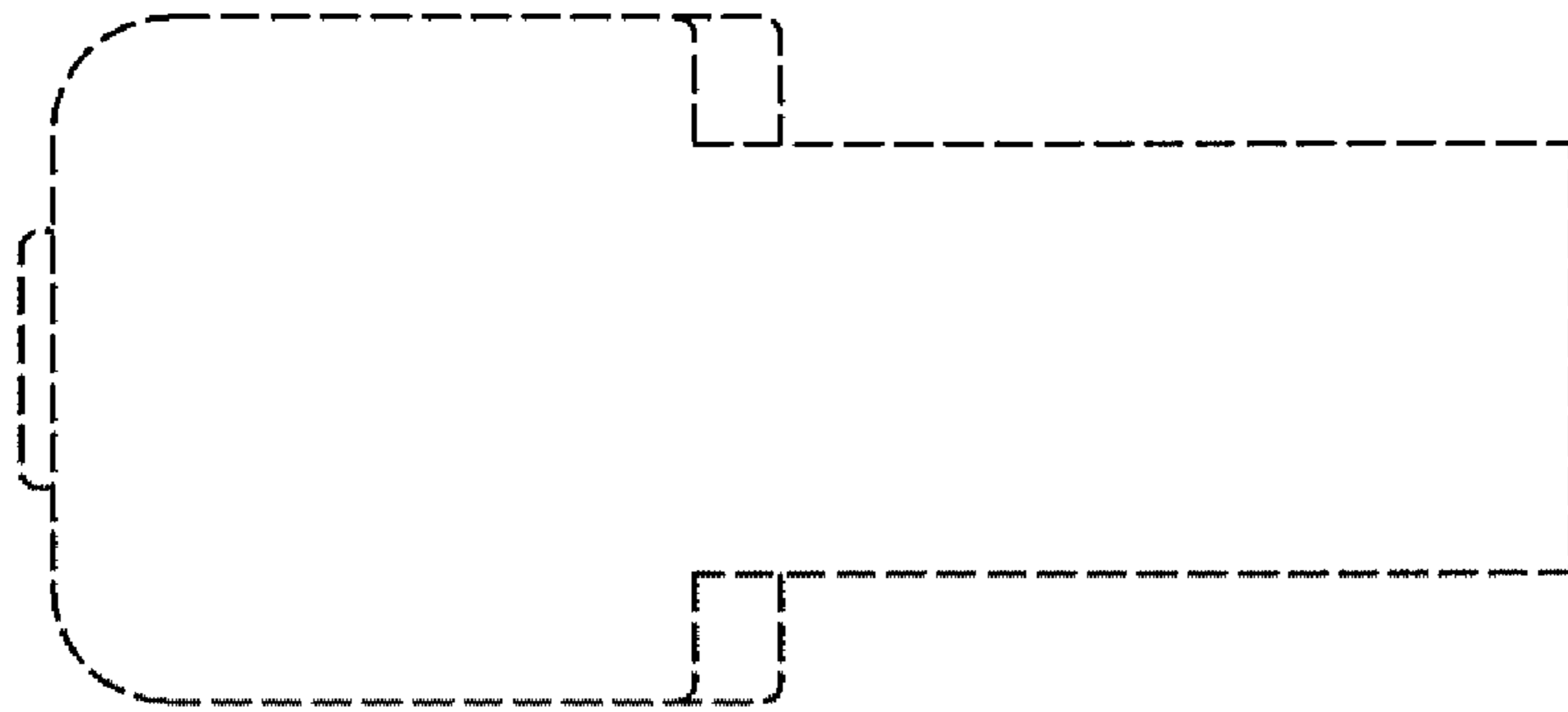

FIG.5

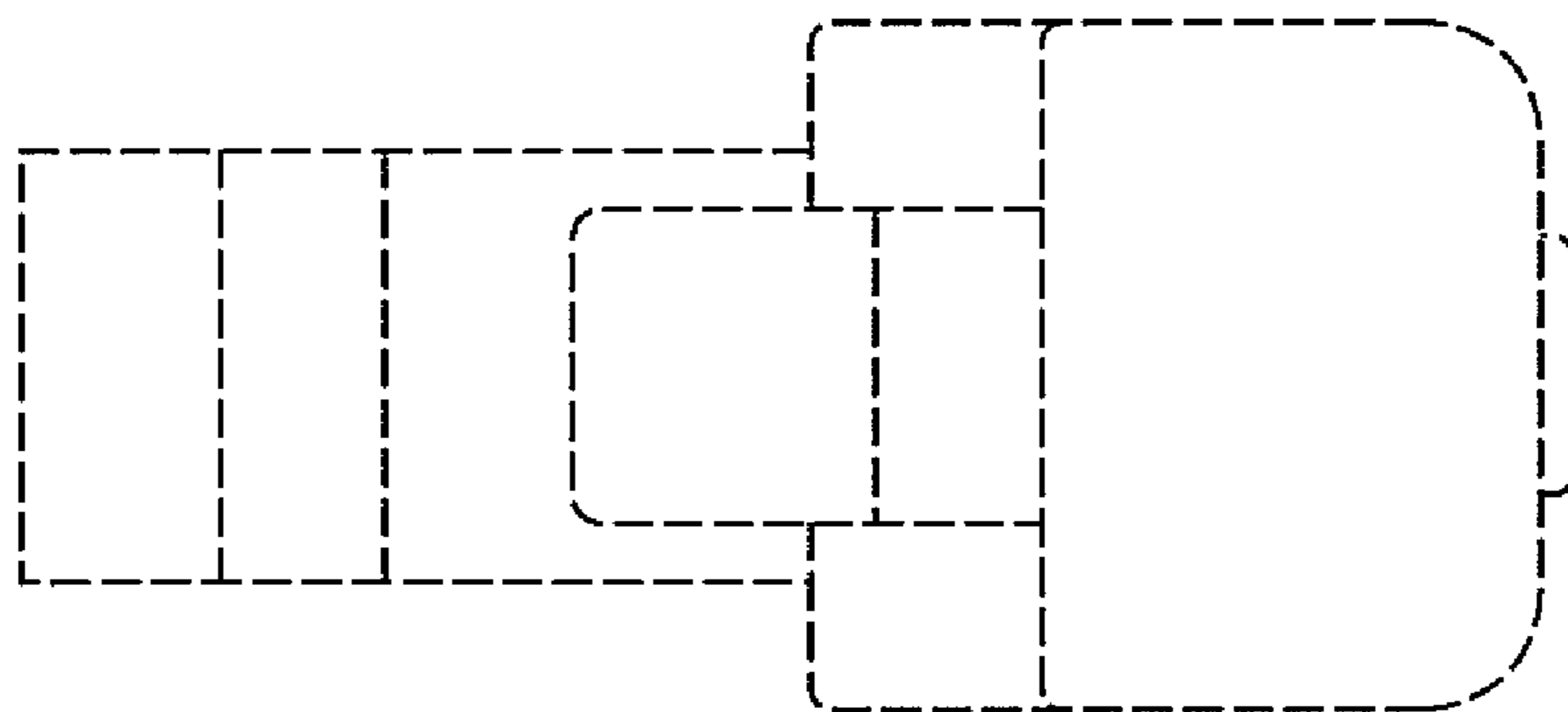

FIG.6

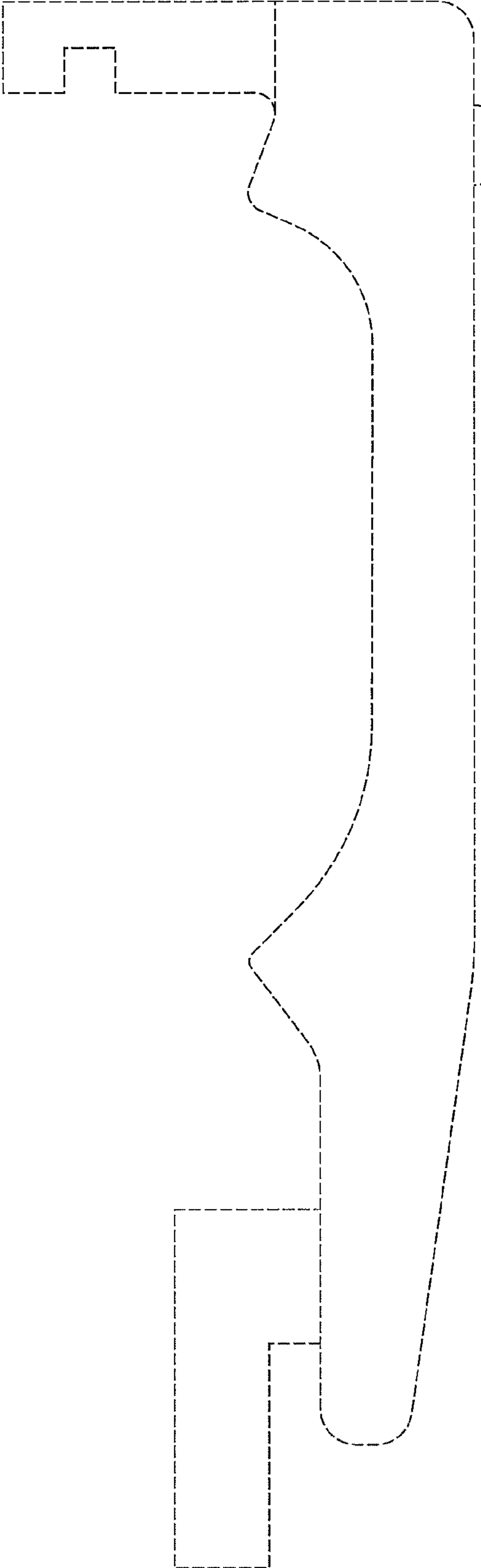

FIG.7

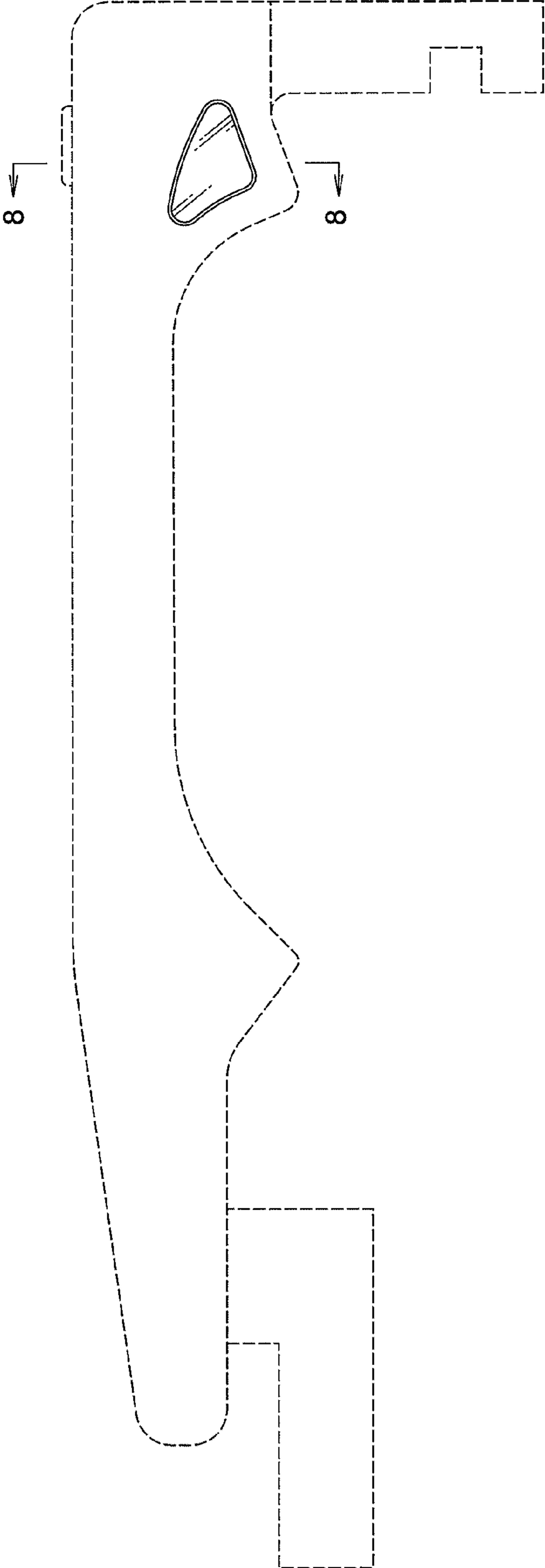

FIG.8

