



US00D638617S

(12) **United States Design Patent**
Casadei

(10) **Patent No.:** **US D638,617 S**

(45) **Date of Patent:** **** May 31, 2011**

(54) **HEEL FOR FOOTWEAR**

(75) Inventor: **Cesare Casadei**, Rimini (IT)

(73) Assignee: **Calzaturificio Casadei S.p.A.**, San Mauro Pascoli (IT)

(**) Term: **14 Years**

(21) Appl. No.: **29/384,475**

(22) Filed: **Jan. 31, 2011**

(30) **Foreign Application Priority Data**

Jan. 13, 2010 (EM) 001189310
Apr. 19, 2010 (EM) 001696857

(51) **LOC (9) Cl.** **02-99**

(52) **U.S. Cl.** **D2/965; D2/964**

(58) **Field of Classification Search** D2/915,
D2/925-942, 946, 964-966; 36/34 R-34 B,
36/105

See application file for complete search history.

(56) **References Cited**

U.S. PATENT DOCUMENTS

D11,152 S * 4/1879 Jones D2/965
1,922,058 A * 8/1933 Miller et al. D2/966

D95,767 S * 5/1935 Marks D2/965
D111,852 S * 10/1938 Hurzeler D2/965
D113,018 S * 1/1939 Schwartz D2/965
D122,607 S * 9/1940 Nutt D2/965
D127,528 S * 5/1941 Terpak D2/966
D129,576 S * 9/1941 Ausubel D2/966
D129,577 S * 9/1941 Ausubel D2/966

* cited by examiner

Primary Examiner — Dominic Simone

(74) *Attorney, Agent, or Firm* — Pearne & Gordon LLP

(57) **CLAIM**

The ornamental design for a heel for footwear, as shown and described.

DESCRIPTION

FIG. 1 is a front view of a heel for footwear, showing my new design;
FIG. 2 is a rear view thereof;
FIG. 3 is a right side view thereof;
FIG. 4 is a left side view thereof;
FIG. 5 is a top plan view thereof;
FIG. 6 is a bottom plan view thereof; and,
FIG. 7 is a front-right perspective view thereof.

1 Claim, 7 Drawing Sheets

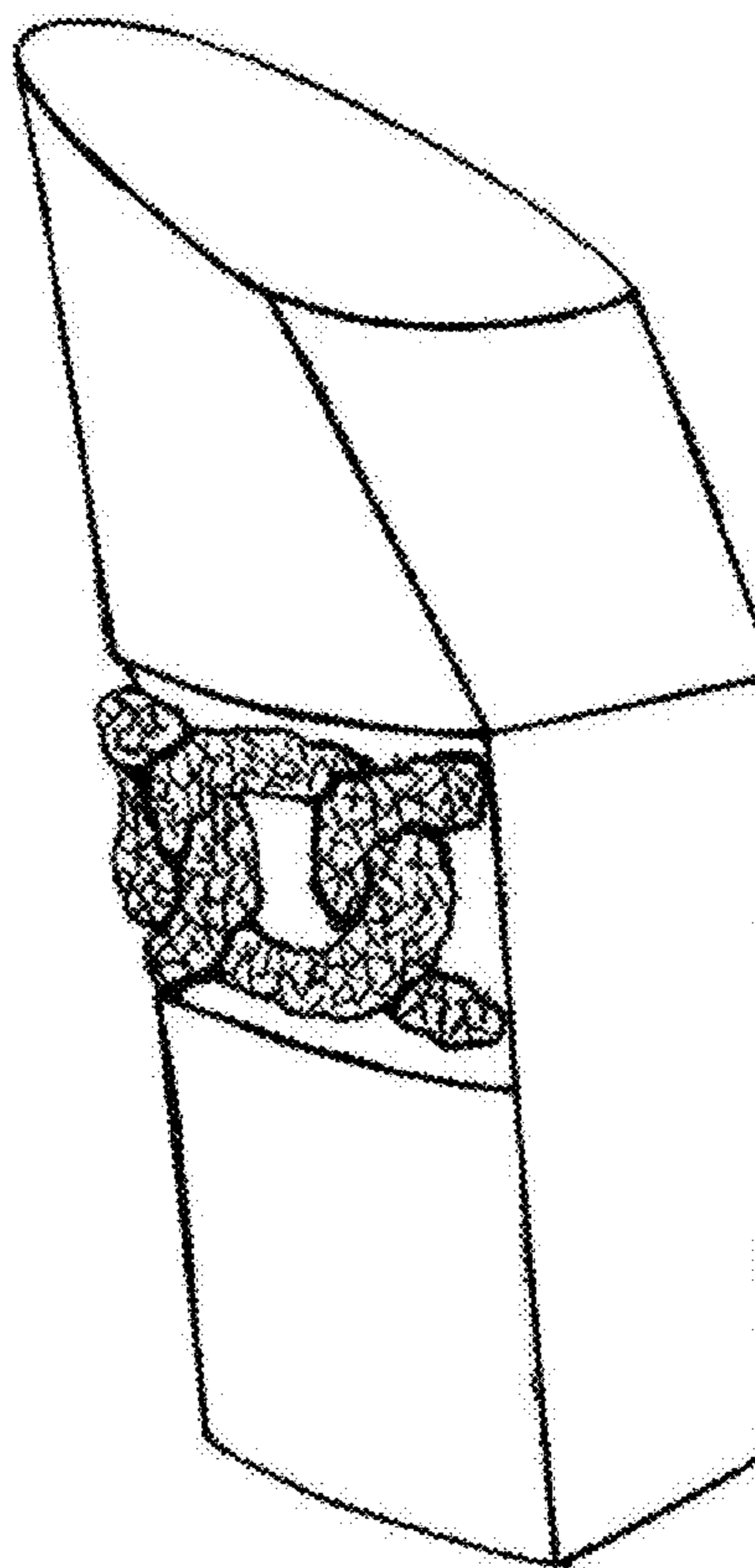
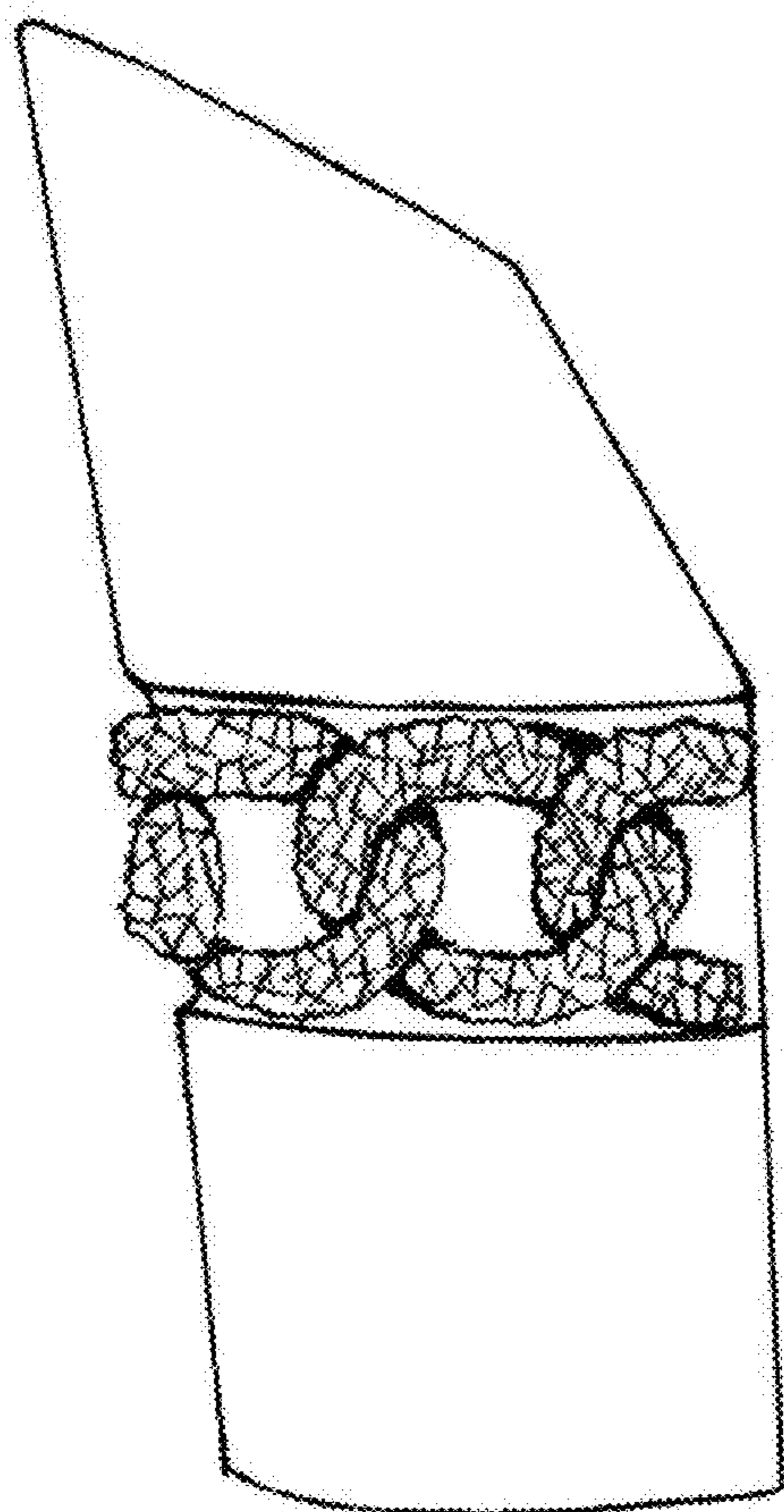
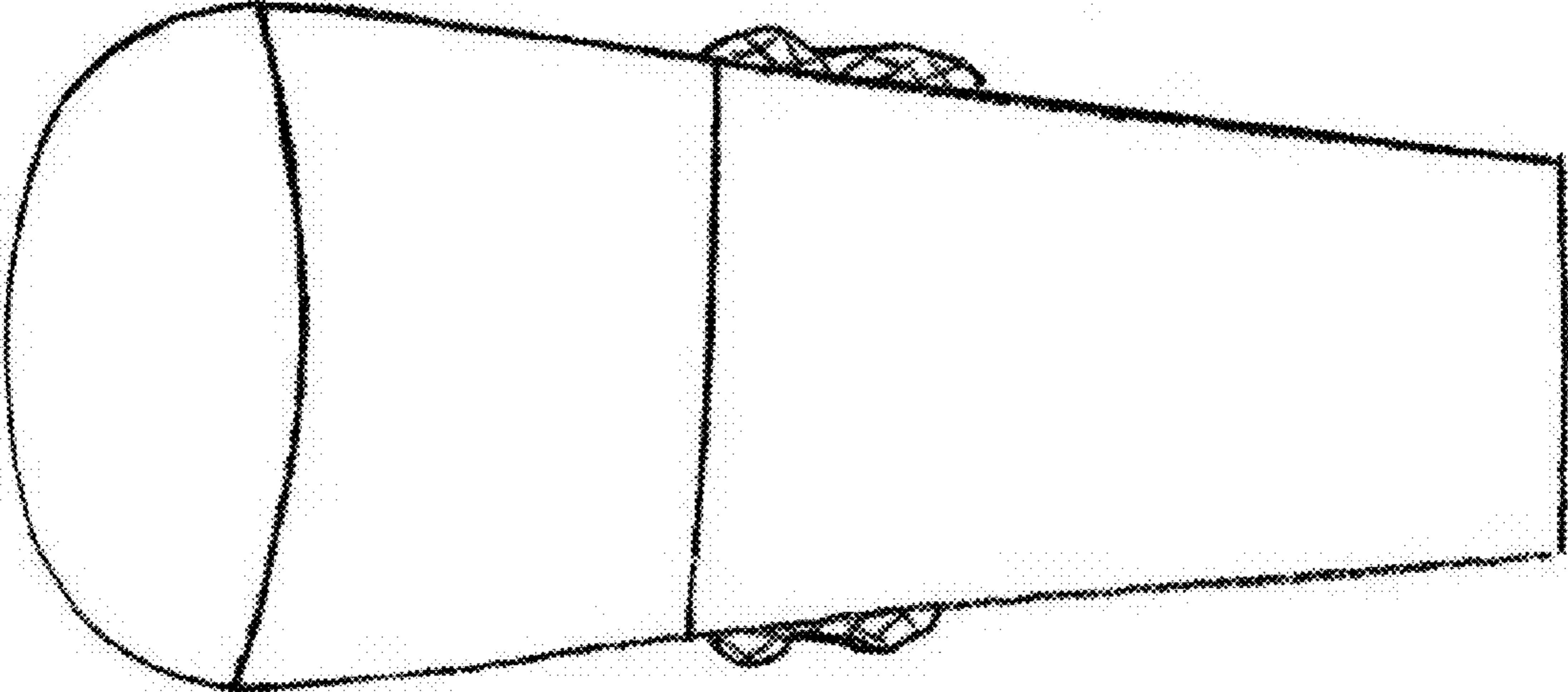

FIG. 1



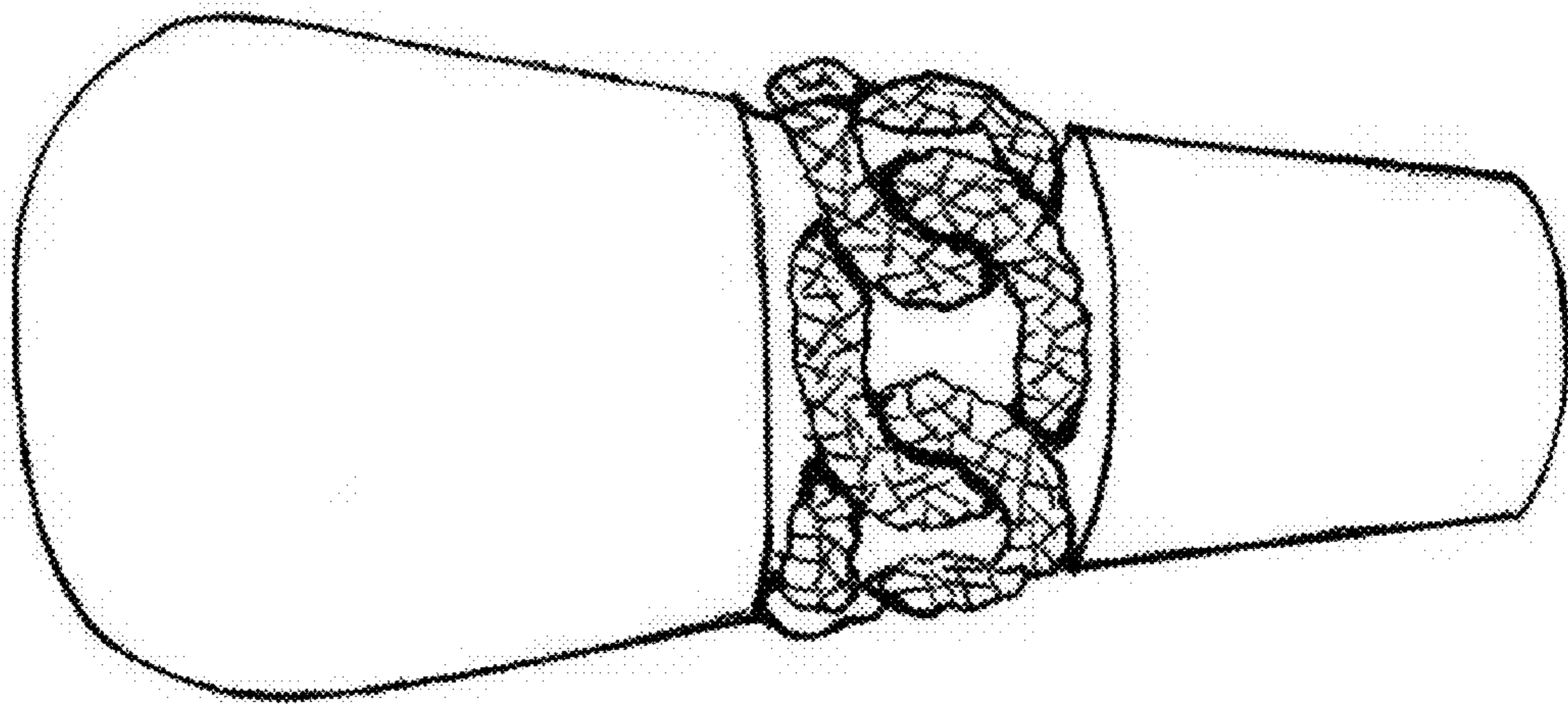

FIG. 2

FIG. 3

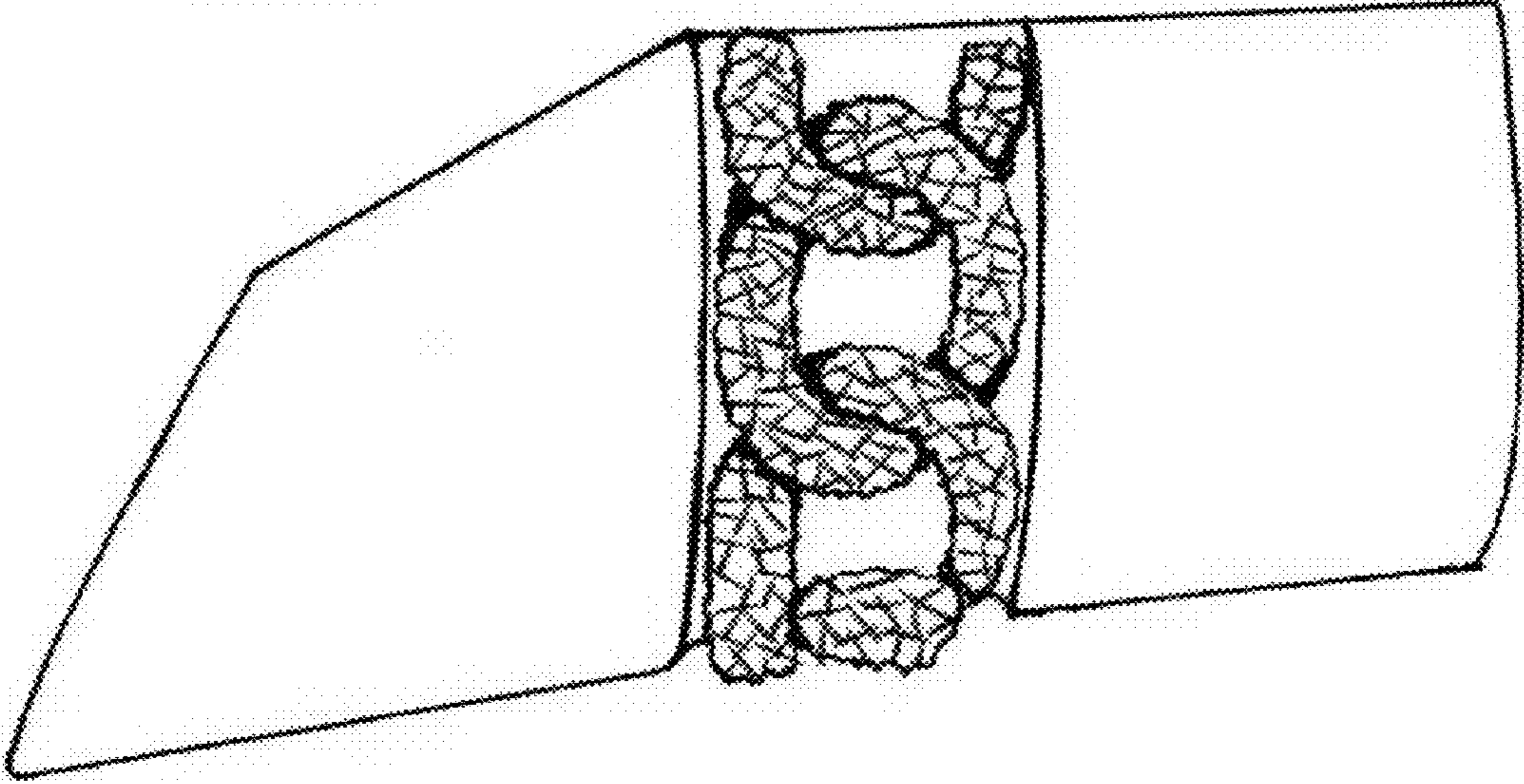

FIG. 4

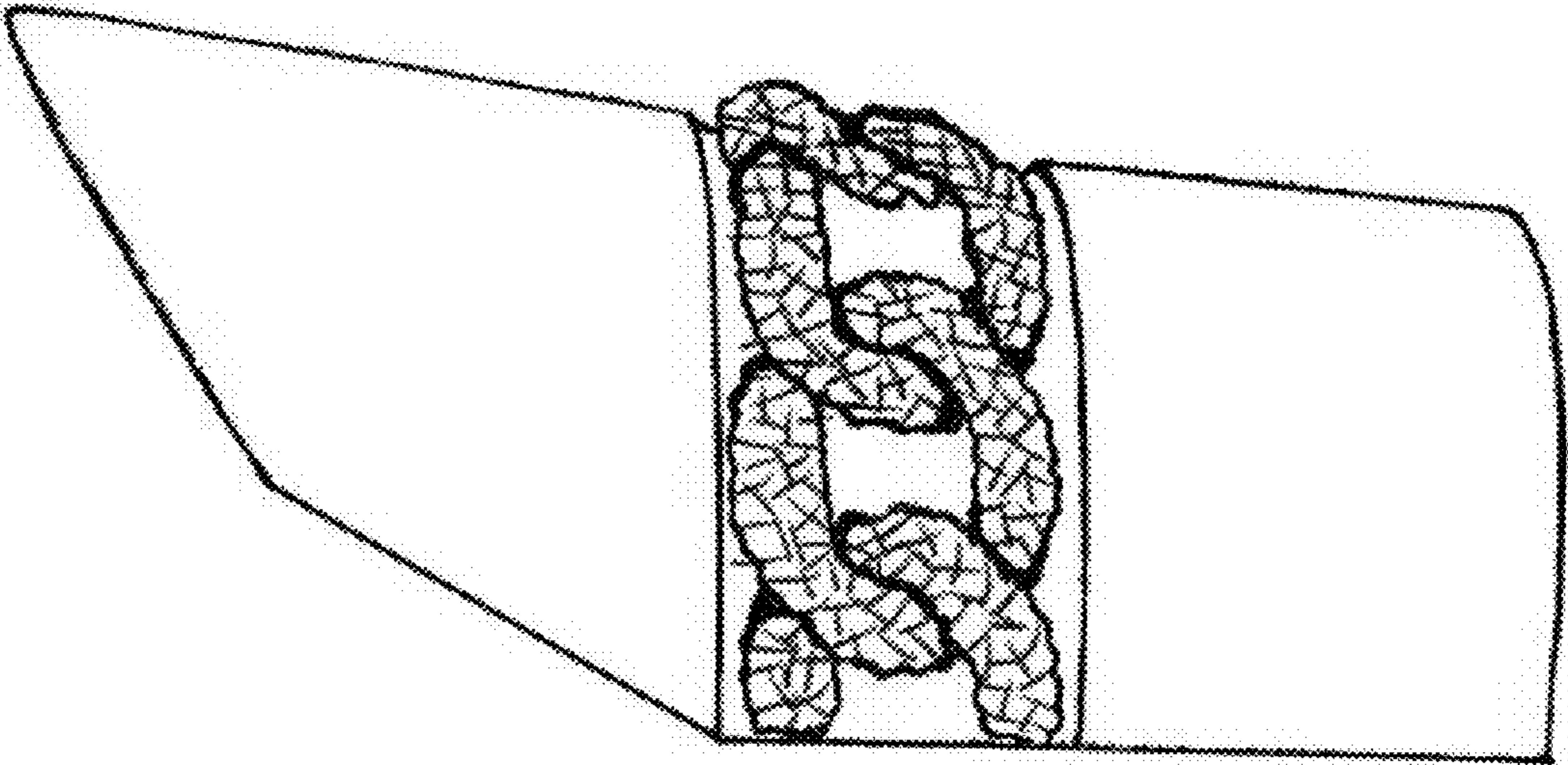

FIG. 5

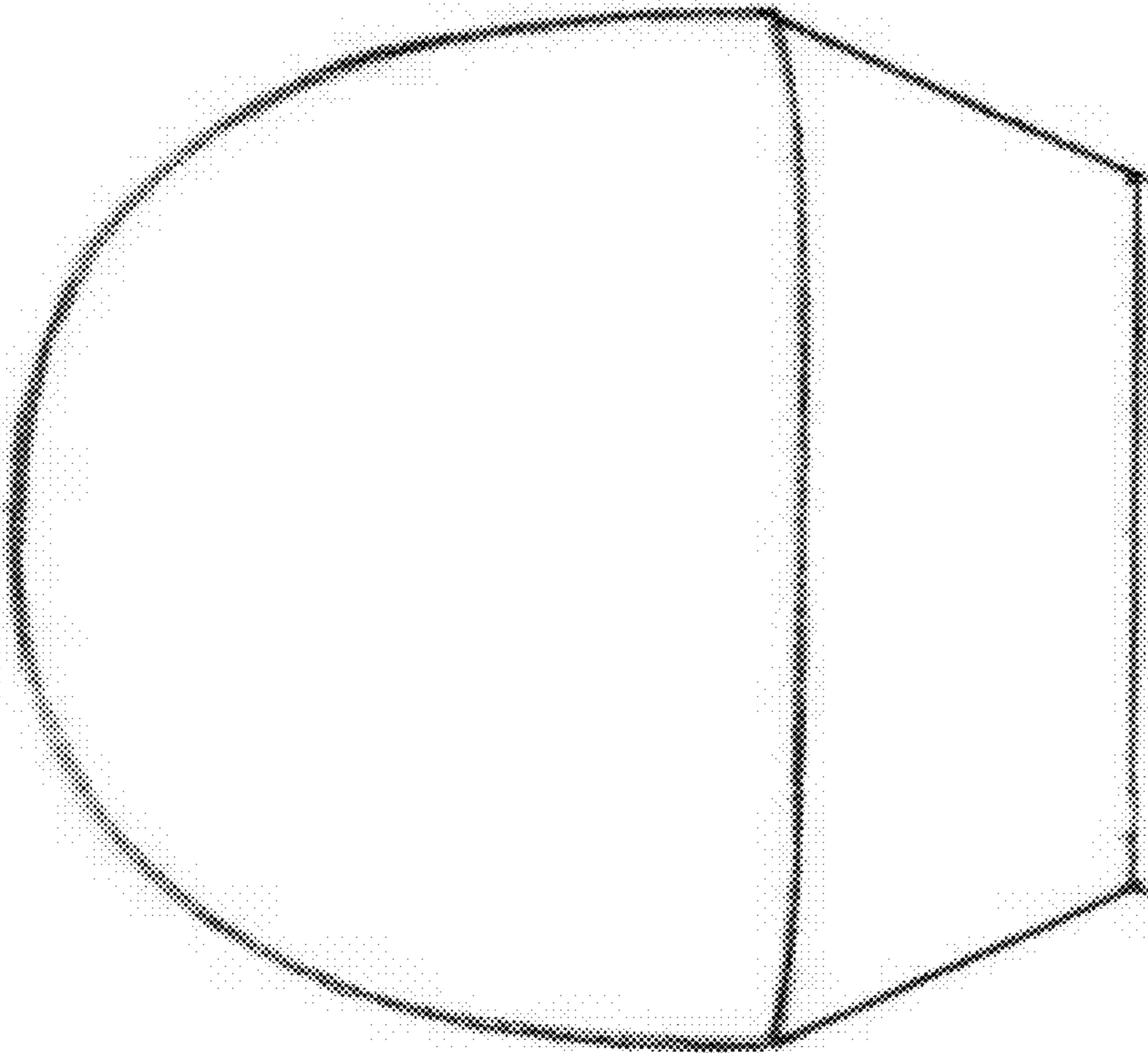
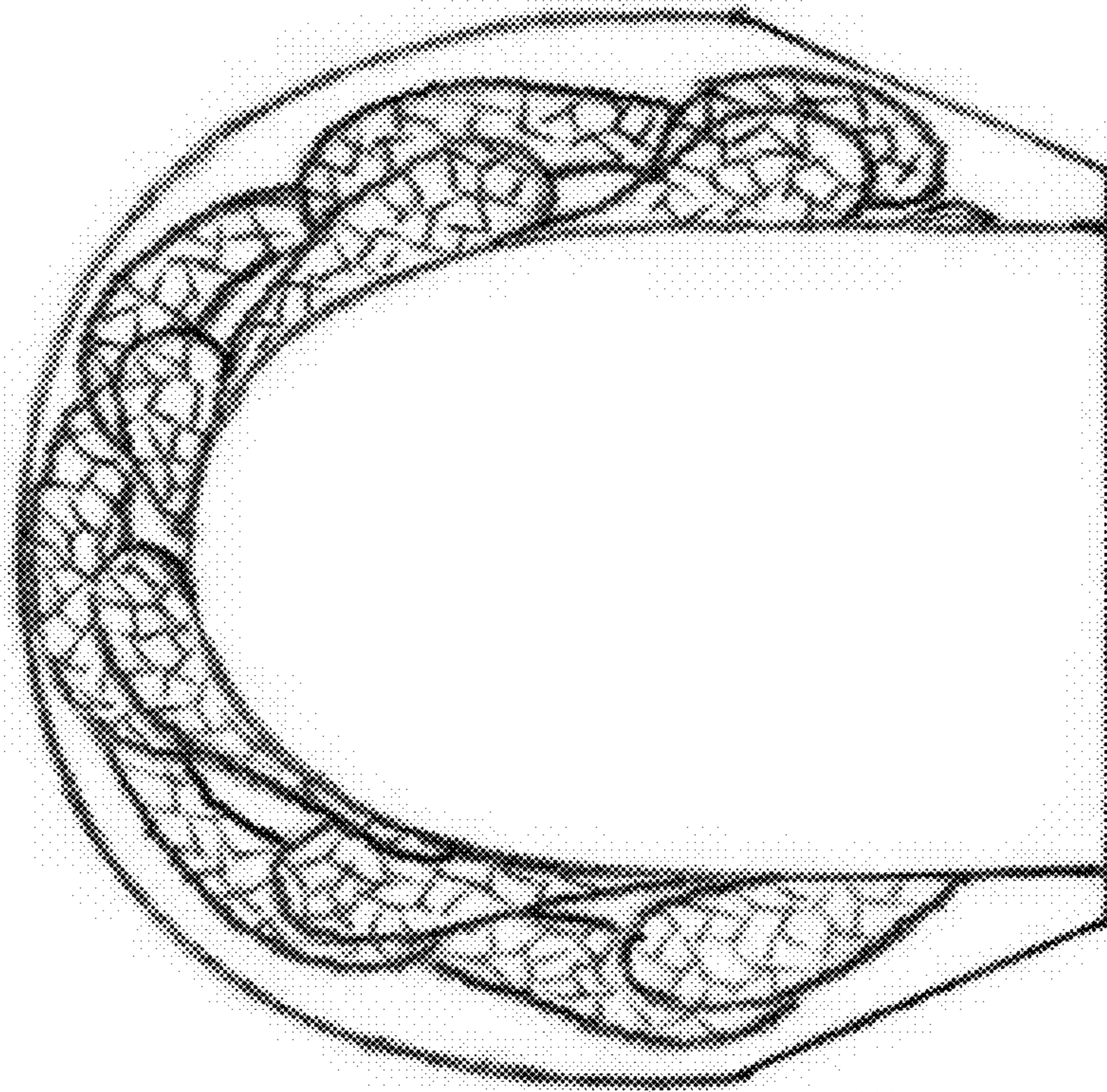

FIG. 6



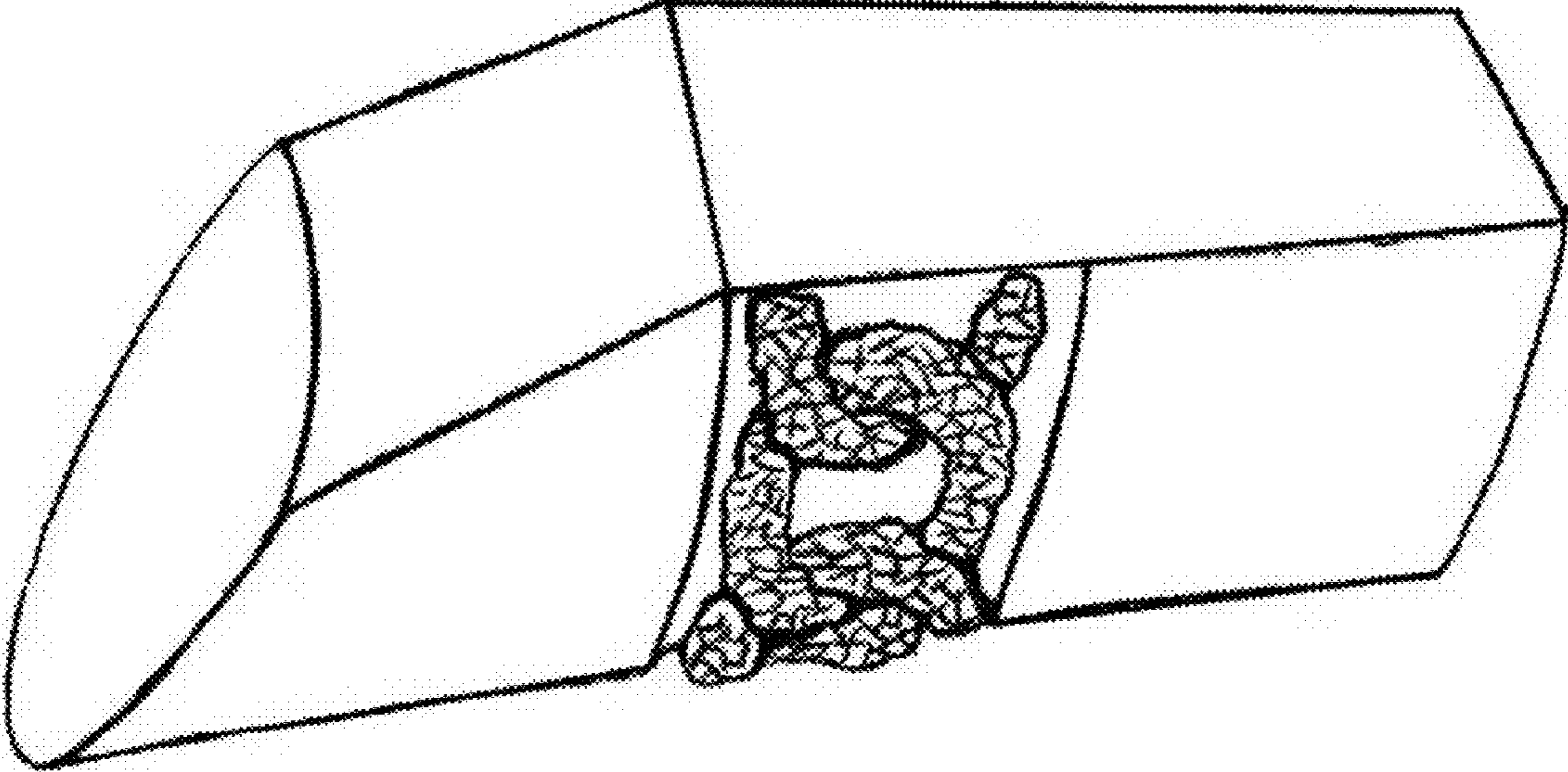

FIG. 7