



US00D638609S

(12) **United States Design Patent**
Gosse

(10) **Patent No.:** **US D638,609 S**

(45) **Date of Patent:** **** May 31, 2011**

(54) **PANTS**

(75) Inventor: **Andrew Gosse**, West Linn, OR (US)

(73) Assignee: **Columbia Sportswear North America, Inc.**, Portland, OR (US)

(**) Term: **14 Years**

(21) Appl. No.: **29/377,401**

(22) Filed: **Oct. 20, 2010**

(51) **LOC (9) Cl.** **02-02**

(52) **U.S. Cl.** **D2/742; D2/853**

(58) **Field of Classification Search** D2/700,
D2/731, 738, 742, 712; 2/78.1, 79, 80, 227,
2/228, 234–238, 400, 406, 407; D24/190
See application file for complete search history.

(56) **References Cited**

U.S. PATENT DOCUMENTS

D86,113	S	*	2/1932	Dwyer	D2/738
3,920,008	A	*	11/1975	Lehman	128/96.1
D292,340	S	*	10/1987	Sjoholm	D2/742
5,105,473	A	*	4/1992	Valtakari	2/461
5,351,340	A	*	10/1994	Aldridge	2/108
D366,555	S	*	1/1996	Daniels	D29/101.5
5,551,084	A	*	9/1996	Freese, III	2/23
5,820,575	A	*	10/1998	Cabrera et al.	602/19
5,926,856	A	*	7/1999	Duval	2/455
D418,948	S	*	1/2000	London	D29/101.1
6,108,819	A	*	8/2000	DeBaene et al.	2/227
7,523,508	B2	*	4/2009	Contant et al.	2/227

FOREIGN PATENT DOCUMENTS

JP 2001248005 A * 9/2001

* cited by examiner

Primary Examiner — Ian Simmons

Assistant Examiner — Rashida Johnson

(74) *Attorney, Agent, or Firm* — Schwabe, Williamson & Wyatt, P.C.

(57) **CLAIM**

I claim an ornamental design for pants, as shown and described.

DESCRIPTION

FIG. 1 is a front perspective view of pants showing my new design; the flap folded down;

FIG. 2 is a rear view of the pants illustrated in FIG. 1 with the flap folded down;

FIG. 3 is a front view of the pants illustrated in FIG. 1 with the flap folded down;

FIG. 4 is a right side view of the pants illustrated in FIG. 1 with the flap folded down;

FIG. 5 is a left side view of the pants illustrated in FIG. 1 with the flap folded down;

FIG. 6 is a front perspective view of the pants illustrated in FIG. 1, showing the flap folded up;

FIG. 7 is a rear view of the pants illustrated in FIG. 6 with the flap folded up;

FIG. 8 is a front view of the pants illustrated in FIG. 6 with the flap folded up;

FIG. 9 is a right side view of the pants illustrated in FIG. 6 with the flap folded up;

FIG. 10 is a left side view of the pants illustrated in FIG. 6 with the flap folded up;

FIG. 11 is a top view of the pants illustrated in FIG. 1 with the flap folded down;

FIG. 12 is a bottom view of the pants illustrated in FIG. 1 with the flap folded down;

FIG. 13 is a top view of the pants illustrated in FIG. 6 with the flap folded up; and,

FIG. 14 is a bottom view of the pants illustrated if FIG. 6 with the flap folded up.

The broken lines in FIGS. 1-14 represent the portions of the pants, which form no part of the claimed design.

1 Claim, 9 Drawing Sheets

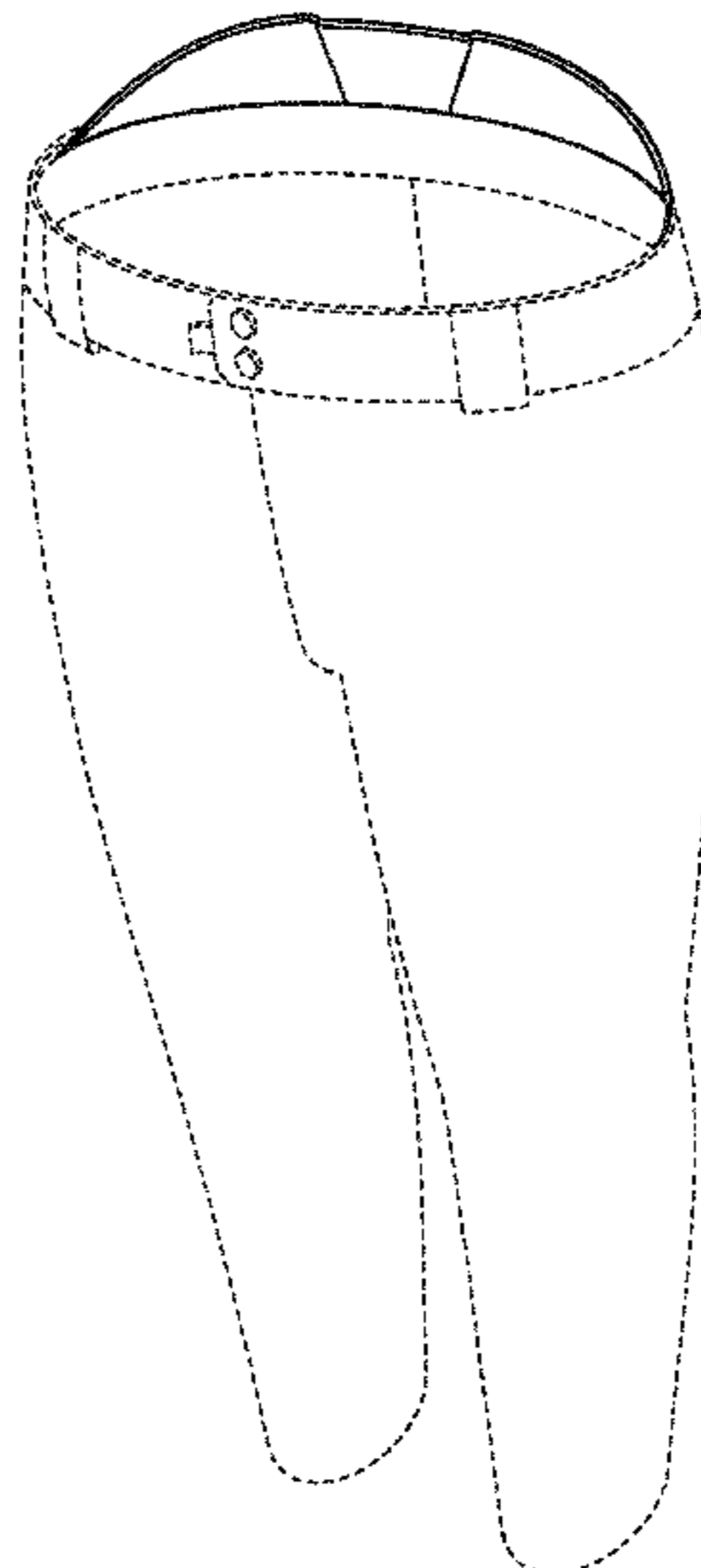
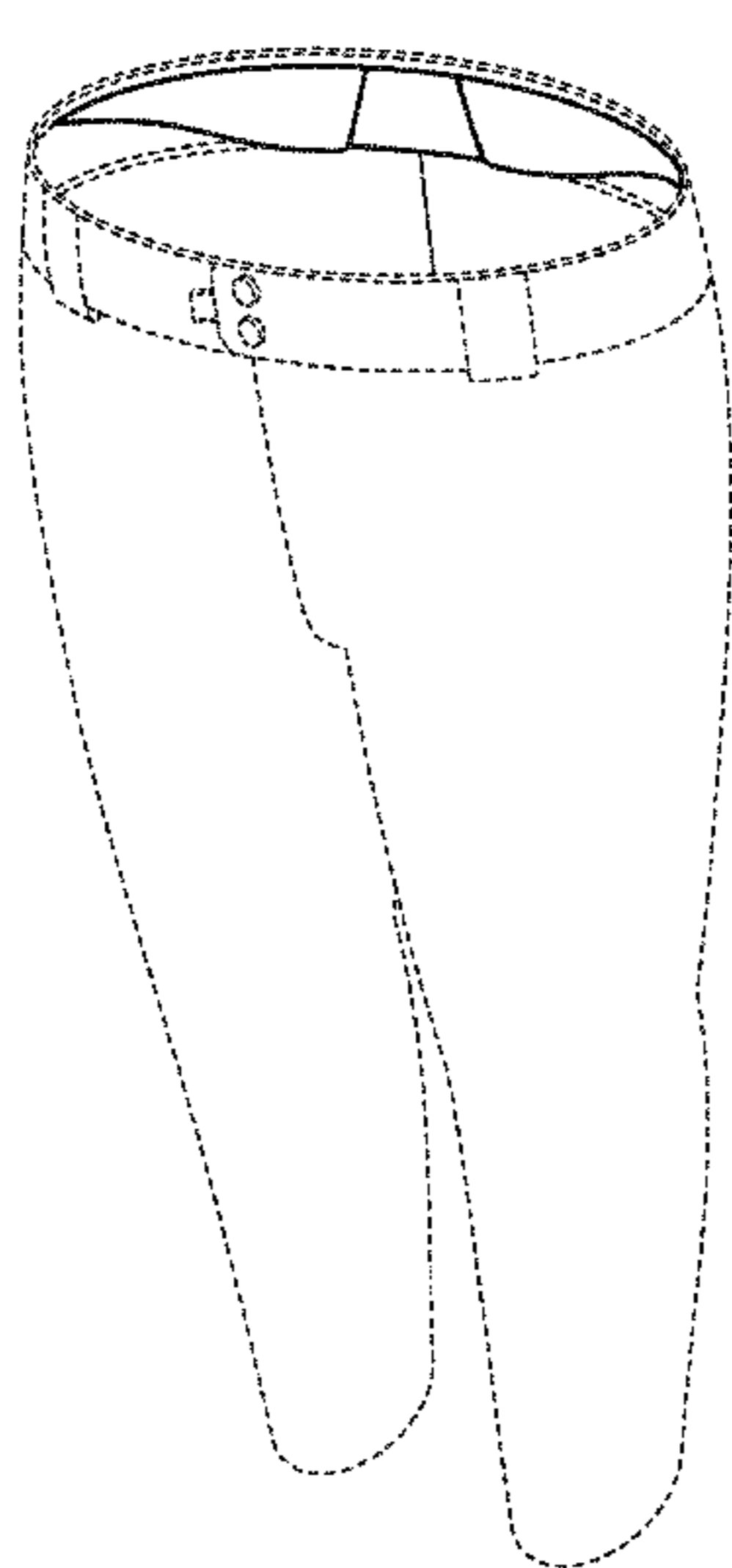
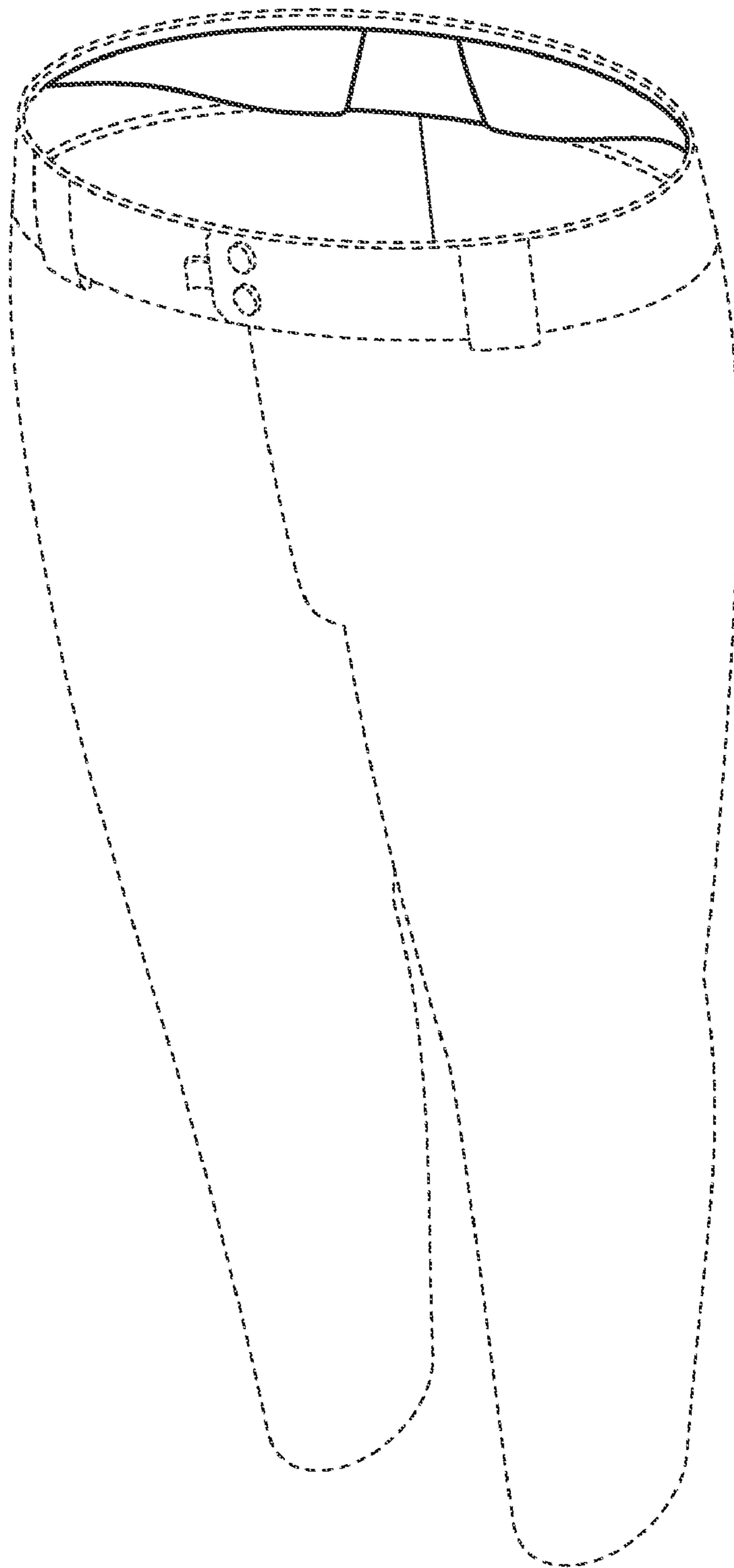

FIG. 1



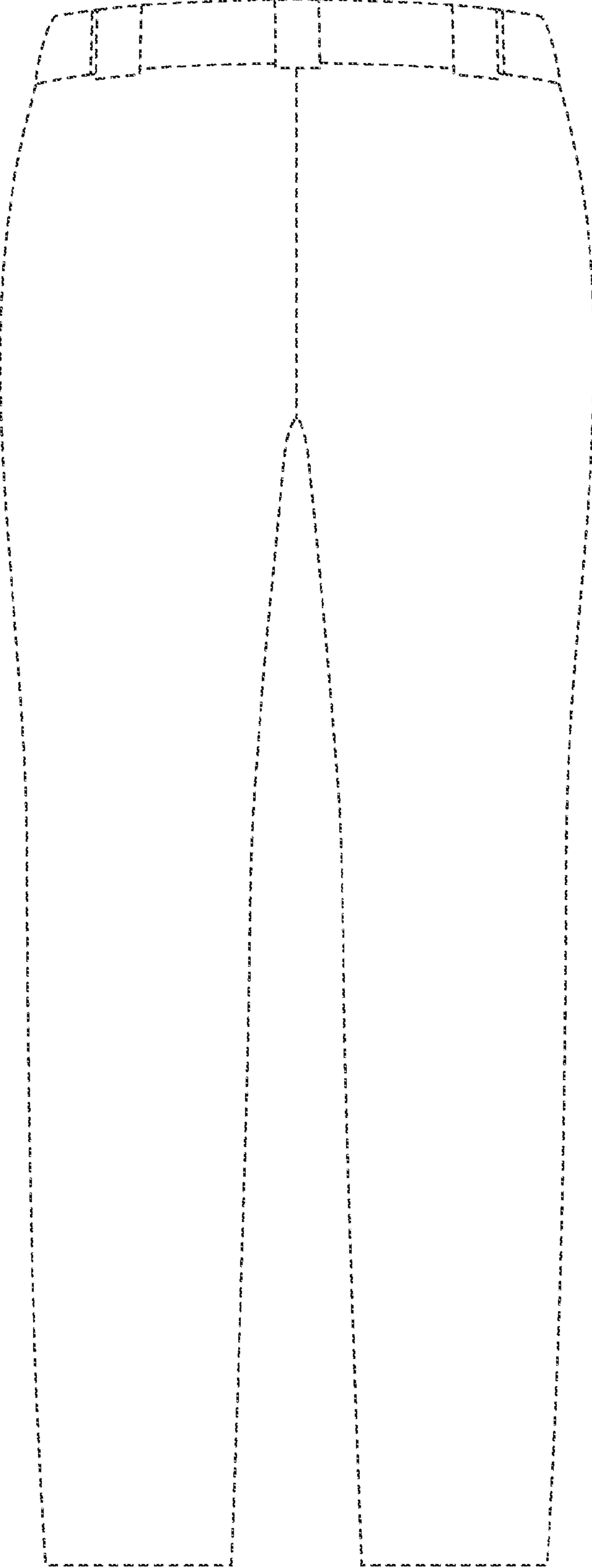

FIG. 2

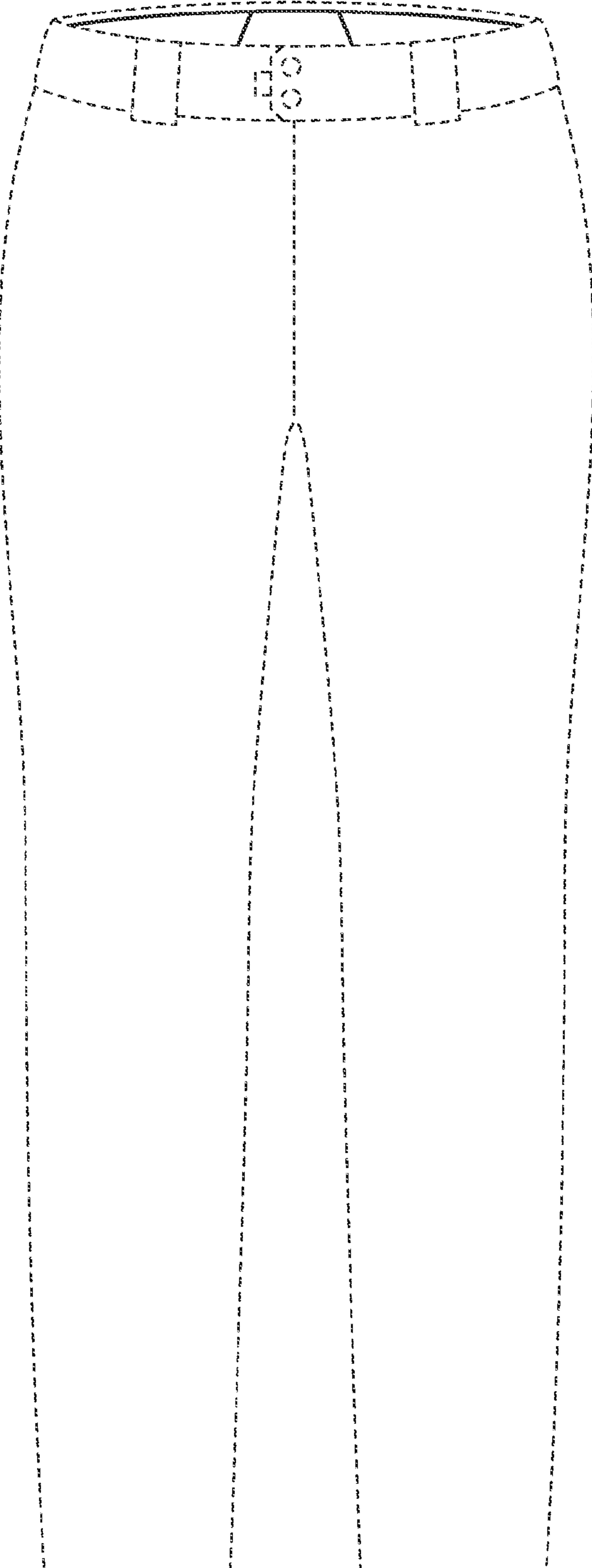

FIG. 3

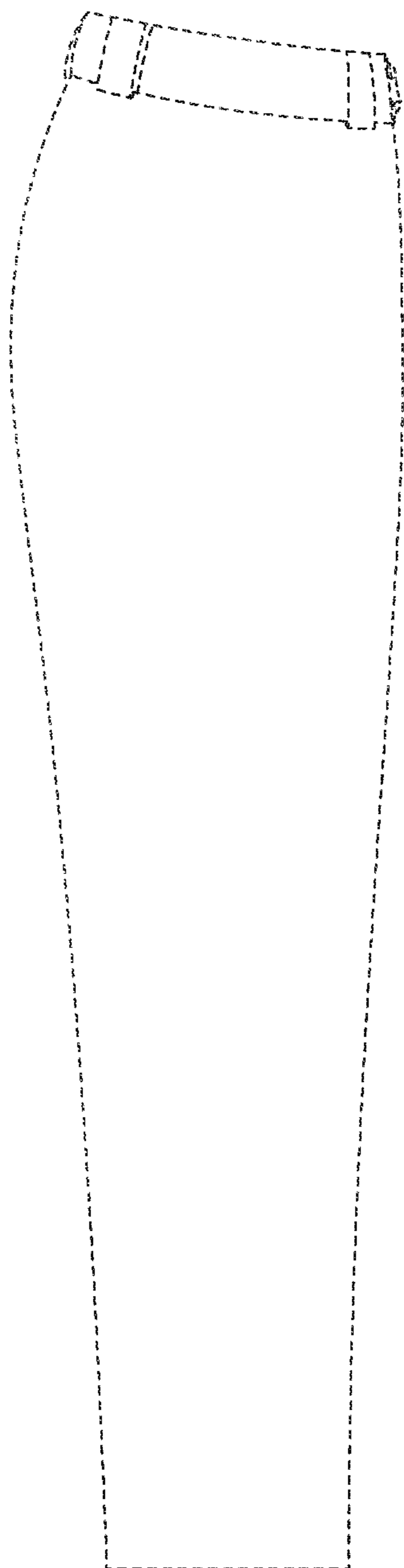

FIG. 4

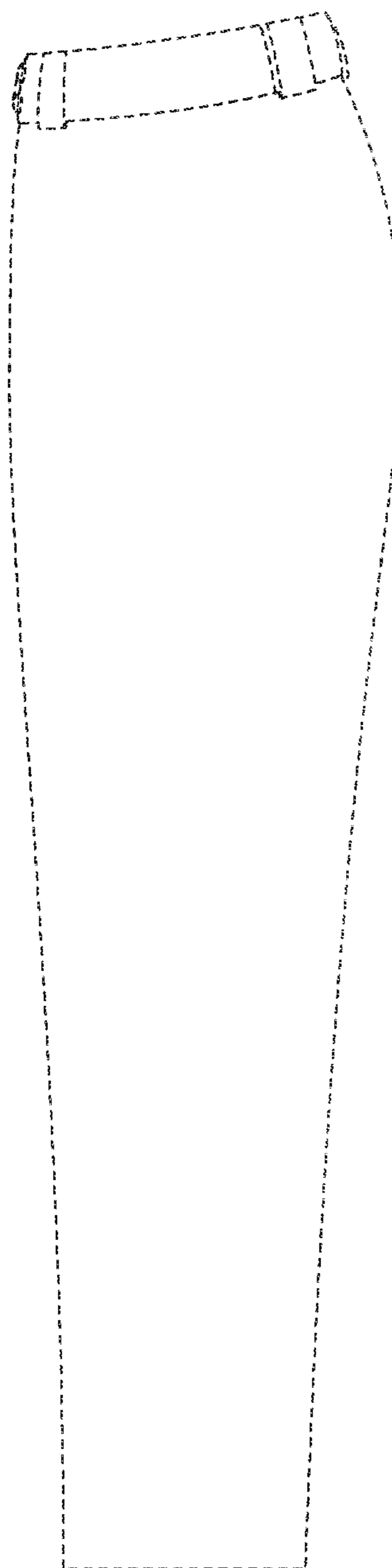
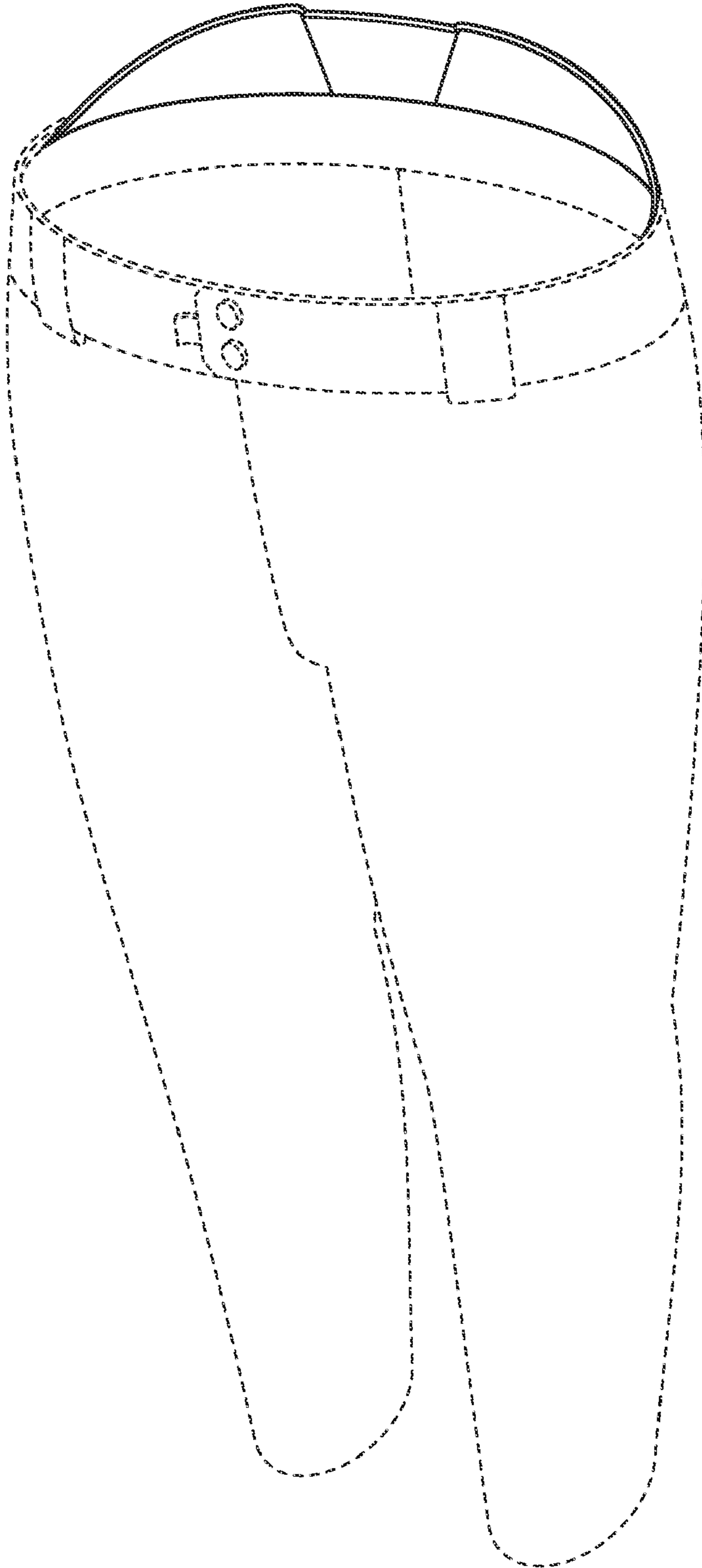

FIG. 5

FIG. 6



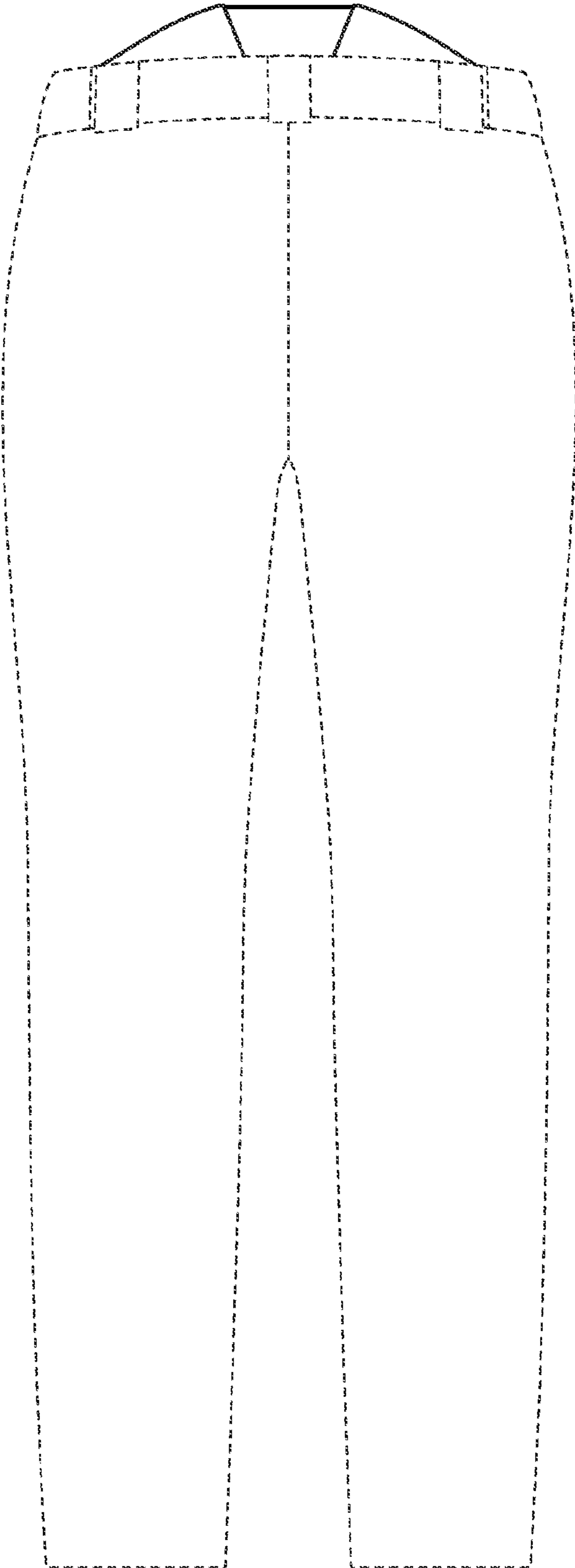

FIG. 7

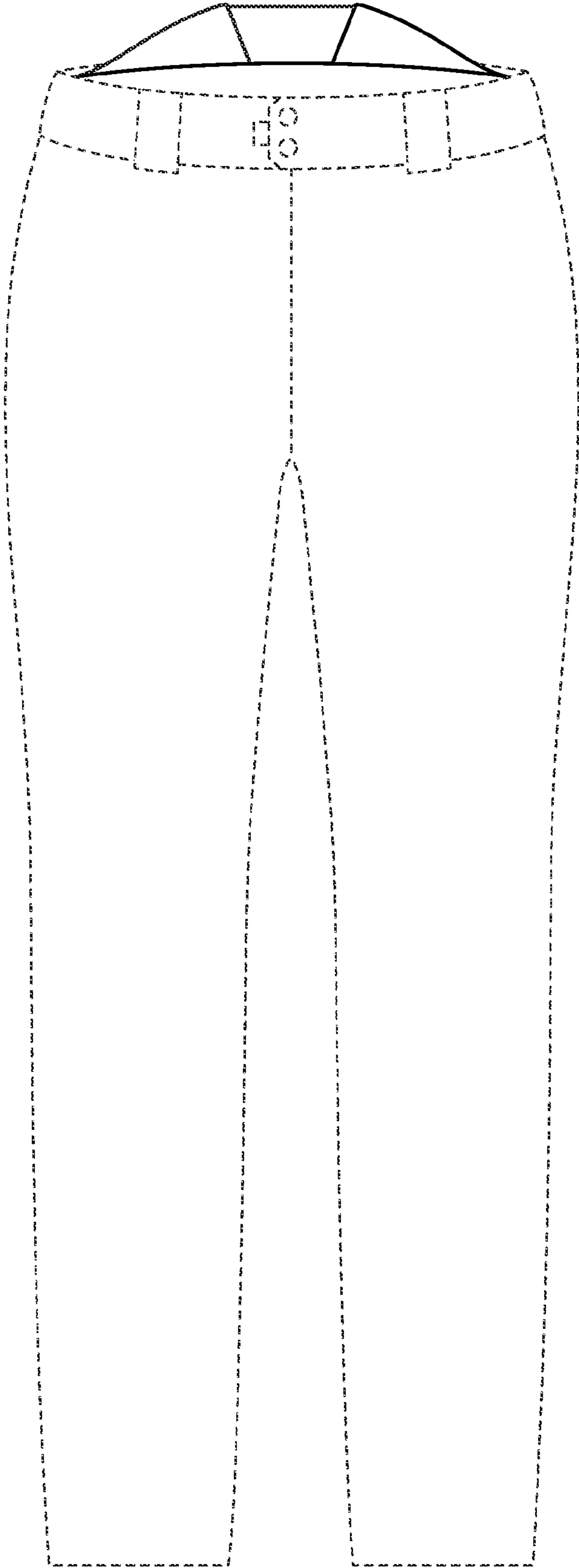

FIG. 8

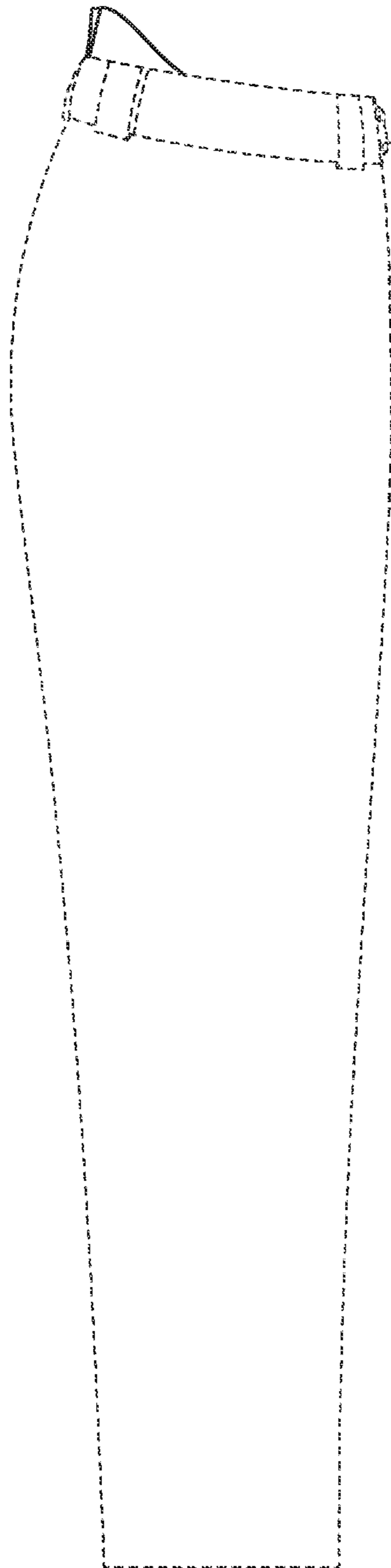

FIG. 9

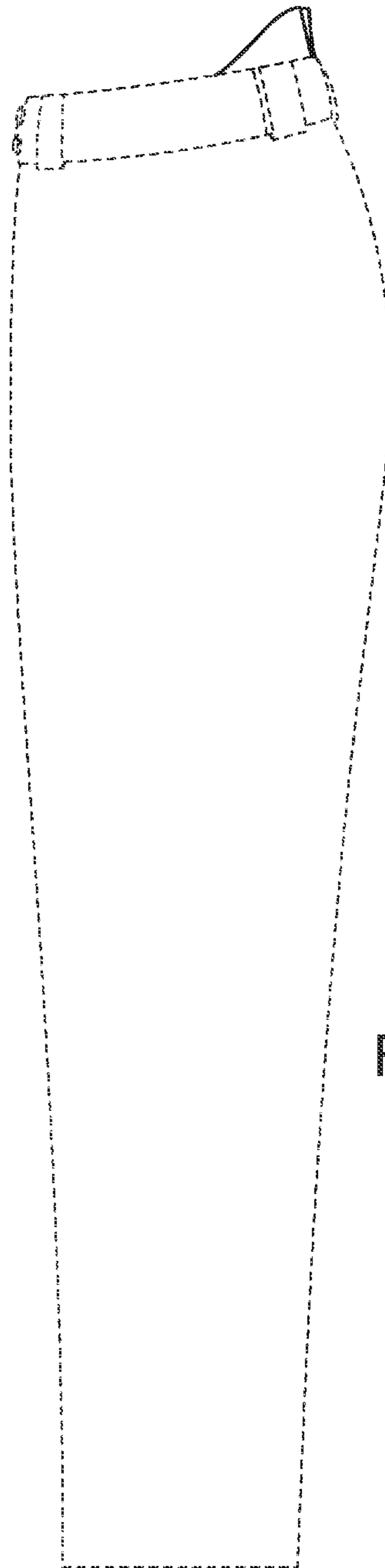

FIG. 10

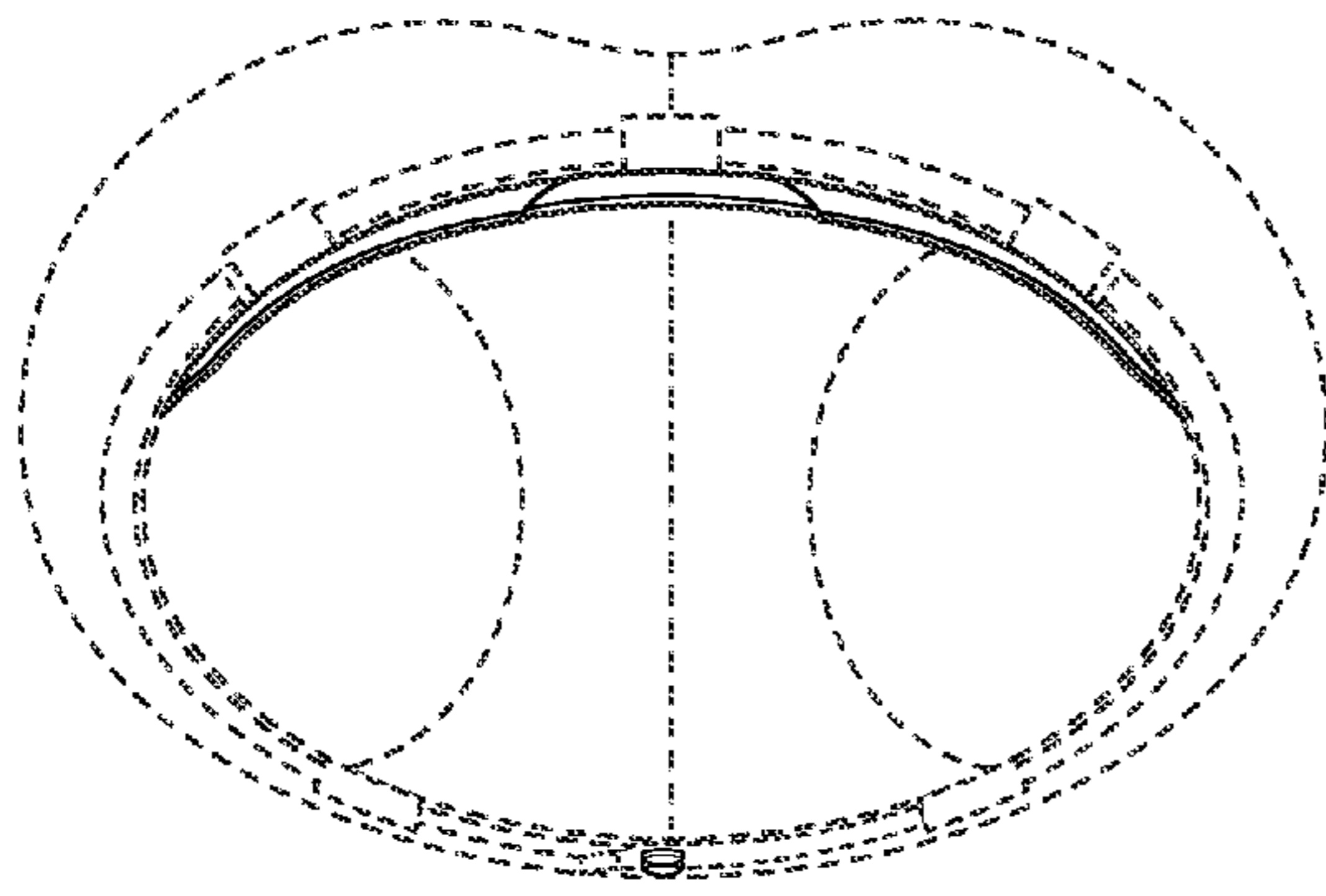

FIG. 11

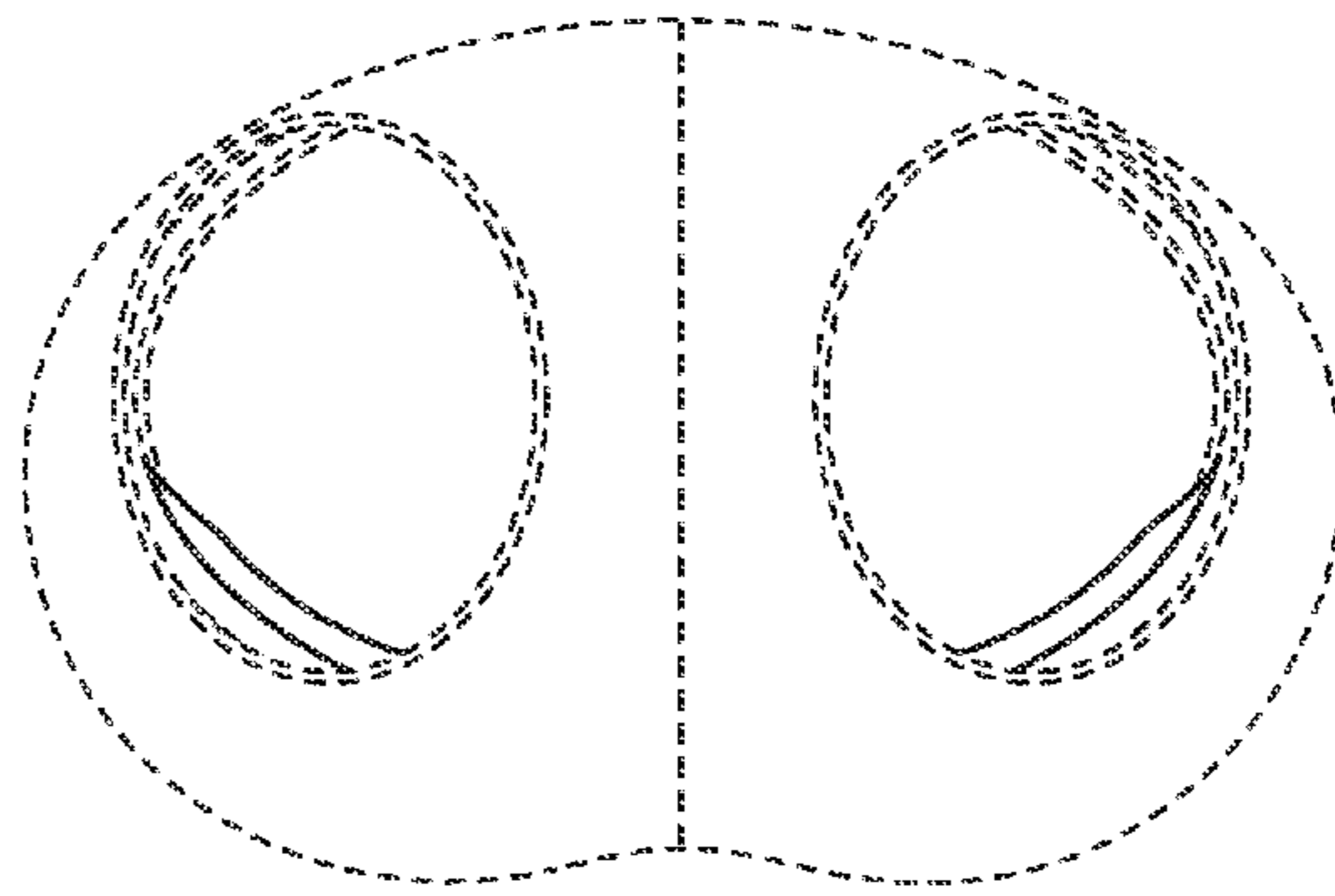

FIG. 12

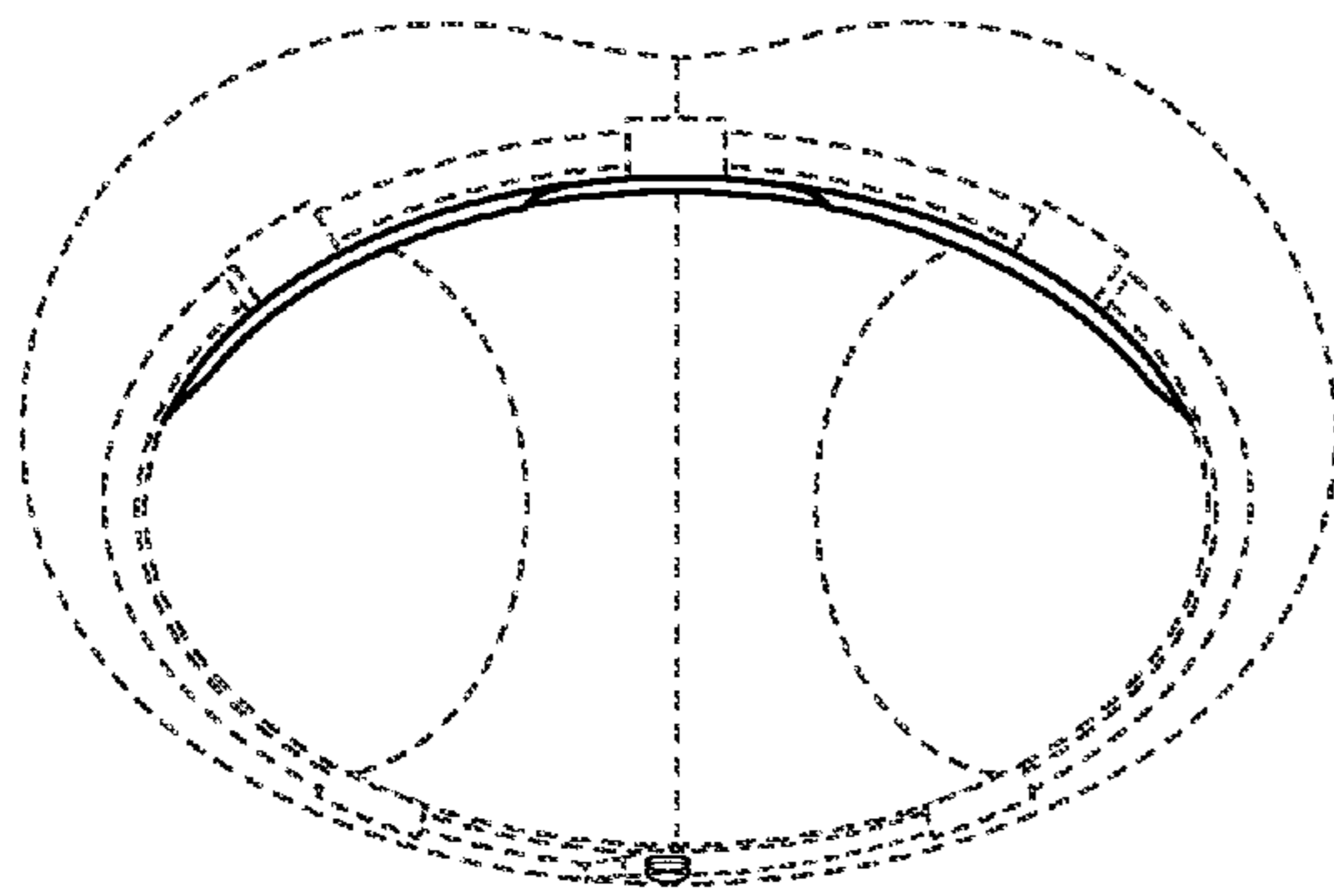

FIG. 13

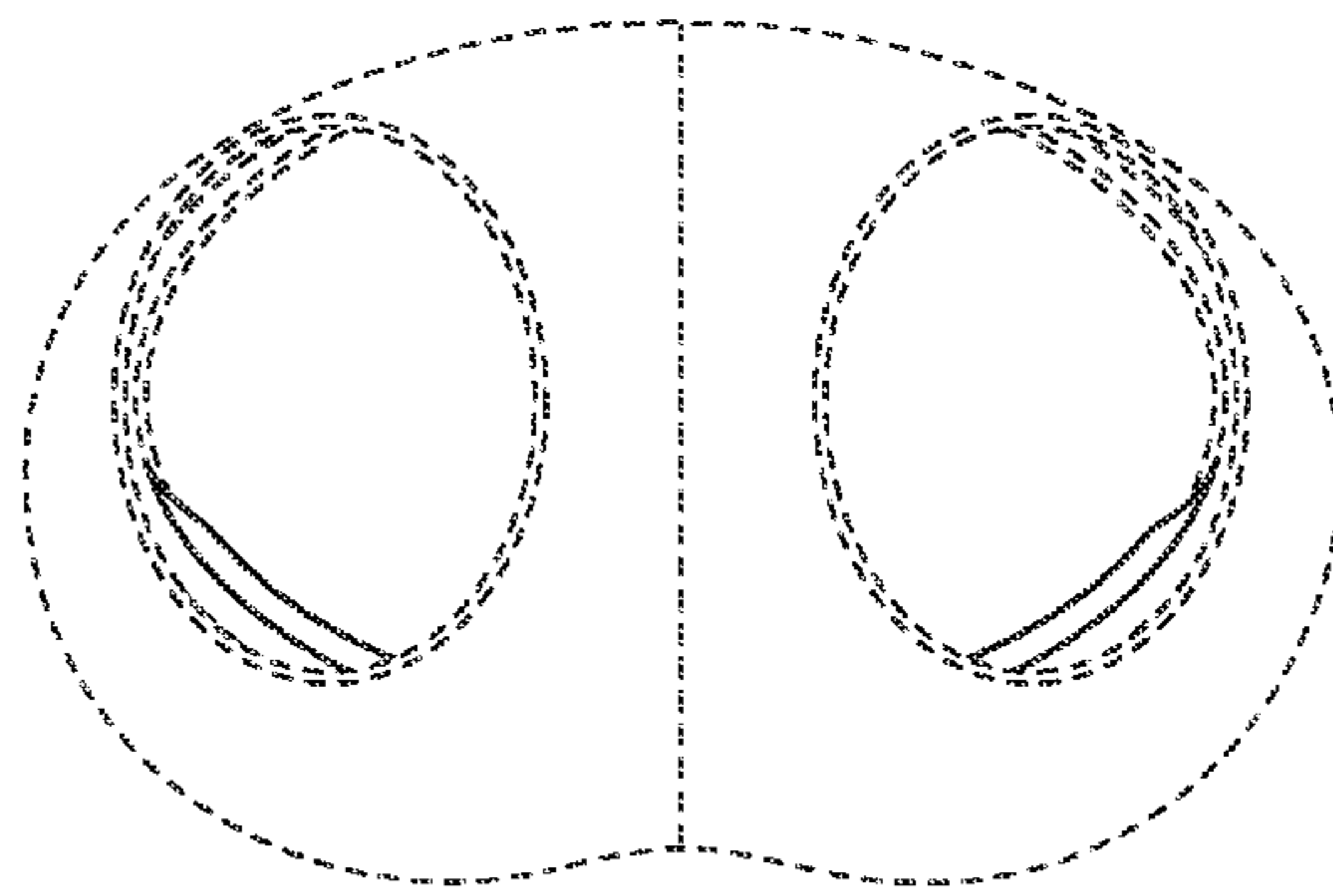

FIG. 14