



US00D638580S

(12) **United States Design Patent**  
**Adams et al.**

(10) **Patent No.:** **US D638,580 S**

(45) **Date of Patent:** **\*\* May 24, 2011**

(54) **SHAVING RAZOR**

(75) Inventors: **Isabelle Jane Adams**, Reading (GB);  
**Terence Gordon Royle**, Basingstoke  
(GB)

(73) Assignee: **The Gillette Company**, Boston, MA  
(US)

(\*\*) Term: **14 Years**

(21) Appl. No.: **29/380,578**

(22) Filed: **Dec. 8, 2010**

**Related U.S. Application Data**

(62) Division of application No. 29/345,344, filed on Oct.  
14, 2009, now Pat. No. Des. 631,198.

(51) **LOC (9) Cl.** ..... **28-03**

(52) **U.S. Cl.** ..... **D28/46**

(58) **Field of Classification Search** ..... D28/44-48;  
30/32, 34.05, 34.1-34.2, 41, 44-46, 47-51,  
30/57-58, 77-84, 526-539, 346.5-346.61  
See application file for complete search history.

(56) **References Cited**

**U.S. PATENT DOCUMENTS**

D416,108	S	*	11/1999	Shurtleff et al.	.....	D28/46
D524,984	S	*	7/2006	Ramm et al.	.....	D28/46
D533,964	S	*	12/2006	Ham	.....	D28/48
D536,830	S	*	2/2007	Ramm et al.	.....	D28/48
D547,494	S	*	7/2007	Watson et al.	.....	D28/47
D550,400	S	*	9/2007	Orloff et al.	.....	D28/47
D556,378	S	*	11/2007	Watson et al.	.....	D28/47
D559,452	S	*	1/2008	Padain et al.	.....	D28/46
D563,043	S	*	2/2008	Ramm	.....	D28/47
D563,044	S	*	2/2008	Ramm	.....	D28/47
D563,047	S	*	2/2008	Ramm et al.	.....	D28/48
D609,404	S	*	2/2010	Peyser et al.	.....	D28/47

D614,354	S	*	4/2010	Christie et al.	.....	D28/48
D616,147	S	*	5/2010	Adams	.....	D28/46
2007/0107231	A1	*	5/2007	Brown et al.	.....	30/50
2007/0180700	A9	*	8/2007	Sandor et al.	.....	30/41

\* cited by examiner

*Primary Examiner* — Jennifer Rivard

(74) *Attorney, Agent, or Firm* — Ronald Terk Sia; Kevin C.  
Johnson; Steven W. Miller

(57) **CLAIM**

We claim the ornamental design for a shaving razor, as shown  
and described.

**DESCRIPTION**

FIG. 1 is a perspective view of the ornamental appearance of a shaving razor, in accordance with the present invention; FIG. 2 is a frontal planar view of the shaving razor of FIG. 1; FIG. 3 is a back planar view of the shaving razor of FIG. 1; FIG. 4 is a side view of the shaving razor of FIG. 1; FIG. 5 is another side view of the shaving razor of FIG. 1, opposite the side view shown in FIG. 4; FIG. 6 is a top planar view of the shaving razor of FIG. 1; FIG. 7 is a bottom planar view of the shaving razor of FIG. 1; FIG. 8 is a perspective view of another ornamental appearance of an embodiment of a shaving razor, in accordance with the present invention; FIG. 9 is a frontal planar view of the shaving razor of FIG. 8; FIG. 10 is a back planar view of the shaving razor of FIG. 8; FIG. 11 is a side view of the shaving razor of FIG. 8; FIG. 12 is another side view of the shaving razor of FIG. 8, opposite the side view shown in FIG. 11; FIG. 13 is a top planar view of the shaving razor of FIG. 8; and, FIG. 14 is a bottom planar view of the shaving razor of FIG. 8.

The broken lines shown in the drawings illustrate portions of the article and form no part of the claimed design.

**1 Claim, 8 Drawing Sheets**

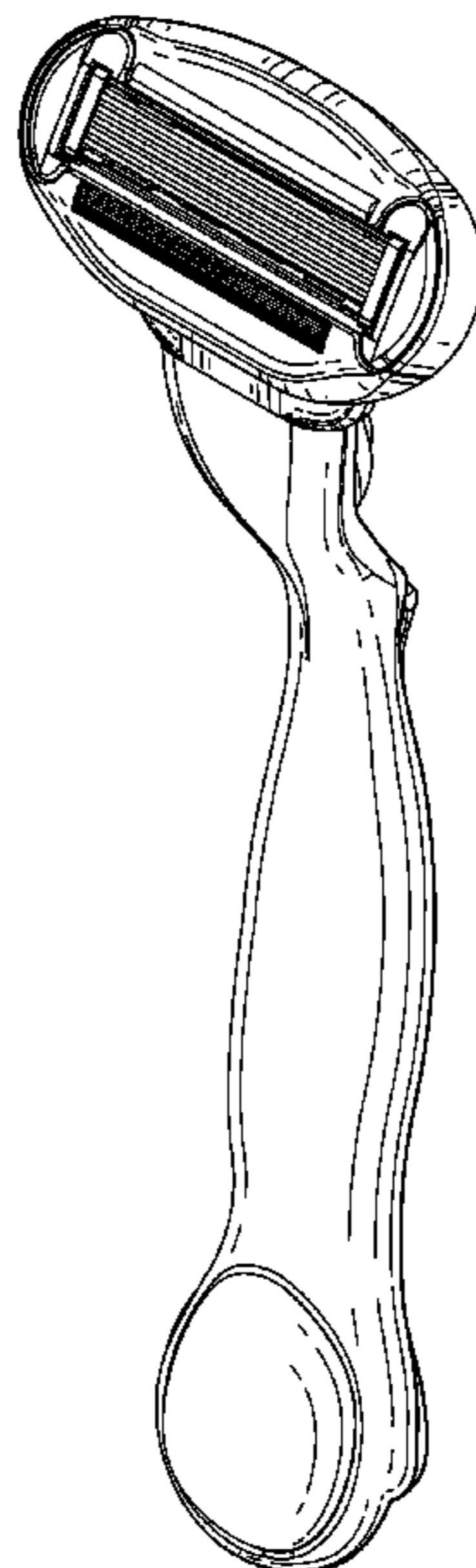

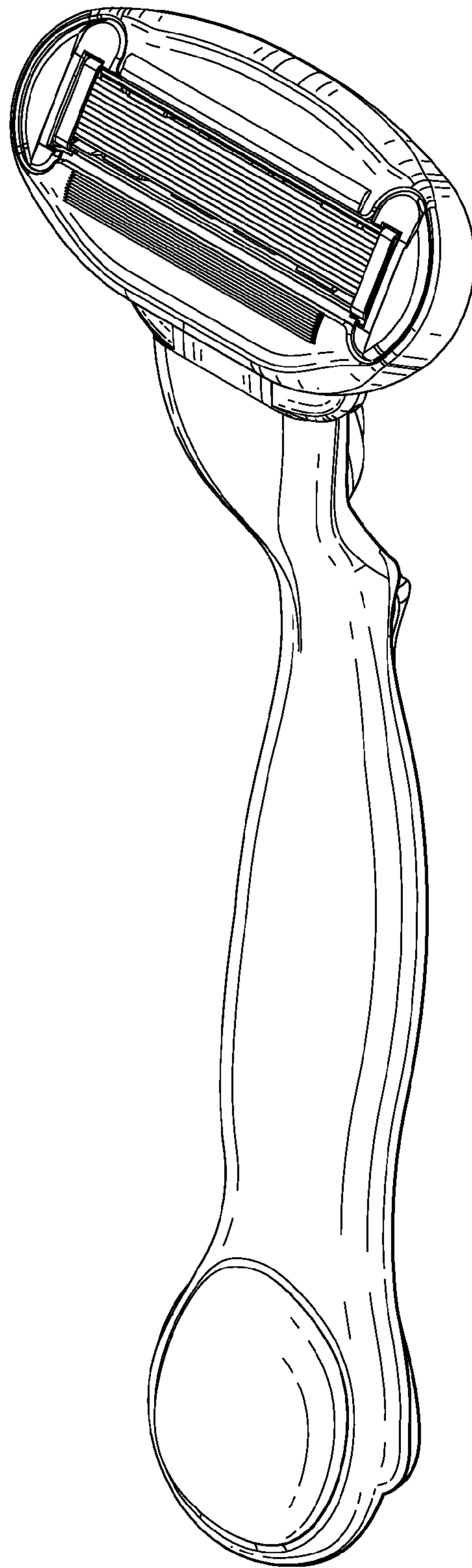
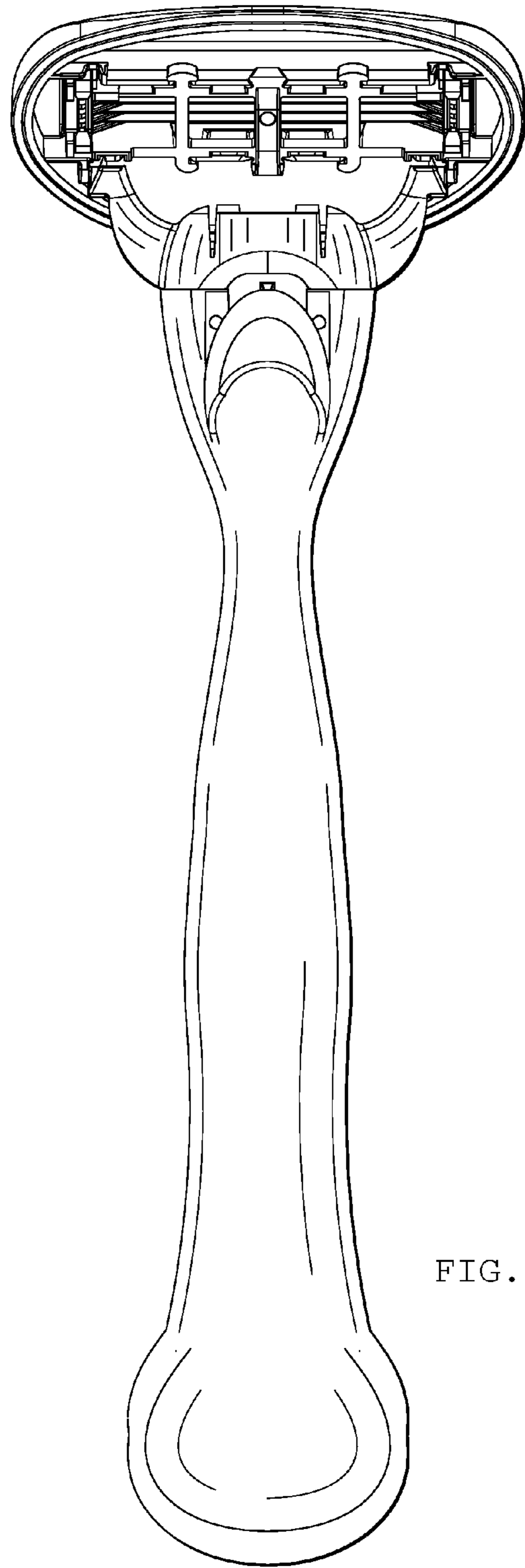
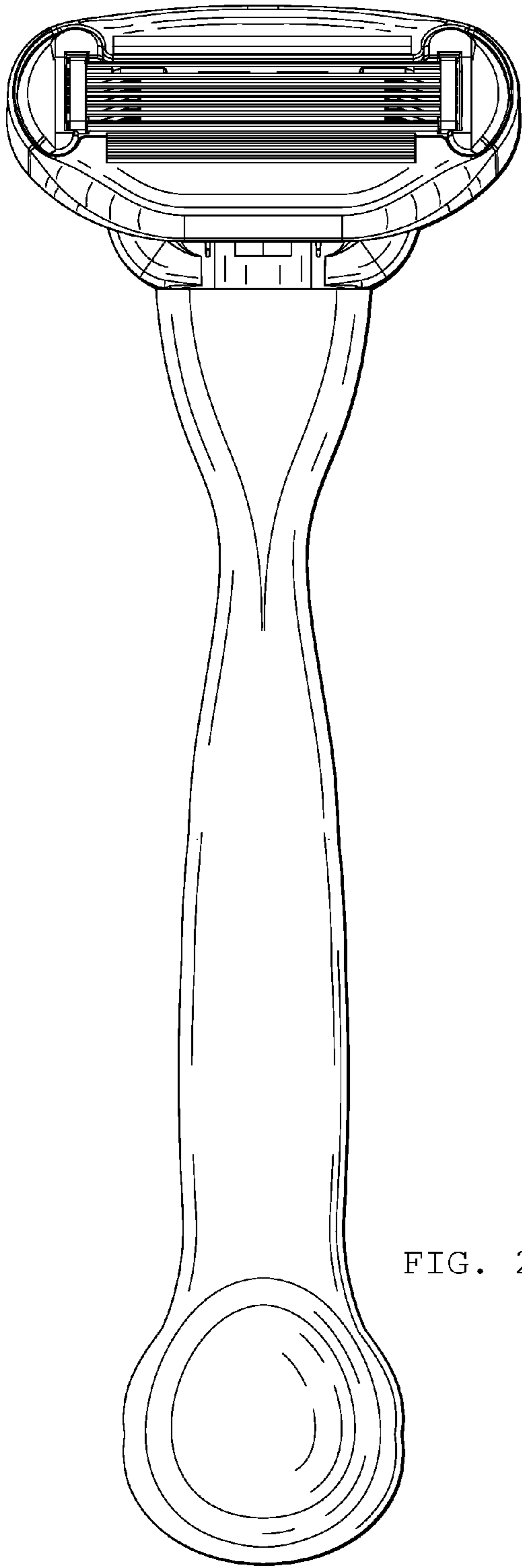

FIG. 1



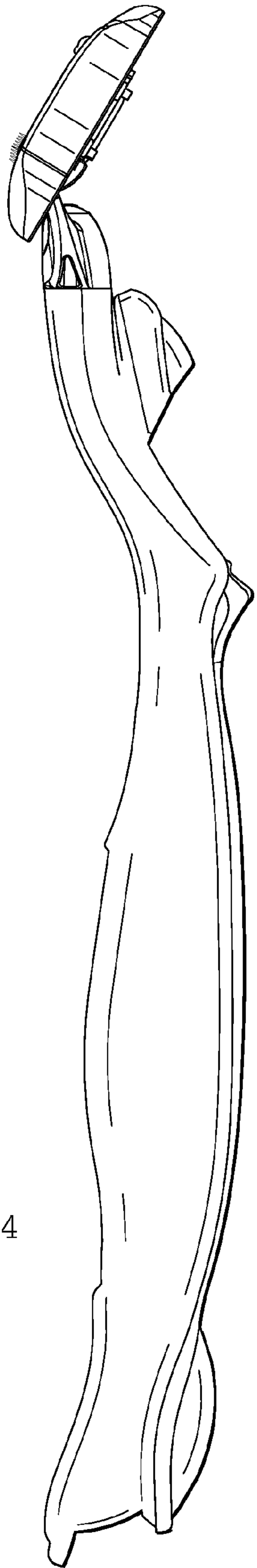

FIG. 4



FIG. 5



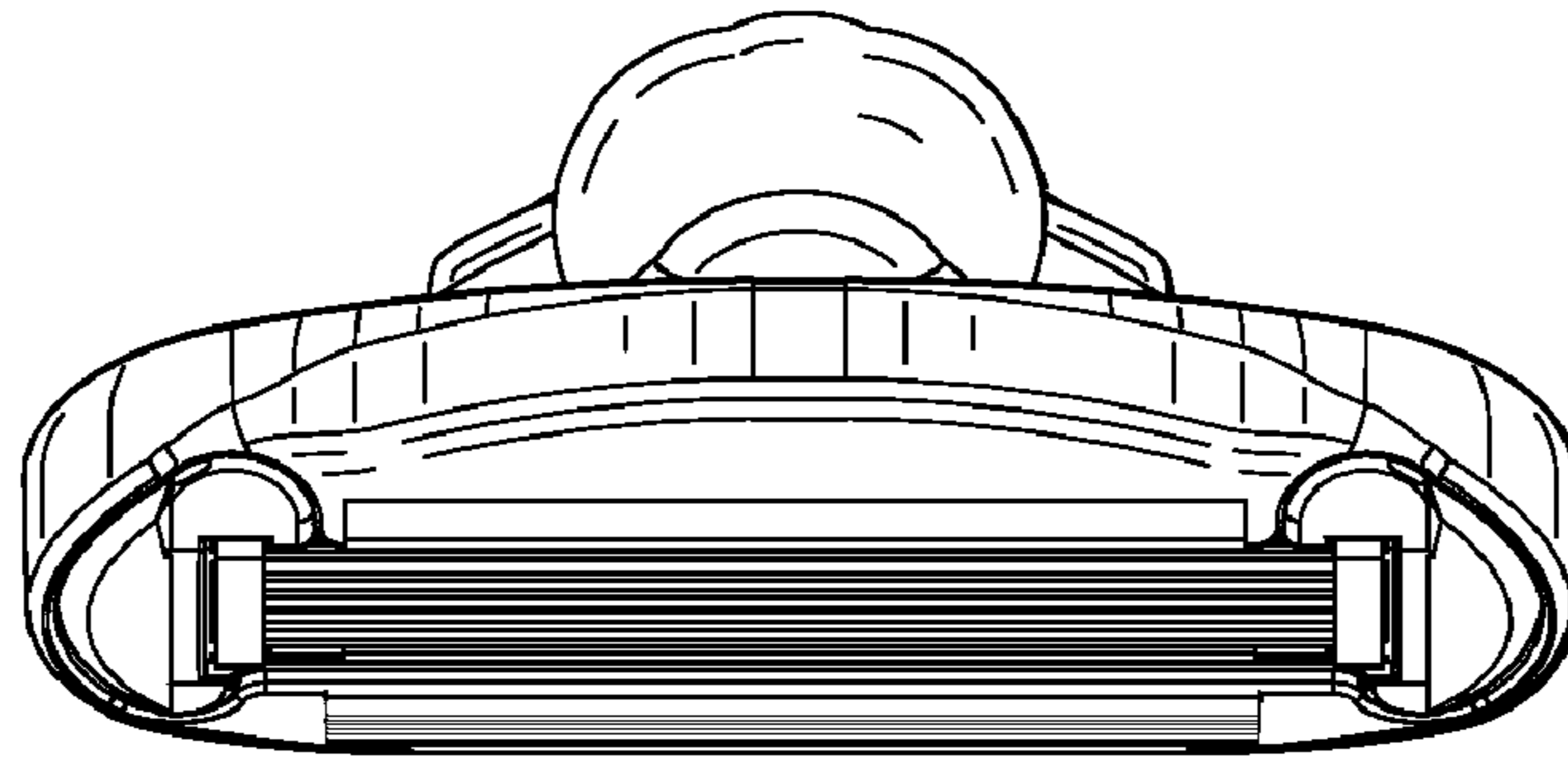

FIG. 6

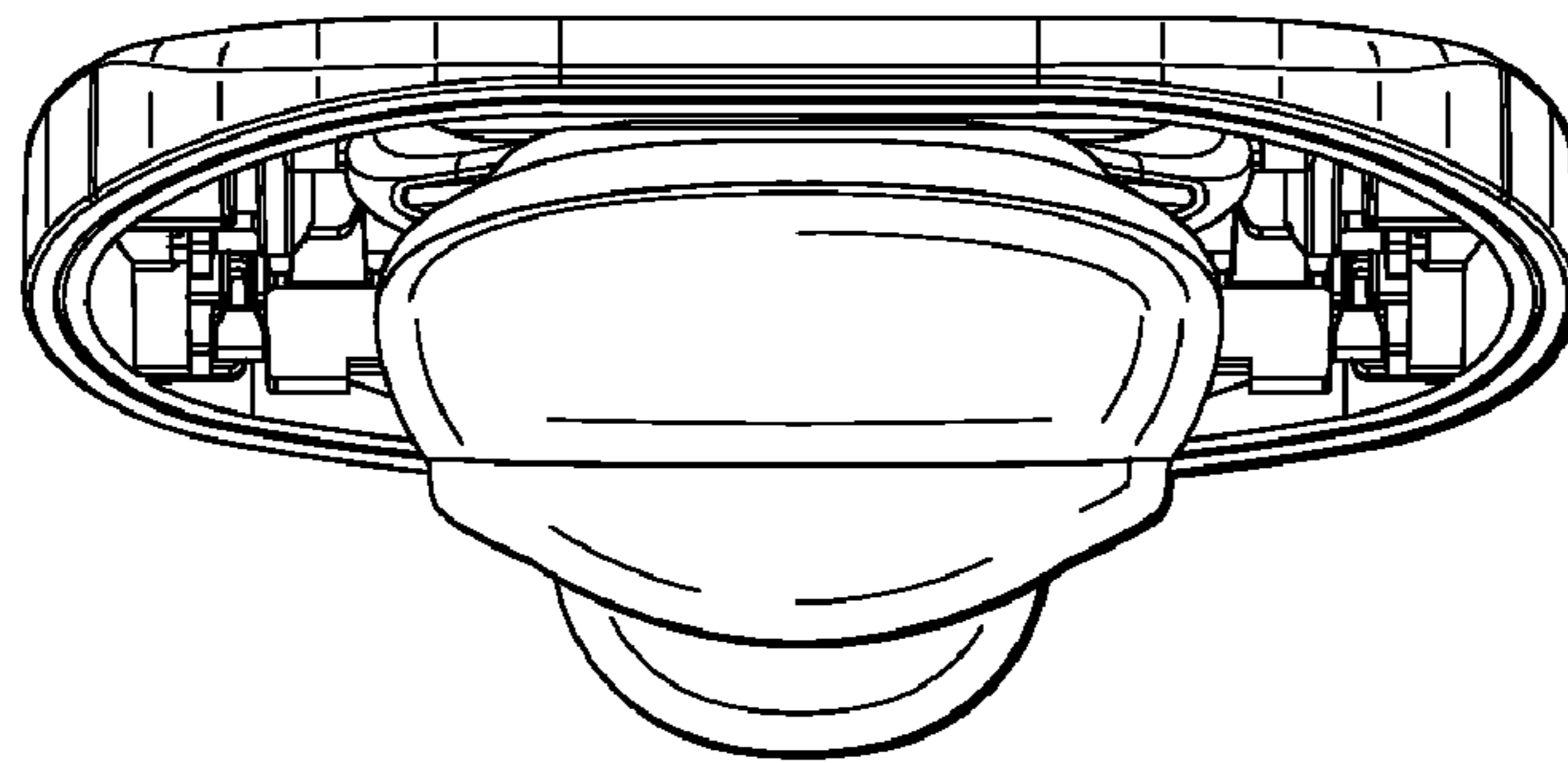

FIG. 7

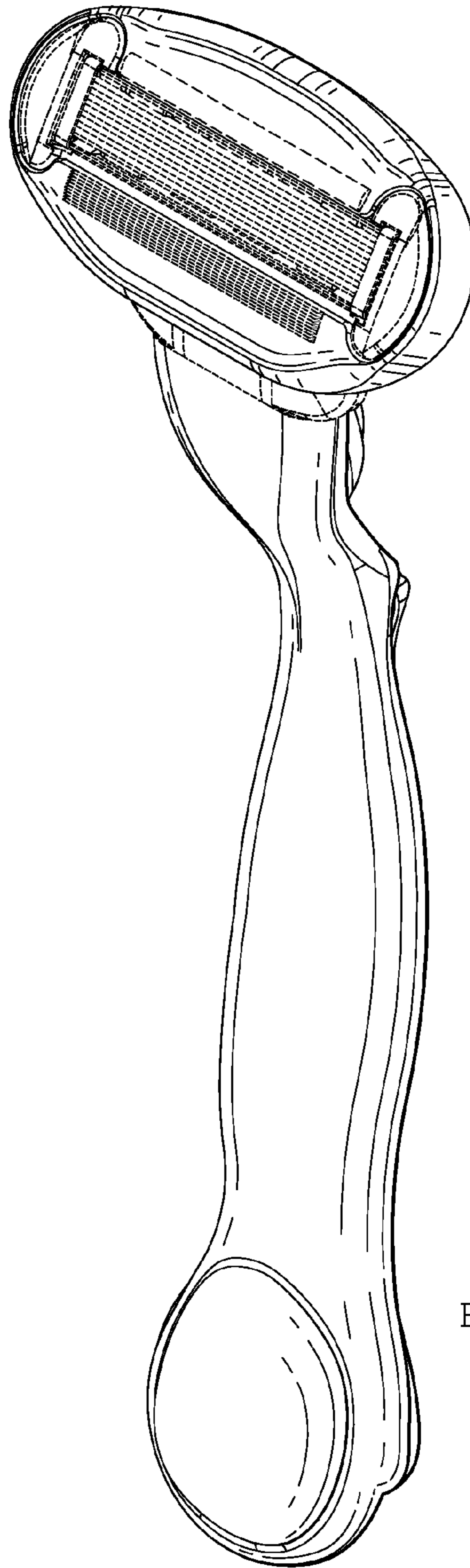
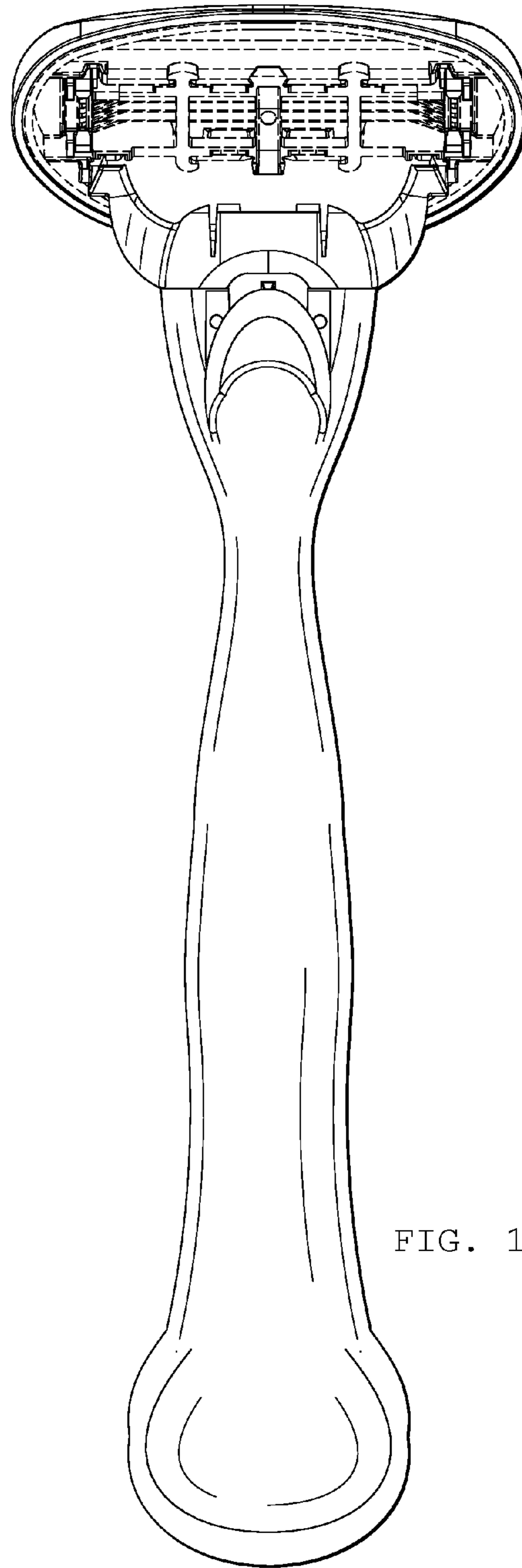
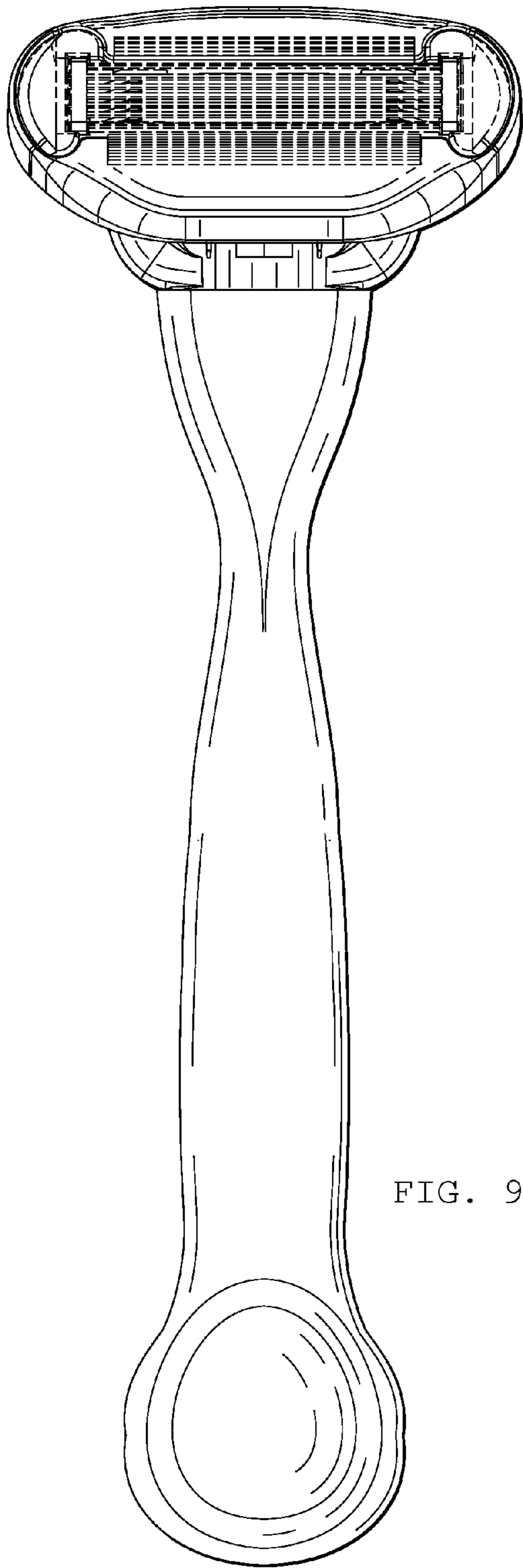

FIG. 8



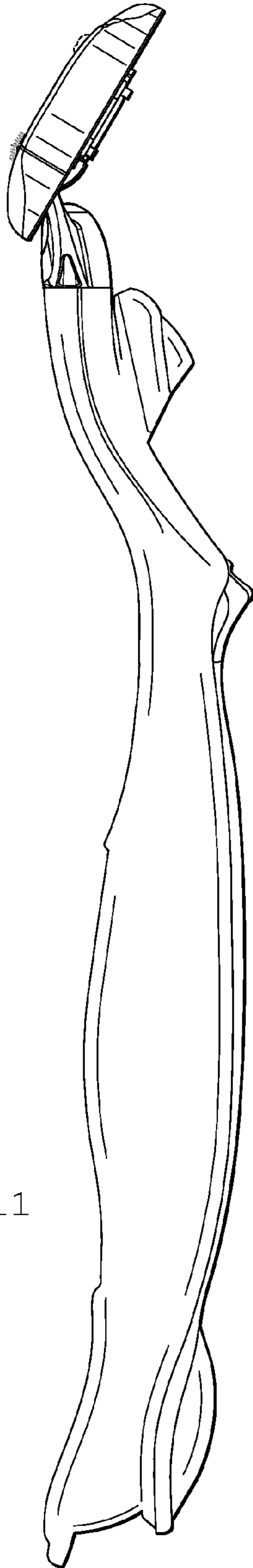

FIG. 11

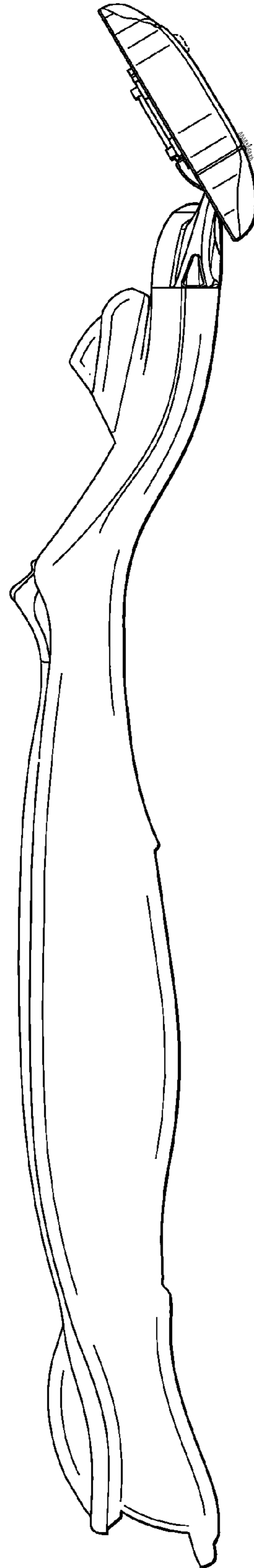

FIG. 12



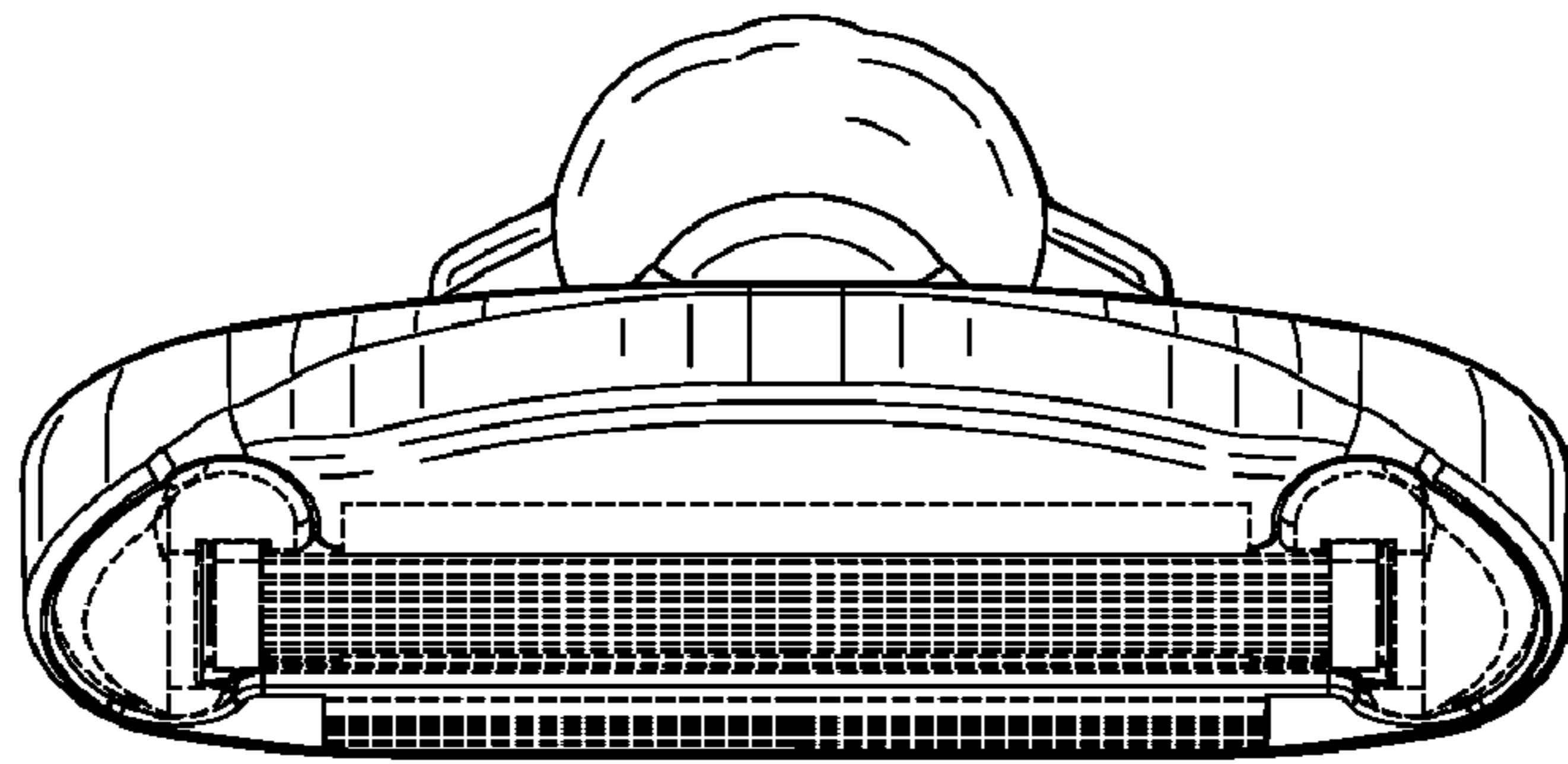

FIG. 13

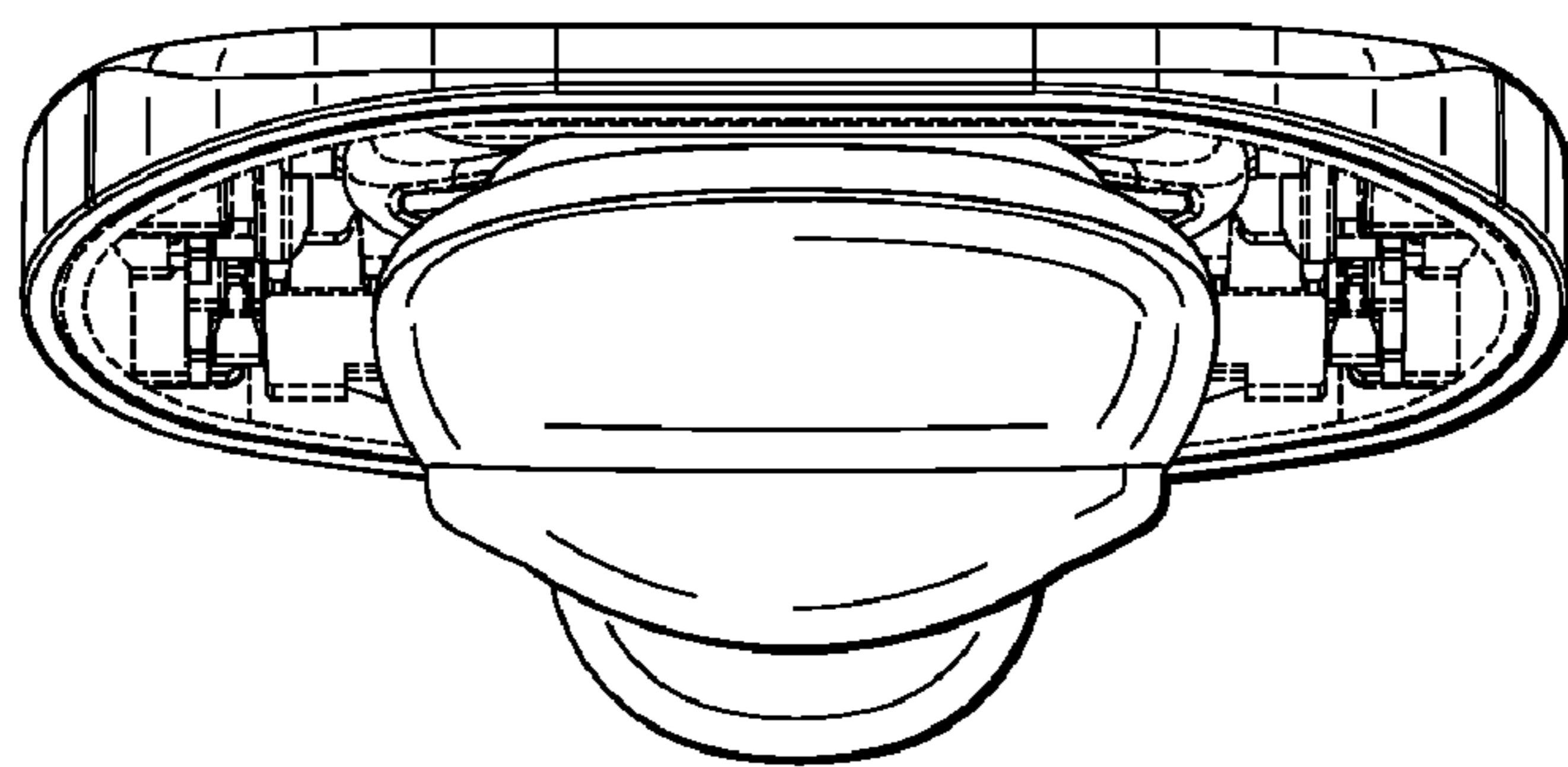

FIG. 14