



US00D638291S

(12) **United States Design Patent**
England

(10) **Patent No.:** **US D638,291 S**

(45) **Date of Patent:** **** *May 24, 2011**

(54) **CIGARETTE PACKAGE**

(75) Inventor: **John England**, Mamaroneck, NY (US)

(73) Assignee: **British American Tobacco (Investments) Limited**, London (GB)

(*) Notice: This patent is subject to a terminal disclaimer.

(**) Term: **14 Years**

(21) Appl. No.: **29/317,652**

(22) Filed: **May 2, 2008**

(51) **LOC (9) Cl.** **09-03**

(52) **U.S. Cl.** **D9/432; D9/433**

(58) **Field of Classification Search** D9/430-433, D9/414, 418, 420-424; D3/272; 206/267, 206/269, 270, 273, 299, 737, 740, 822, 37; 229/100, 101, 101.3, 106, 108-112, 114-117, 229/117.05-117.09, 117.24-117.26, 221, 229/222, 227, 902, 939, 941, 942; D27/189
See application file for complete search history.

(56) **References Cited**

U.S. PATENT DOCUMENTS

291,201	A *	1/1884	Kinney	206/242
960,922	A *	6/1910	Hirschwitz et al.	446/76
1,548,237	A *	8/1925	Ackermann	229/107
2,030,992	A *	2/1936	Keller	206/267
2,078,665	A *	4/1937	Horsley	206/267
2,333,416	A *	11/1943	Ducey	206/256
2,547,005	A *	4/1951	Herrick et al.	229/90
2,744,624	A *	5/1956	Hoogstoel et al.	206/426
2,782,977	A *	2/1957	Thompson	206/521
2,798,596	A *	7/1957	Emmons	206/418
3,165,249	A *	1/1965	Peck	225/43
3,203,617	A *	8/1965	Paige	206/418
3,732,663	A *	5/1973	Geldmacher	53/412
5,207,322	A *	5/1993	Focke et al.	206/268
5,277,315	A *	1/1994	Plein	206/270

(Continued)

FOREIGN PATENT DOCUMENTS

DE 10106547 A1 * 8/2002

(Continued)

Primary Examiner — Karen Acker

(74) *Attorney, Agent, or Firm* — Chadbourne & Parke LLP; Walter G. Hanchuk

(57) **CLAIM**

The ornamental design for a cigarette package, as shown and described.

DESCRIPTION

FIG. 1 is a perspective view of a first embodiment of the cigarette package showing the design of the disclosed invention;

FIG. 2 is a front view thereof;

FIG. 3 is a back view thereof;

FIG. 4 is a side view thereof;

FIG. 5 is a side view thereof;

FIG. 6 is a top view thereof;

FIG. 7 is a bottom view thereof;

FIG. 8 shows a blank of the first embodiment of the cigarette package shown in FIGS. 1-7;

FIG. 9 is a perspective view of a second embodiment of the cigarette package showing the design of the disclosed invention;

FIG. 10 is a front view thereof;

FIG. 11 is a back view thereof;

FIG. 12 is a side view thereof;

FIG. 13 is a side view thereof;

FIG. 14 is a top view thereof;

FIG. 15 is a bottom view thereof;

FIG. 16 shows a blank of the second embodiment of the cigarette package shown in FIGS. 9-15;

FIG. 17 is a perspective view of a third embodiment of the cigarette package showing the design of the disclosed invention;

FIG. 18 is a front view thereof;

FIG. 19 is a back view thereof;

FIG. 20 is a side view thereof;

FIG. 21 is a side view thereof;

FIG. 22 is a top view thereof;

FIG. 23 is a bottom view thereof; and,

FIG. 24 shows a blank of the third embodiment of the cigarette package shown in FIGS. 17-23.

The broken lines in the drawings represent unclaimed environmental subject matter.

1 Claim, 24 Drawing Sheets

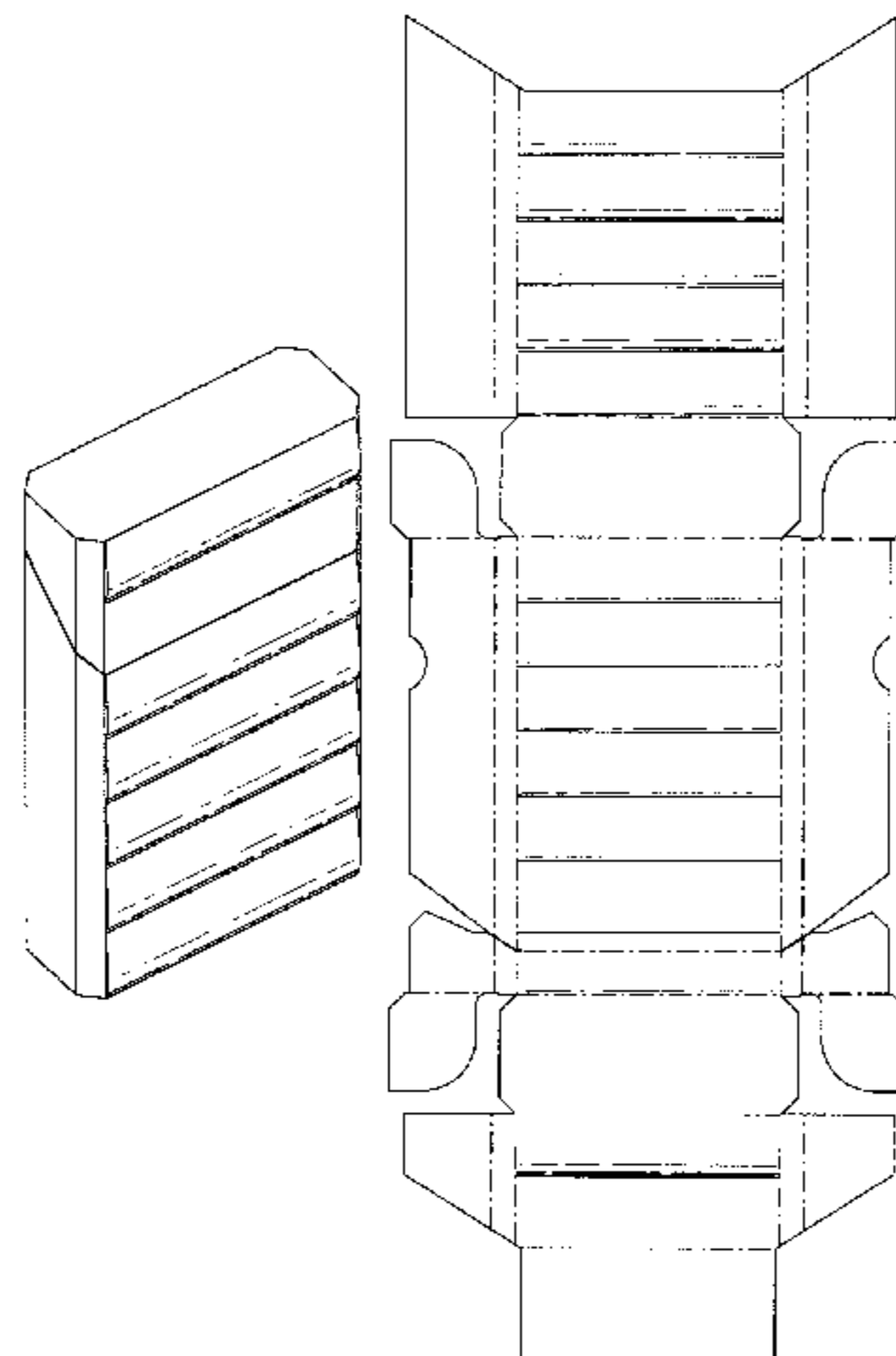

US D638,291 S

Page 2

U.S. PATENT DOCUMENTS

5,366,077 A * 11/1994 Pham 206/268
5,478,011 A * 12/1995 Pham 229/160.1
5,487,468 A * 1/1996 Sheahan 206/242
5,904,244 A * 5/1999 Focke et al. 206/268
5,924,627 A * 7/1999 Wilder et al. 229/182.1
5,964,345 A * 10/1999 Gamberini 206/259
6,276,600 B1 * 8/2001 Rigby 229/128
6,302,322 B1 * 10/2001 Focke et al. 229/160.1
6,592,023 B2 * 7/2003 Li Vigni et al. 229/146
6,941,728 B1 * 9/2005 Bray et al. 53/449
6,974,027 B2 * 12/2005 Boriani et al. 206/268
7,044,294 B2 * 5/2006 Lutzig 206/259
7,455,176 B2 * 11/2008 Focke et al. 206/268
7,506,755 B2 * 3/2009 Buse et al. 206/268
7,562,772 B2 * 7/2009 Lutzig 206/259

2002/0070220 A1 * 6/2002 Kuehn et al. 220/350
2005/0000128 A1 * 1/2005 Chen 40/454
2005/0121340 A1 * 6/2005 Spatafora 206/259
2006/0000882 A1 * 1/2006 Darzinskas 229/403
2006/0191986 A1 * 8/2006 Focke et al. 229/146
2009/0272660 A1 * 11/2009 England 206/268
2010/0059395 A1 * 3/2010 England 206/259

FOREIGN PATENT DOCUMENTS

DE 10106548 A1 * 8/2002
DE 10106549 A1 * 8/2002
WO WO 02/064450 A1 * 8/2002
WO WO 02/064451 A1 * 8/2002
WO WO 02/064452 A1 * 8/2002
WO WO 2004080844 A1 * 9/2004

* cited by examiner

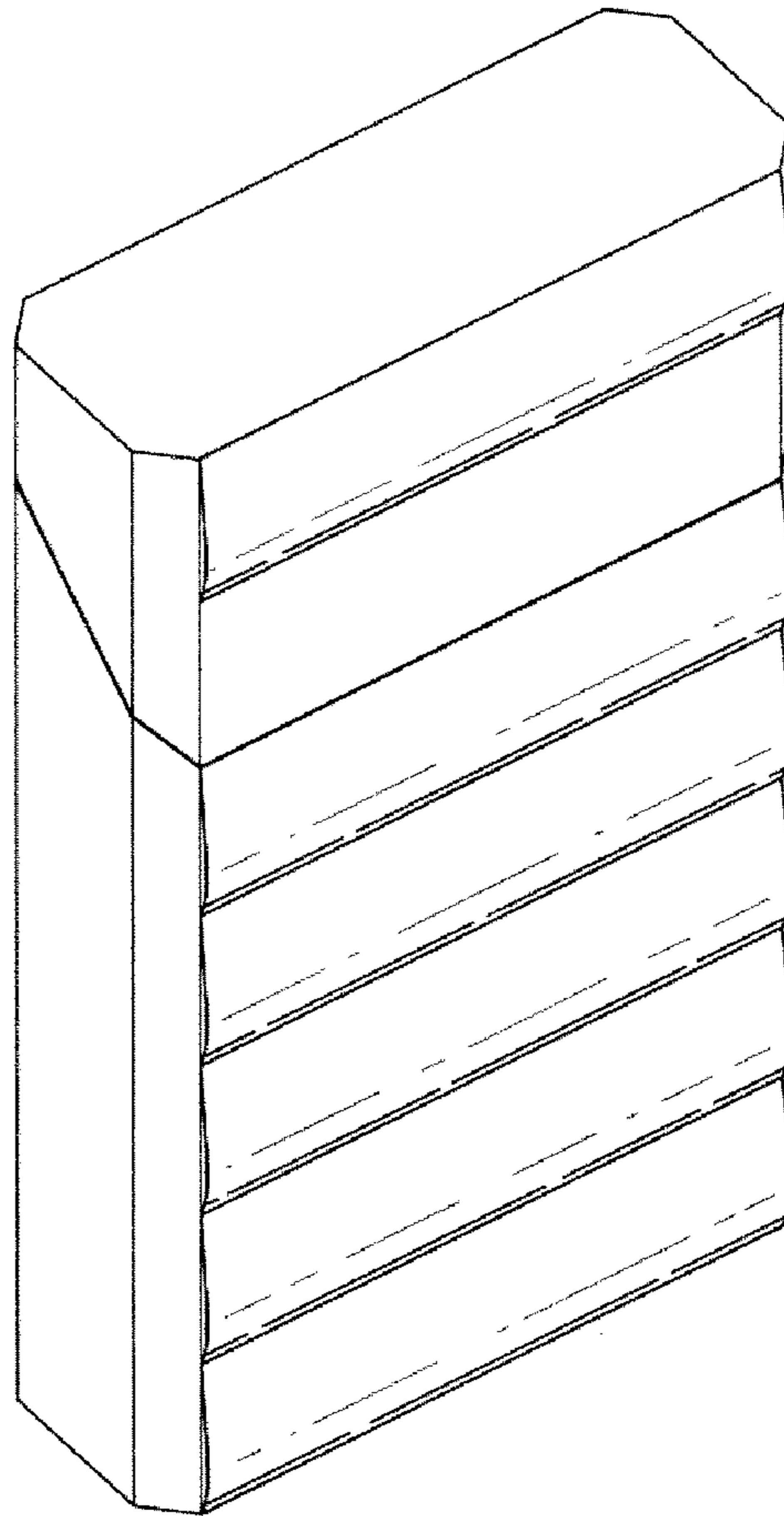

FIGURE 1

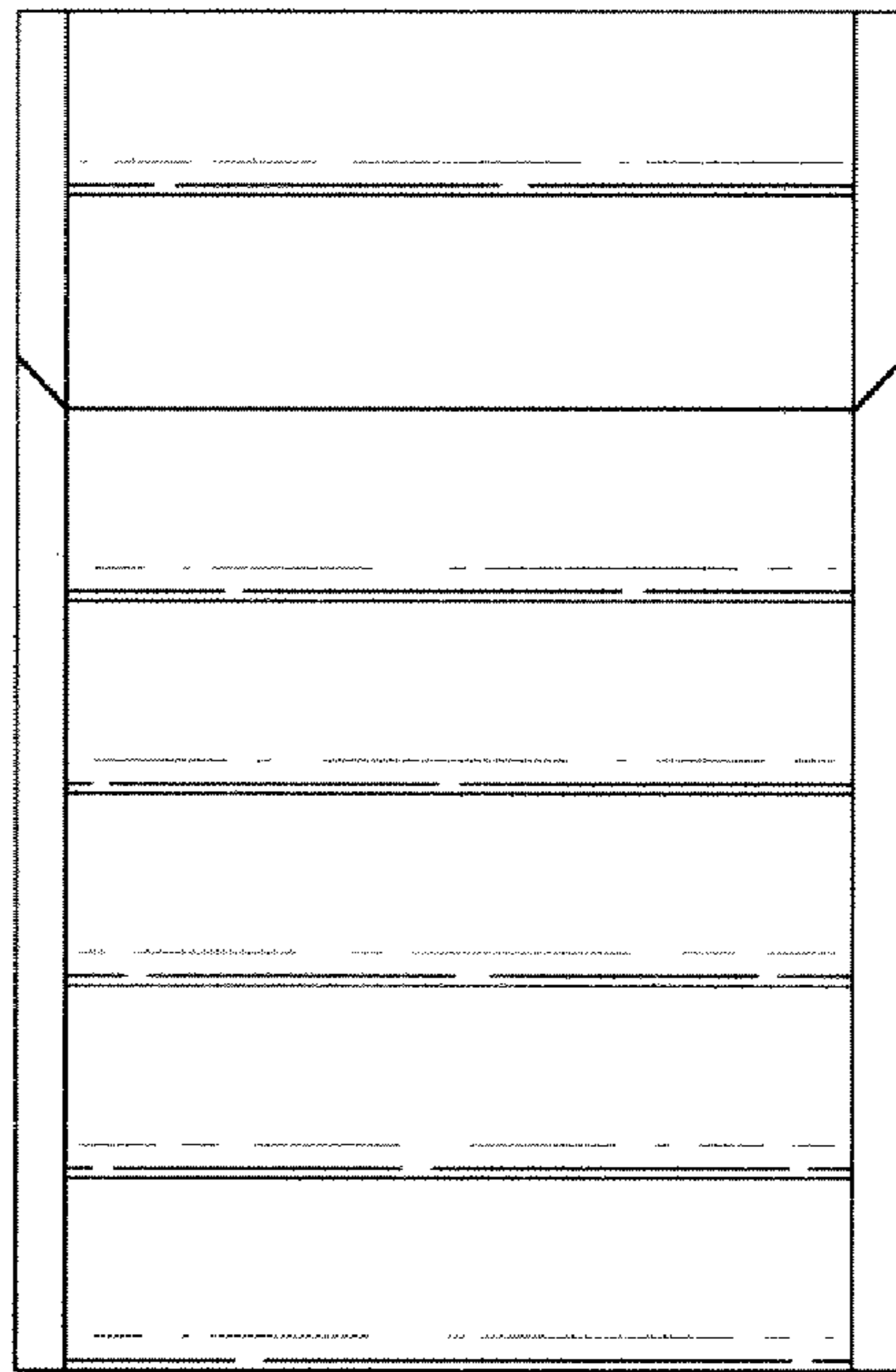

FIGURE 2

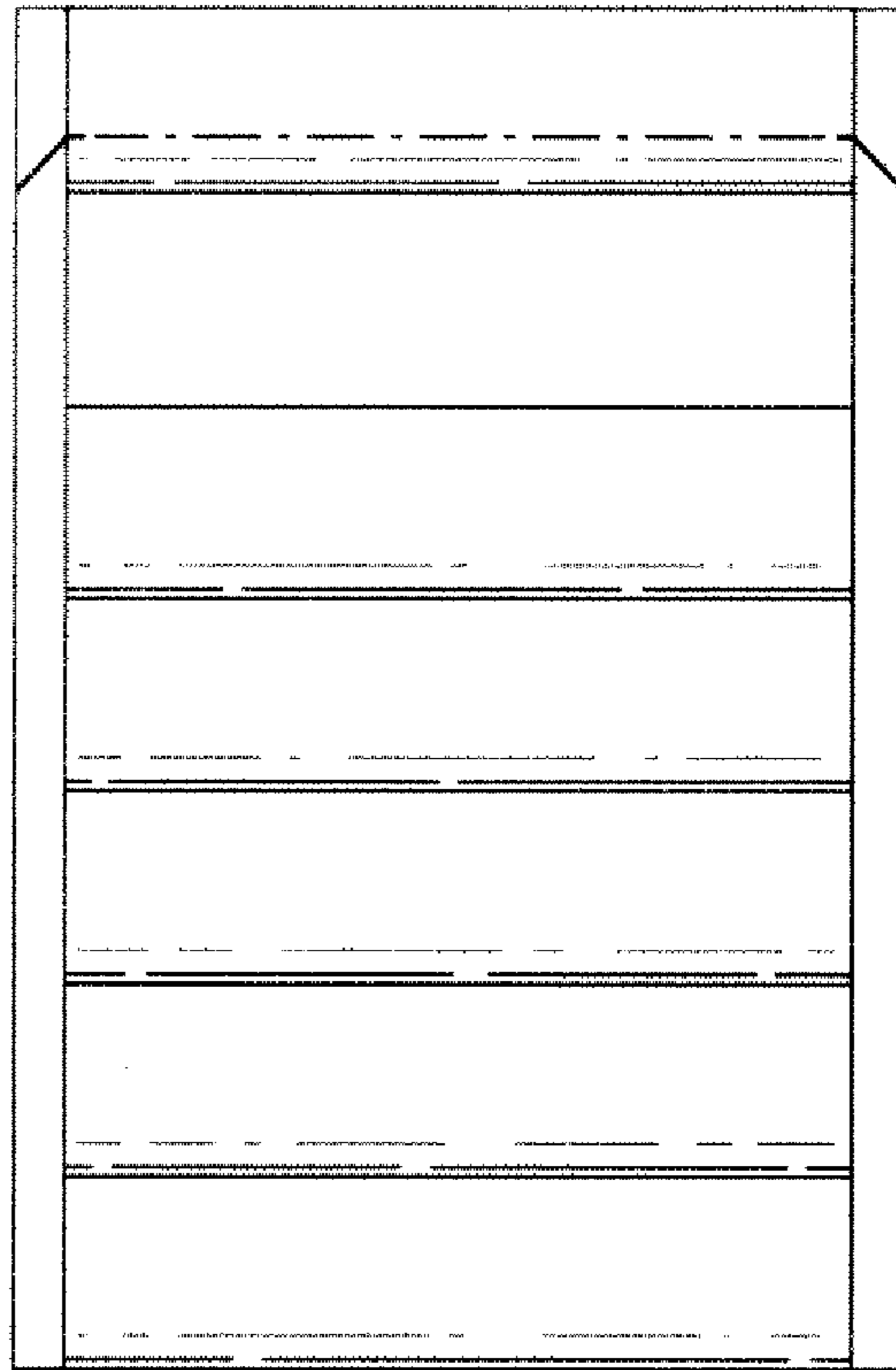

FIGURE 3

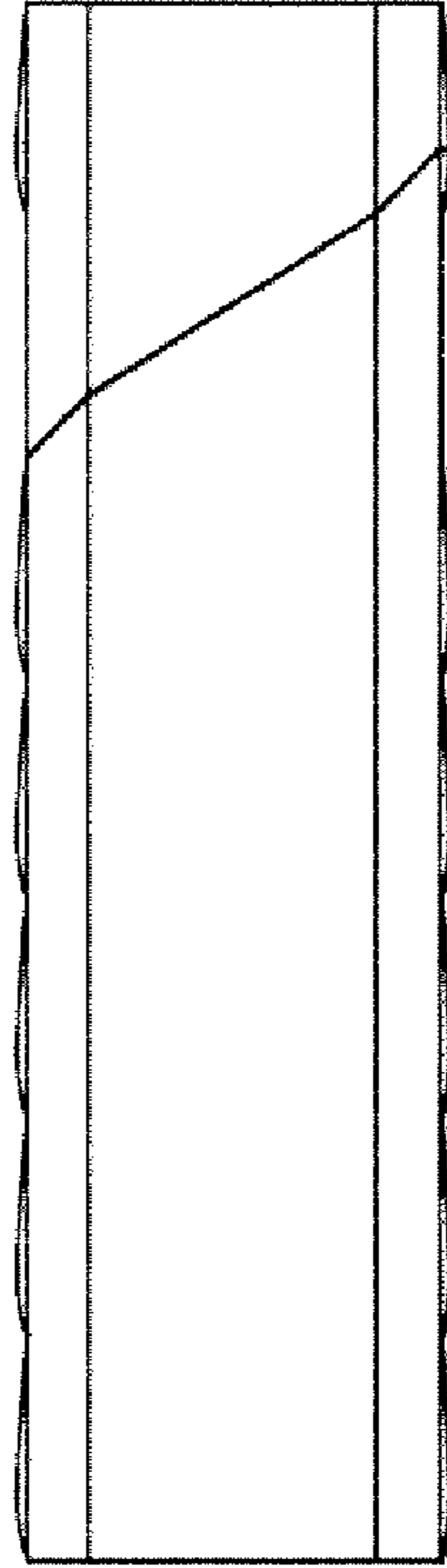

FIGURE 4

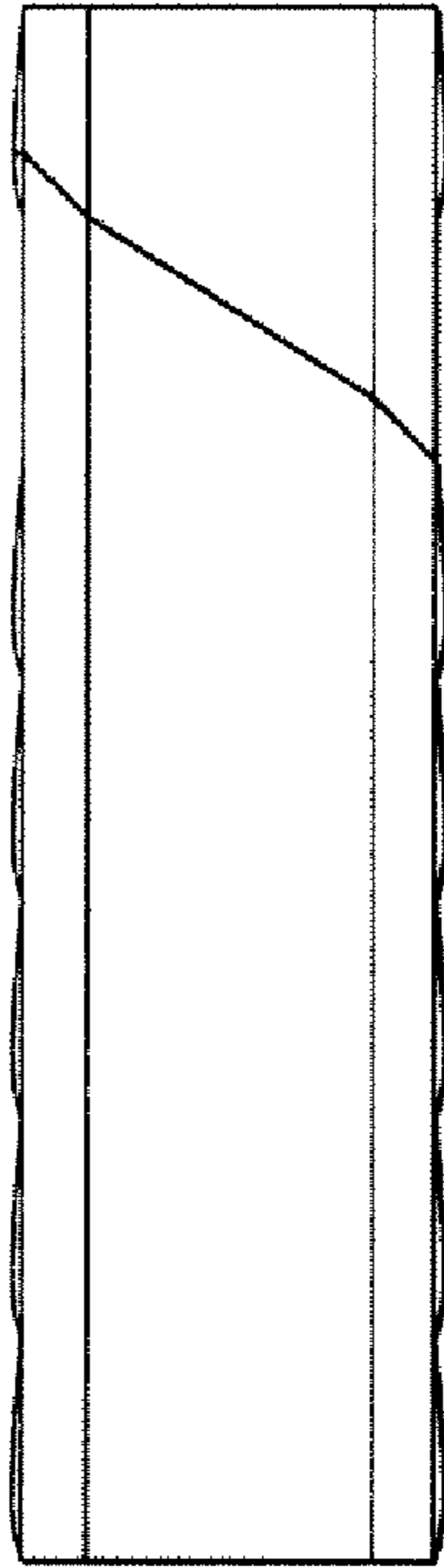

FIGURE 5



FIGURE 6

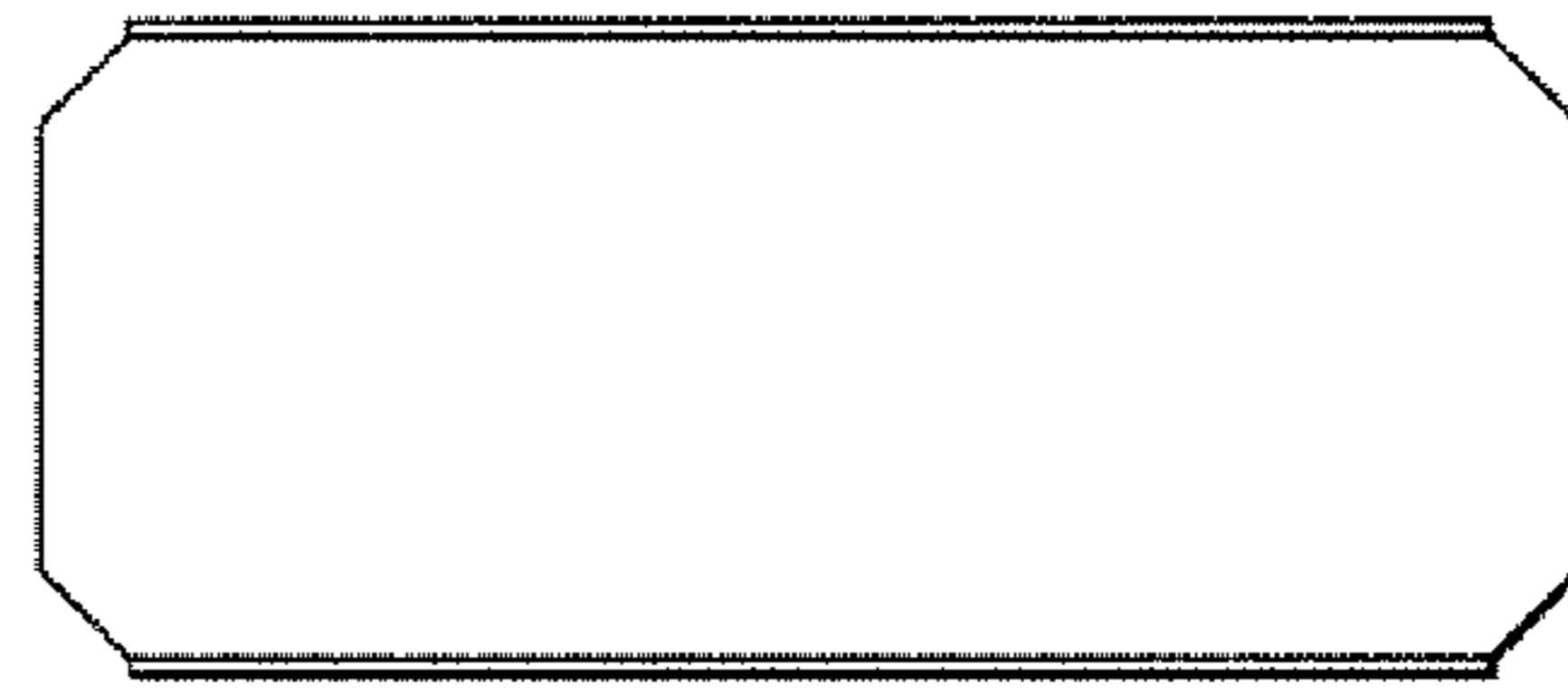

FIGURE 7

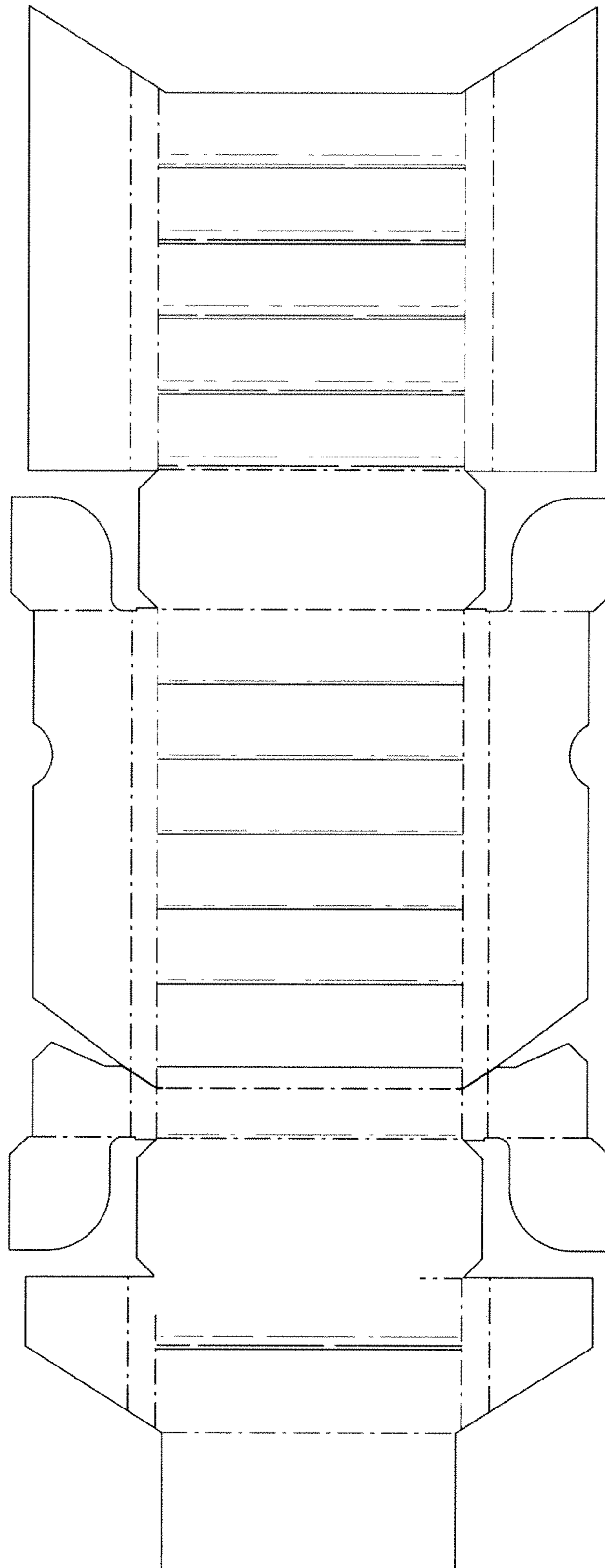

FIGURE 8

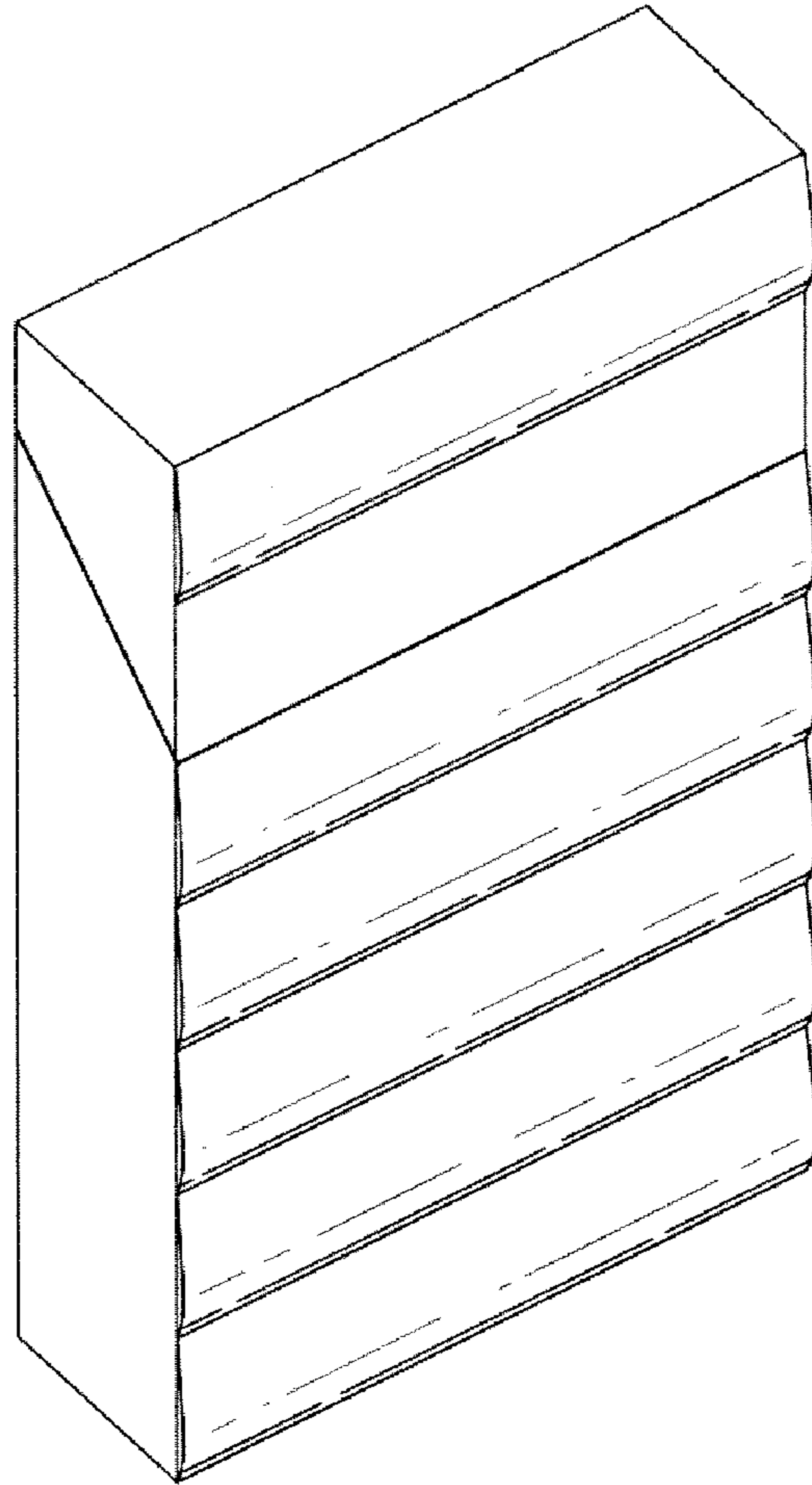

FIGURE 9

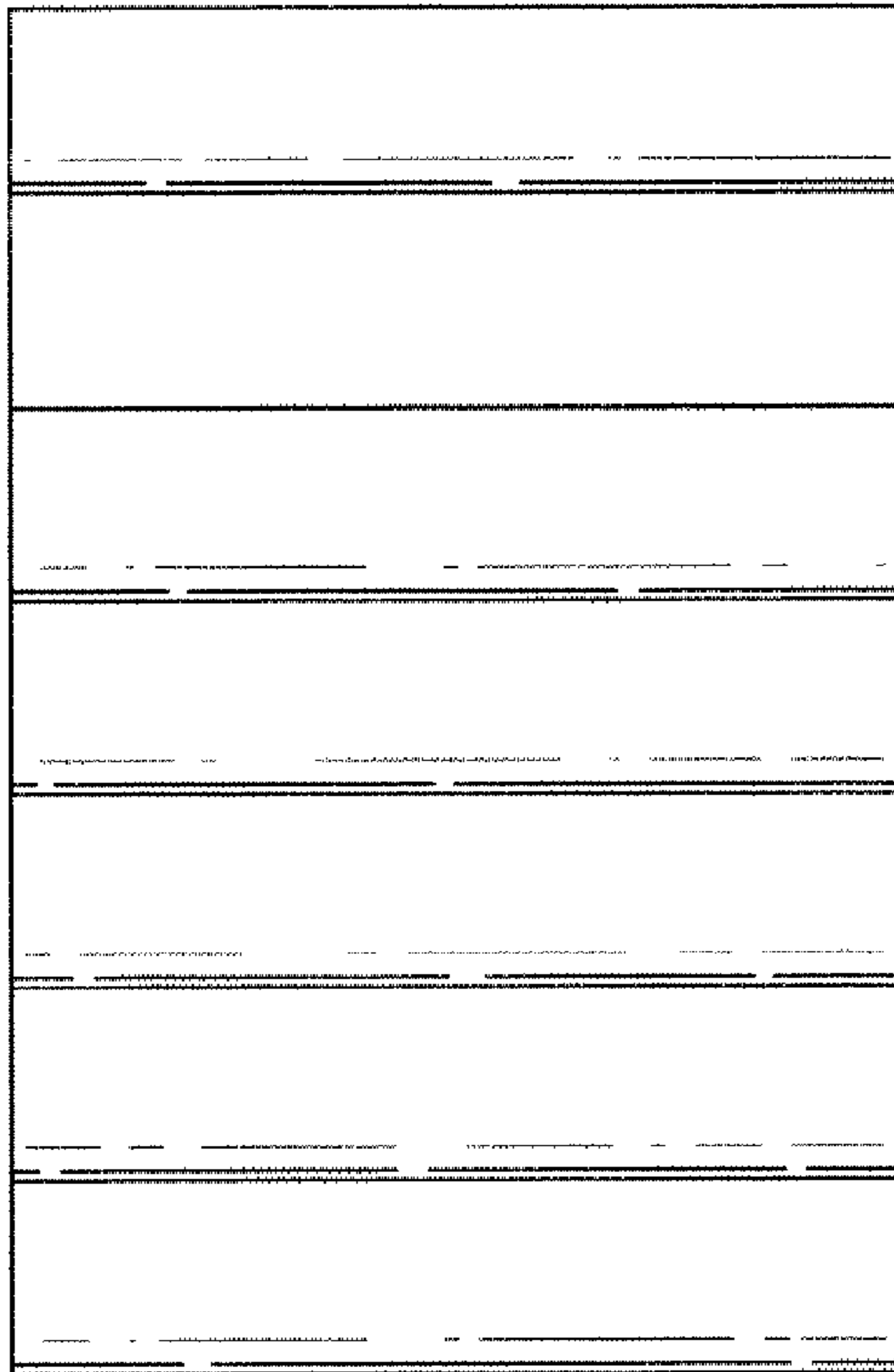

FIGURE 10

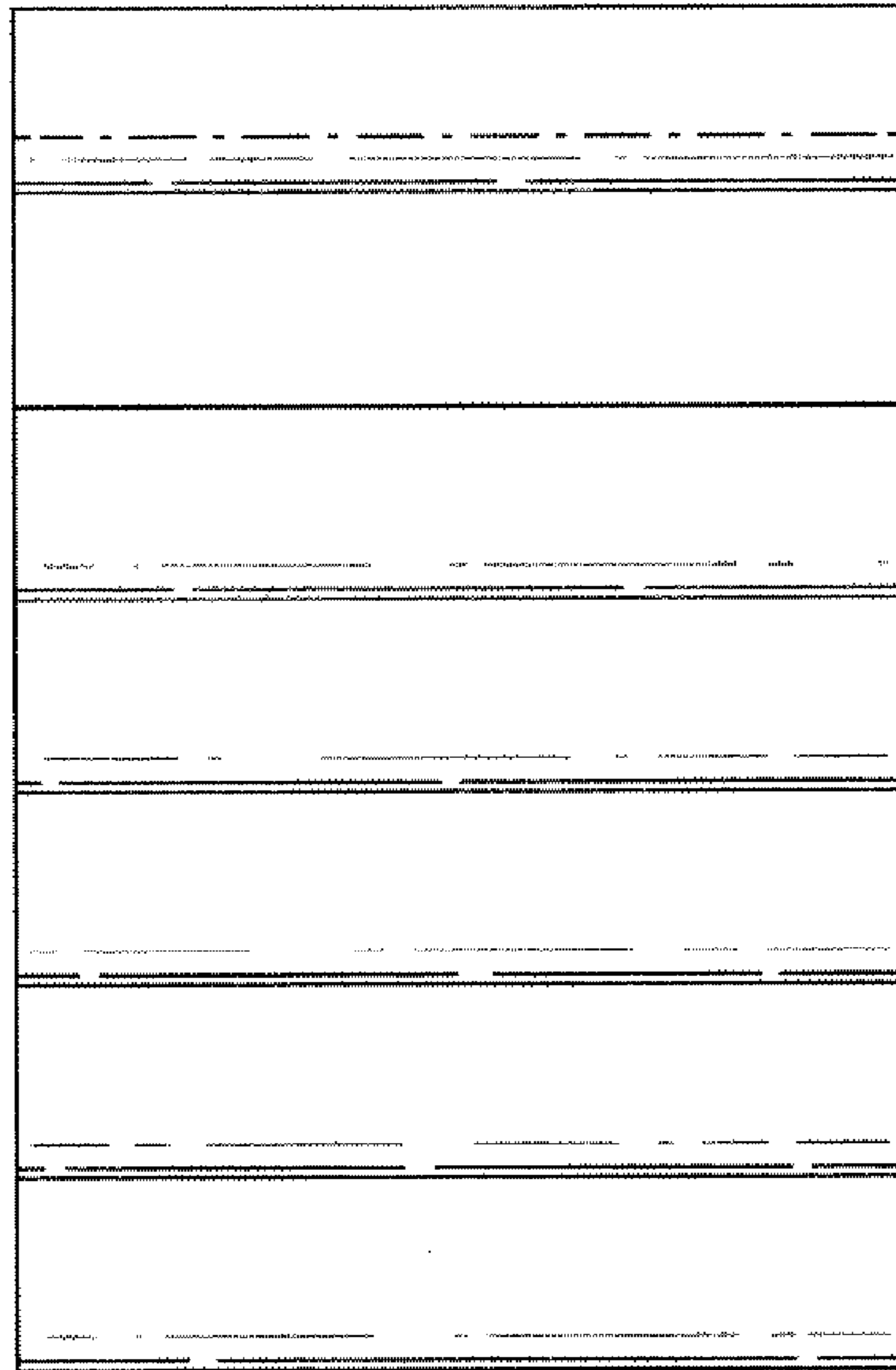

FIGURE 11

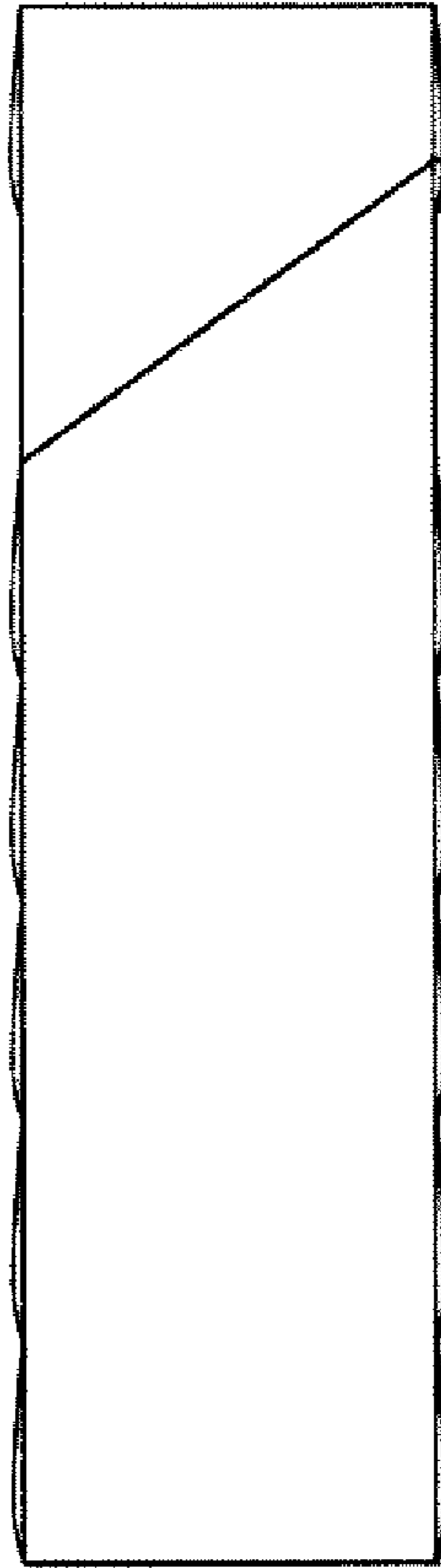

FIGURE 12

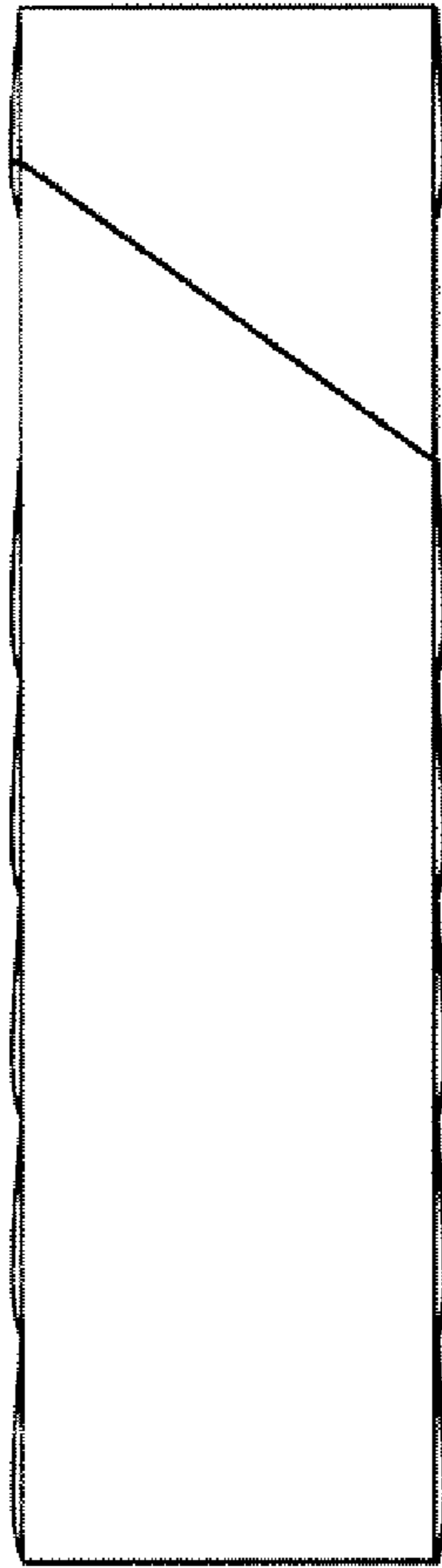

FIGURE 13



FIGURE 14



FIGURE 15

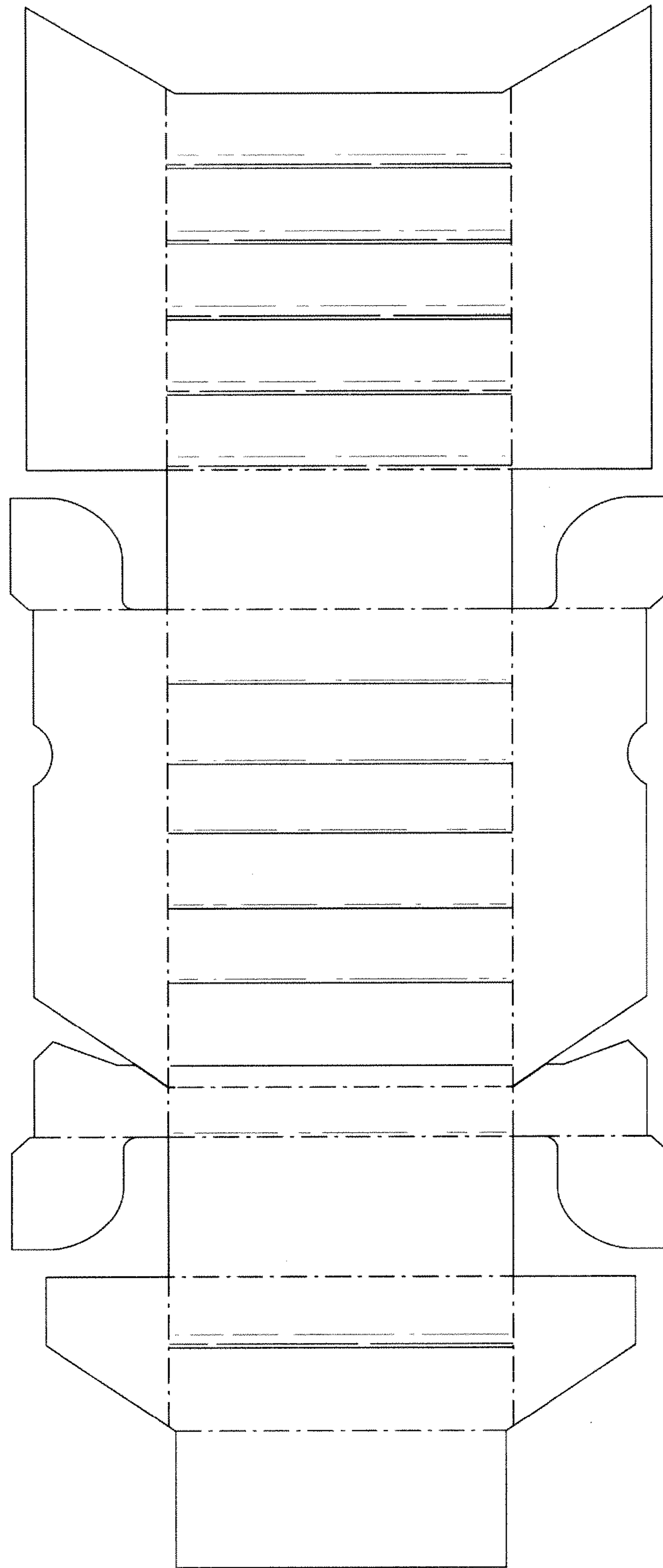

FIGURE 16

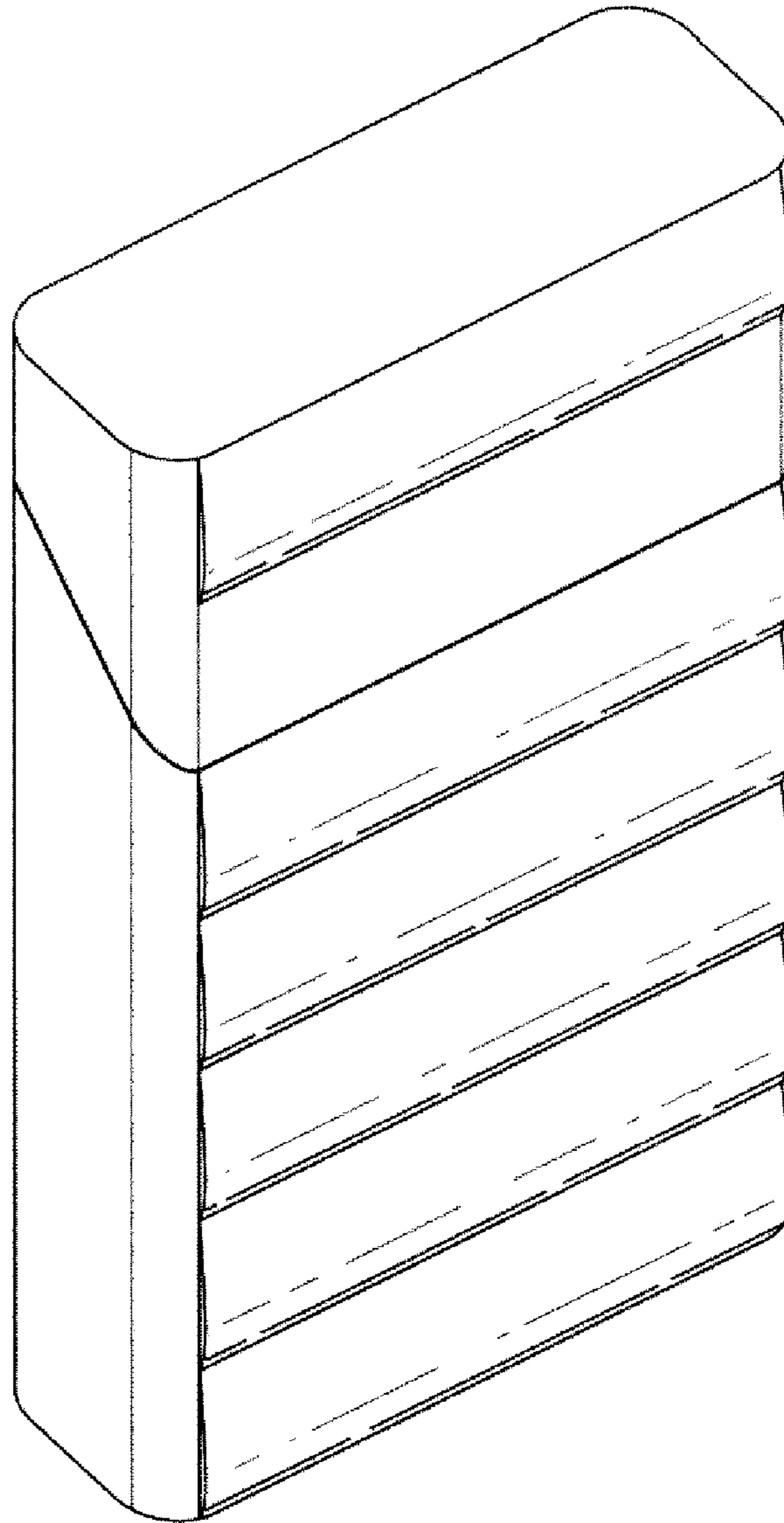

FIGURE 17

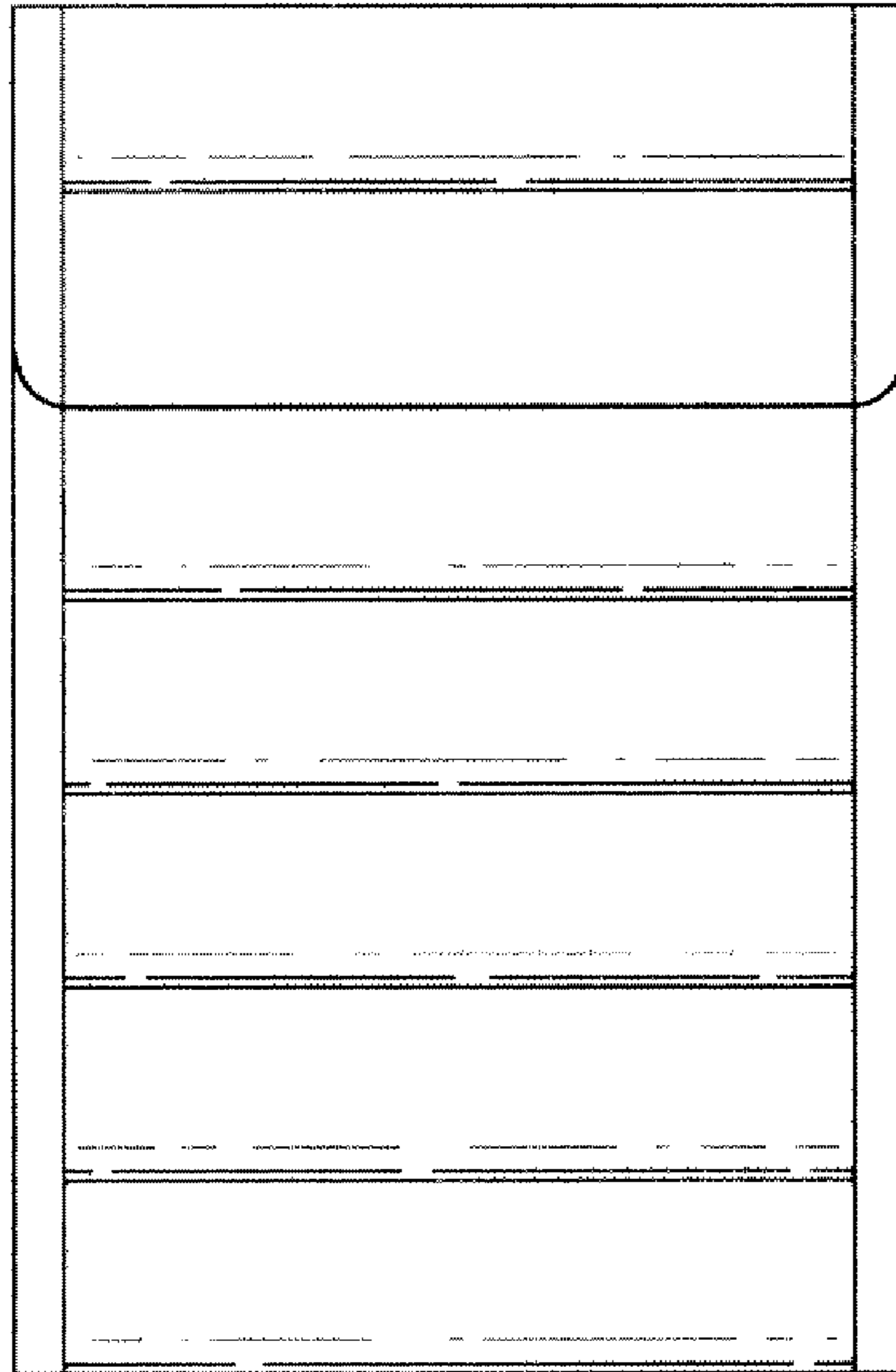

FIGURE 18

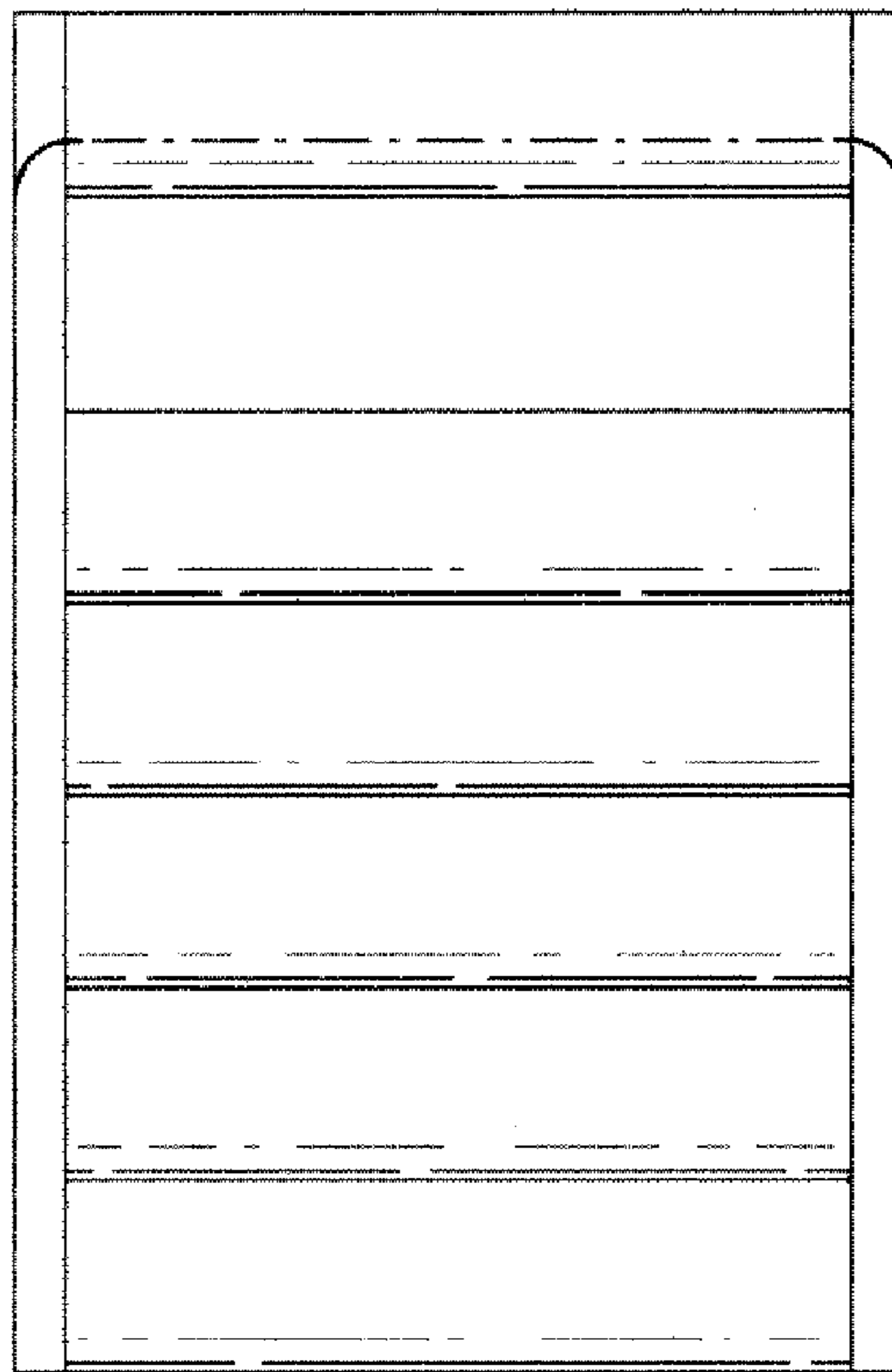

FIGURE 19

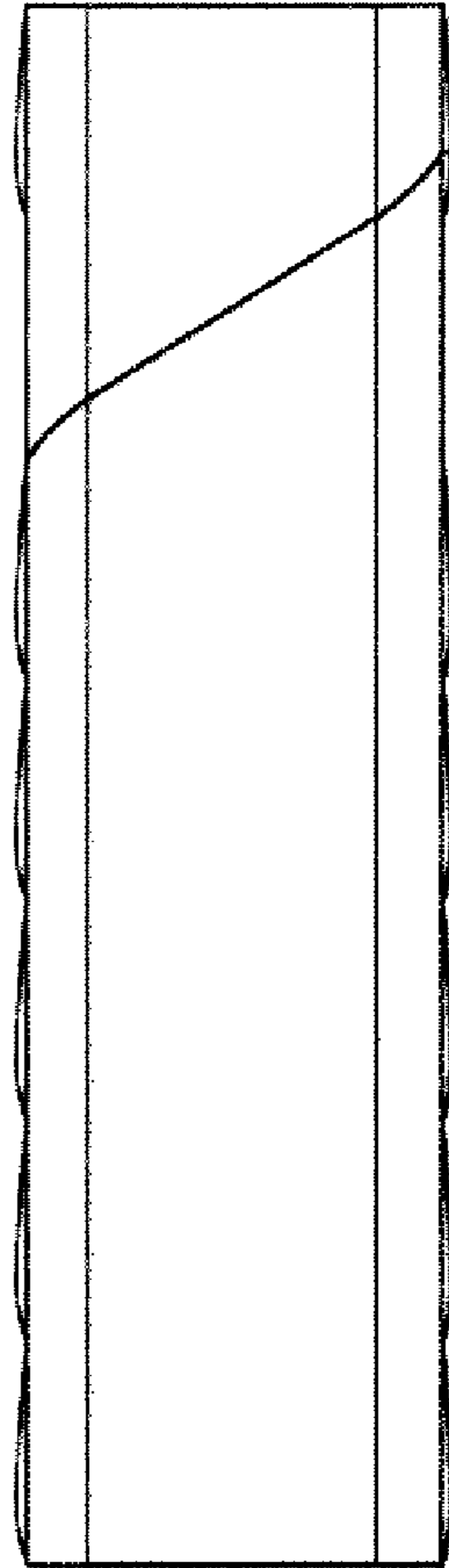

FIGURE 20

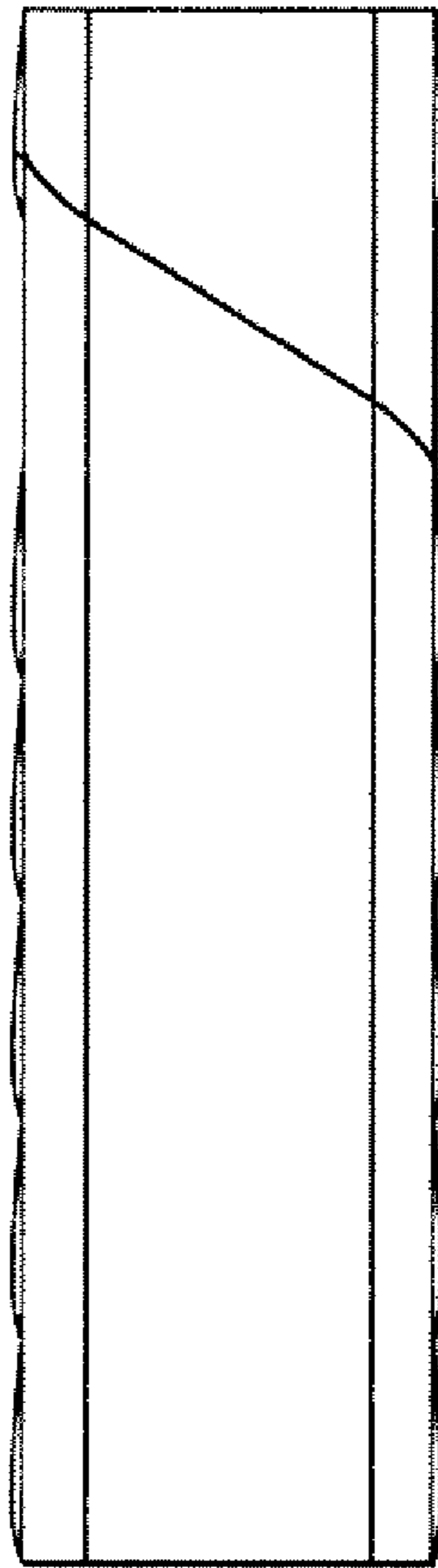

FIGURE 21



FIGURE 22

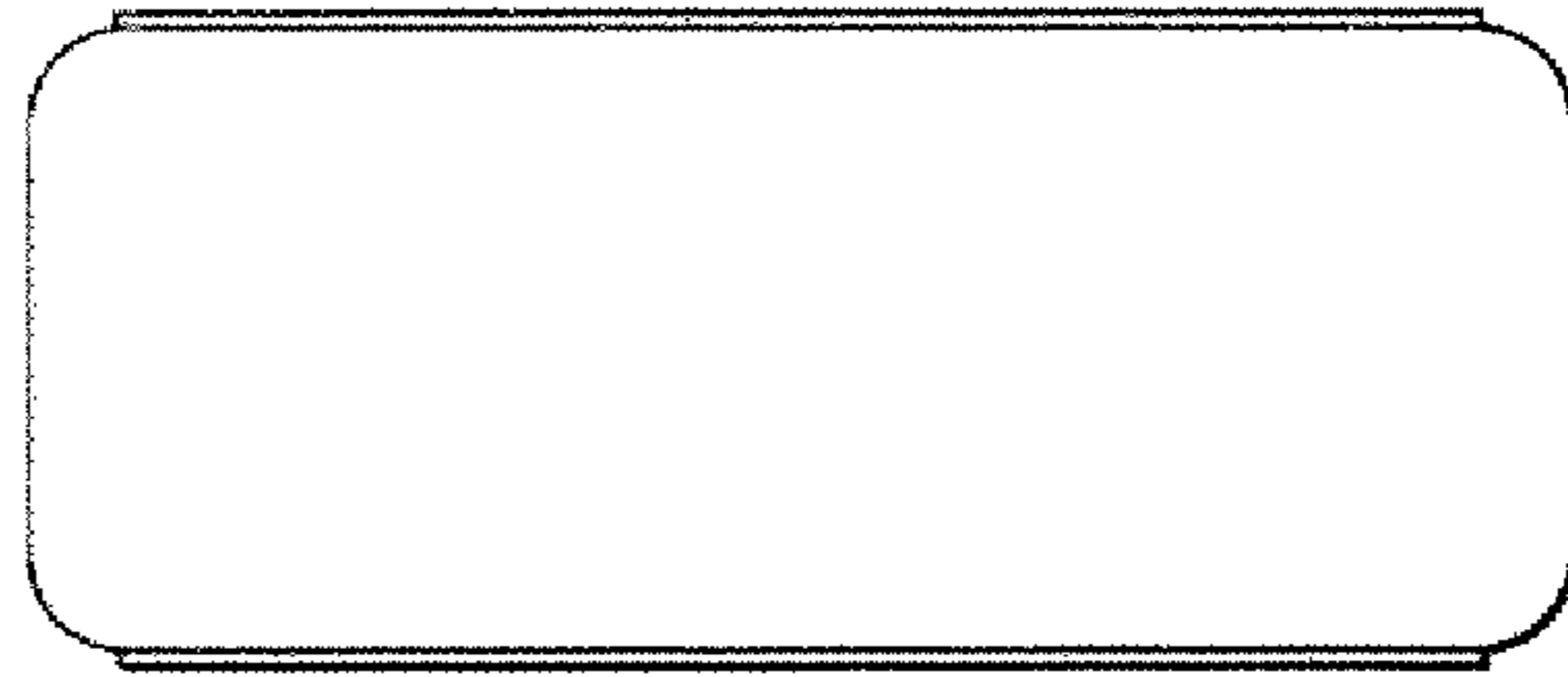

FIGURE 23

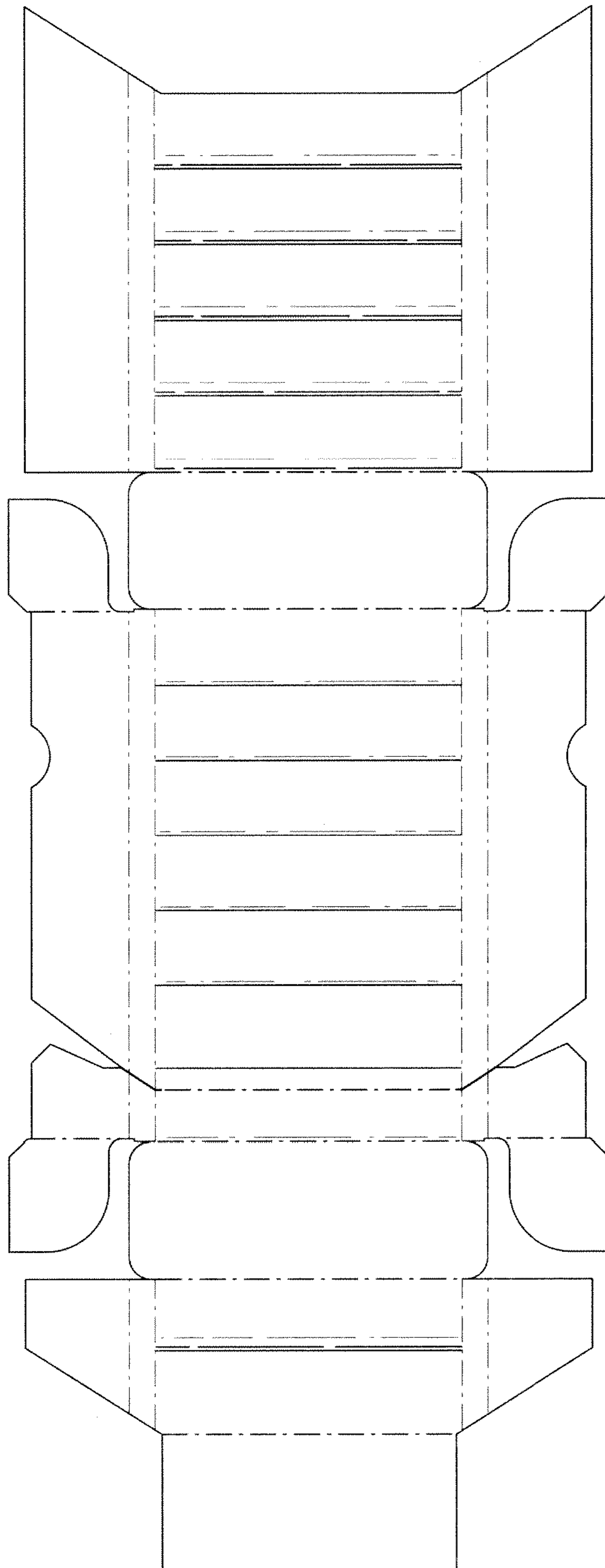

FIGURE 24