



US00D638272S

(12) **United States Design Patent**
Chen

(10) **Patent No.:** **US D638,272 S**

(45) **Date of Patent:** **** May 24, 2011**

(54) **STAPLER**

(75) Inventor: **Yun-Lung Chen**, Taipei Hsien (TW)

(73) Assignee: **Hon Hai Precision Industry Co., Ltd.**,
Tu-Cheng, New Taipei (TW)

(**) Term: **14 Years**

(21) Appl. No.: **29/380,099**

(22) Filed: **Nov. 30, 2010**

(51) **LOC (9) Cl.** **19-02**

(52) **U.S. Cl.** **D8/50**

(58) **Field of Classification Search** D8/49,
D8/50, 61, 68, 69; D19/72, 73, 65, 69; D21/532;
D24/145; 7/158, 160; 227/4, 5, 6, 7, 8, 120,
227/127, 128, 131, 132, 134, 144, 156, 175.1;
606/139, 143, 153, 219
See application file for complete search history.

(56) **References Cited**

U.S. PATENT DOCUMENTS

D147,972 S	*	11/1947	Ide	D8/50
D191,290 S	*	9/1961	Belbow	D8/49
D208,780 S	*	10/1967	Smith	D19/61
D256,326 S	*	8/1980	Murtagh	D8/50

D288,220 S	*	2/1987	Su	D21/590
D338,041 S	*	8/1993	Cheng	D19/75
D338,290 S	*	8/1993	Bart	D32/18
D433,062 S	*	10/2000	Ho	D19/72
6,338,430 B1	*	1/2002	Cheng	227/134
D491,230 S	*	6/2004	Lee	D19/72
D530,998 S	*	10/2006	Mountford	D8/50
D561,547 S	*	2/2008	Lee	D8/36
D600,381 S	*	9/2009	Choi	D26/47

* cited by examiner

Primary Examiner — Austin Murphy

(74) *Attorney, Agent, or Firm* — D. Austin Bonderer

(57) **CLAIM**

The ornamental design for a stapler, as shown and described.

DESCRIPTION

FIG. 1 is a perspective view of the thin client showing our new design;

FIG. 2 is a front elevational view thereof;

FIG. 3 is a rear elevational view thereof;

FIG. 4 is a left side elevational view thereof;

FIG. 5 is a right side elevational view thereof;

FIG. 6 is a top plan view thereof; and,

FIG. 7 is a bottom plan view thereof.

The broken lines shown in the drawings represent unclaimed portions of the stapler and form no part of the claimed design.

1 Claim, 7 Drawing Sheets

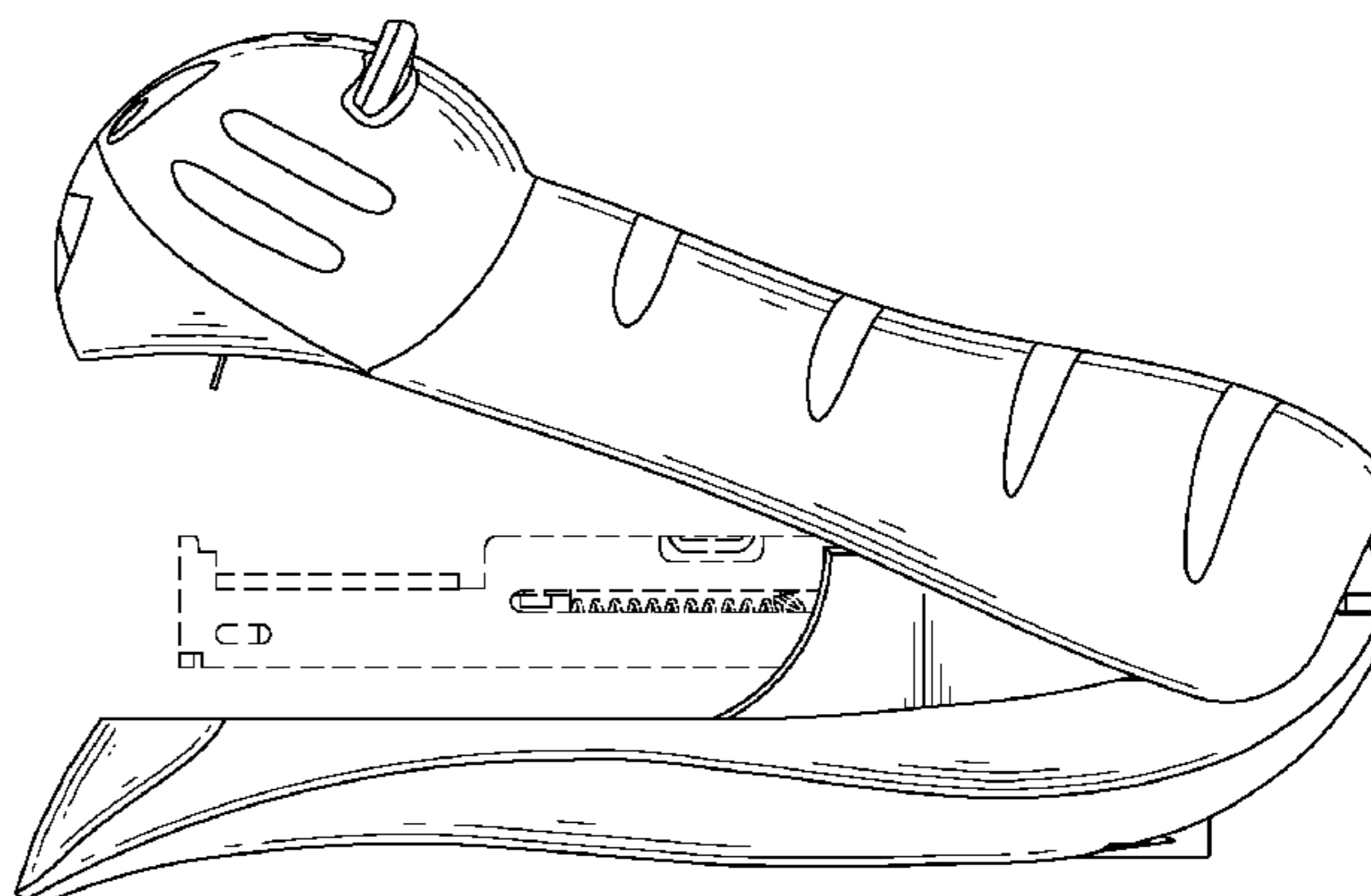
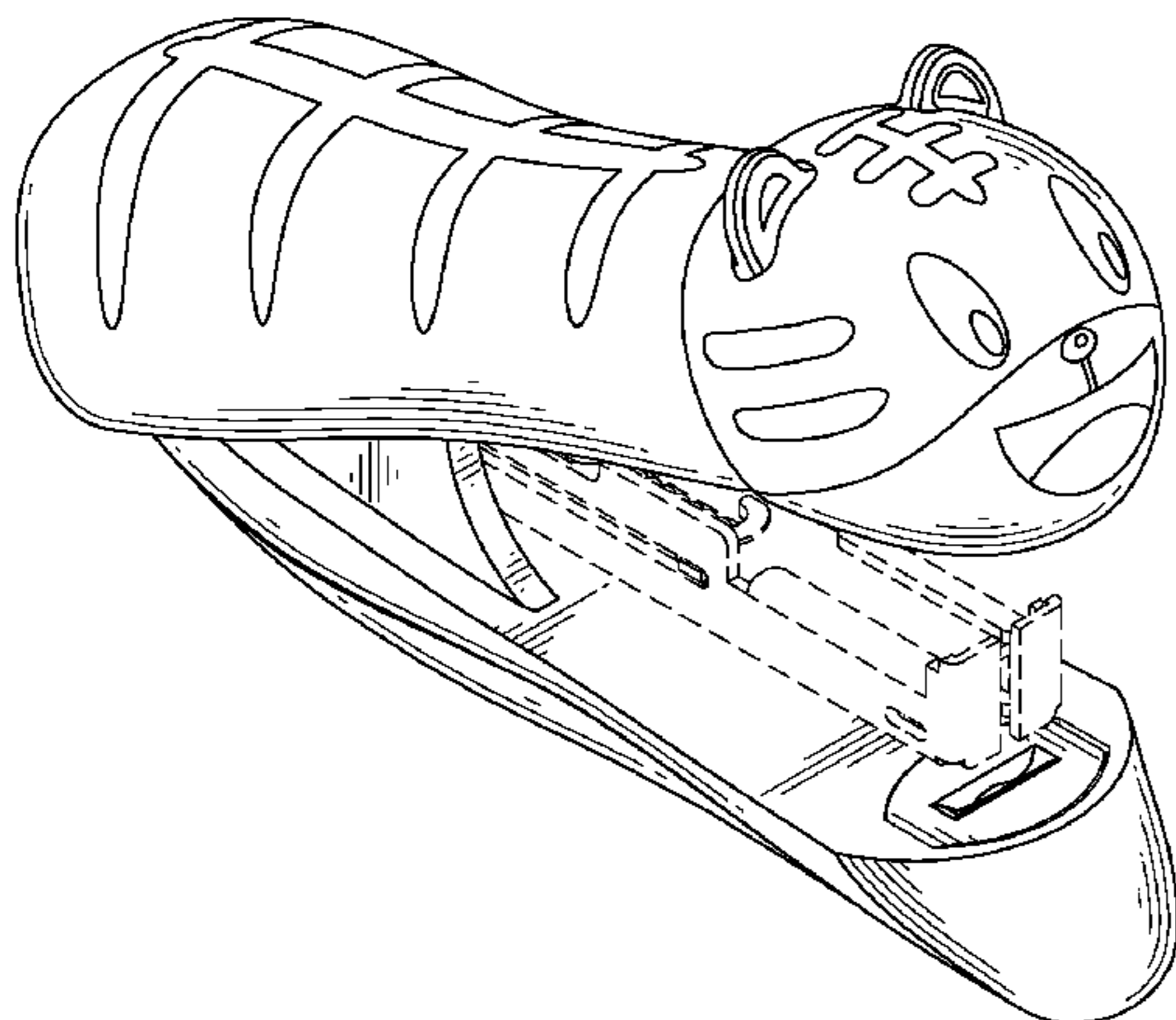

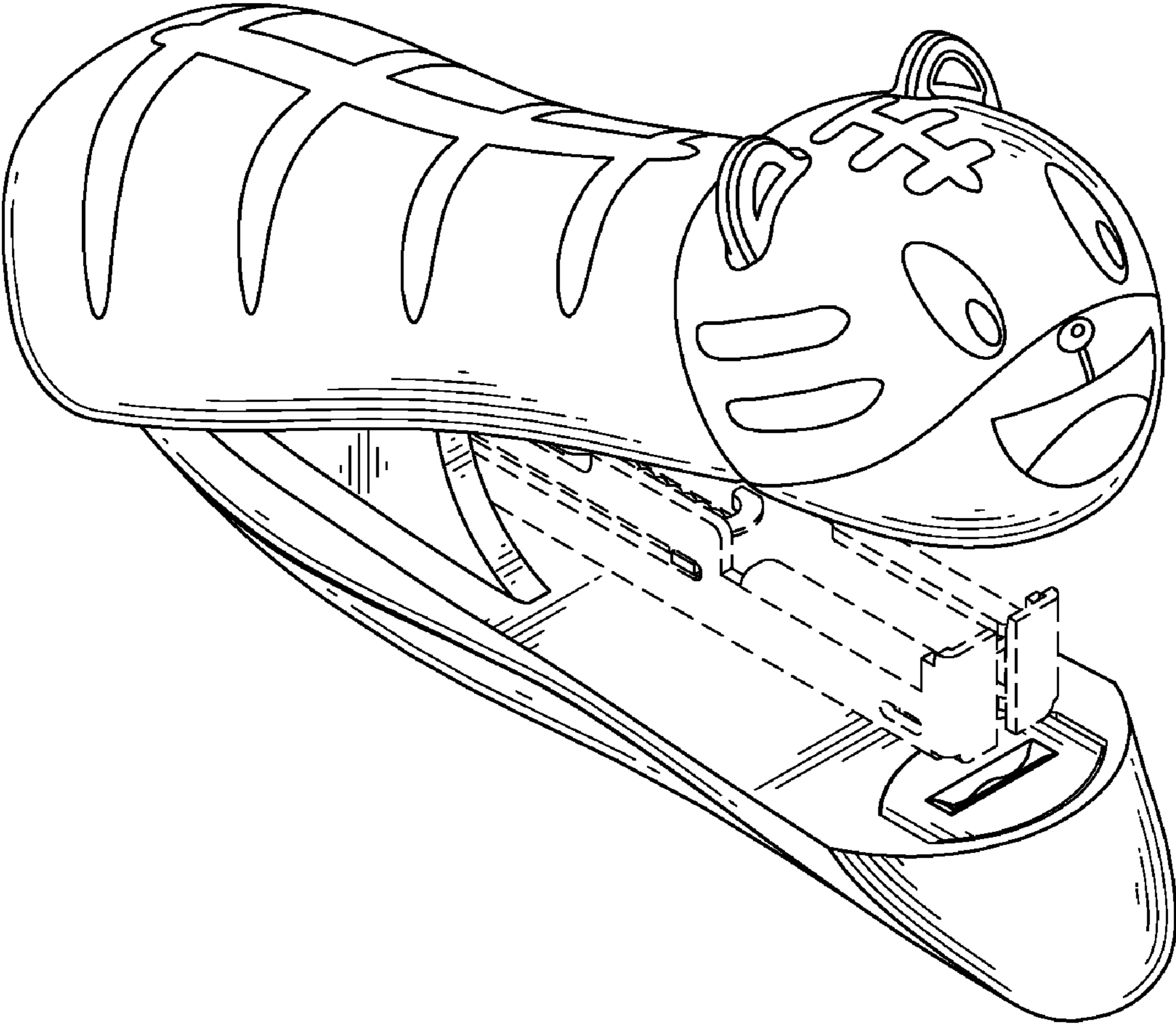

FIG. 1

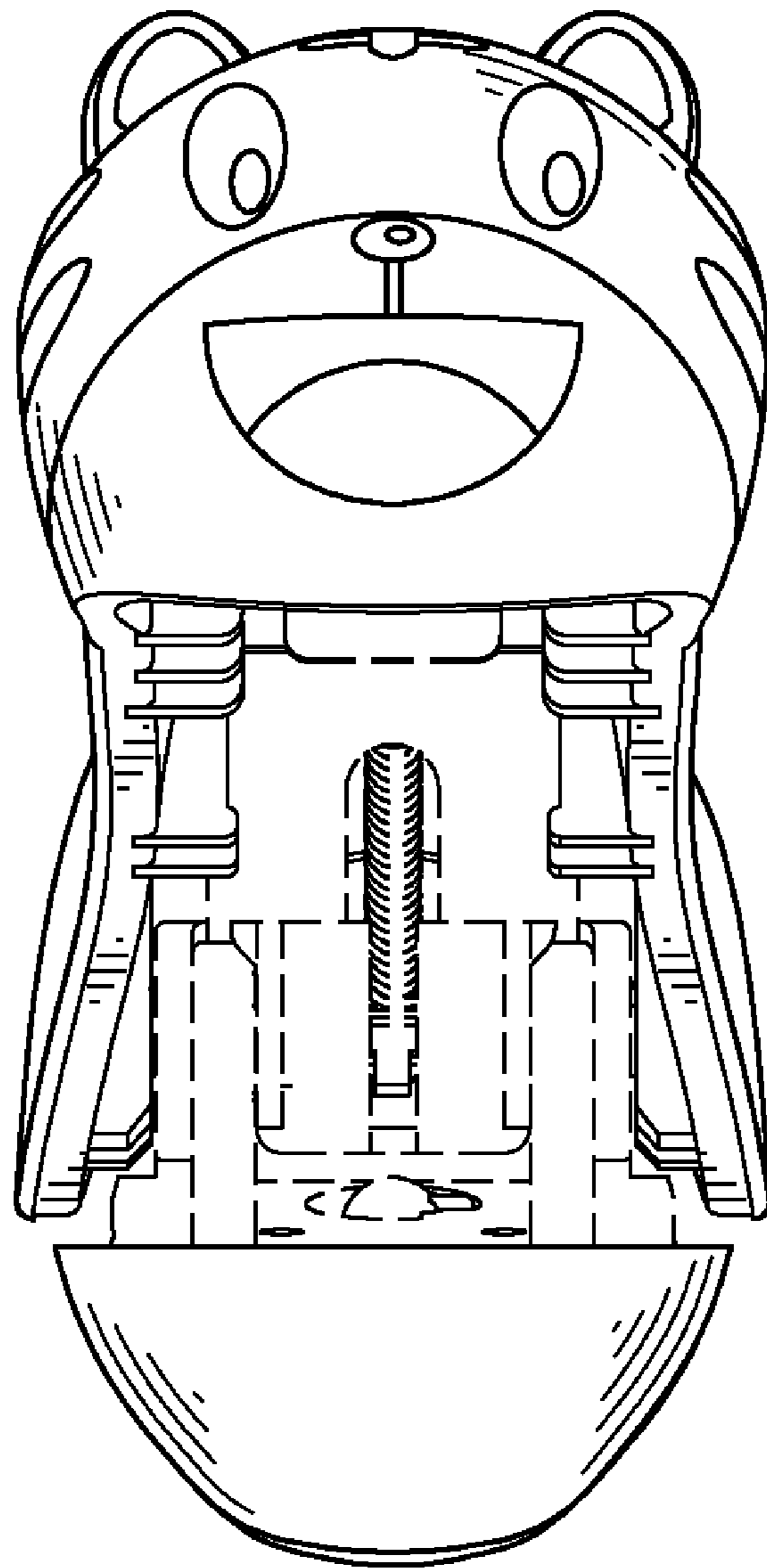

FIG. 2

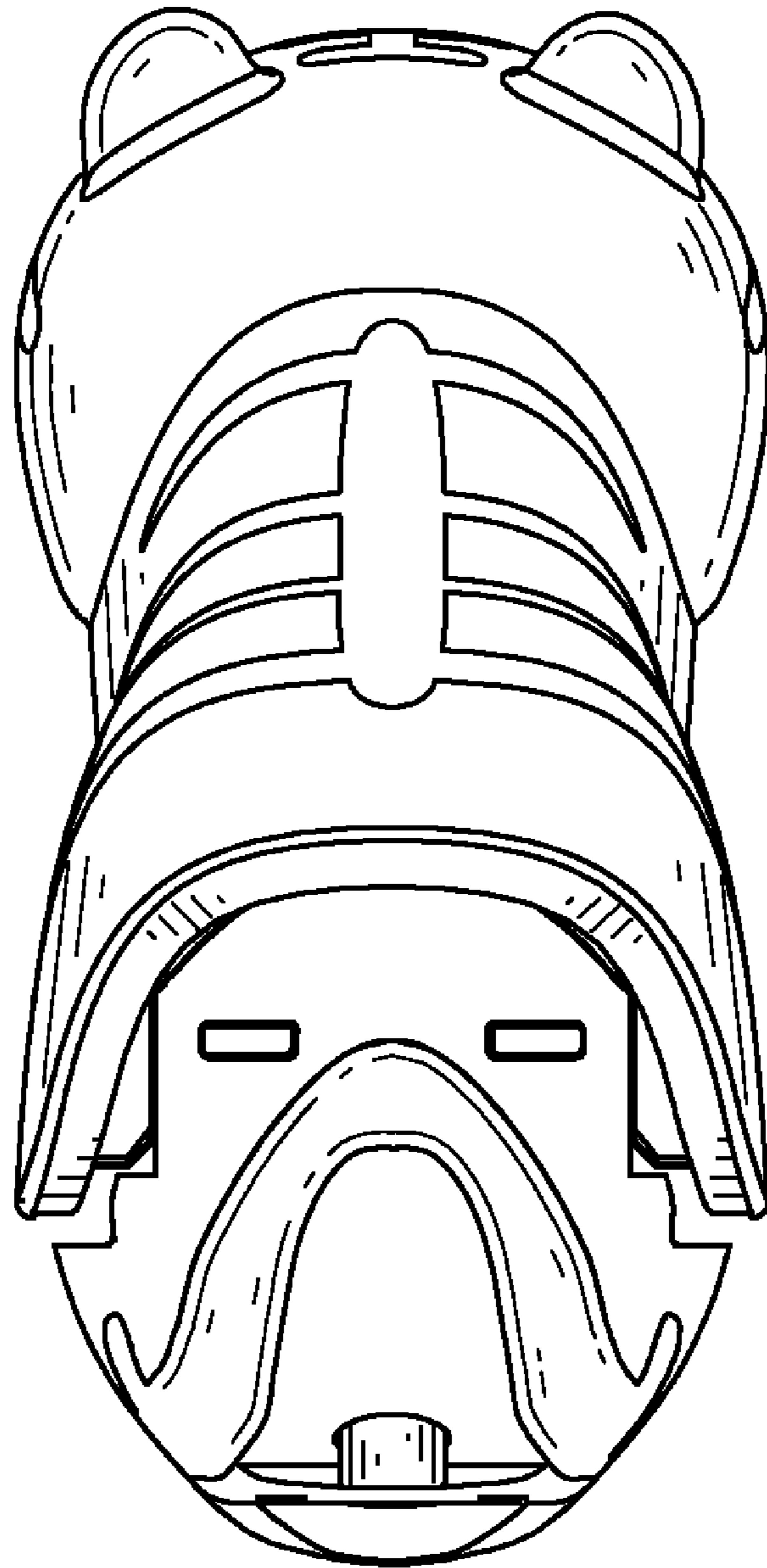

FIG. 3

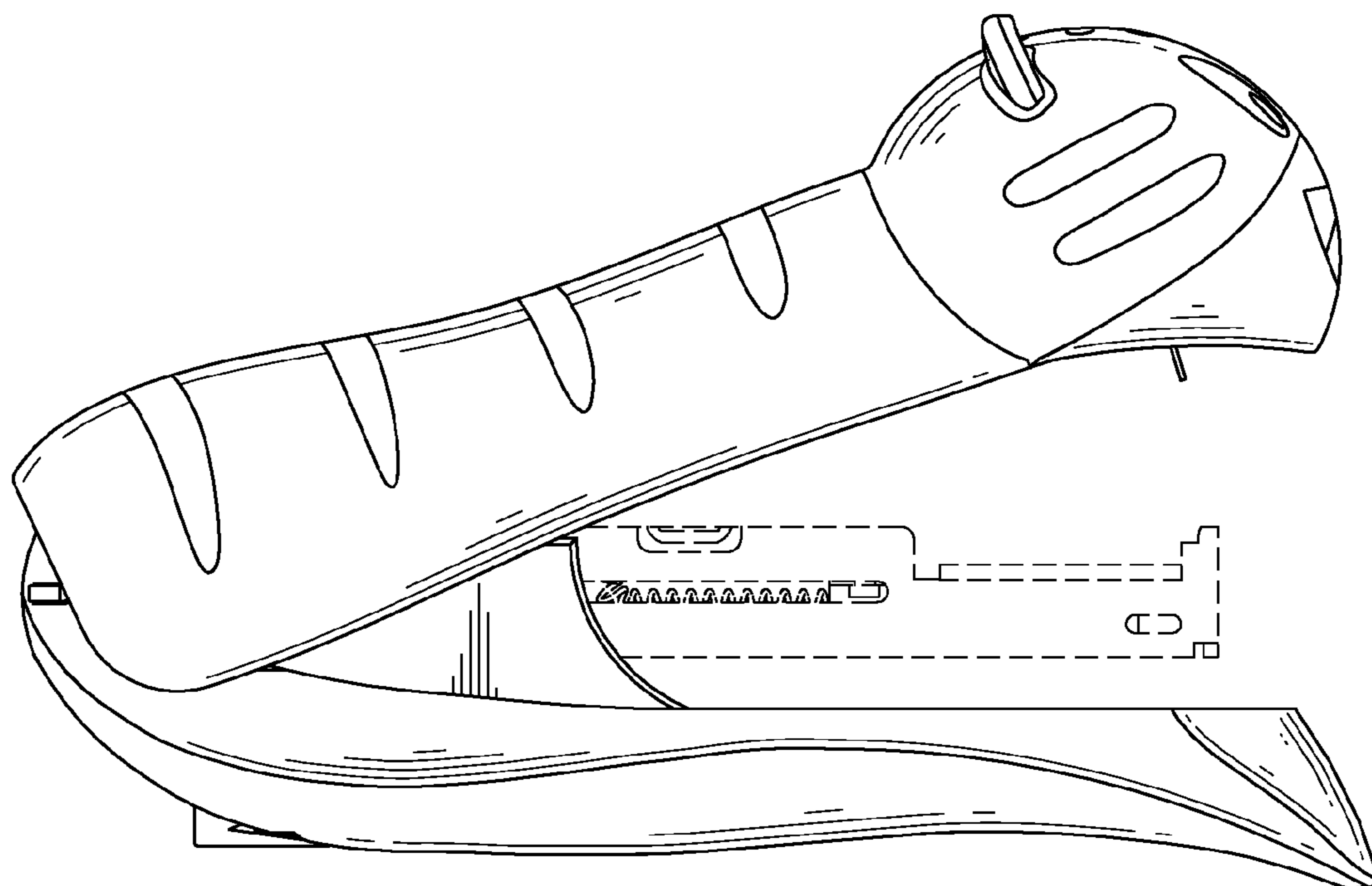

FIG. 4

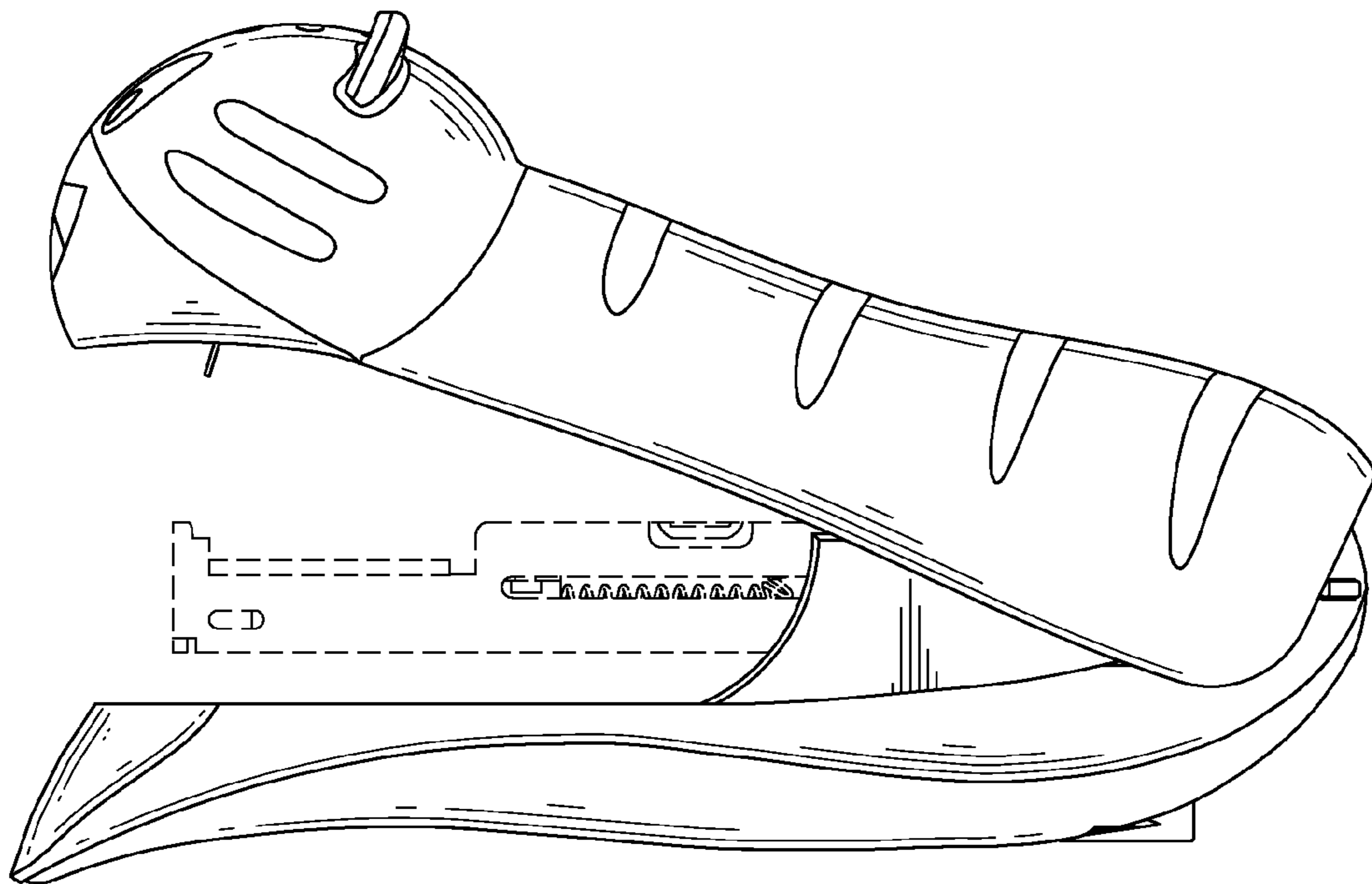

FIG. 5

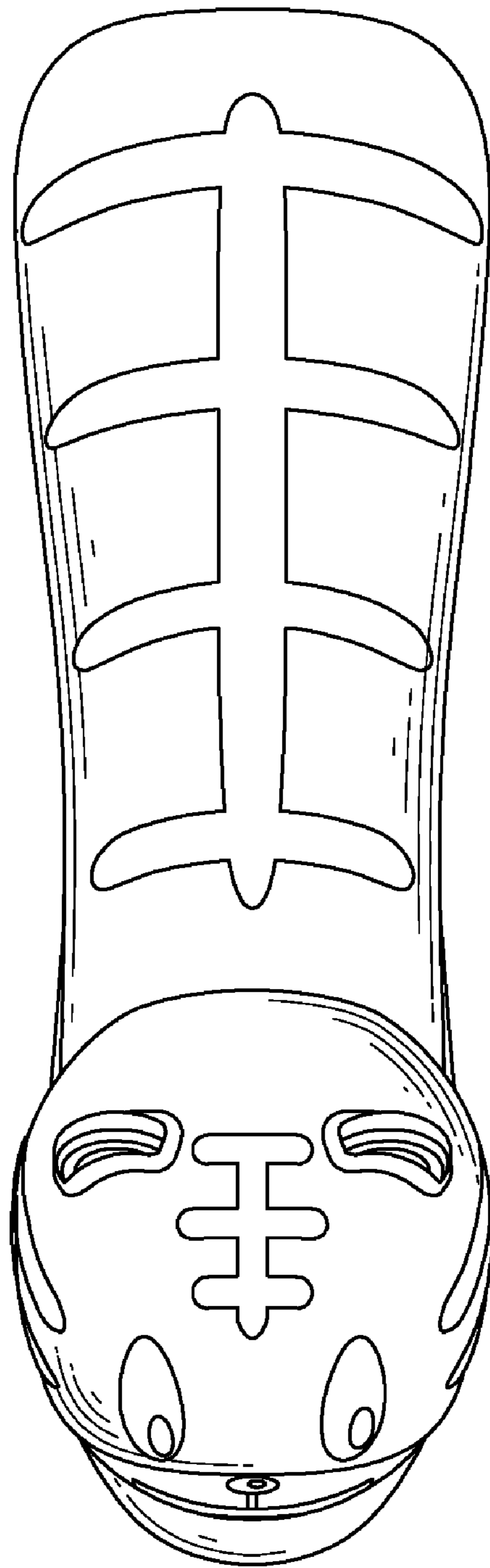

FIG. 6

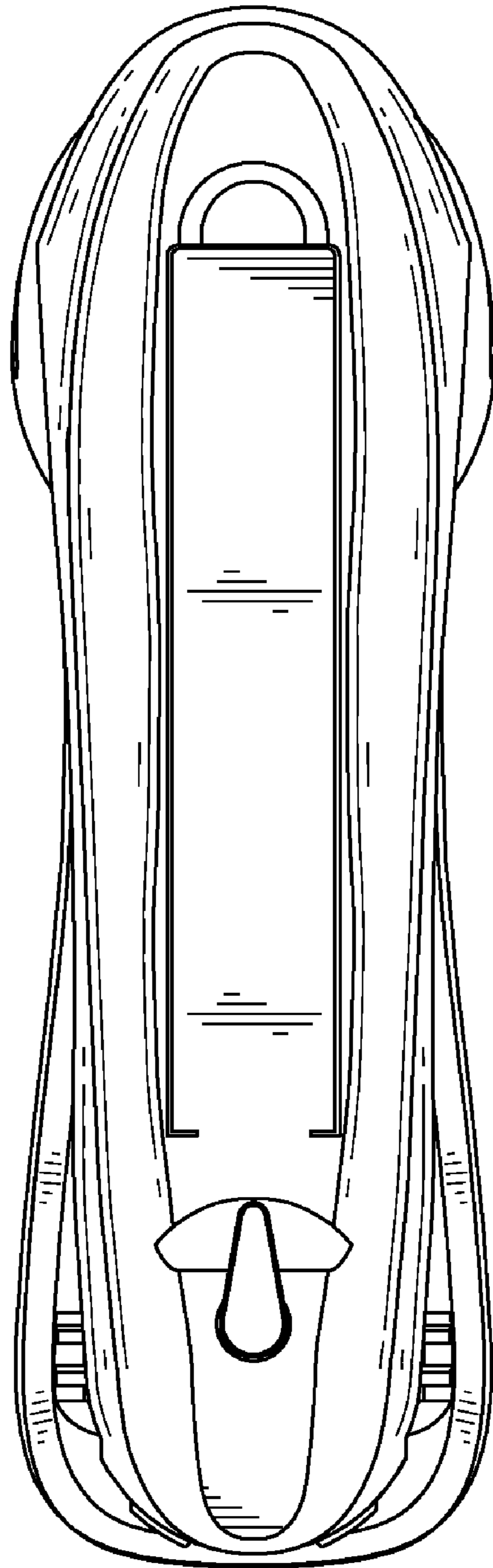

FIG. 7