



US00D638218S

(12) **United States Design Patent**
Youssefi-Shams et al.

(10) **Patent No.:** **US D638,218 S**

(45) **Date of Patent:** **** May 24, 2011**

(54) **STITCH PLATE FOR A CLIP**

(75) Inventors: **Kasra Youssefi-Shams**, Waterloo (CA);
Felipe Oliveira Simoes, Kitchener (CA)

(73) Assignee: **Research In Motion Limited**, Waterloo,
Ontario (CA)

(**) Term: **14 Years**

(21) Appl. No.: **29/336,850**

(22) Filed: **May 11, 2009**

(51) **LOC (9) Cl.** **03-01**

(52) **U.S. Cl.** **D3/318**

(58) **Field of Classification Search** D8/323,
D8/324, 363, 367, 368; 52/236.1, 236.2;
D6/579, 580, 581; 160/166.1, 176.1 R; 112/192,
112/225, 226, 227, 285, 291, 292, 295, 303,
112/308, 314, 323

See application file for complete search history.

(56) **References Cited**

U.S. PATENT DOCUMENTS

4,633,796 A * 1/1987 Hoffmann-Glewe et al. 112/314
6,276,289 B1 * 8/2001 Wahlstrom 112/292
D485,069 S * 1/2004 Parker D3/318
D507,110 S * 7/2005 Hicks et al. D3/318
D558,979 S * 1/2008 Wu et al. D3/318

7,428,876 B2 * 9/2008 Hillenbrand et al. 112/226
D581,282 S * 11/2008 Lepoitevin D9/541
D592,402 S * 5/2009 Ahlgrim et al. D3/318
D623,859 S * 9/2010 Tseng et al. D3/318

* cited by examiner

Primary Examiner — Susan Bennett Hattan

Assistant Examiner — Barbara B Lohr

(57) **CLAIM**

We claim the ornamental design for a stitch plate for a clip, as shown and described.

DESCRIPTION

FIG. 1 is a back perspective view of a stitch plate for a clip; FIG. 2 is a front perspective view of the stitch plate; FIG. 3 is a back plan view thereof; FIG. 4 is a front plan view thereof; FIG. 5 is a left elevational view thereof; FIG. 6 is a right elevational view thereof; FIG. 7 is a top plan view thereof; FIG. 8 is a bottom plan view thereof; and, FIG. 9 is another back perspective view of the stitch plate attached at one side to a clip and at the other side to a holster for a handheld electronic device.

The broken lines shown in the drawings of the stitch plate for a clip are for the purpose of illustrating portions of the article and form no part of the claimed design.

1 Claim, 7 Drawing Sheets

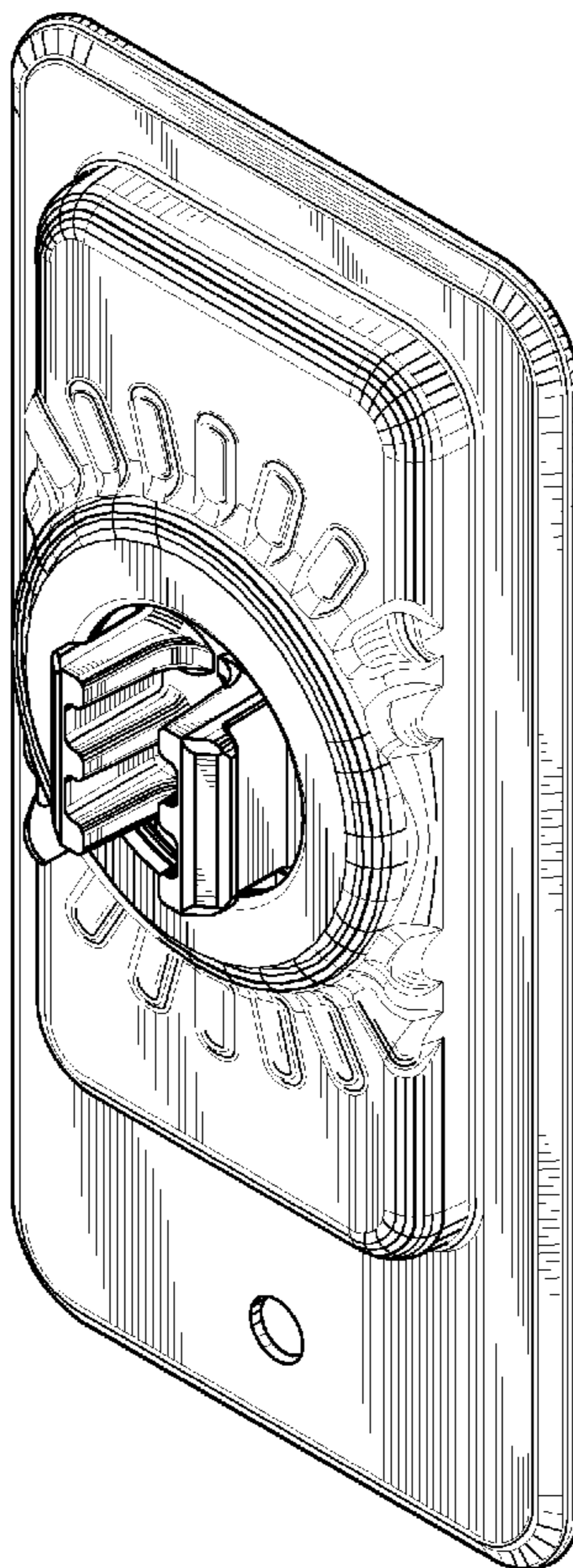

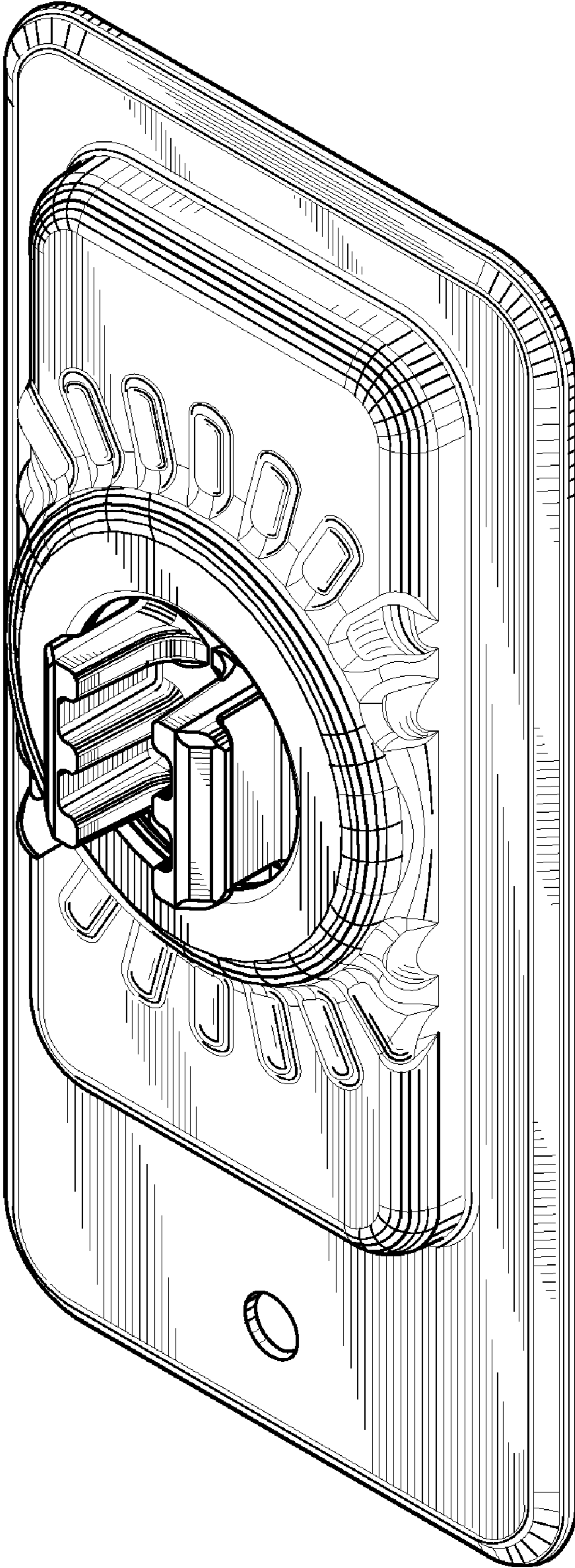

FIG.1

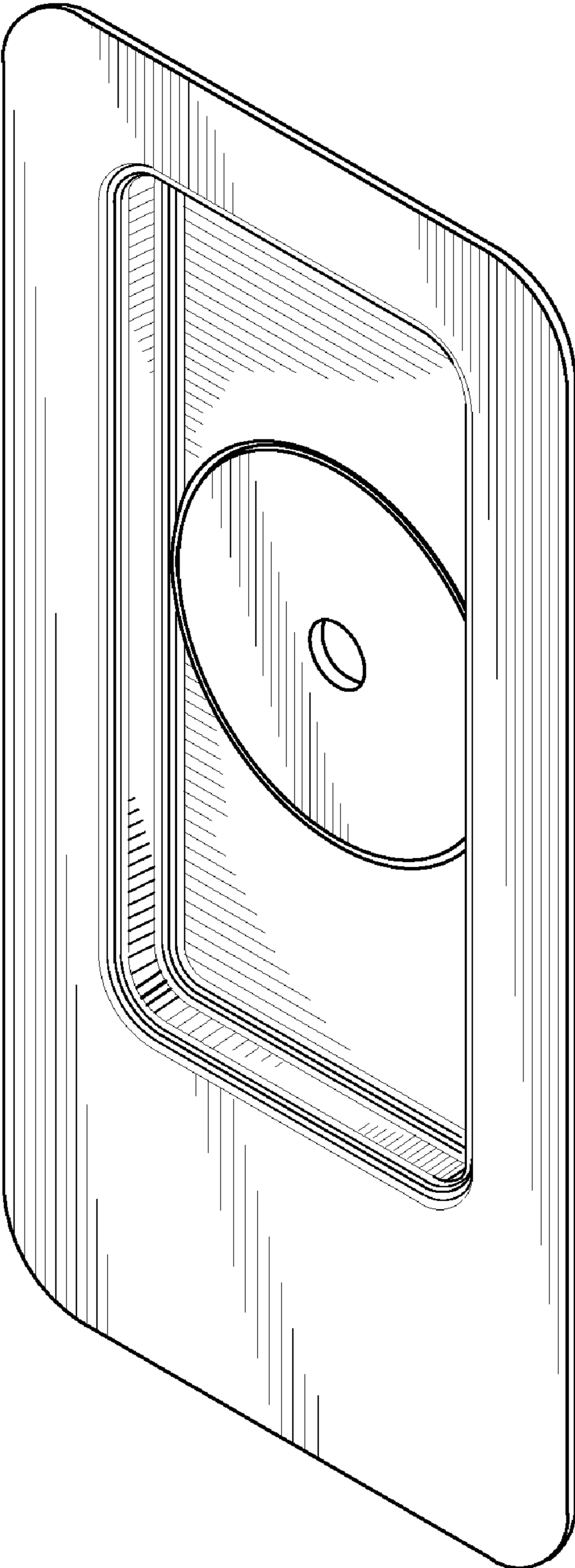

FIG.2

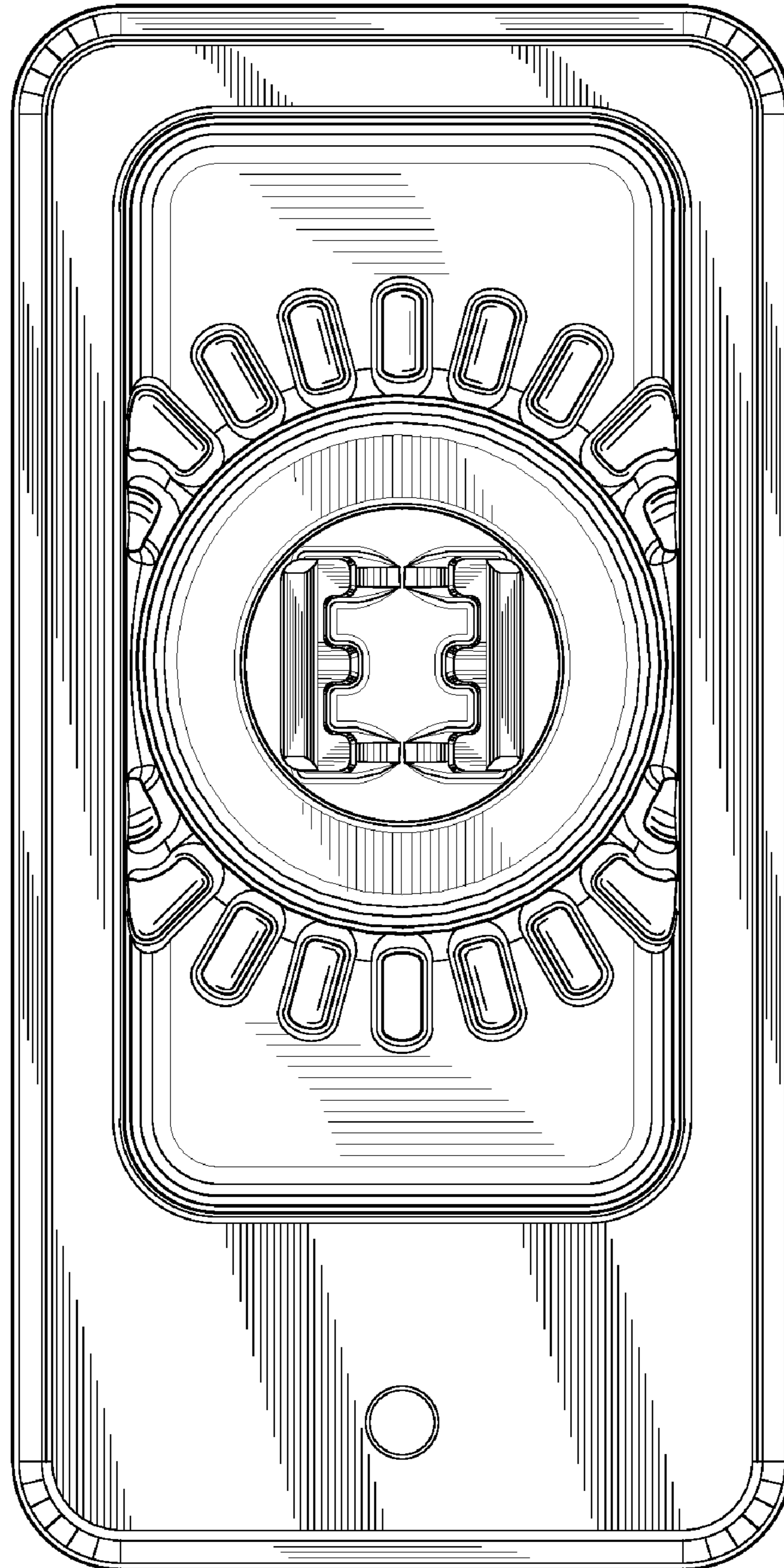

FIG.3

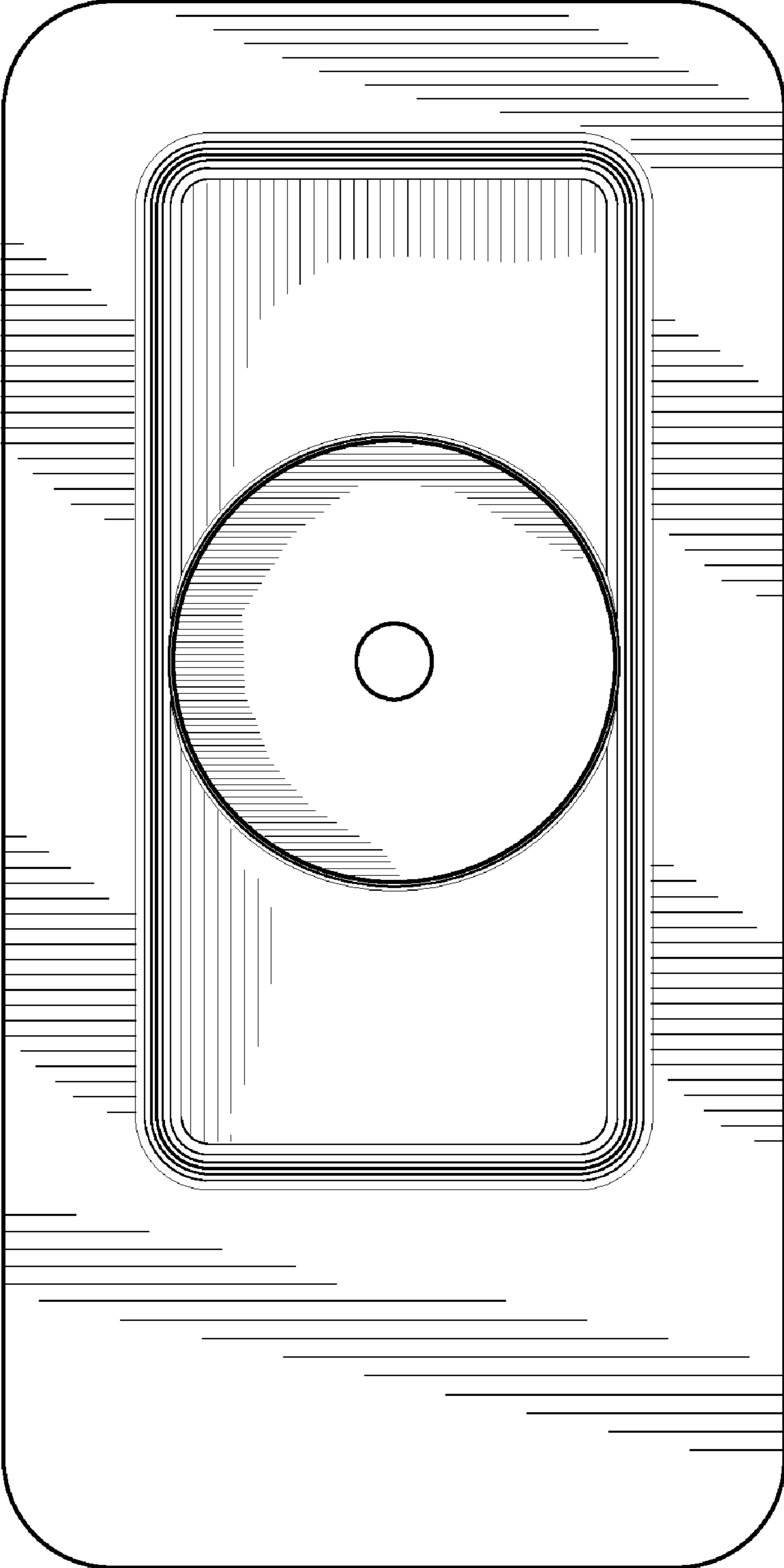

FIG.4

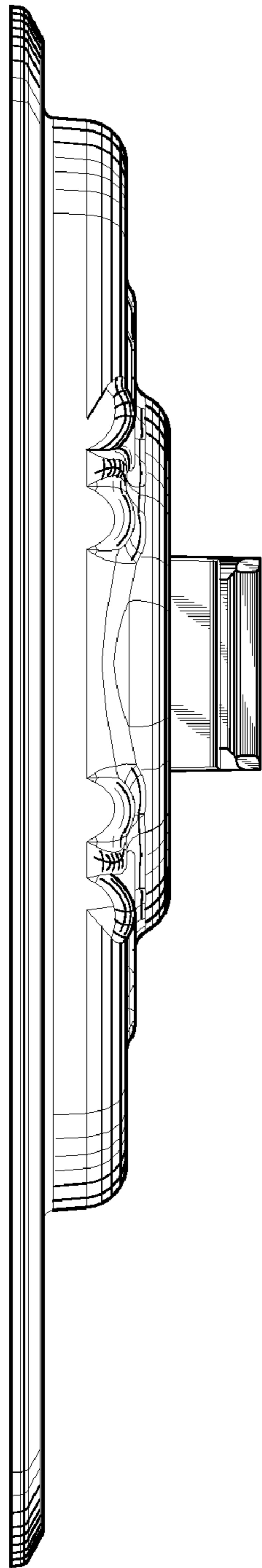

FIG. 5

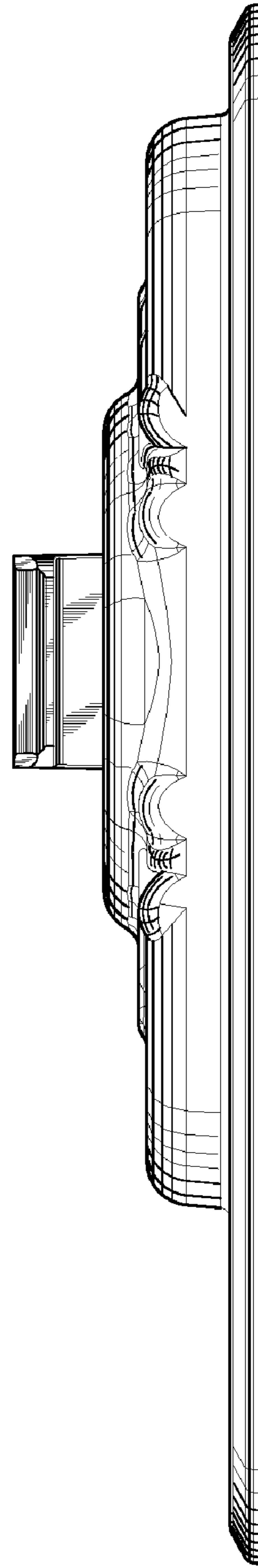

FIG. 6

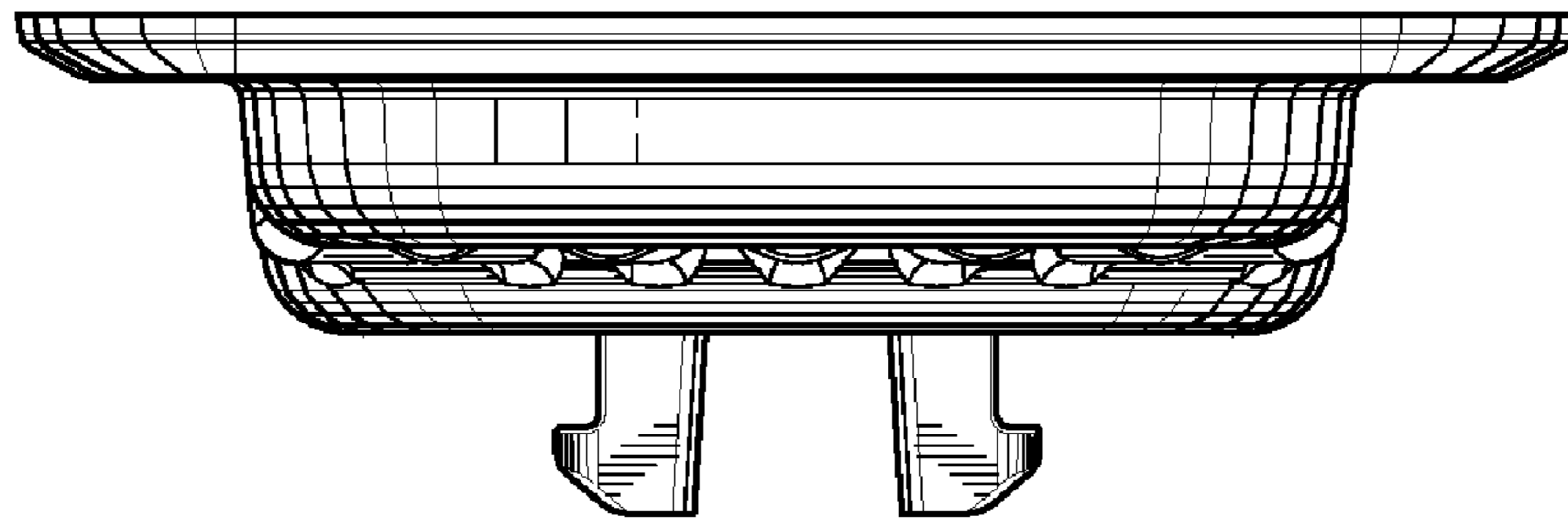

FIG. 7

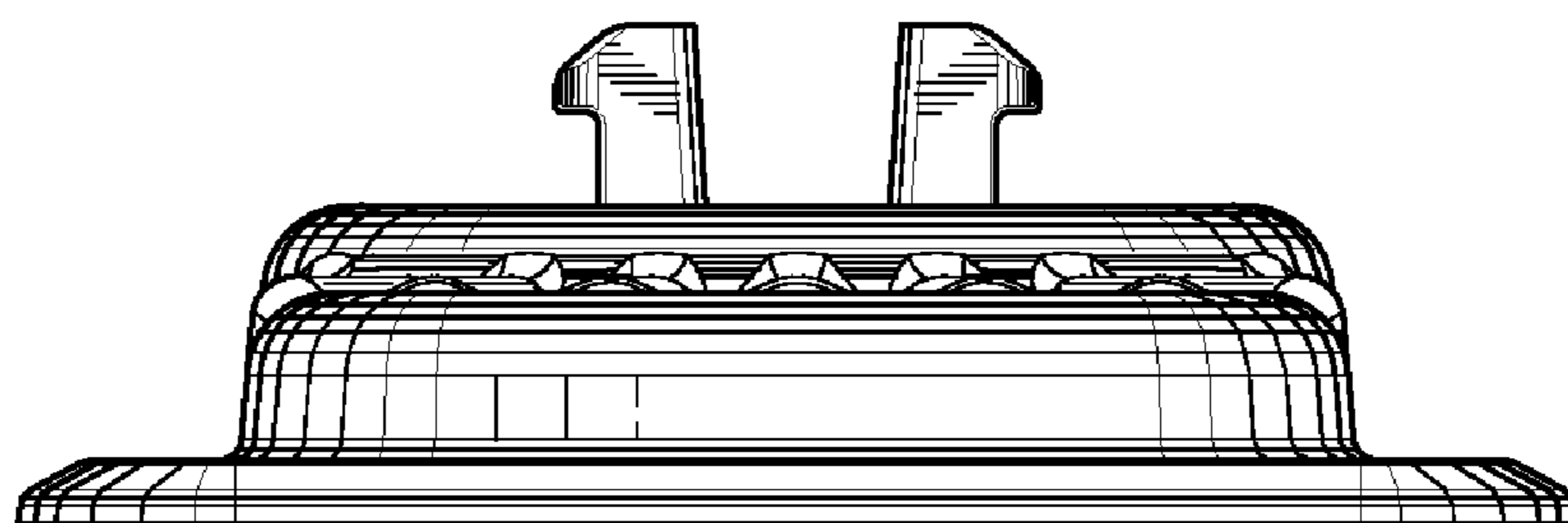

FIG. 8

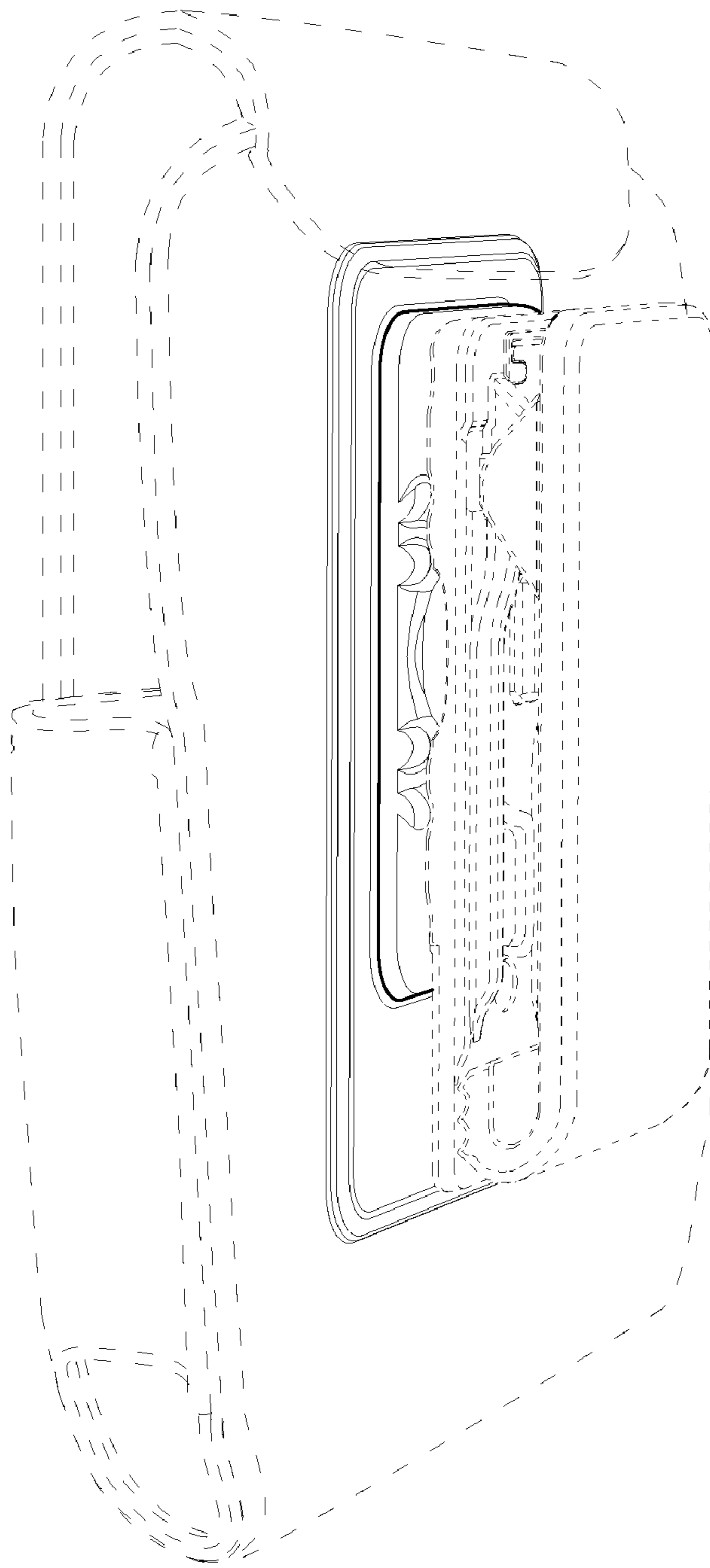

FIG.9