



US00D638189S

(12) **United States Design Patent**
Wolzen

(10) **Patent No.:** **US D638,189 S**

(45) **Date of Patent:** **** May 17, 2011**

(54) **BAGGER**

(76) Inventor: **Kent A. Wolzen**, Bettendorf, IA (US)

(**) Term: **14 Years**

(21) Appl. No.: **29/364,184**

(22) Filed: **Jun. 21, 2010**

(51) **LOC (9) Cl.** **09-09**

(52) **U.S. Cl.** **D34/5**

(58) **Field of Classification Search** D34/1-11;
248/95, 97, 99, 100, 101; D20/22, 27, 42,
D20/43; 40/672; 141/391; 294/1.1; 220/908
See application file for complete search history.

(56) **References Cited**

U.S. PATENT DOCUMENTS

| | | | | | |
|-----------|------|---------|-------------|-------|---------|
| 428,314 | A * | 5/1890 | Moseley | | 229/74 |
| D59,194 | S * | 10/1921 | Collins | | D20/22 |
| 1,663,185 | A * | 3/1928 | Webb et al. | | 40/672 |
| 1,691,090 | A * | 11/1928 | Tevander | | 40/27 |
| 4,037,778 | A * | 7/1977 | Boyle | | 141/390 |
| 4,760,982 | A * | 8/1988 | Cooke | | 248/99 |
| 4,890,652 | A * | 1/1990 | Hoerner | | 141/10 |
| 5,129,609 | A * | 7/1992 | Tobin | | 248/97 |
| 5,292,093 | A * | 3/1994 | Shumake | | 248/97 |
| 6,202,718 | B1 * | 3/2001 | Innocenti | | 141/391 |
| 6,446,918 | B1 * | 9/2002 | Knight | | 248/99 |

| | | | | | |
|--------------|------|--------|--------------|-------|---------|
| 6,536,488 | B1 * | 3/2003 | Pochobradsky | | 141/390 |
| D523,604 | S * | 6/2006 | Wiley | | D34/6 |
| D567,464 | S * | 4/2008 | Dullum | | D34/6 |
| 7,367,600 | B1 * | 5/2008 | Lew et al. | | 294/1.1 |
| D591,794 | S * | 5/2009 | Laass | | D19/59 |
| D593,721 | S * | 6/2009 | Koll | | D34/5 |
| 2008/0023595 | A1 * | 1/2008 | Armaly, Jr. | | 248/97 |
| 2010/0237202 | A1 * | 9/2010 | Minicozzi | | 248/97 |

* cited by examiner

Primary Examiner — Cynthia E Ramirez

(74) *Attorney, Agent, or Firm* — Hamilton IP Law, PC.; Jay R. Hamilton; Charles A. Damschen

(57) **CLAIM**

The ornamental design for a bagger, as shown and described.

DESCRIPTION

FIG. 1 is a front perspective view of a bagger showing our new design;

FIG. 2 is a side perspective view thereof;

FIG. 3 is a right side view thereof;

FIG. 4 is an end view thereof;

FIG. 5 is a top perspective view with the sides extended out thereof; and,

FIG. 6 is a top side view thereof.

The broken lines in the Figures are for illustrative purposes only and form no part of the claimed design.

1 Claim, 6 Drawing Sheets

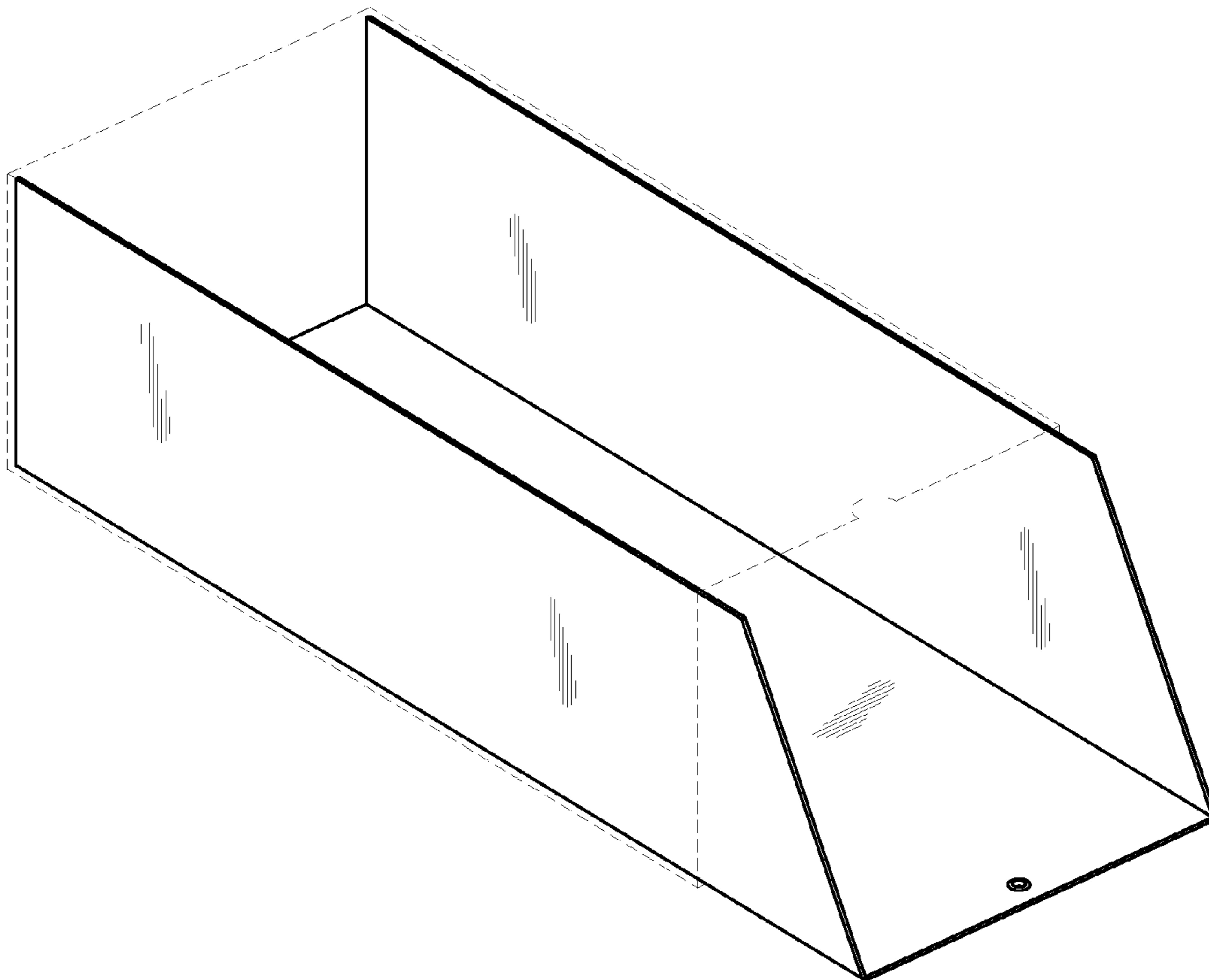

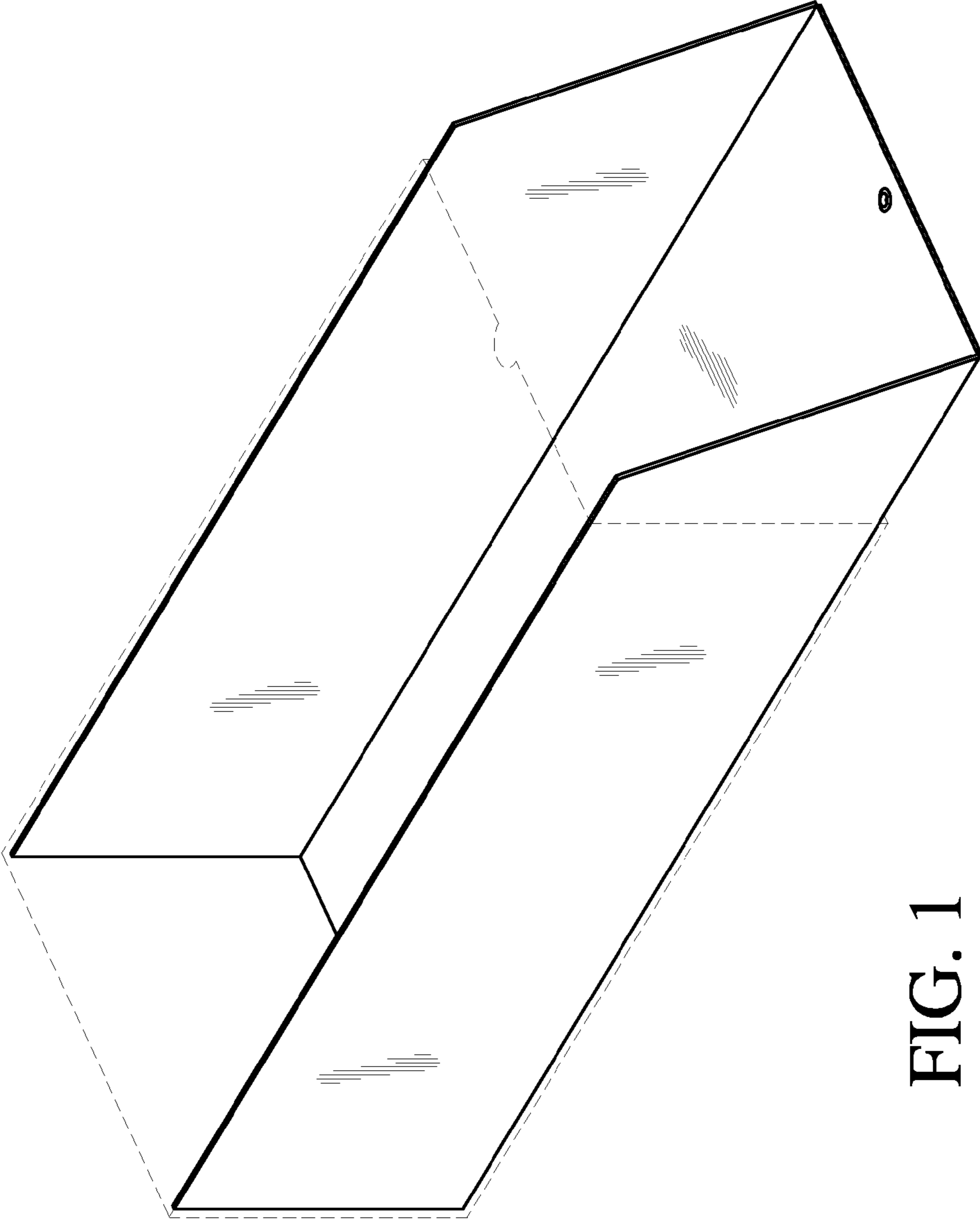

FIG. 1

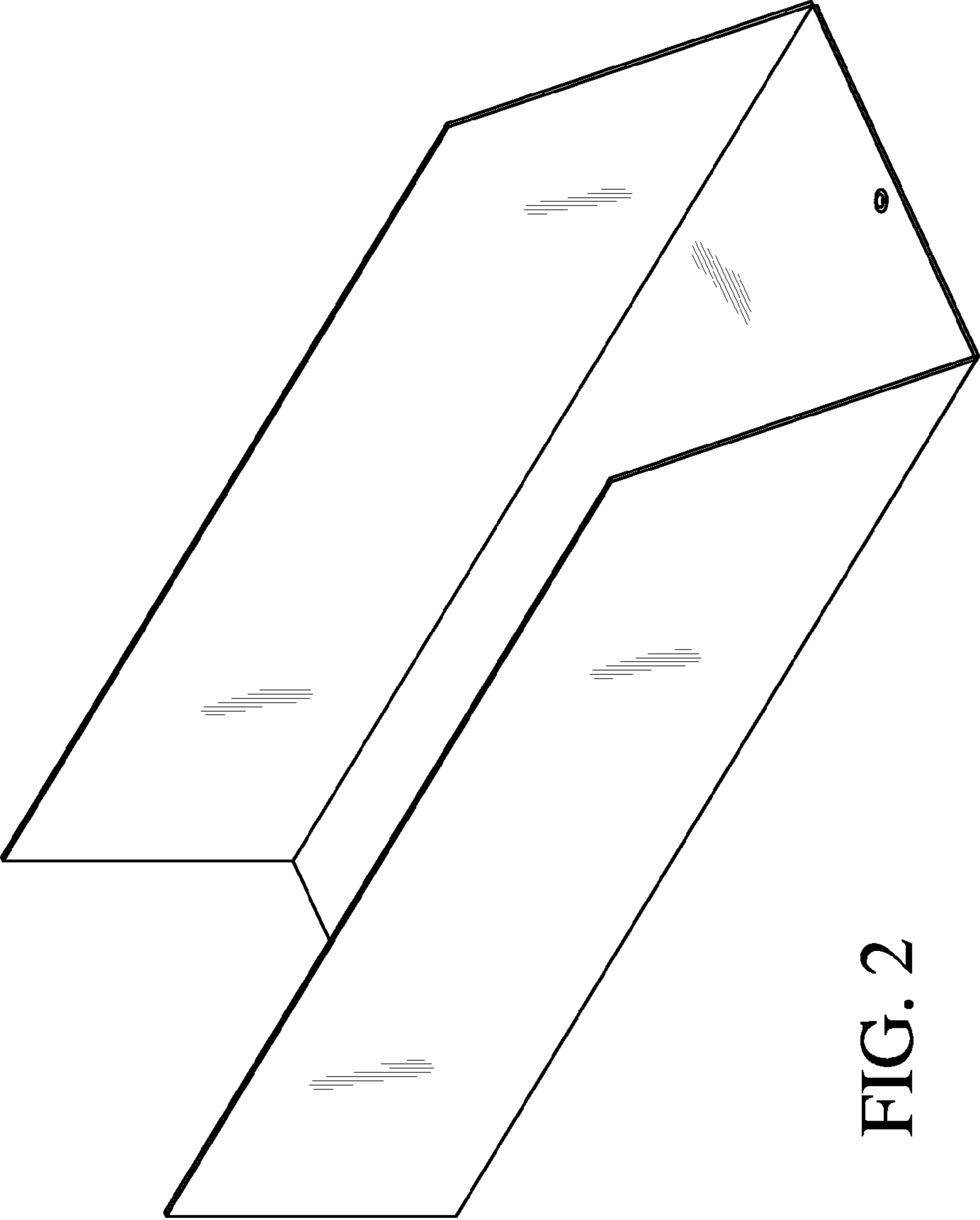

FIG. 2

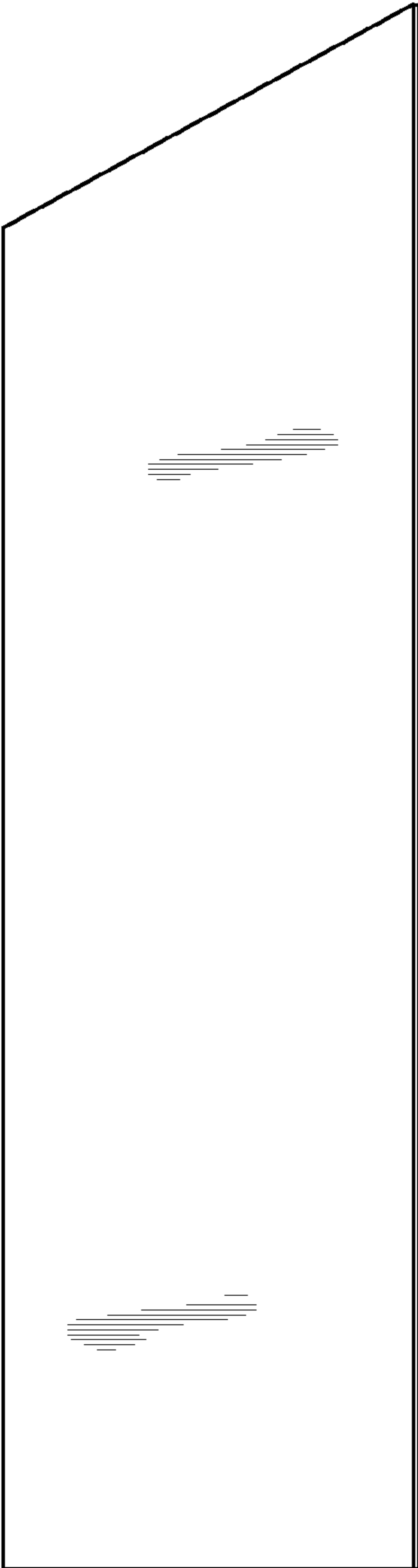

FIG. 3

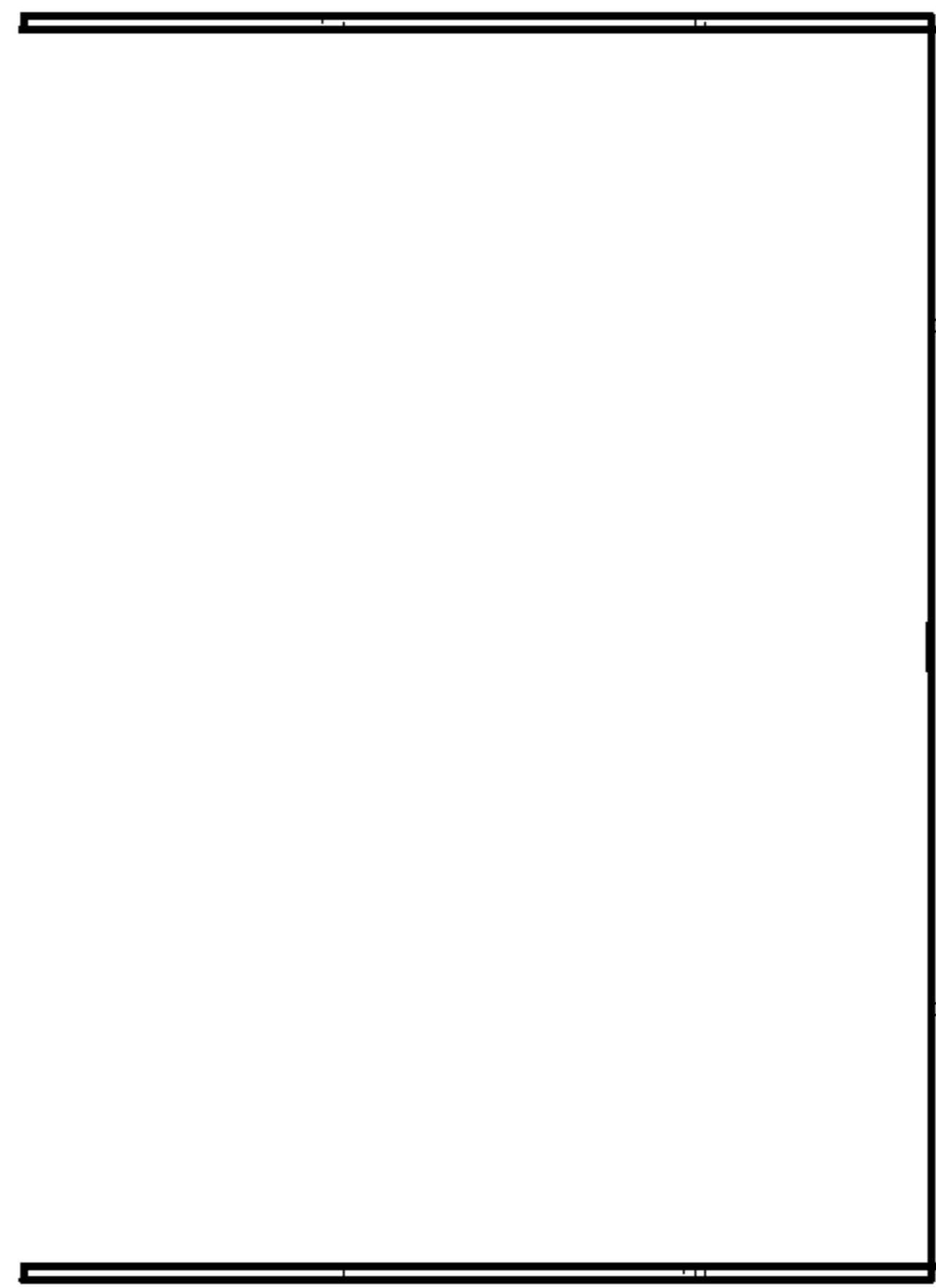

FIG. 4

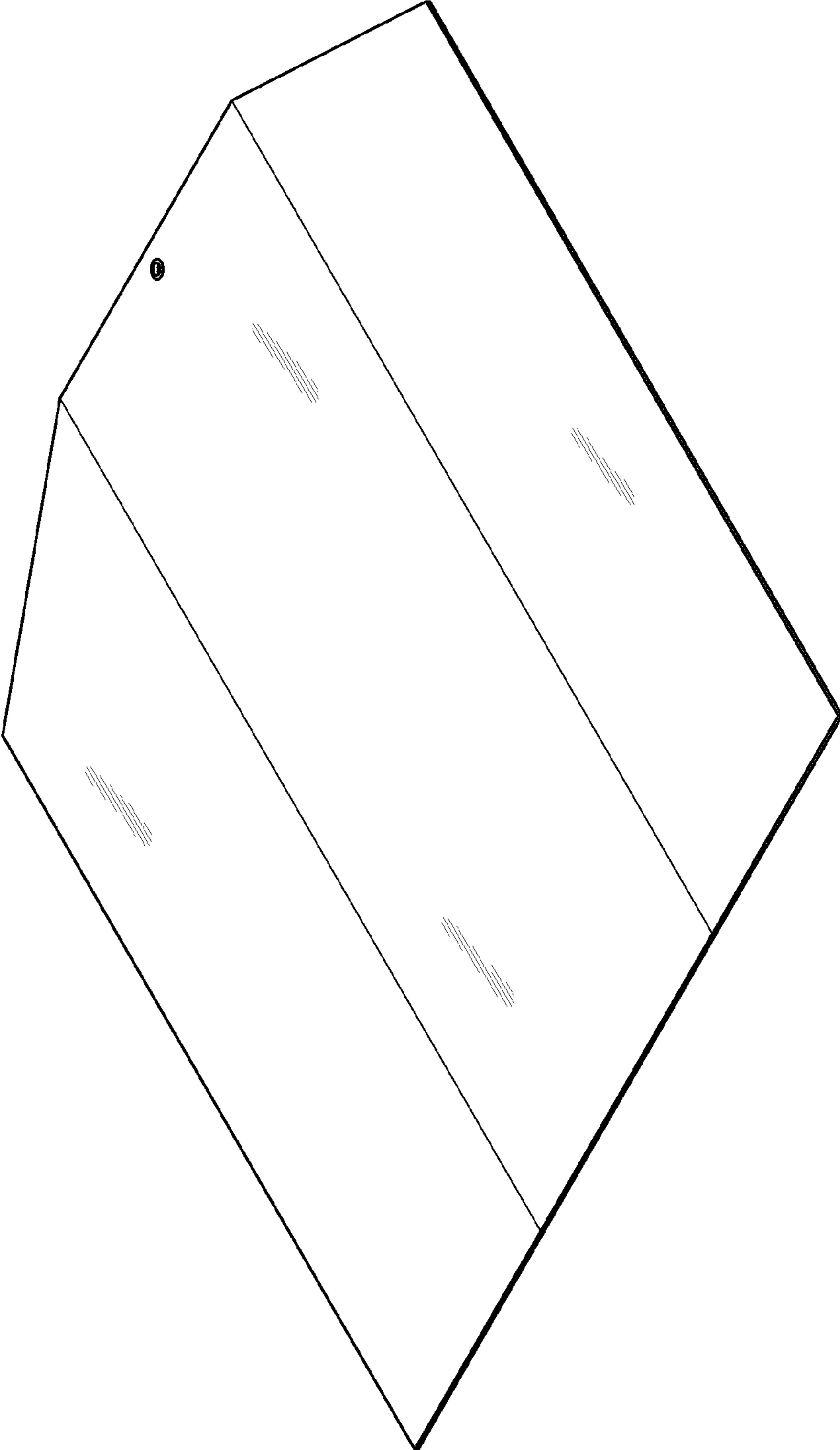

FIG. 5

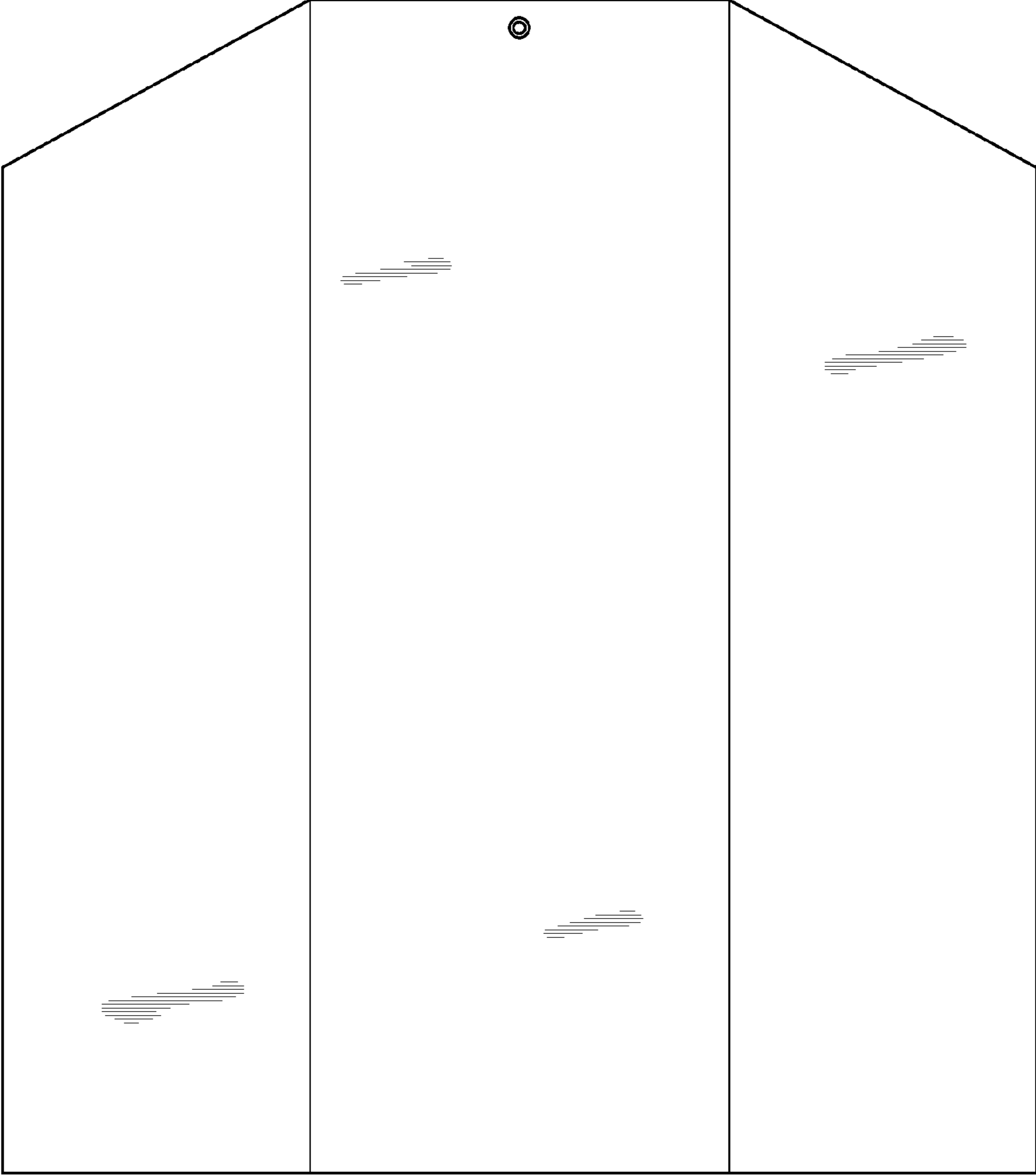

FIG. 6