



US00D638140S

(12) **United States Design Patent**
Busschaert et al.

(10) **Patent No.:** **US D638,140 S**
(45) **Date of Patent:** **** May 17, 2011**

(54) **SAW HORSE COMBINATION**

(75) Inventors: **Jason F. Busschaert**, Bel Air, MD (US);
James A. Downing, Owings Mills, MD
(US); **Torrey R. Lambert**, Baltimore,
MD (US)

(73) Assignee: **Black & Decker Inc.**, Newark, DE (US)

(**) Term: **14 Years**

(21) Appl. No.: **29/378,544**

(22) Filed: **Nov. 5, 2010**

(51) **LOC (9) Cl.** **25-04**

(52) **U.S. Cl.** **D25/67**

(58) **Field of Classification Search** D25/67;
182/181.1, 186.5, 224

See application file for complete search history.

(56) **References Cited**

U.S. PATENT DOCUMENTS

D279,606 S * 7/1985 Merians D25/67
4,703,830 A * 11/1987 Parker 182/151
D306,349 S * 2/1990 Logan, Jr. D25/67
6,827,181 B2 * 12/2004 Austin et al. 182/186.6

* cited by examiner

Primary Examiner — Doris Clark

(74) *Attorney, Agent, or Firm* — Adan Ayala

(57) **CLAIM**

The ornamental design for a saw horse combination, as shown and described.

DESCRIPTION

FIG. 1 is a perspective view of a saw horse combination according to the invention.

FIG. 2 is a right side view of the saw horse combination.

FIG. 3 is a left side view of the saw horse combination.

FIG. 4 is a rear elevational view of the saw horse combination.

FIG. 5 is a front elevational view of the saw horse combination.

FIG. 6 is a top plan view of the saw horse combination; and, FIG. 7 is a bottom plan view of the saw horse combination.

1 Claim, 6 Drawing Sheets

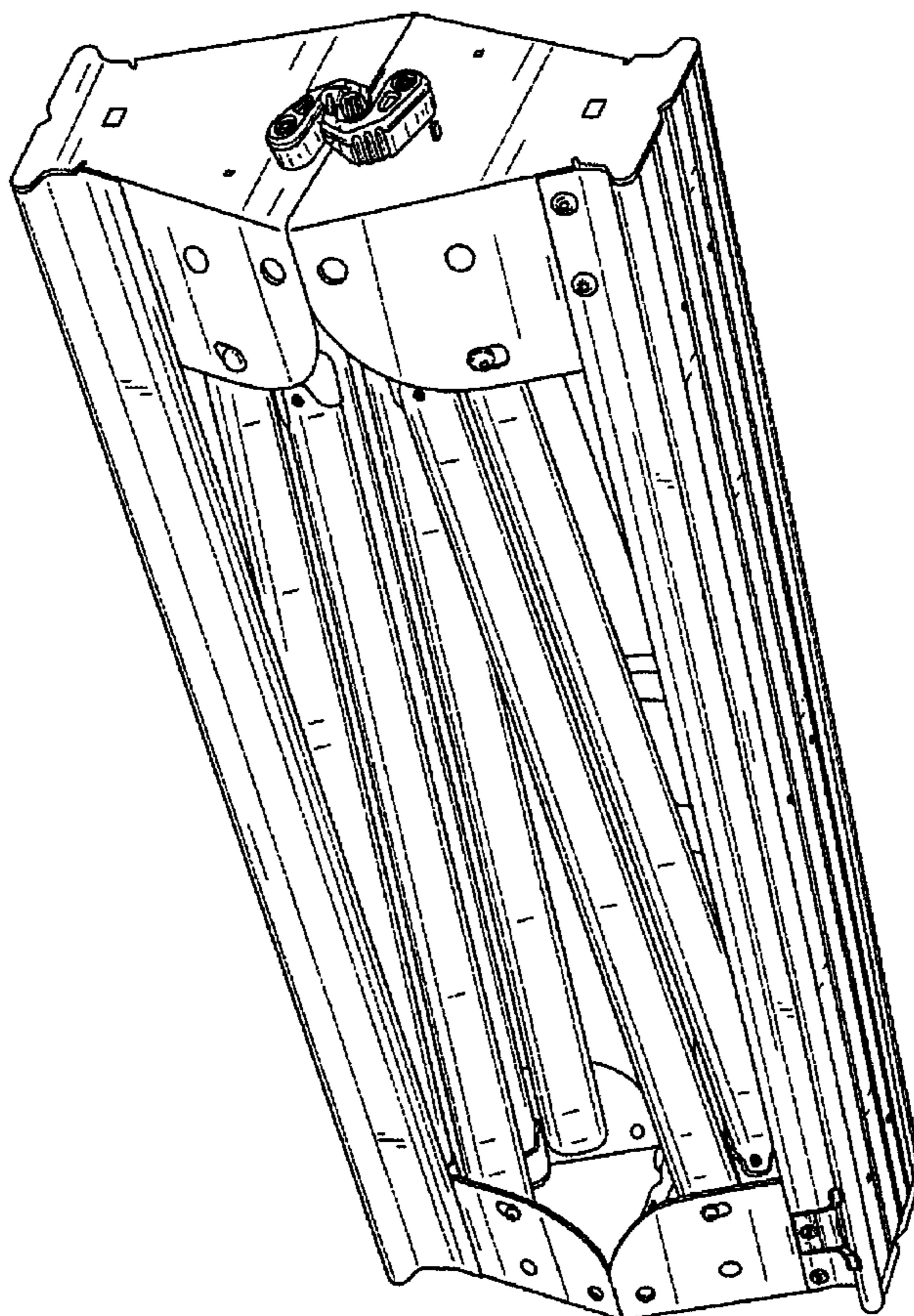

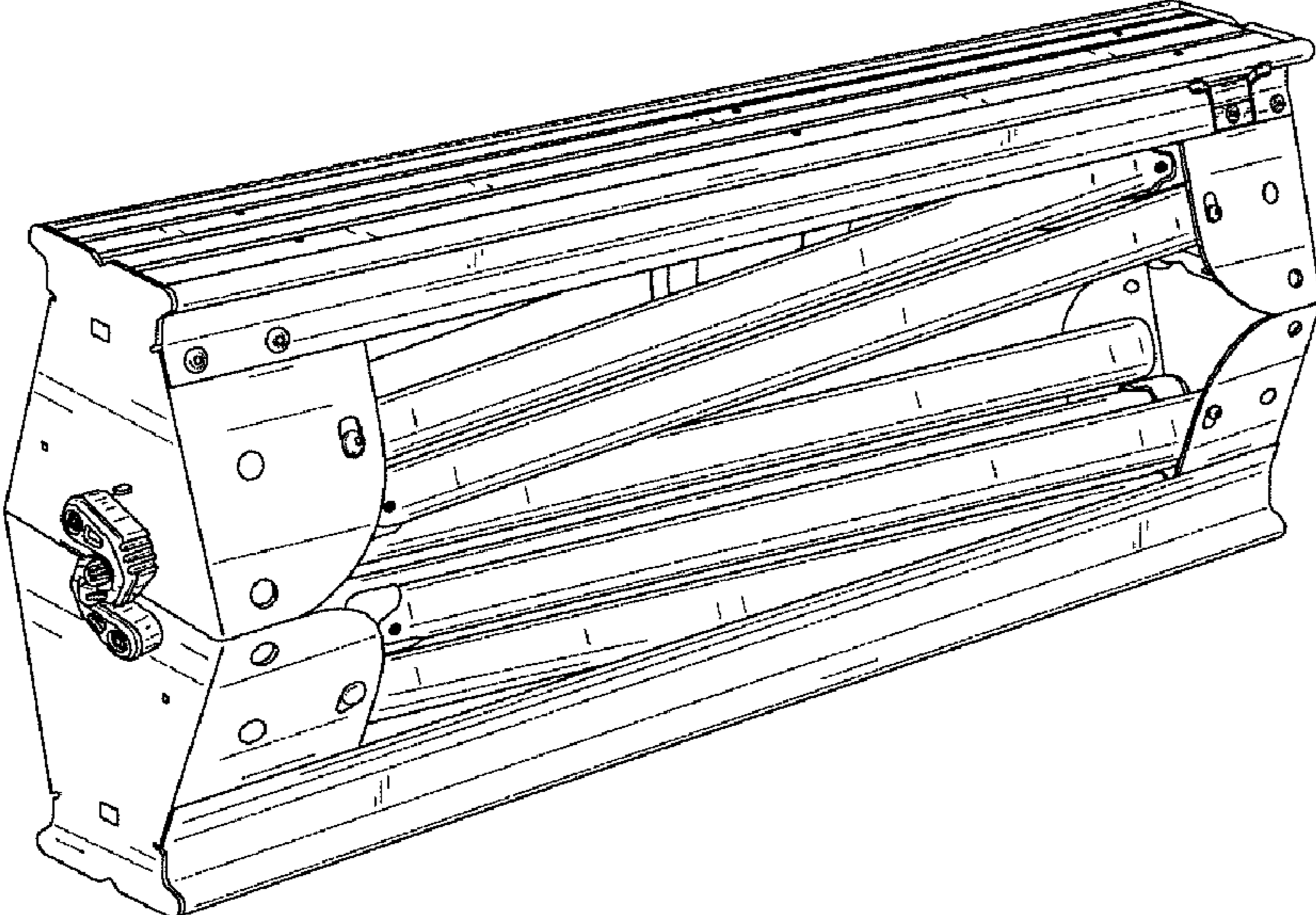

FIG. 1

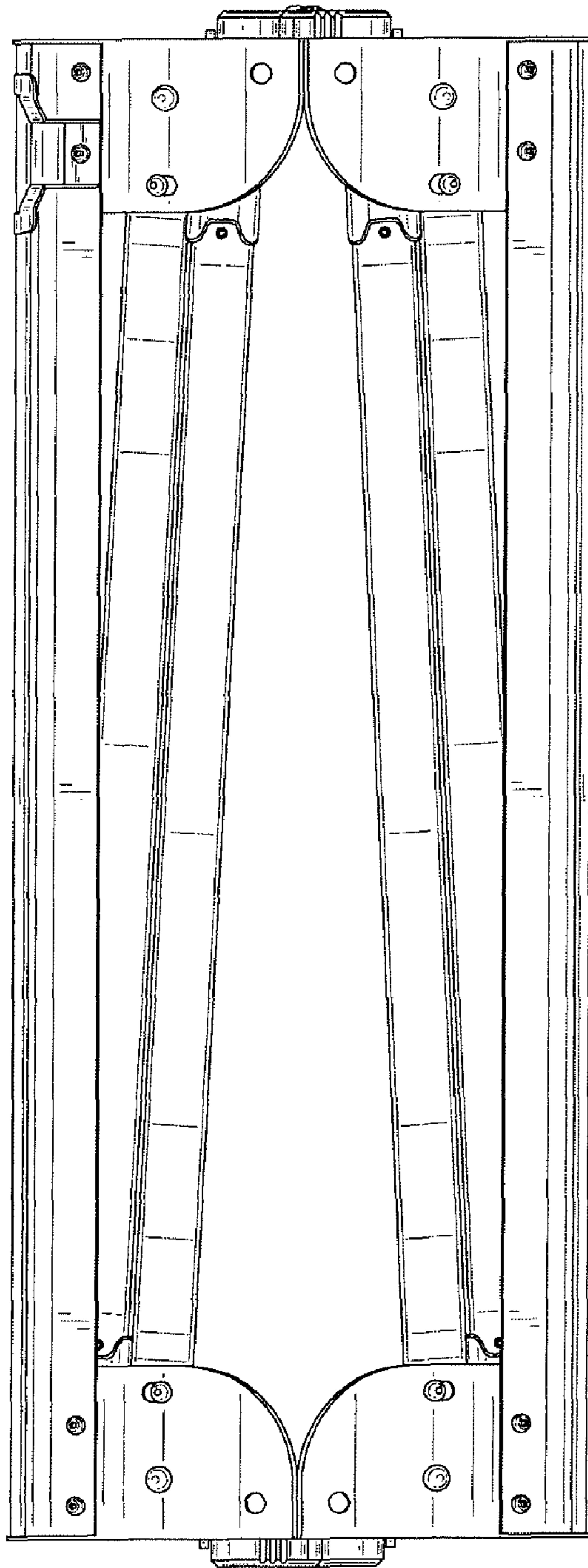

FIG. 2

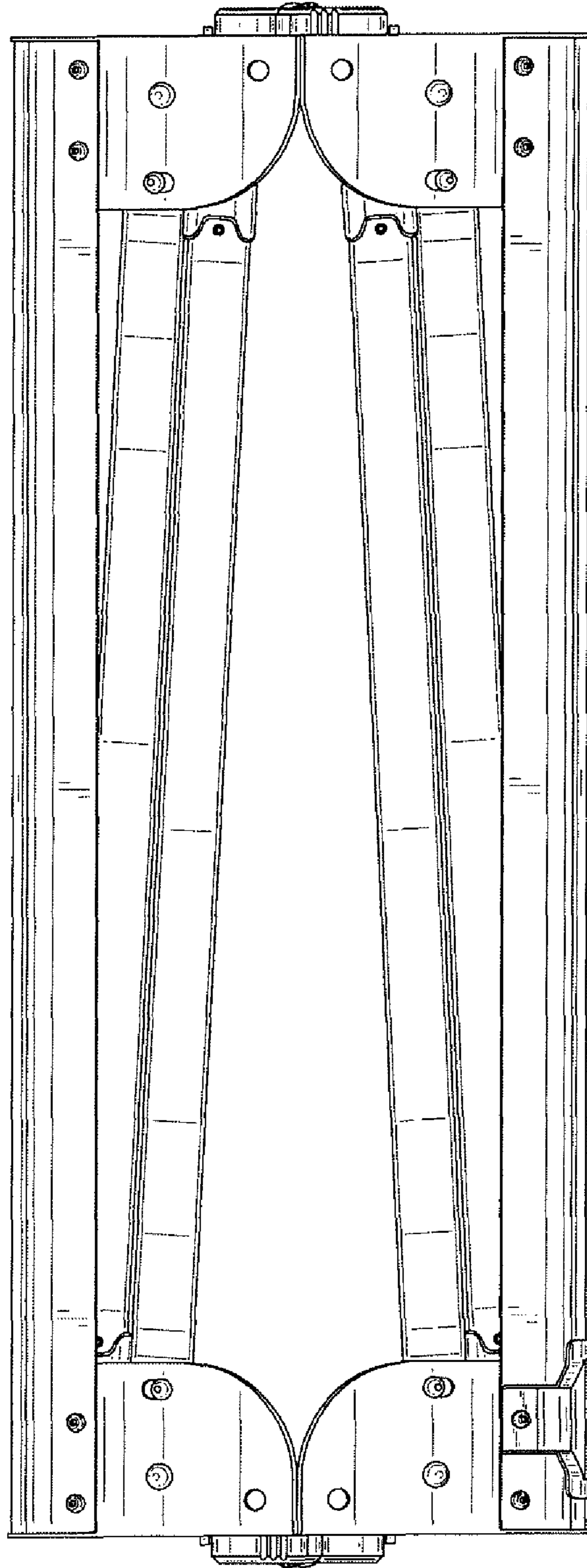

FIG. 3

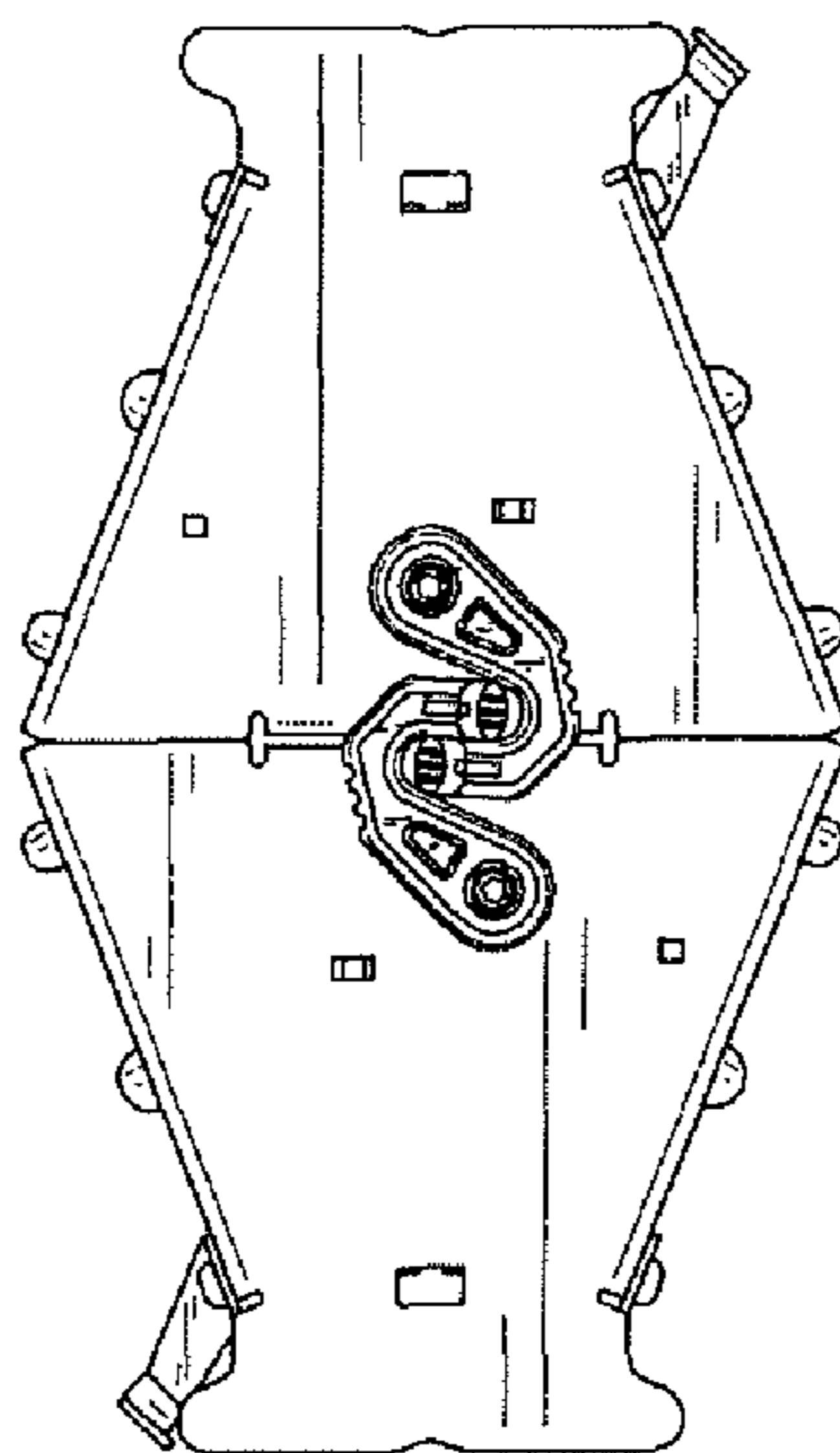

FIG. 4

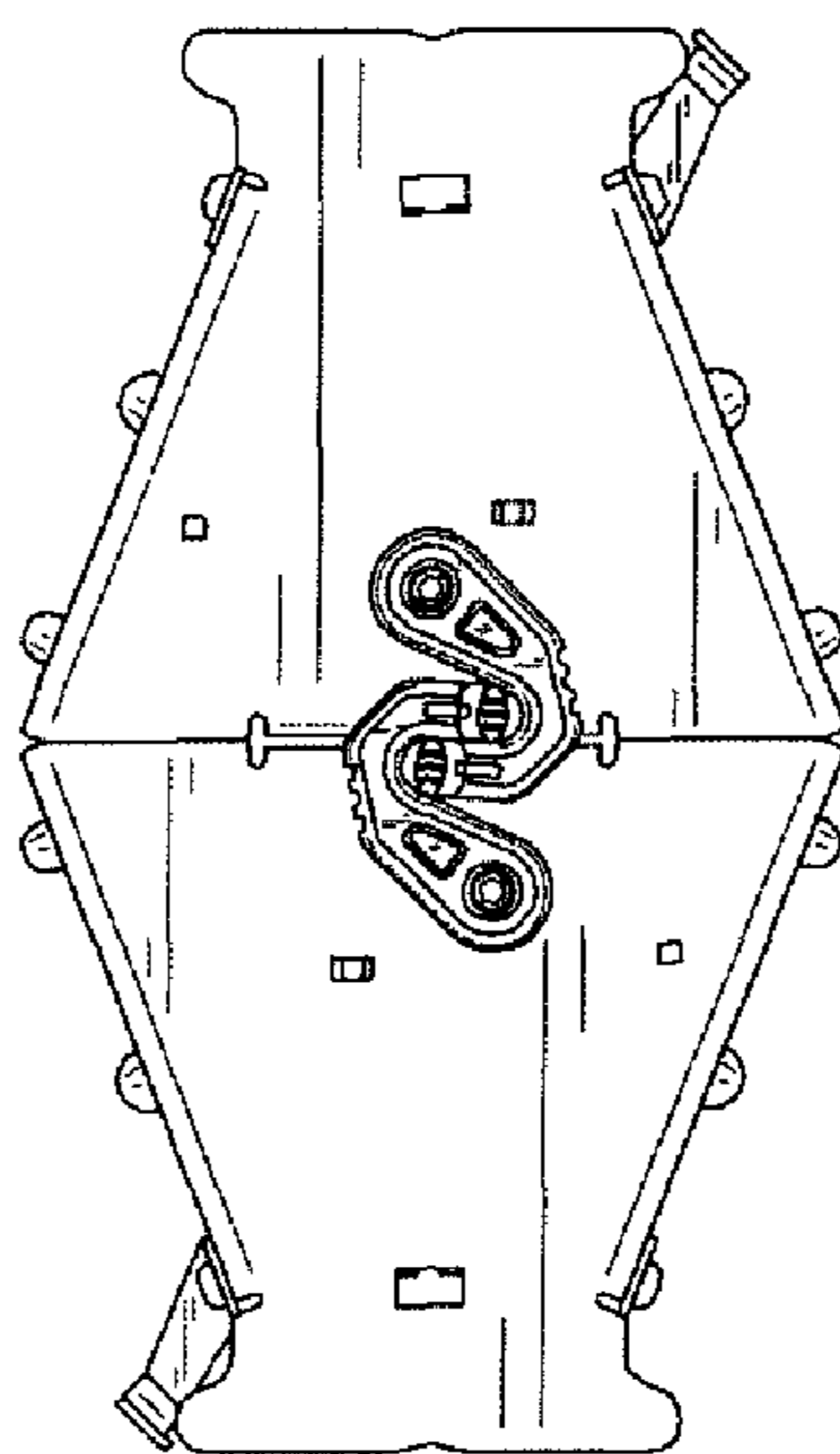

FIG. 5

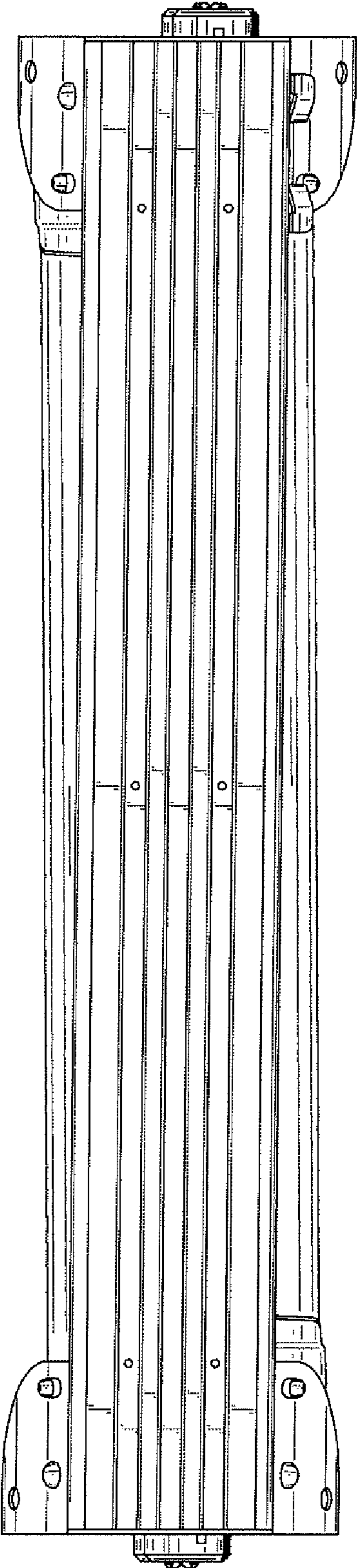

FIG. 6

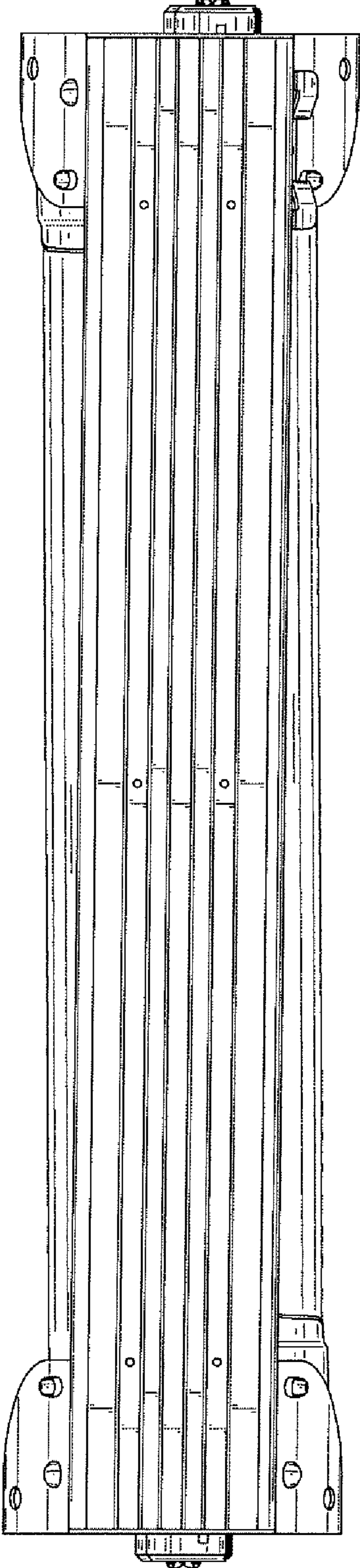

FIG. 7