



US00D638111S

(12) **United States Design Patent**  
**Hafer et al.**

(10) **Patent No.:** **US D638,111 S**  
(45) **Date of Patent:** **\*\* May 17, 2011**

- (54) **VAPORIZER**
- (75) Inventors: **Kevin Hafer**, Phoenix, AZ (US); **Rick Althouse**, Scottsdale, AZ (US); **Nancy Miiller**, Cave Creek, AZ (US); **Phillip Brookshire**, Cincinnati, OH (US); **Gil Schmidt**, Cincinnati, OH (US)
- (73) Assignee: **The Dial Corporation**, Scottsdale, AZ (US)
- (\*\*) Term: **14 Years**
- (21) Appl. No.: **29/291,101**
- (22) Filed: **Aug. 14, 2007**
- (51) **LOC (9) Cl.** ..... **23-04**
- (52) **U.S. Cl.** ..... **D23/360**
- (58) **Field of Classification Search** ..... D23/360, D23/366, 355, 356, 359, 364, 332, 333, 335, D23/342; 422/120, 122; 55/356, 473, 504; 392/390, 392, 395, 403; 261/DIG. 65  
See application file for complete search history.

- D487,144 S \* 2/2004 Choke-arpornchai et al. .... D23/366
  - D501,921 S \* 2/2005 Caserta et al. .... D23/366
  - D510,423 S \* 10/2005 Caserta et al. .... D23/366
  - 6,996,335 B2 \* 2/2006 Zobebe ..... 392/395
  - D535,001 S \* 1/2007 Caserta et al. .... D23/366
  - D535,377 S \* 1/2007 Caserta et al. .... D23/366
  - D538,915 S \* 3/2007 Anderson et al. .... D23/366
  - D551,750 S \* 9/2007 Wefler ..... D23/366
  - 2003/0194355 A1 \* 10/2003 Pedrotti et al. .... 392/403
  - 2005/0213948 A1 \* 9/2005 Caserta et al. .... 392/395
- \* cited by examiner

*Primary Examiner* — David G Muller  
(74) *Attorney, Agent, or Firm* — Paul A. Pappalardo

(57) **CLAIM**  
The ornamental design for a vaporizer, as shown and described.

**DESCRIPTION**

FIG. 1 is a right, front, upper perspective view of a vaporizer embodying our new design;  
FIG. 2 is a front side elevation view thereof;  
FIG. 3 is a rear side elevation view thereof;  
FIG. 4 is a right side elevation view thereof;  
FIG. 5 is a left side elevation view thereof;  
FIG. 6 is a top plan view thereof; and,  
FIG. 7 is a bottom plan view thereof.  
The broken lines are for illustrative purposes only and form no part of the claimed design.

**1 Claim, 4 Drawing Sheets**

- (56) **References Cited**
- U.S. PATENT DOCUMENTS
- D433,113 S \* 10/2000 Cole ..... D23/360
- D449,101 S \* 10/2001 Wolpert et al. .... D23/366
- D478,379 S \* 8/2003 Talenton et al. .... D23/366

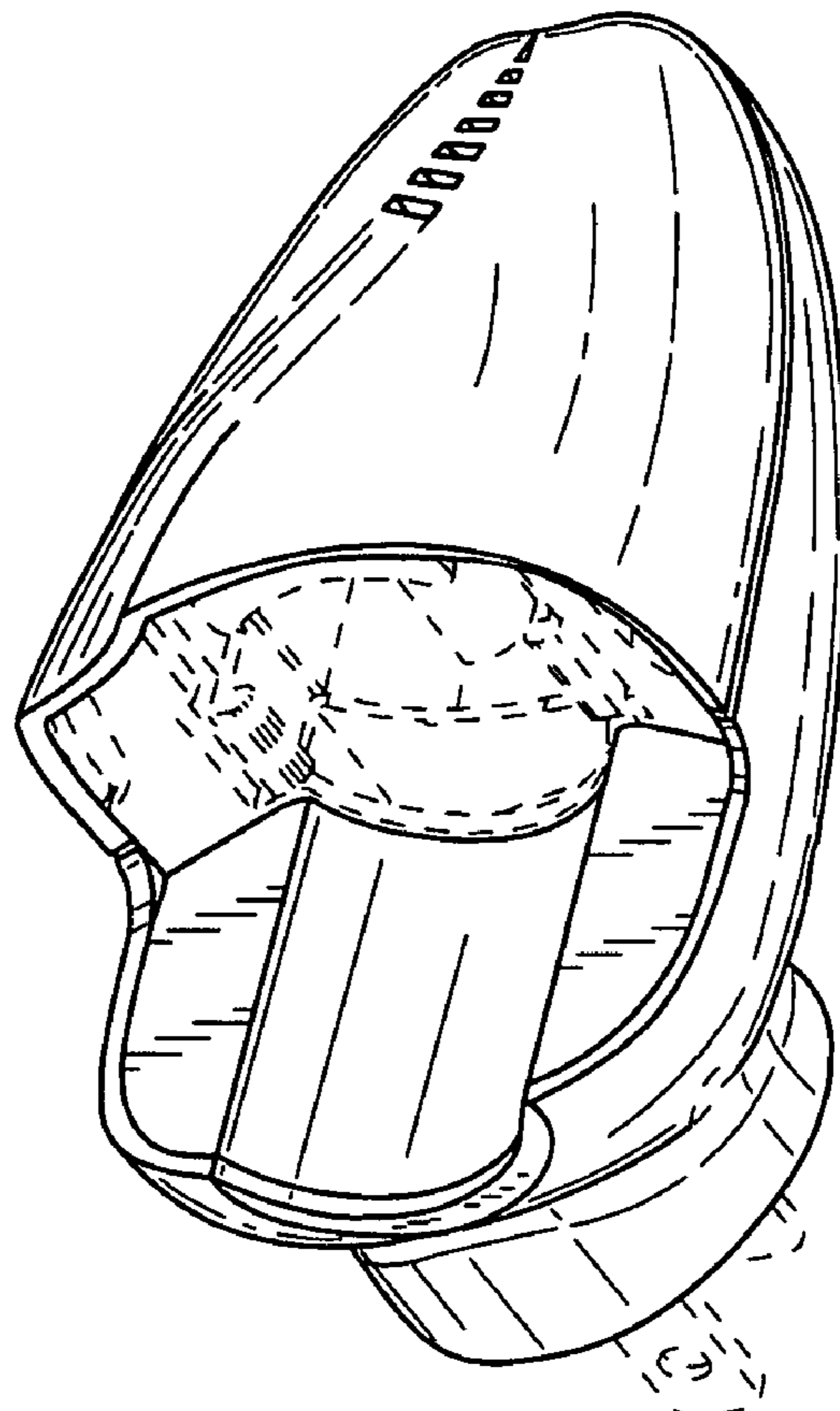

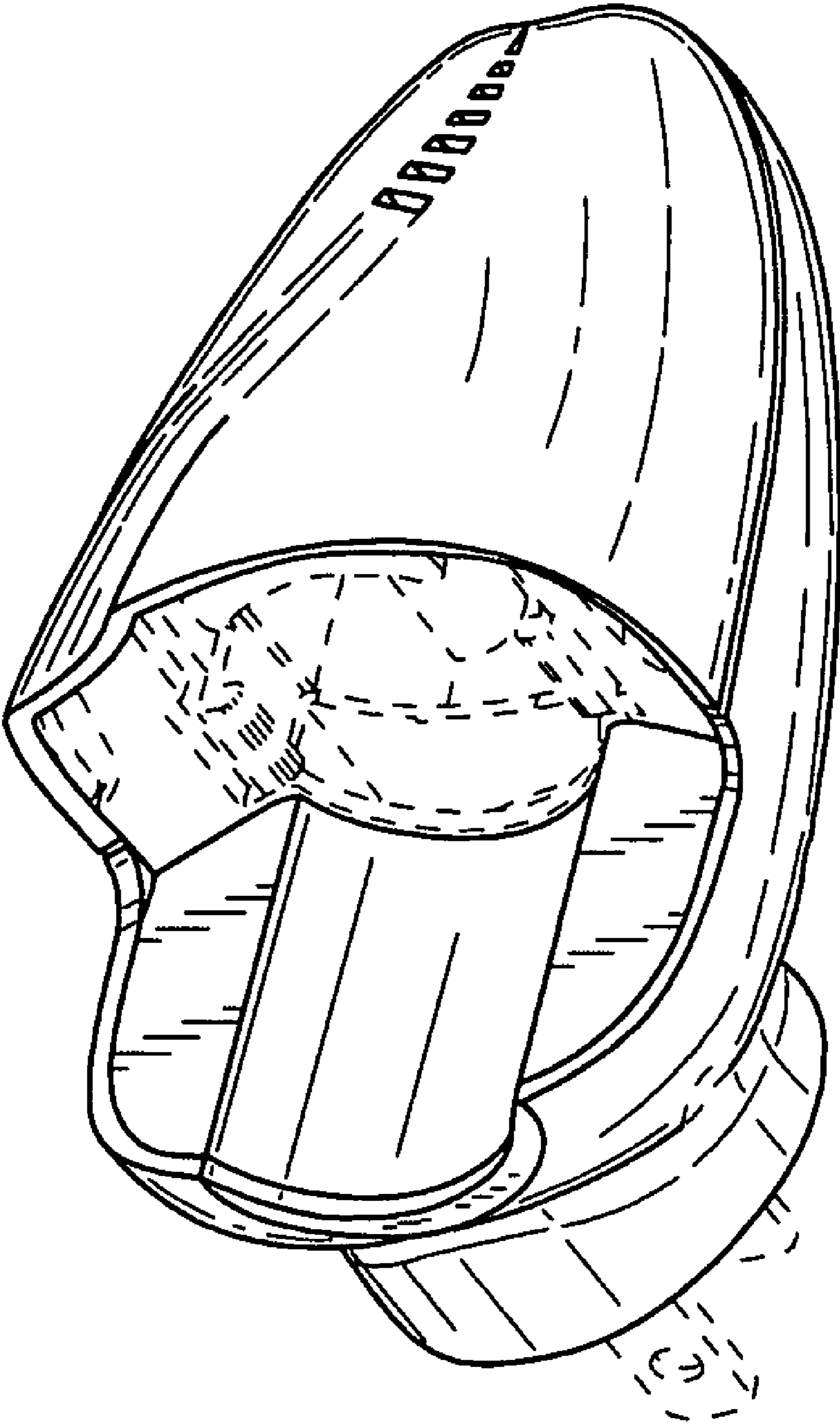

FIG. 1

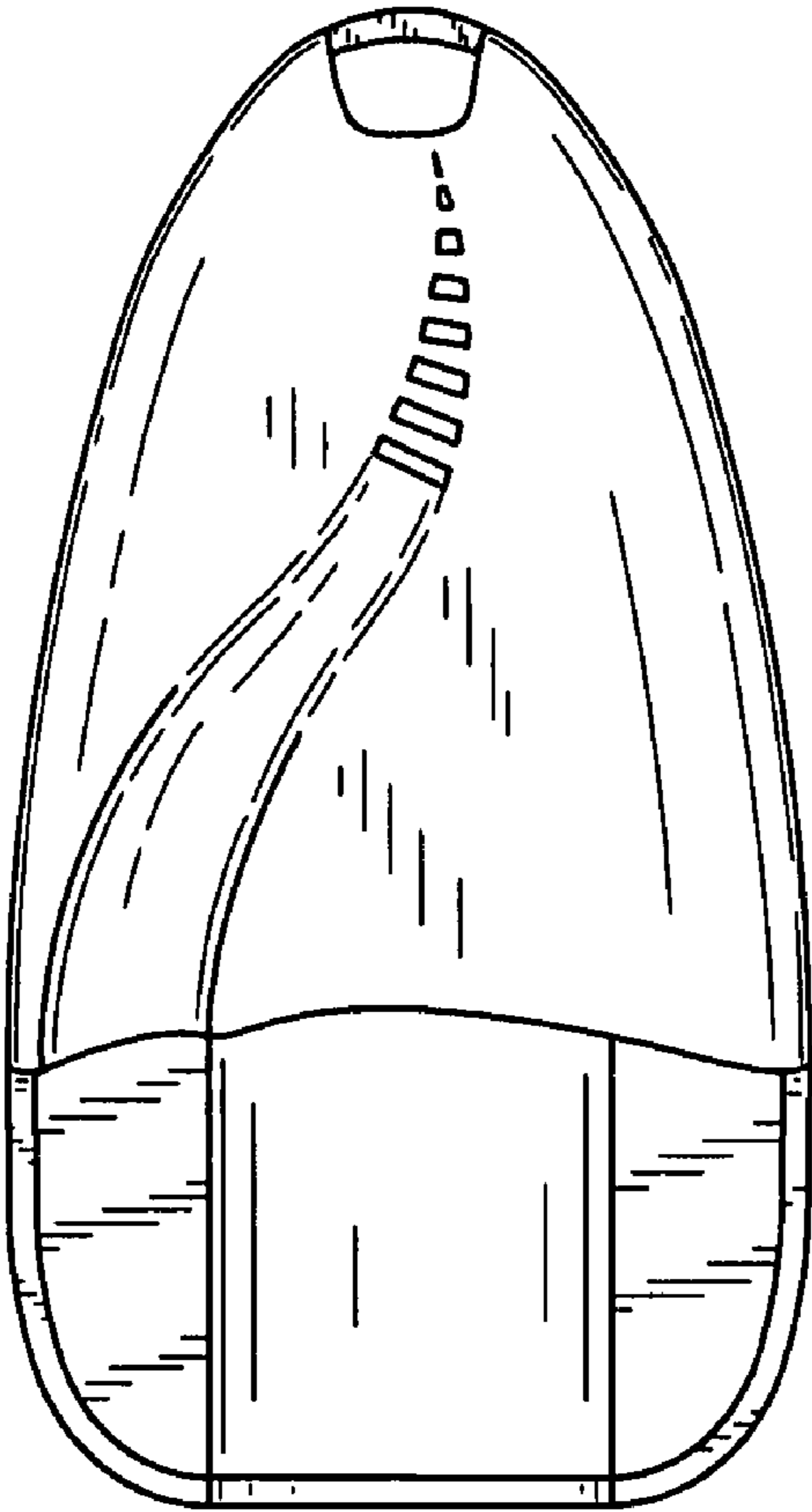

FIG. 2

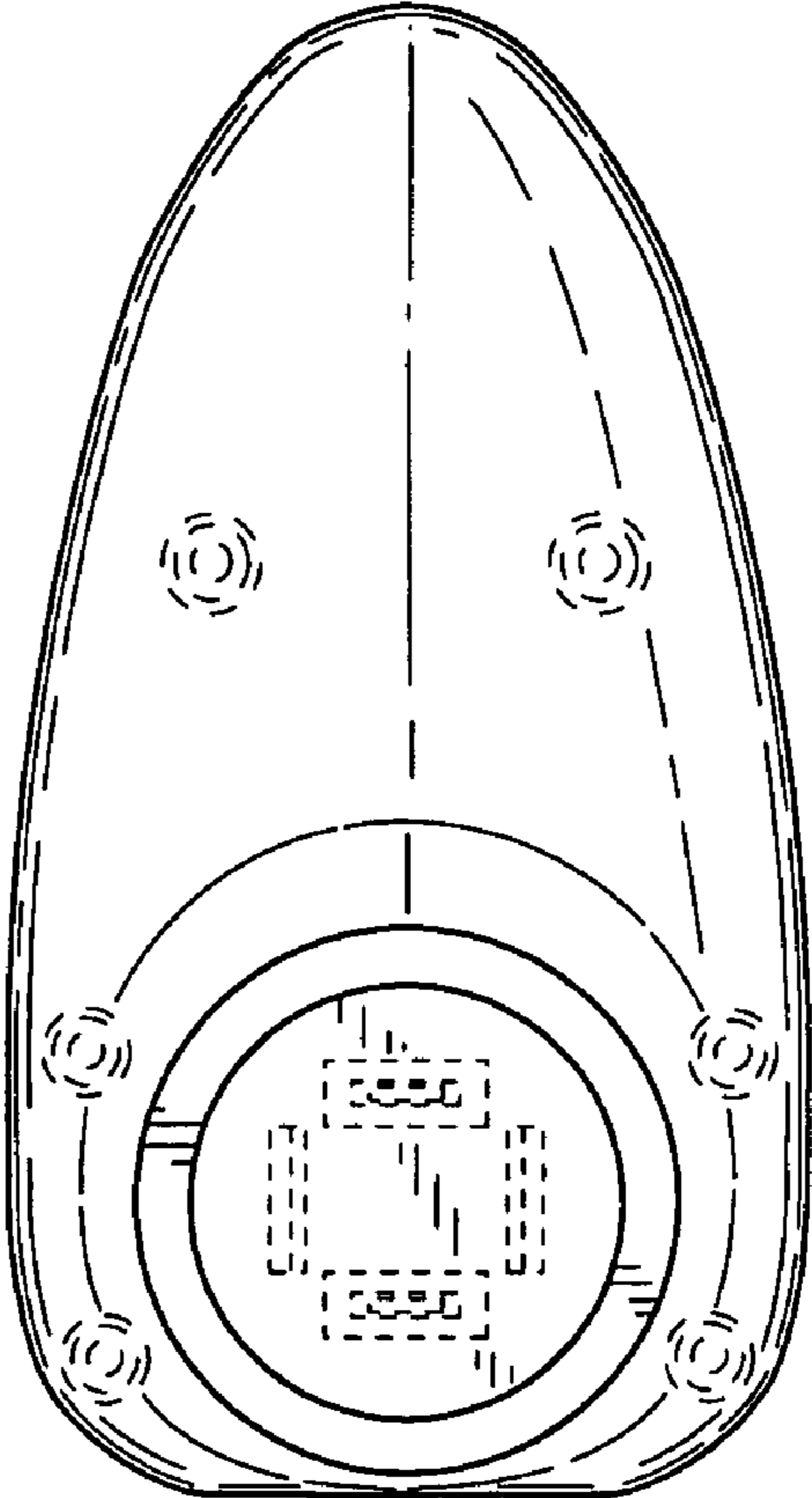

FIG. 3

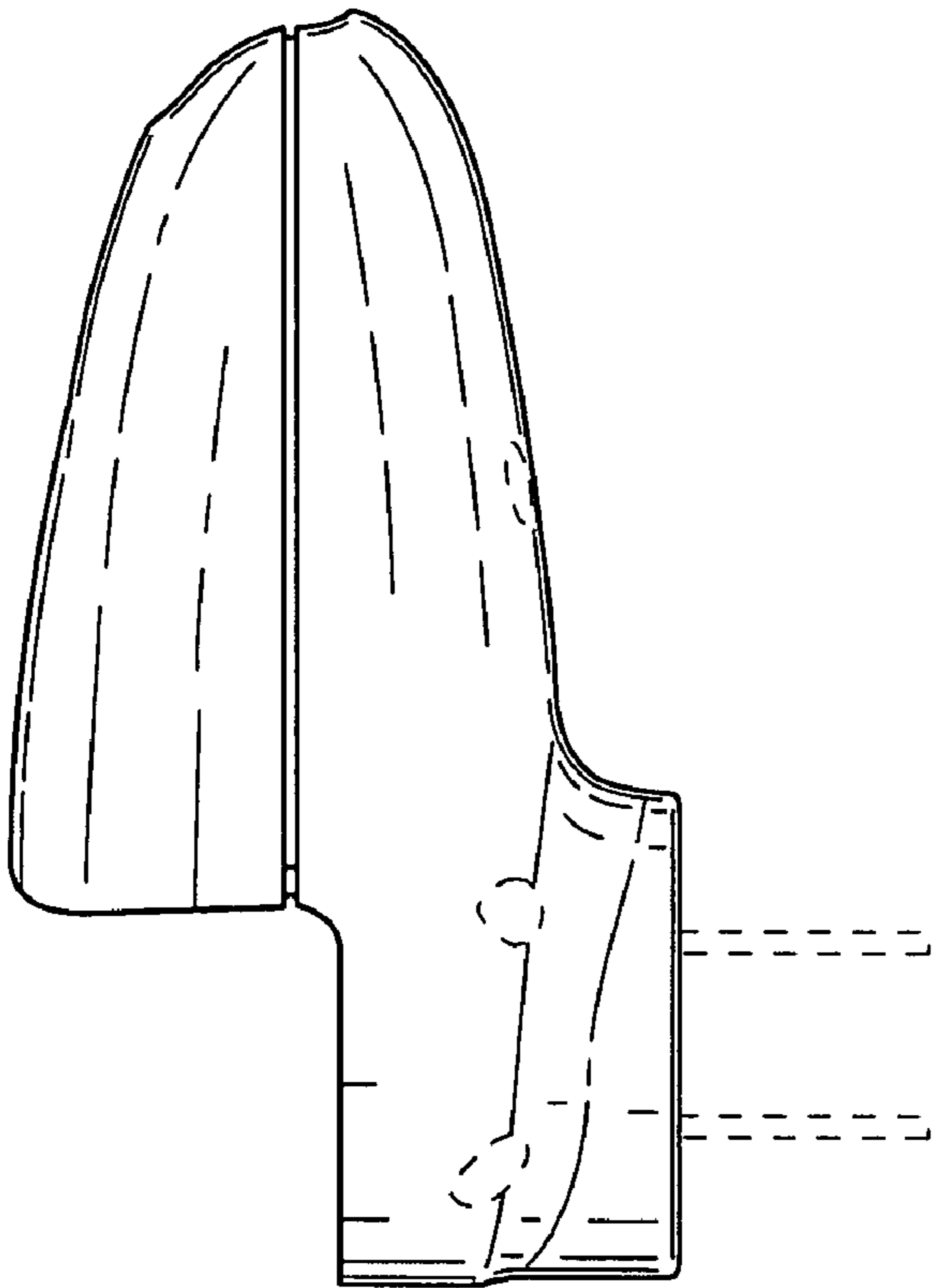

FIG.4

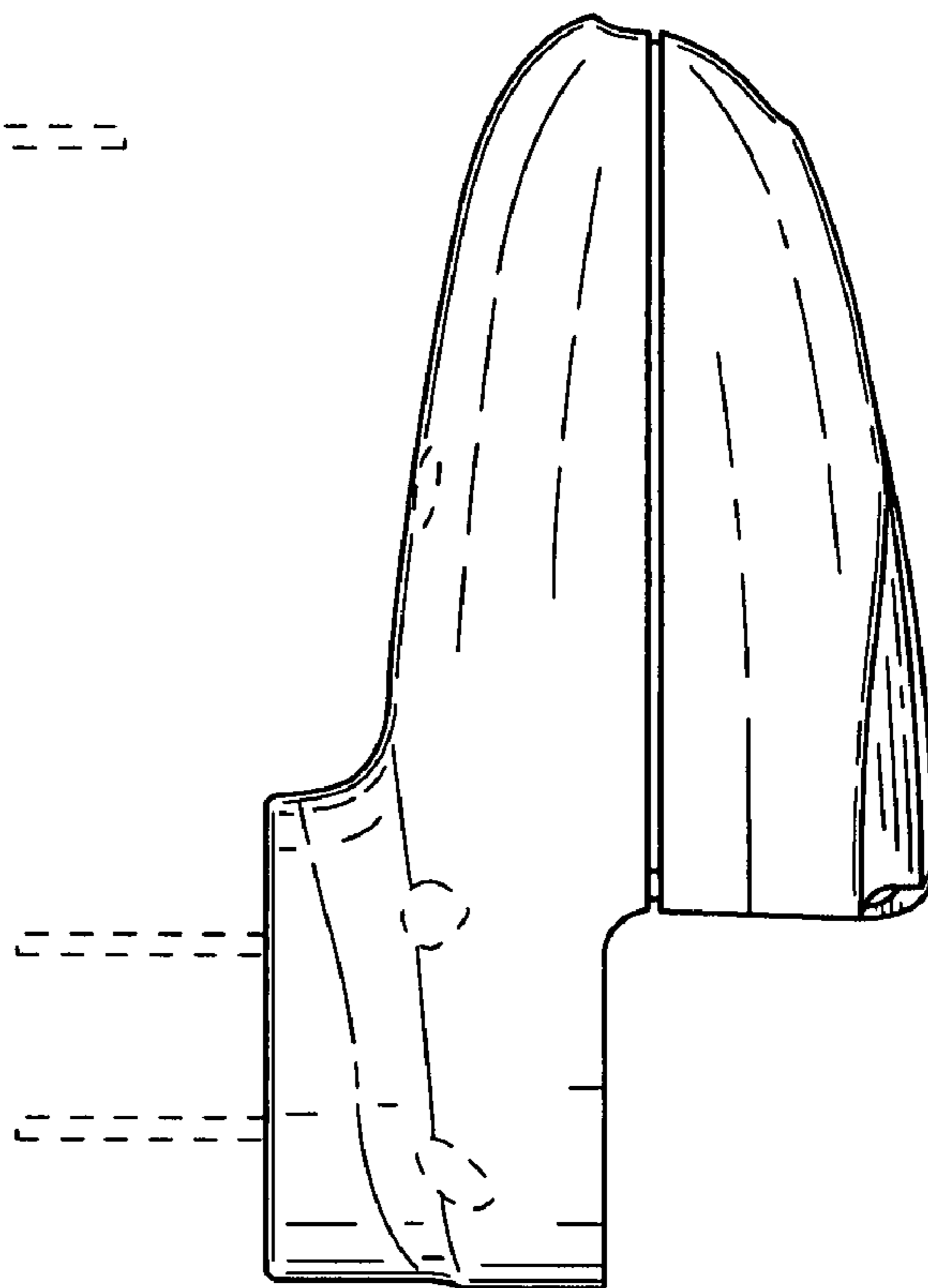

FIG.5

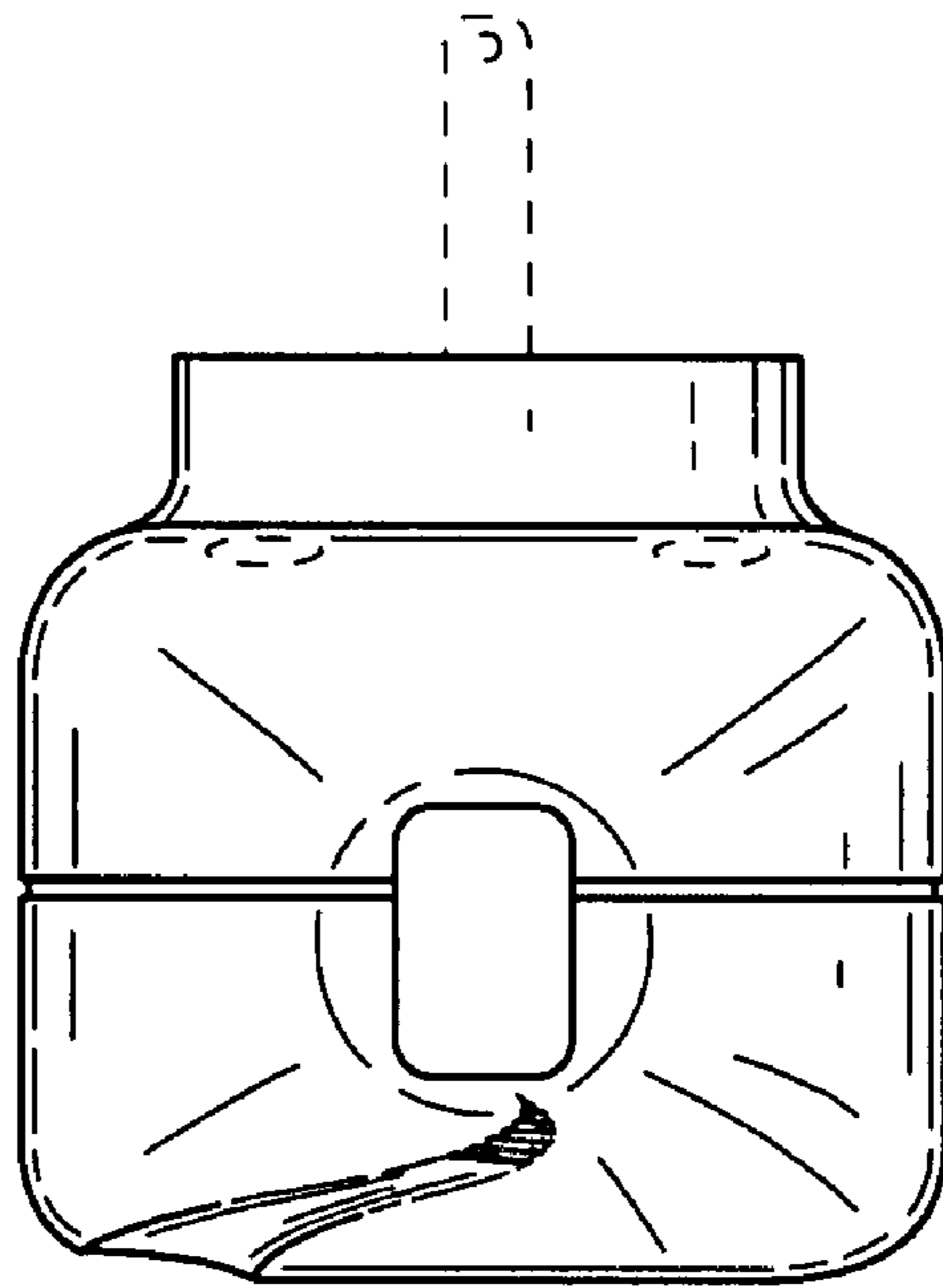

FIG. 6

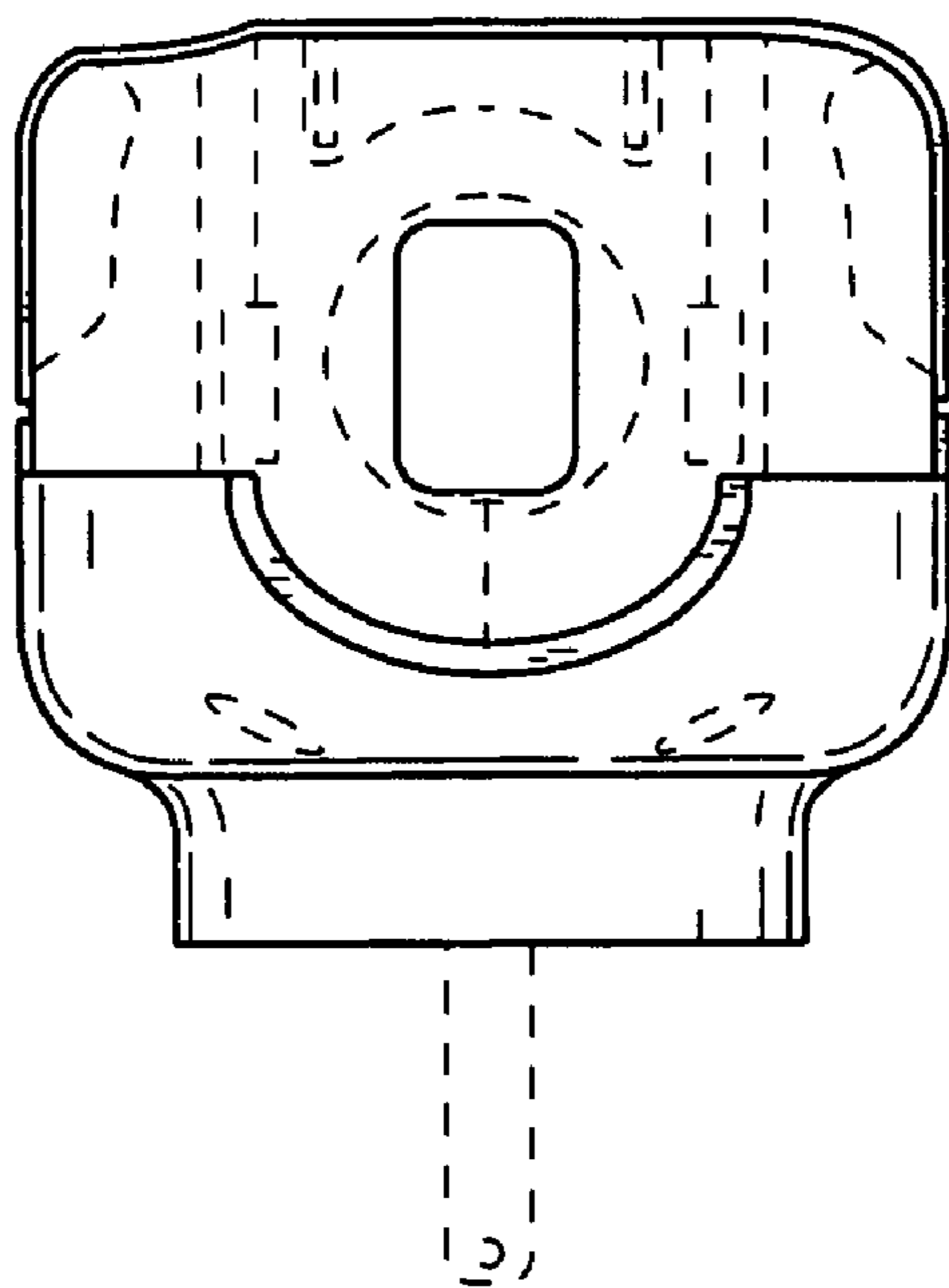

FIG. 7