



US00D638062S

(12) **United States Design Patent**  
**Wang**

(10) **Patent No.:** **US D638,062 S**

(45) **Date of Patent:** **\*\* \*May 17, 2011**

- (54) **PEN**
- (75) Inventor: **Weijie Wang**, Ningbo (CN)
- (73) Assignee: **Beifa Group Co., Ltd.**, Ningbo (CN)
- (\*) Notice: This patent is subject to a terminal disclaimer.
- (\*\*) Term: **14 Years**
- (21) Appl. No.: **29/351,345**
- (22) Filed: **Dec. 3, 2009**

D265,212 S *	6/1982	Spiegel	.....	D19/47
D266,769 S	11/1982	Camps		
D267,887 S	2/1983	Rigoni		
D270,547 S	9/1983	Bajusz		
D282,553 S	2/1986	LeBlanc		
D283,825 S	5/1986	Hechter		
D287,736 S	1/1987	Henkels		
D297,021 S	8/1988	Grossiord		
D303,990 S	10/1989	Petterson		
D305,245 S *	12/1989	Chuang	.....	D19/57
D310,308 S	9/1990	Wolsey		
D329,459 S *	9/1992	Sullivan	.....	D19/36
D344,936 S *	3/1994	Gilpin et al.	.....	D14/431
D359,983 S	7/1995	Rosenbaum		
D362,269 S *	9/1995	Hollington	.....	D19/51

(Continued)

(30) **Foreign Application Priority Data**

Jun. 4, 2009 (CN) ..... 2009 3 0181808

- (51) **LOC (9) Cl.** ..... **19-06**
- (52) **U.S. Cl.** ..... **D19/49**
- (58) **Field of Classification Search** ..... D19/35,  
D19/36, 41, 42, 43, 44, 45, 46, 47, 48, 49,  
D19/50, 51, 53, 54, 55, 56, 57; 24/11 F,  
24/11 P, 11 R; 401/6, 52, 99, 100, 104, 105,  
401/106, 107, 108, 109, 192, 195, 243, 244,  
401/245, 246, 247  
See application file for complete search history.

(56) **References Cited**

**U.S. PATENT DOCUMENTS**

828,973 A *	8/1906	Sanford	.....	401/158
1,038,068 A *	9/1912	Barrett	.....	401/158
1,477,231 A *	12/1923	Abrams	.....	401/52
D92,705 S *	7/1934	Deli	.....	D19/36
D126,555 S *	4/1941	Gurtov	.....	D8/62
2,251,640 A *	8/1941	Skrainka	.....	33/372
D230,403 S *	2/1974	Englund	.....	D14/431
D252,998 S	9/1979	Turner		
D256,593 S	8/1980	Massoni		
D258,596 S	3/1981	Massoni		

**OTHER PUBLICATIONS**

Wang, W., "Pen," U.S. Appl. No. 29/330,718, filed Jan. 13, 2009.

(Continued)

*Primary Examiner* — Elizabeth A Albert  
*Assistant Examiner* — Karen E Eldridge Powers  
 (74) *Attorney, Agent, or Firm* — Christensen O'Connor Johnson Kindness PLLC

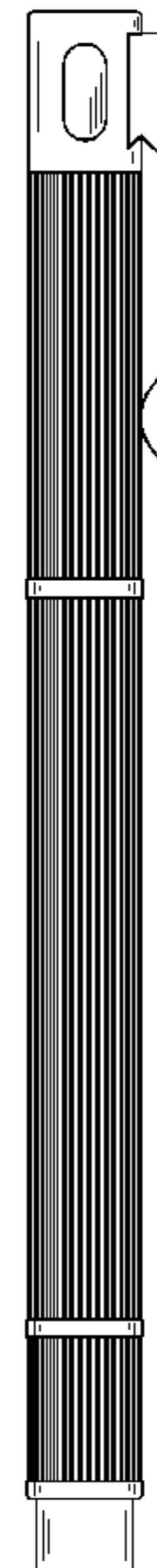
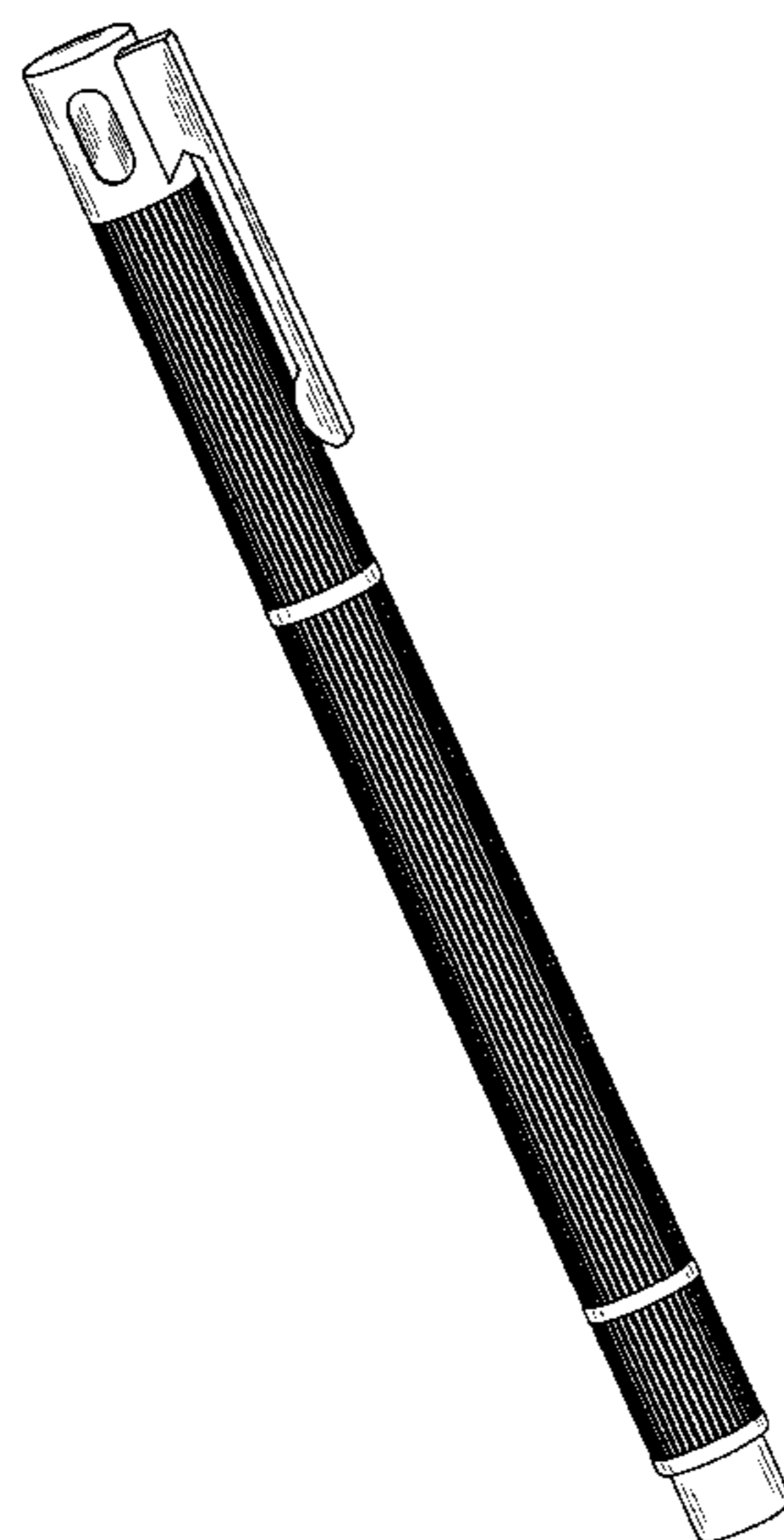
(57) **CLAIM**

The ornamental design for a pen, as shown and described.

**DESCRIPTION**

FIG. 1 is an upper left perspective view of a pen showing my new design;  
 FIG. 2 is a left side elevation view thereof;  
 FIG. 3 is an enlarged bottom plan view thereof;  
 FIG. 4 is a rear elevation view thereof;  
 FIG. 5 is a right side elevation view thereof;  
 FIG. 6 is an enlarged top plan view thereof; and,  
 FIG. 7 is a front elevation view thereof.

**1 Claim, 3 Drawing Sheets**



# US D638,062 S

Page 2

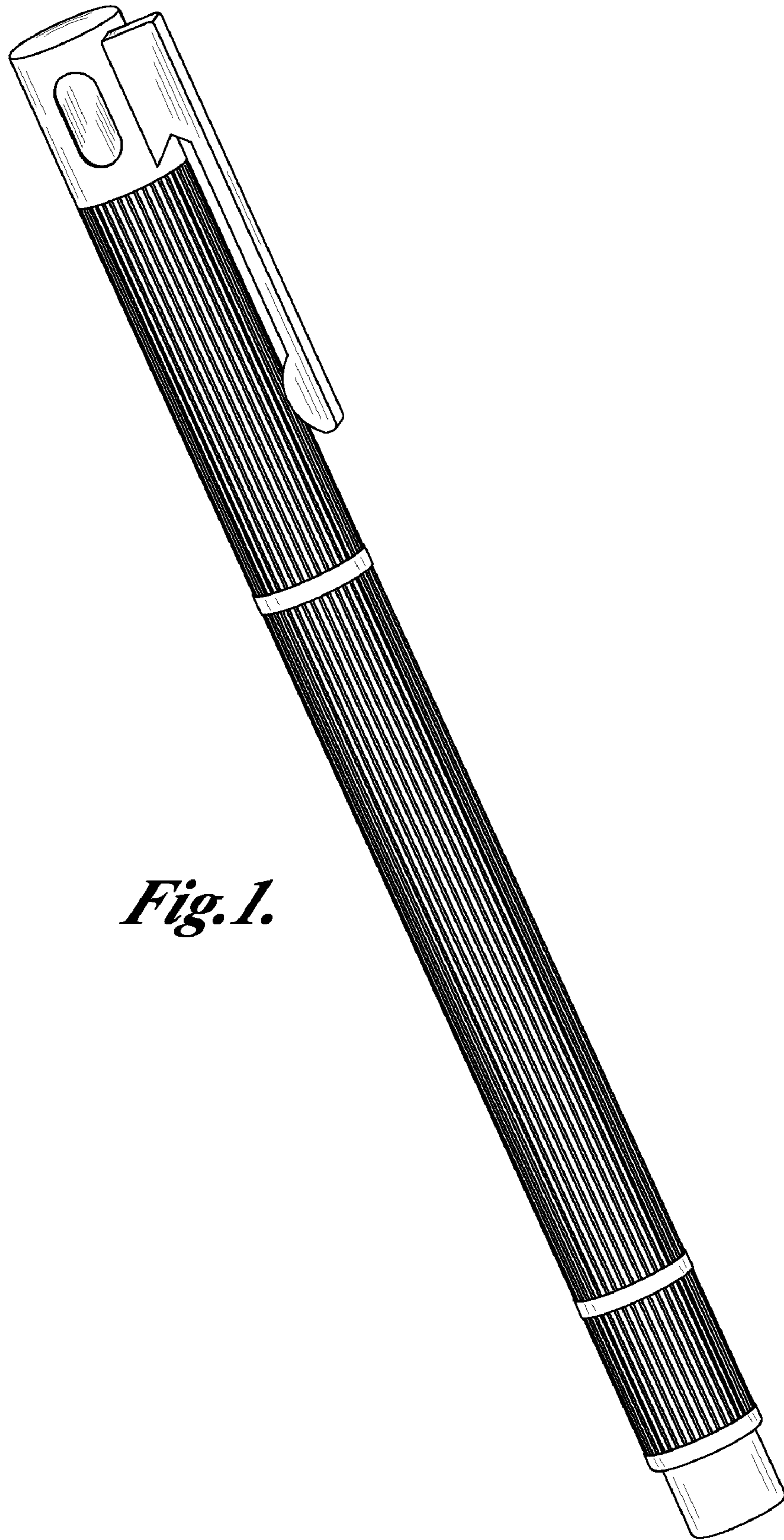
## U.S. PATENT DOCUMENTS

D363,084 S *	10/1995	Hollington	.....	D19/51	D584,771 S *	1/2009	Gerules et al.	.....	D19/41
D363,309 S	10/1995	Carpani			D590,876 S *	4/2009	Shi	.....	D19/36
D370,497 S	6/1996	Moore			D595,772 S	7/2009	Zhang		
D386,525 S	11/1997	Voegeli			D598,954 S	8/2009	Wang		
D391,294 S *	2/1998	Izushima	.....	D19/57	D601,627 S	10/2009	Liu		
D402,695 S *	12/1998	Izushima	.....	D19/51	D602,086 S *	10/2009	Liu	.....	D19/49
D417,700 S	12/1999	Wörther			D603,900 S *	11/2009	Jin	.....	D19/54
D437,888 S	2/2001	Keil			D606,587 S	12/2009	Zhang		
D458,965 S	6/2002	Oka			D607,934 S	1/2010	Liu		
D467,970 S	12/2002	Pellissa Beneyto			D610,616 S	2/2010	Li		
6,599,045 B1 *	7/2003	Kolb	.....	401/52	D611,095 S	3/2010	Liu		
D478,350 S	8/2003	Furlong			D611,096 S	3/2010	Liu		
D493,524 S *	7/2004	Hawley et al.	.....	D24/114	D611,097 S	3/2010	Liu		
D498,494 S *	11/2004	Conklin et al.	.....	D19/51	D613,335 S *	4/2010	Gerules et al.	.....	D19/41
D502,736 S	3/2005	Chen			D616,498 S *	5/2010	Zhang	.....	D19/49
D545,366 S	6/2007	Ternovits			D616,936 S *	6/2010	Liu	.....	D19/49
D547,375 S	7/2007	Gerules							
D551,296 S	9/2007	Greenberg							
D583,866 S *	12/2008	Eddington et al.	.....	D19/49					

## OTHER PUBLICATIONS

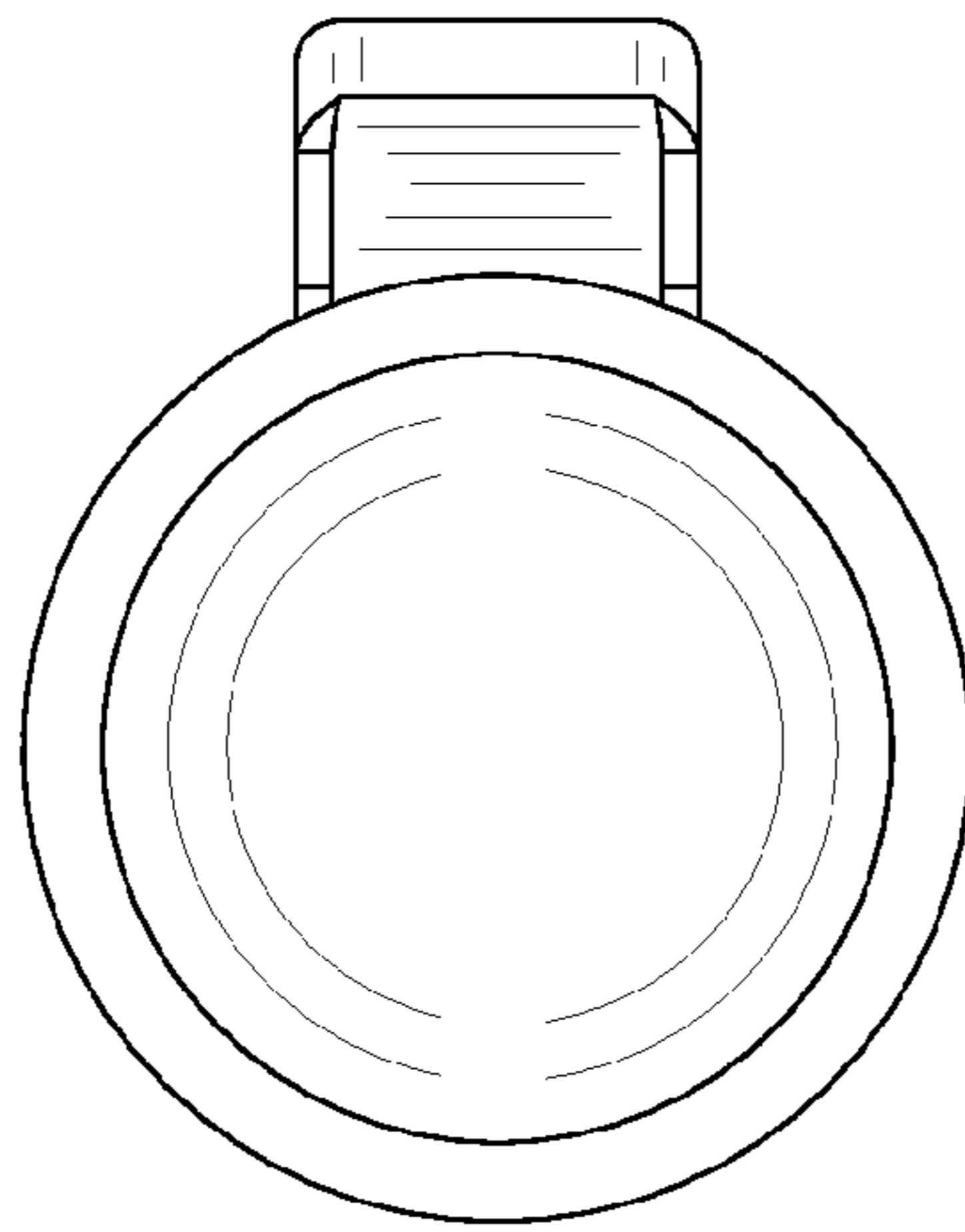
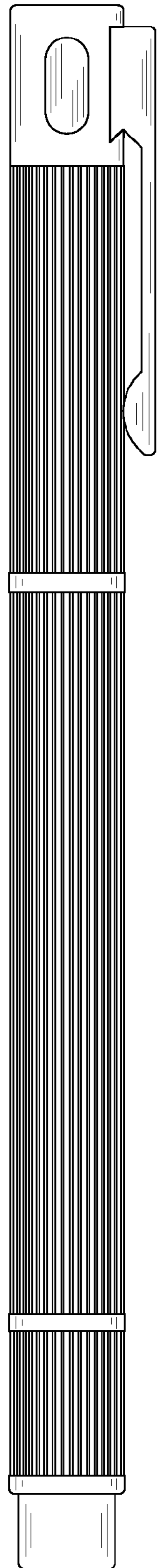
Wang, W., "Pen," U.S. Appl. No. 29/351,344, filed Dec. 3, 2009.

\* cited by examiner



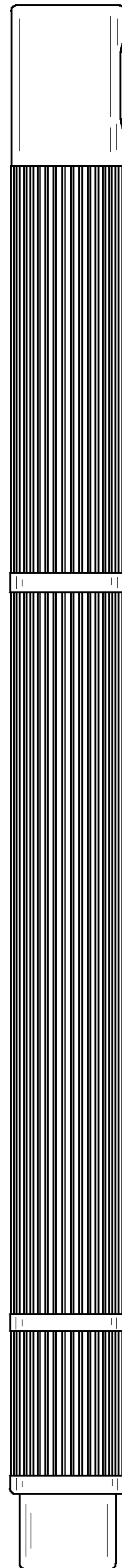
*Fig. 1.*

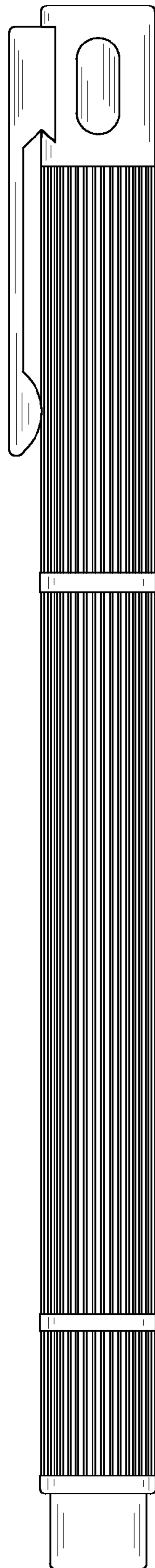
*Fig. 2.*



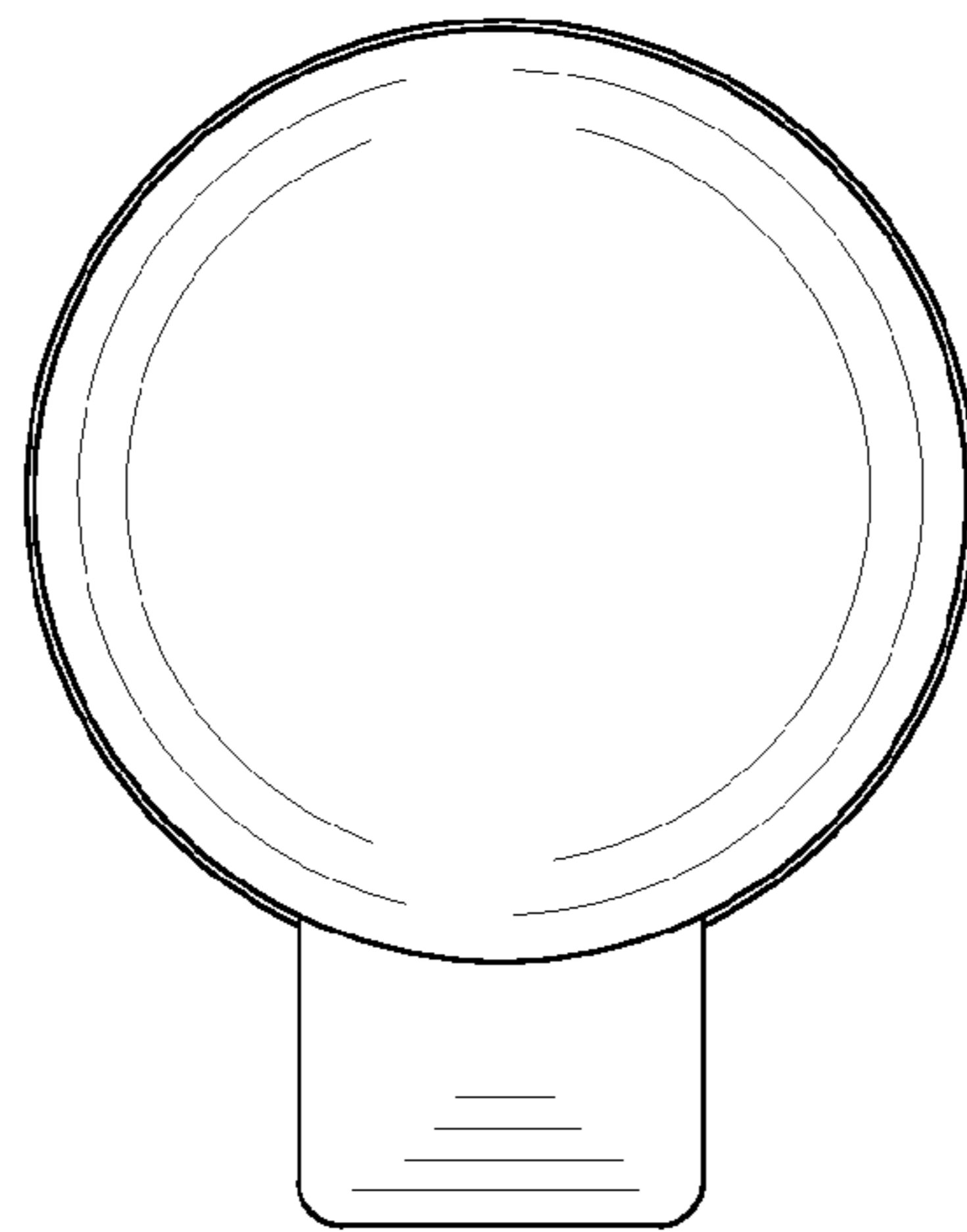
*Fig. 3.*

*Fig. 4.*

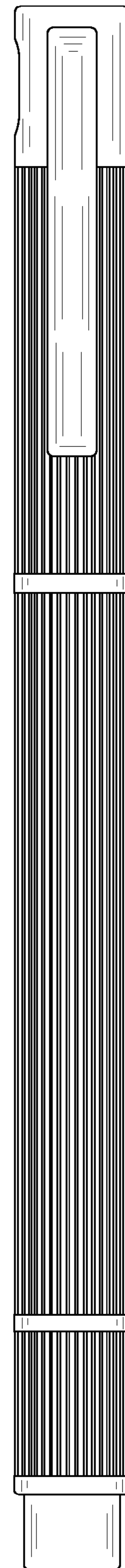




*Fig. 5.*



*Fig. 6.*



*Fig. 7.*