



US00D638029S

(12) **United States Design Patent**
Uesugi et al.

(10) **Patent No.:** **US D638,029 S**

(45) **Date of Patent:** **** May 17, 2011**

(54) **AUDIO PLAYER WITH GUITAR EFFECTS**

(56)

References Cited

(75) Inventors: **Tetsuya Uesugi**, Shizuoka-ken (JP);
Katsutoshi Takatoui, Shizuoka-ken (JP);
Akio Shindate, London (GB); **Matthew Gardiner**, London (GB)

U.S. PATENT DOCUMENTS

D411,997	S	*	7/1999	Ito et al.	D14/217
D442,573	S	*	5/2001	Ito et al.	D14/502
D484,484	S	*	12/2003	Green	D14/204
D513,612	S	*	1/2006	Harris et al.	D14/168
D516,057	S	*	2/2006	Sube	D14/506
D571,356	S	*	6/2008	Smith	D14/214

(73) Assignee: **Roland Corporation**, Shizuoka-ken (JP)

* cited by examiner

(**) Term: **14 Years**

Primary Examiner — Nanda Bondade

(74) *Attorney, Agent, or Firm* — David W. Victor; Konrad Raynes & Victor LLP

(21) Appl. No.: **29/355,337**

(57) **CLAIM**

We claim the ornamental design for an audio player with guitar effects, as shown and described.

(22) Filed: **Feb. 5, 2010**

DESCRIPTION

(30) **Foreign Application Priority Data**

Aug. 25, 2009 (JP) 2009-019392

(51) **LOC (9) Cl.** **14-01**

(52) **U.S. Cl.** **D14/496; D14/168**

(58) **Field of Classification Search** D14/496,
D14/498-511, 167-168, 188, 197-198, 209.1,
D14/210-214, 217; 360/99.02, 99.07; 369/75.11,
369/75.21, 77.11, 77.21; 720/601, 612, 619,
720/649, 655; 455/344, 347-351

FIG. 1 is a front perspective view of an audio player with guitar effects showing our new design; FIG. 2 is a front view thereof; FIG. 3 is a rear view thereof; FIG. 4 is a plan view thereof; FIG. 5 is a bottom view thereof; FIG. 6 is a left side view thereof; and, FIG. 7 is a right side view thereof.

The ornamental design which is claimed is shown in solid lines in the drawings. The broken lines in the drawings are for illustrative purposes only and form no part of the claimed design.

See application file for complete search history.

1 Claim, 4 Drawing Sheets

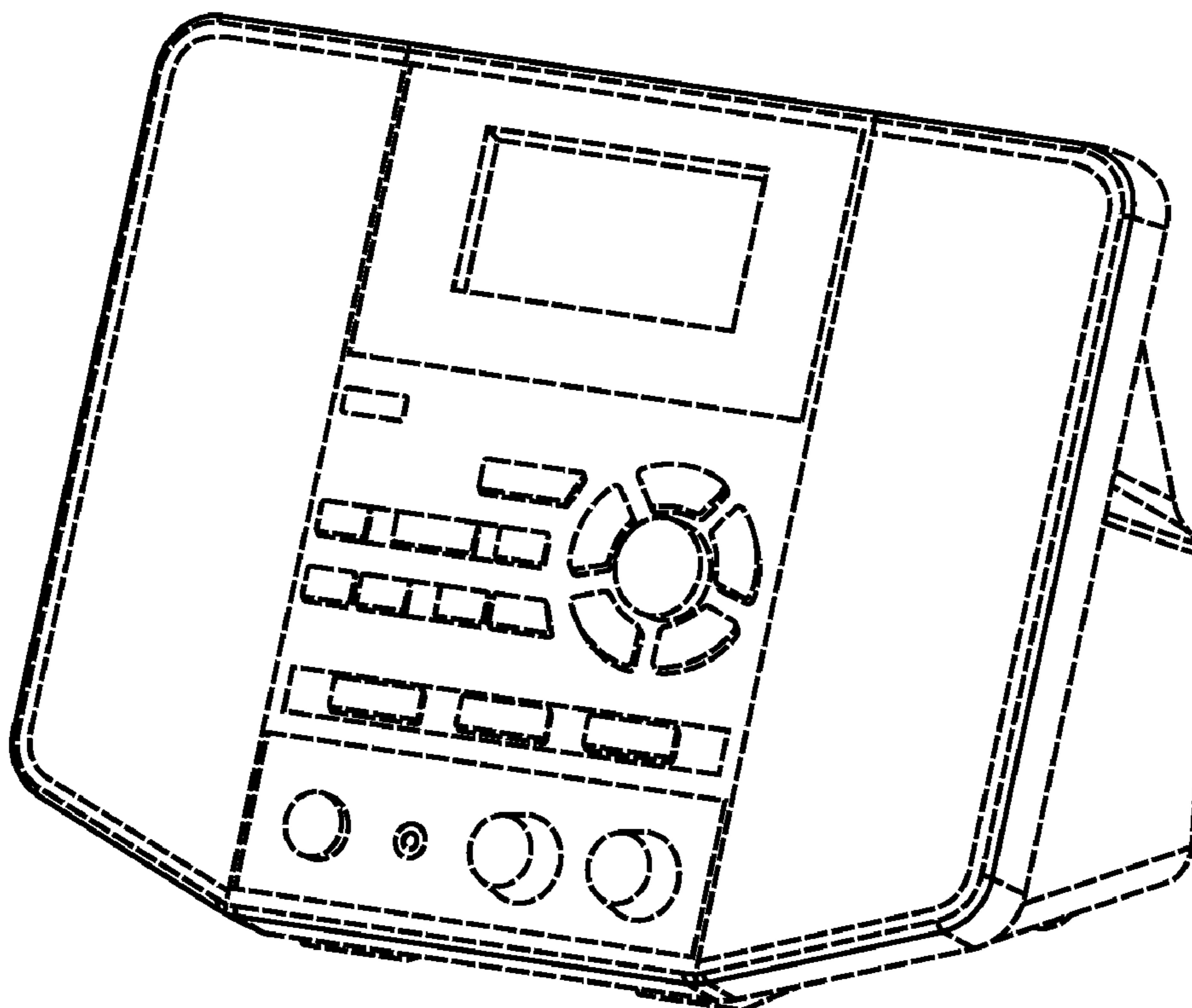

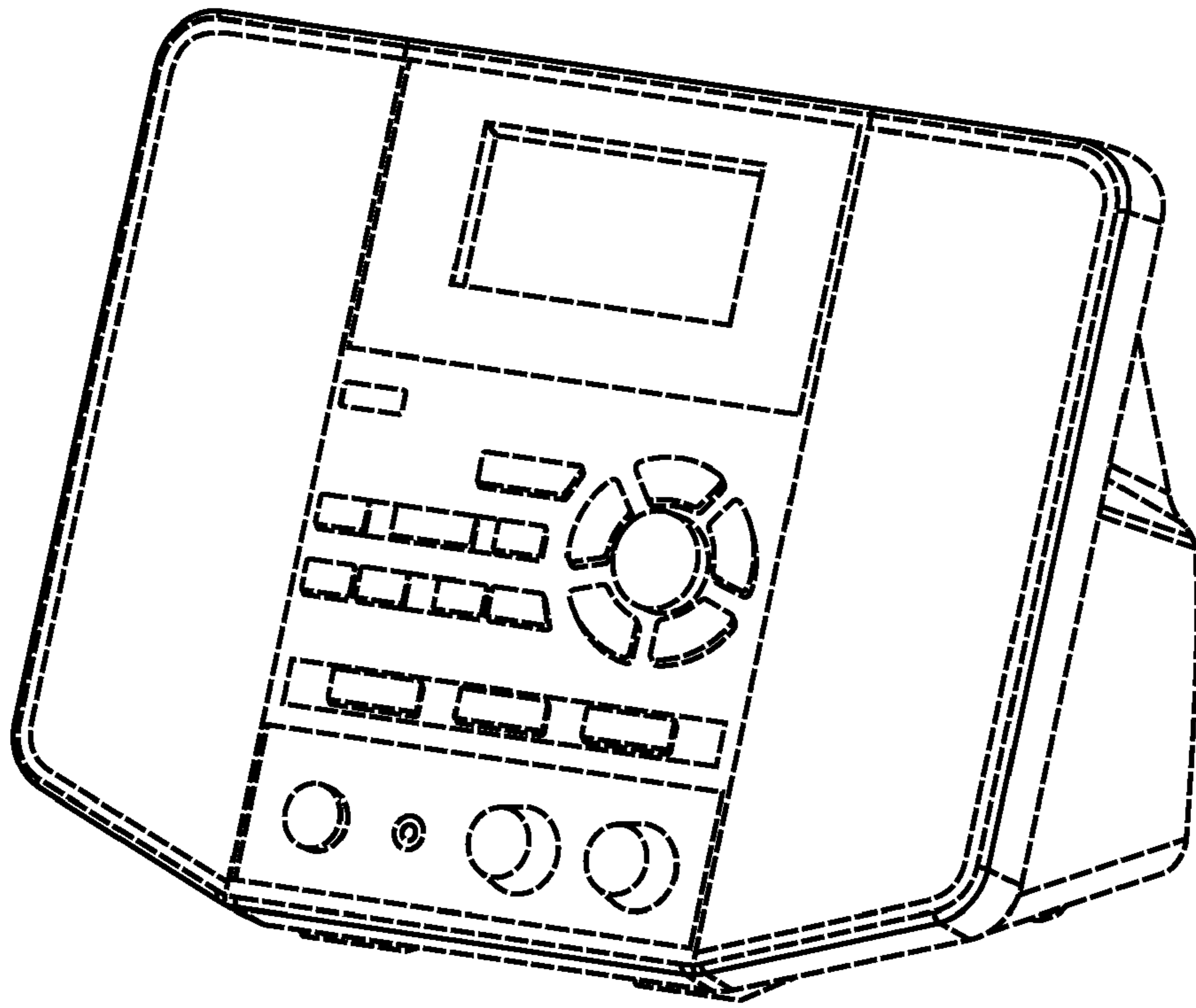

FIG. 1

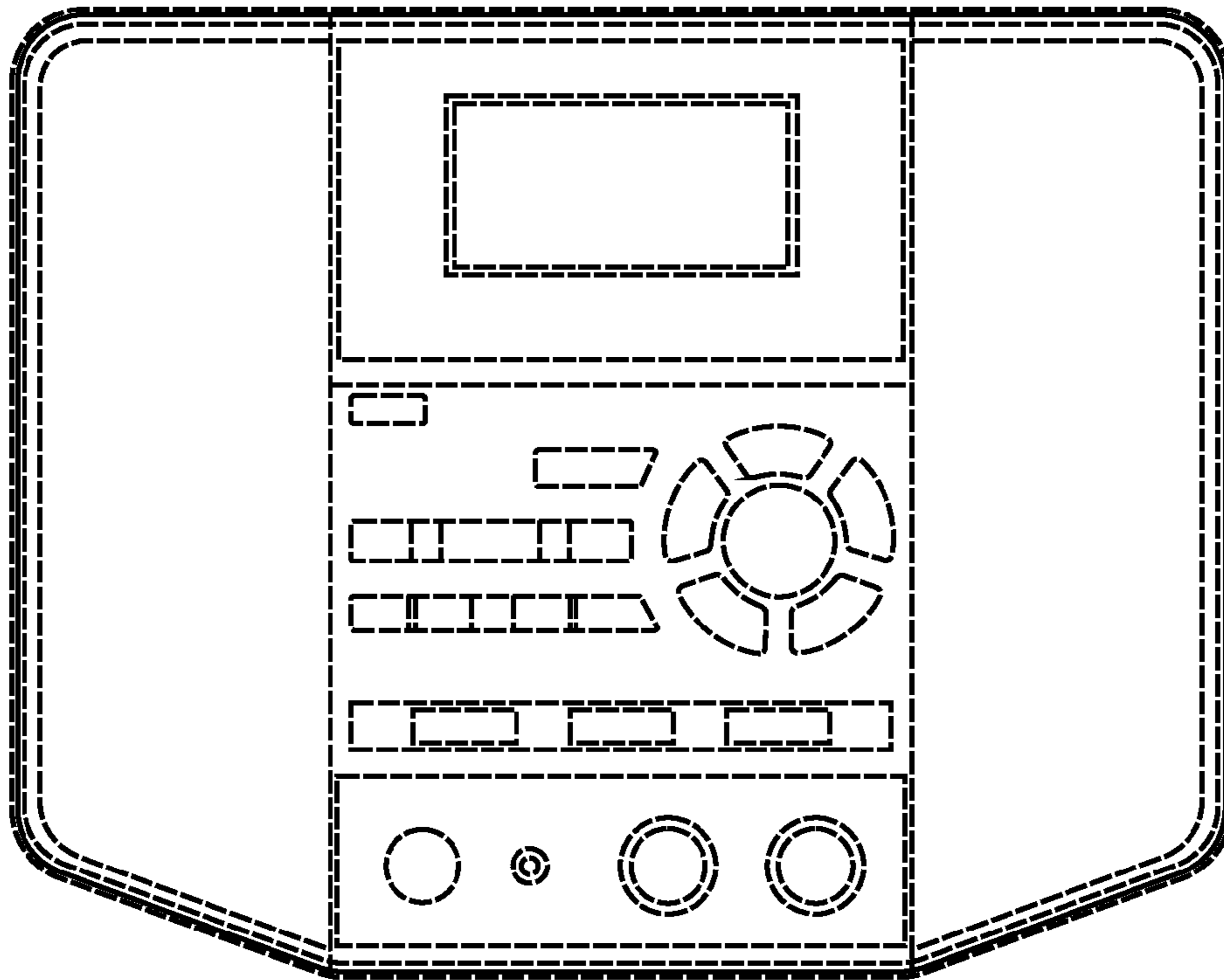

FIG. 2

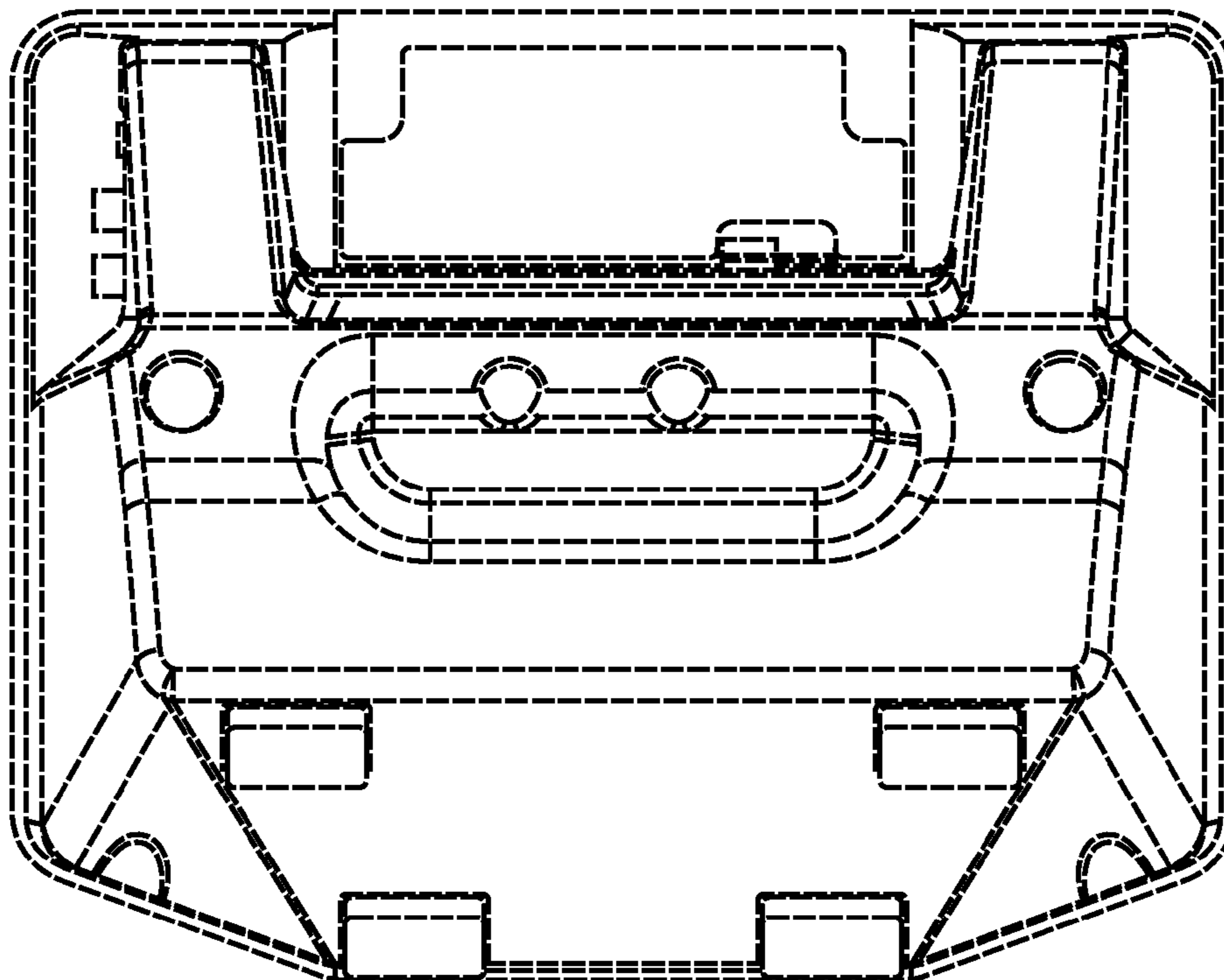

FIG. 3

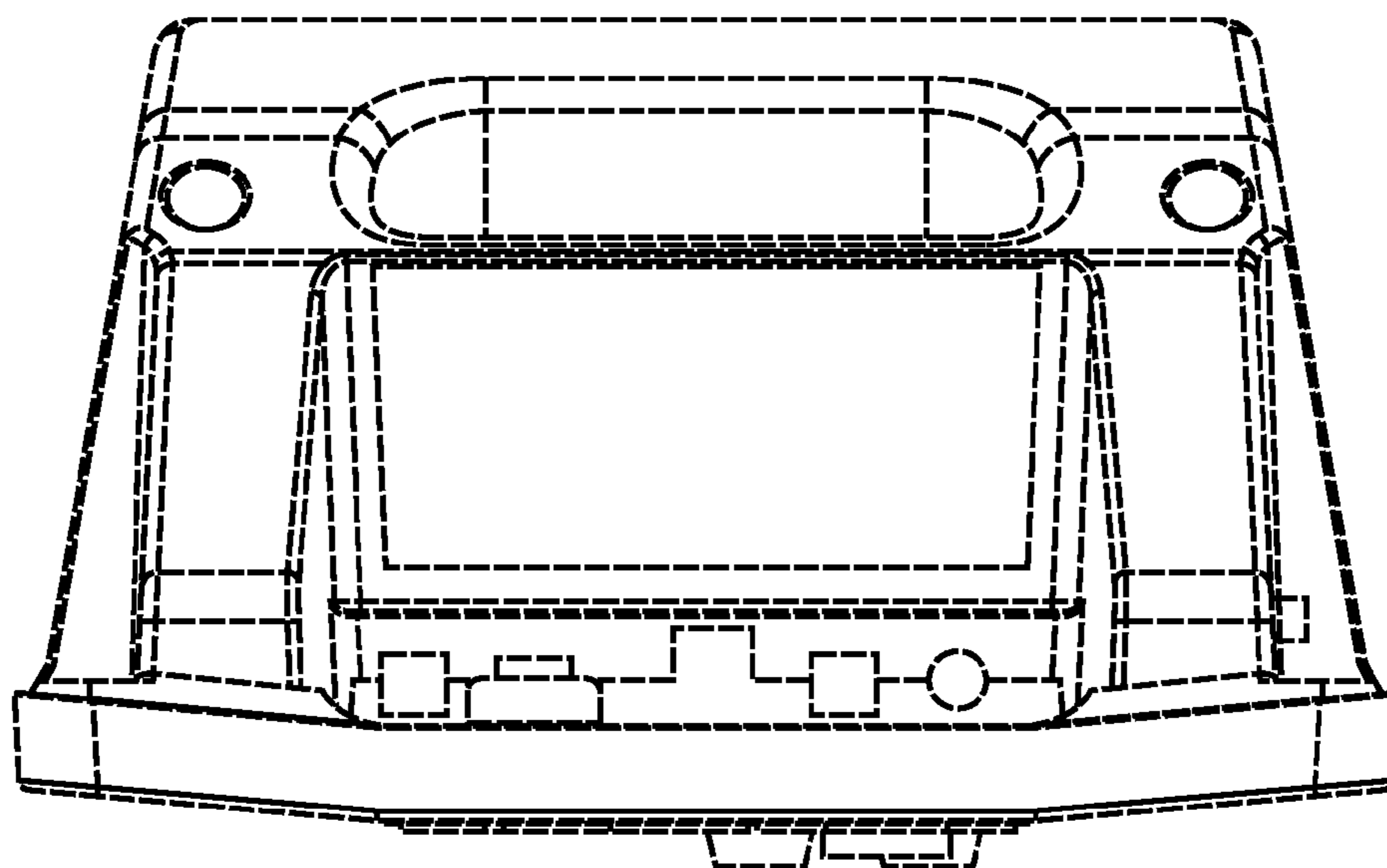

FIG. 4

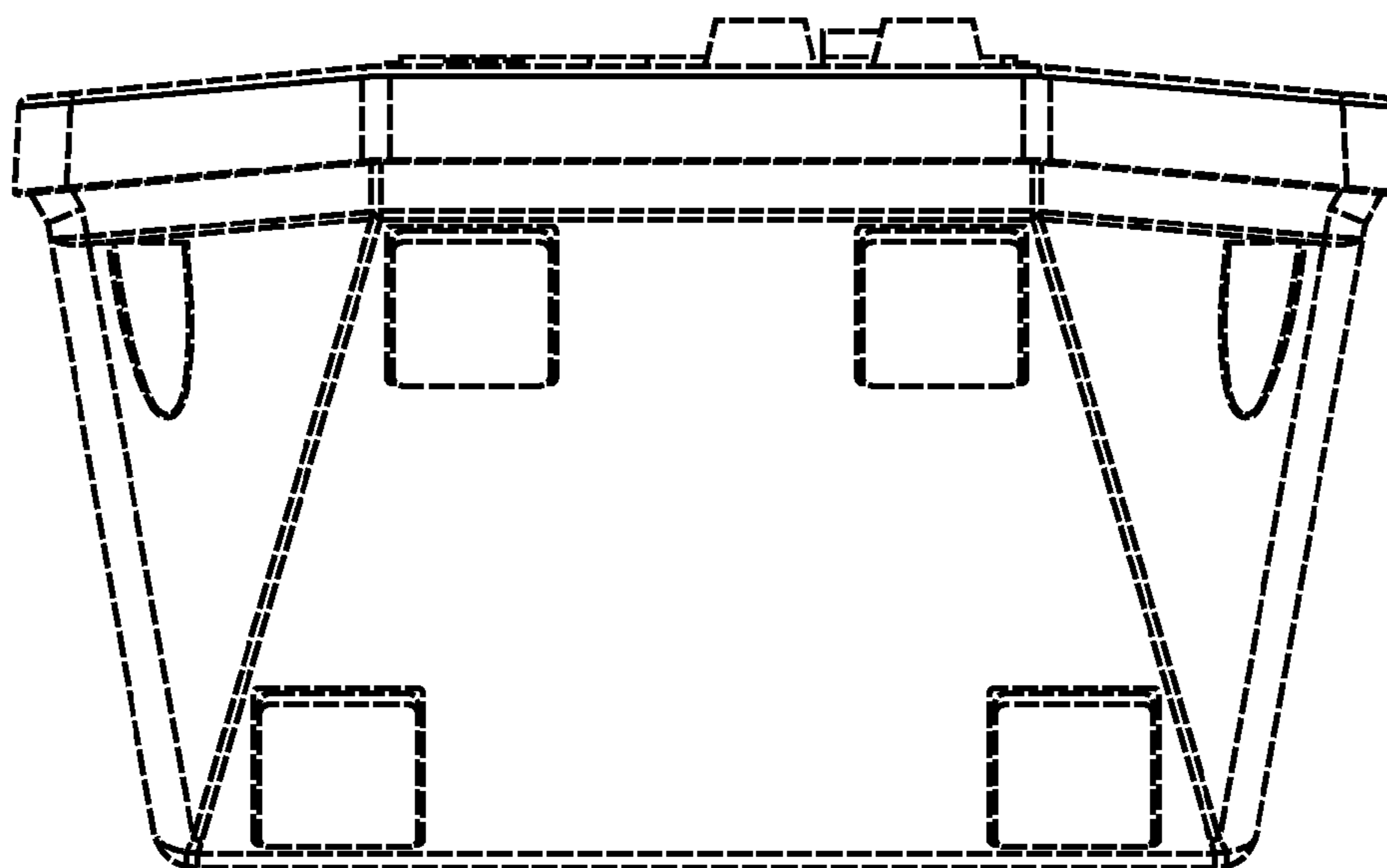

FIG. 5

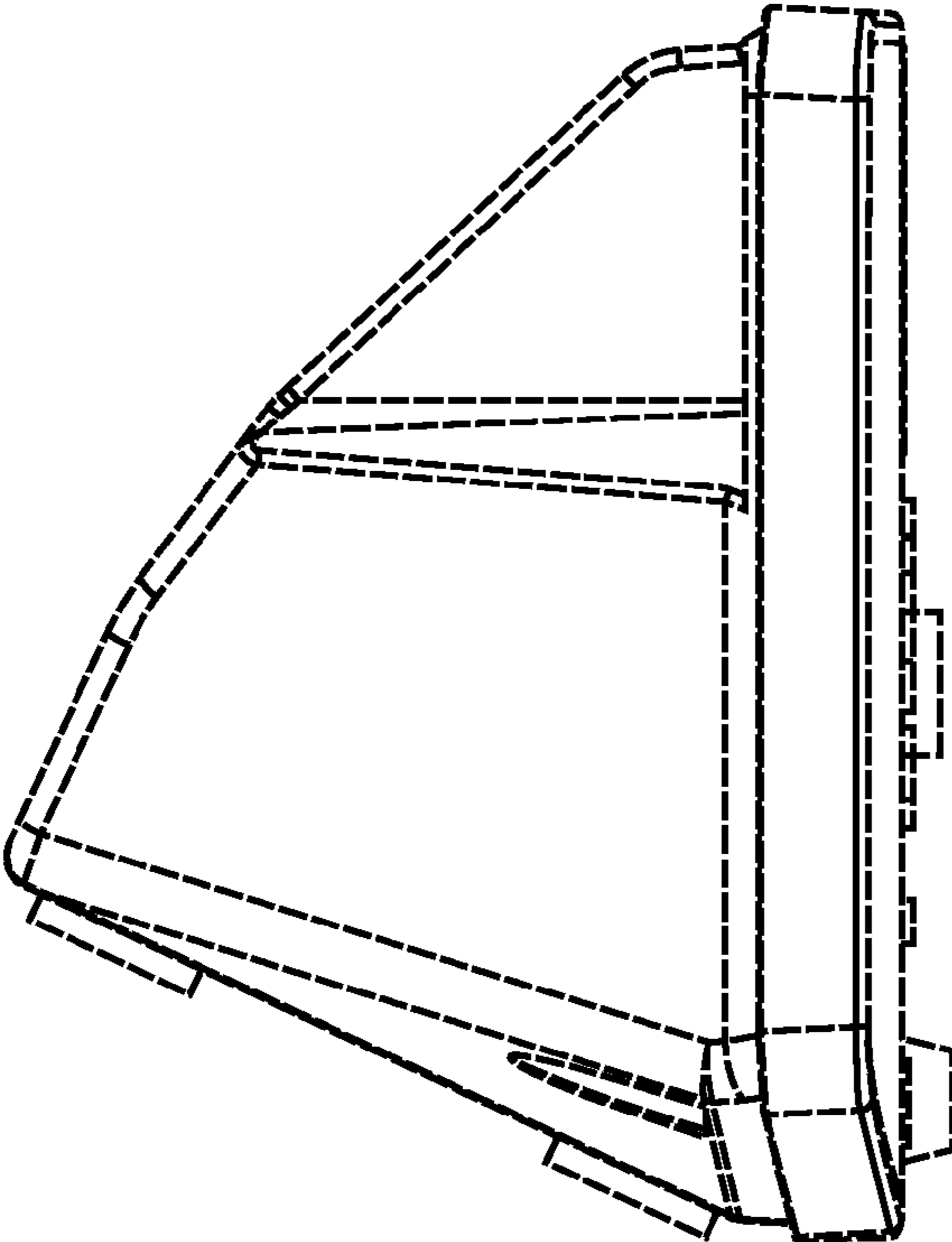

FIG. 6

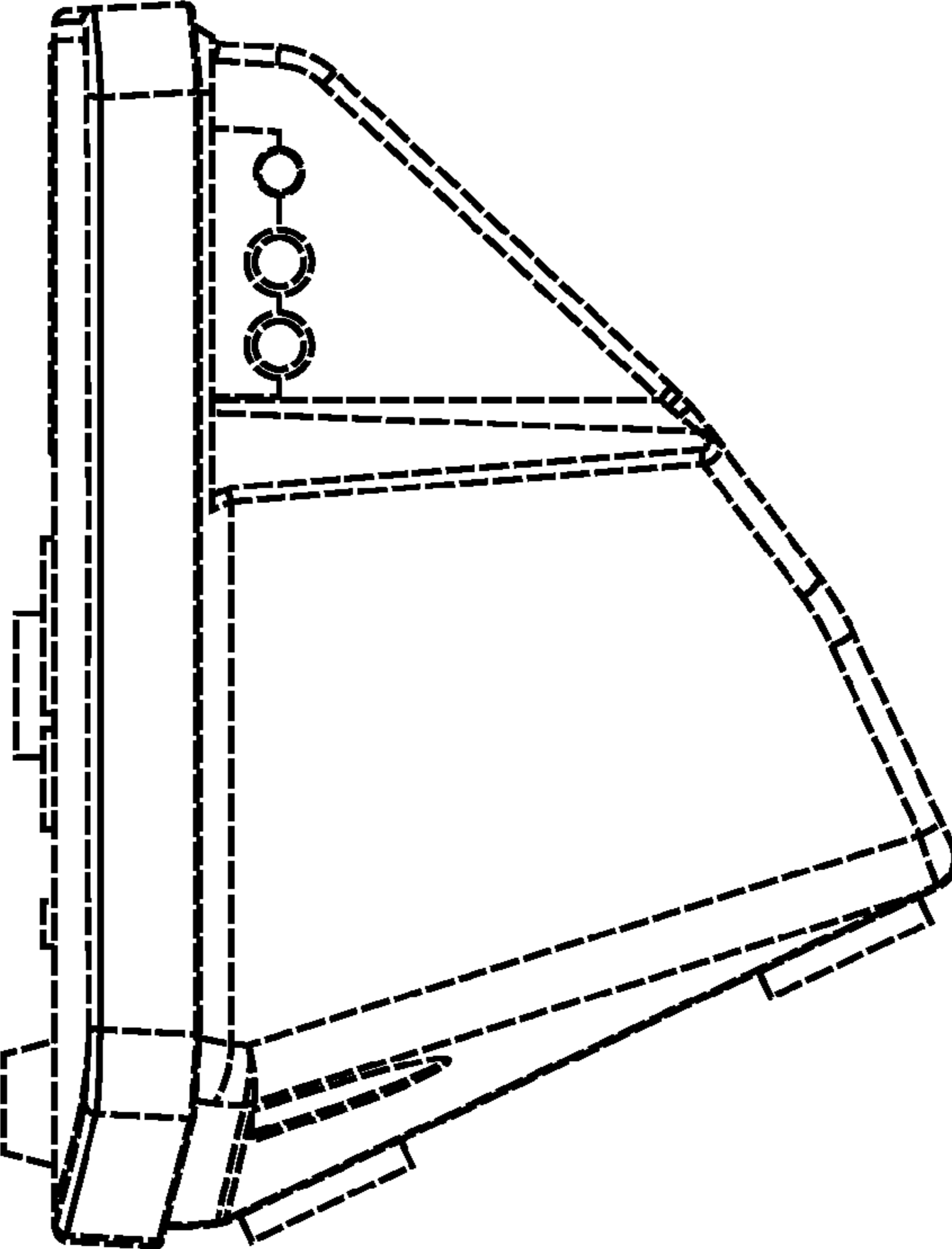

FIG. 7