



US00D637985S

(12) **United States Design Patent**
Andresen

(10) **Patent No.:** **US D637,985 S**

(45) **Date of Patent:** **** May 17, 2011**

(54) **ENDPOINT FOR VIDEO CONFERENCING**

(56) **References Cited**

(75) Inventor: **Simen Andresen**, Eiksmarka (NO)

U.S. PATENT DOCUMENTS

(73) Assignee: **Tandberg Telecom AS**, Lysaker (NO)

D403,670 S *	1/1999	Liao	D14/375
D461,785 S *	8/2002	Wilmotte	D14/126
D549,675 S *	8/2007	Yoon et al.	D14/126
D601,105 S *	9/2009	Morabito	D14/129
D609,662 S	2/2010	Noreng et al.	
D628,175 S *	11/2010	Desai et al.	D14/126

(**) Term: **14 Years**

* cited by examiner

(21) Appl. No.: **29/363,513**

(22) Filed: **Jun. 10, 2010**

Primary Examiner — Raphael Barkai

(30) **Foreign Application Priority Data**

(74) *Attorney, Agent, or Firm* — Oblon, Spivak, McClelland, Maier & Neustadt, L.L.P.

Dec. 11, 2009 (NO) 20090657

(57) **CLAIM**

(51) **LOC (9) Cl.** **14-03**

The ornamental design for an endpoint for video conferencing, as shown and described.

(52) **U.S. Cl.** **D14/129; D14/126**

DESCRIPTION

(58) **Field of Classification Search** D14/125–134, D14/239, 371, 136, 374–377, 440, 450, 448, D14/336, 342; 312/7.2; 348/836, 838, 180, 348/184, 325, 739; 341/12; 248/917–924, 248/465; 345/104, 133, 156, 168, 87, 173; 720/605, 669, 600, 655; 369/99, 197; 455/344, 455/347; D21/329, 515, 577, 622, 333, 433, D21/448, 452, 450, 331; D6/477, 479, 300; 273/148 B; 446/484, 175, 356; D10/15, D10/26

FIG. 1 is a front and left side perspective view of an endpoint for video conferencing;
 FIG. 2 is a rear, top, and right side perspective view thereof;
 FIG. 3 is a front elevational view thereof;
 FIG. 4 is a rear elevational view thereof;
 FIG. 5 is a top plan view thereof;
 FIG. 6 is a bottom plan view thereof;
 FIG. 7 is a right side elevational view thereof; and,
 FIG. 8 is a left side elevational view thereof.
 The broken lines in the drawings depict environmental subject matter only and form no part of the claimed design.

See application file for complete search history.

1 Claim, 8 Drawing Sheets

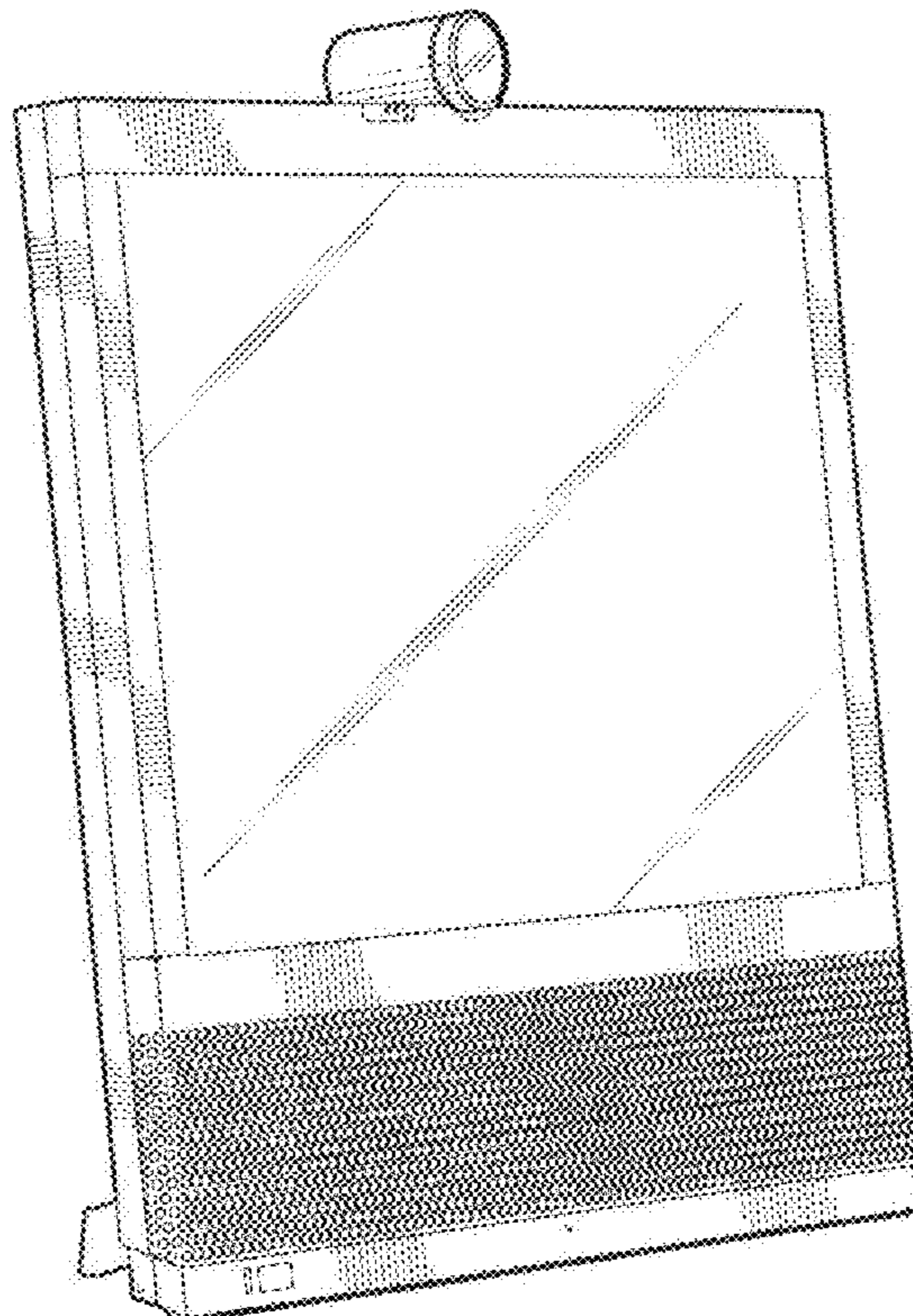

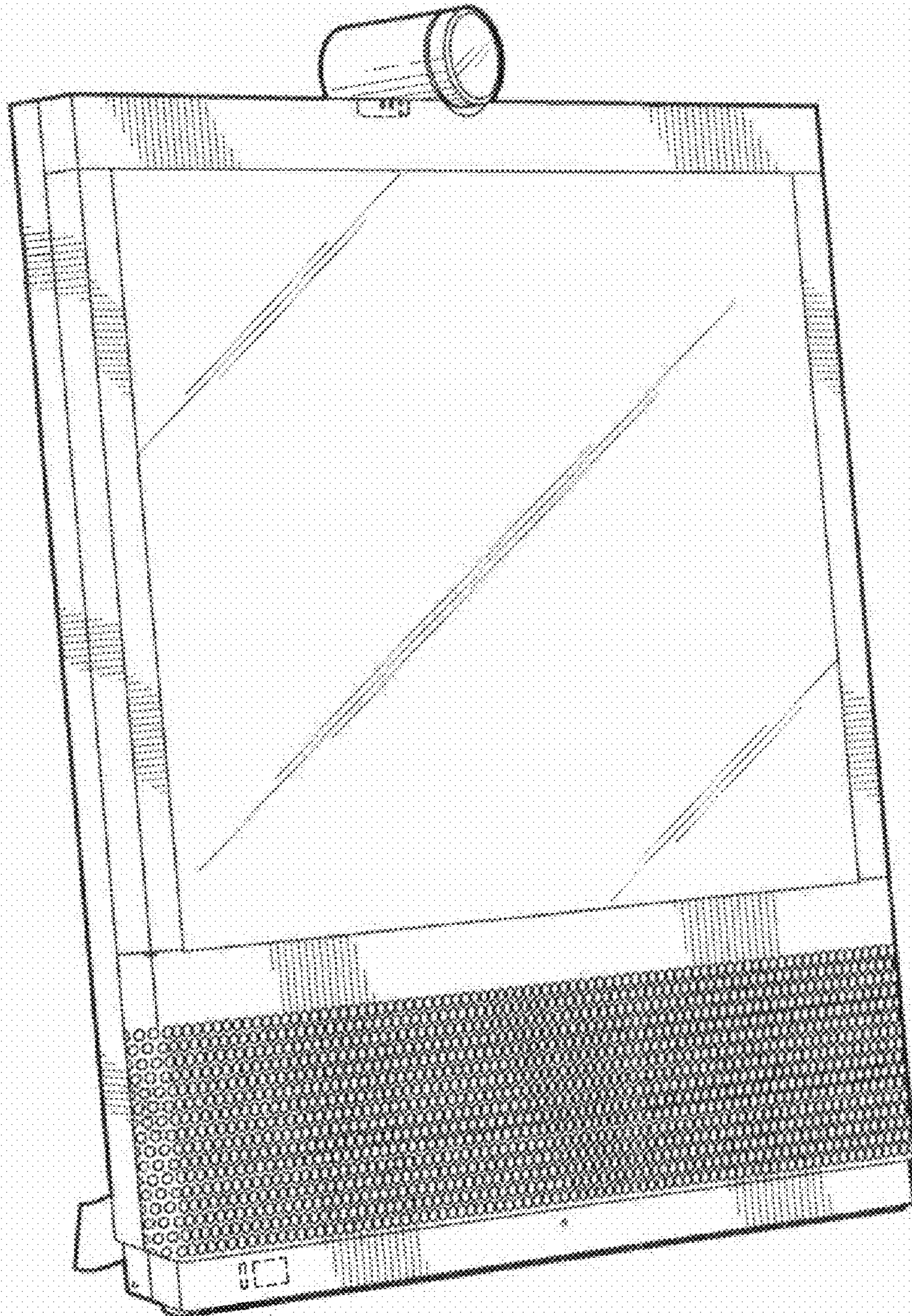

Fig. 1

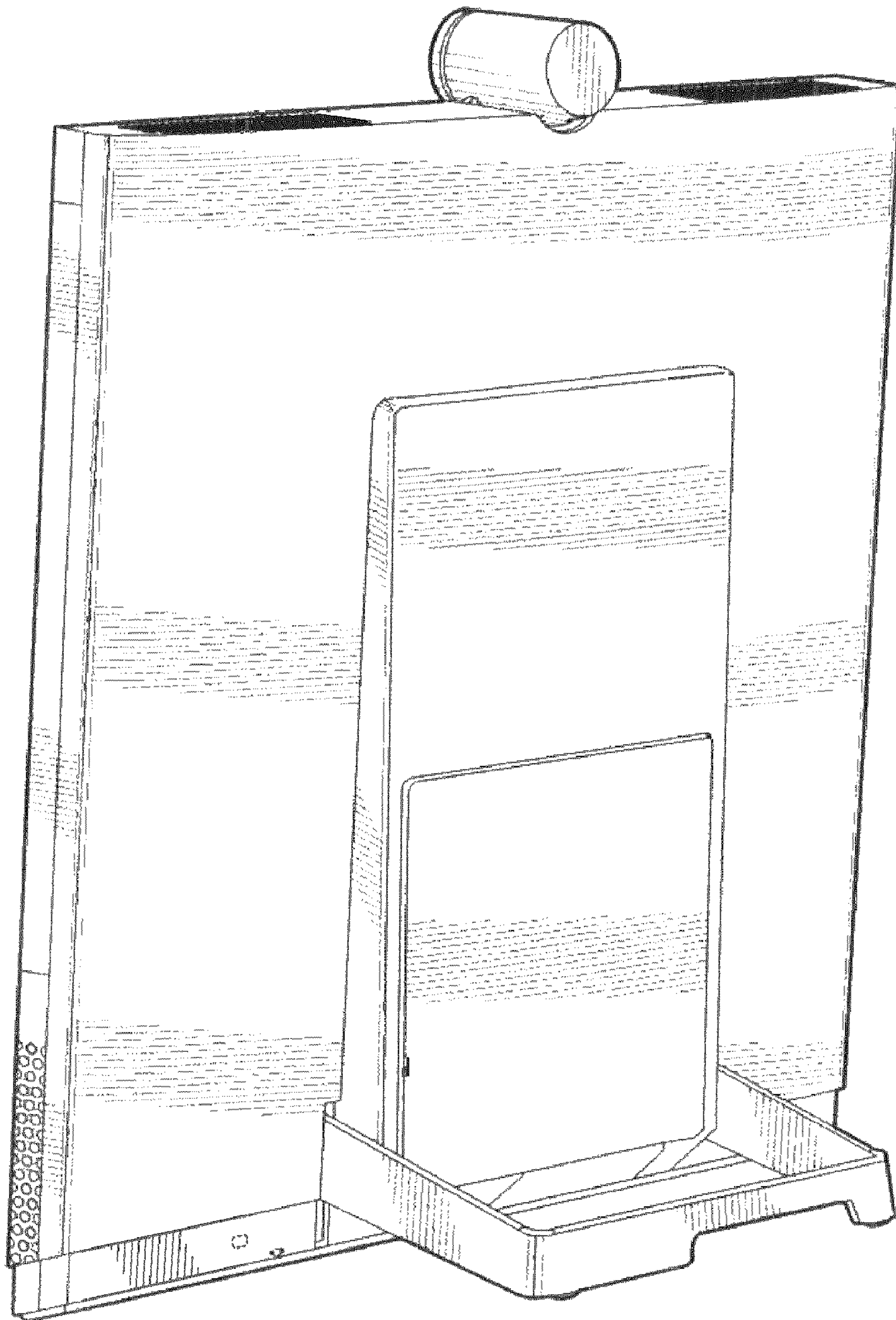

Fig. 2

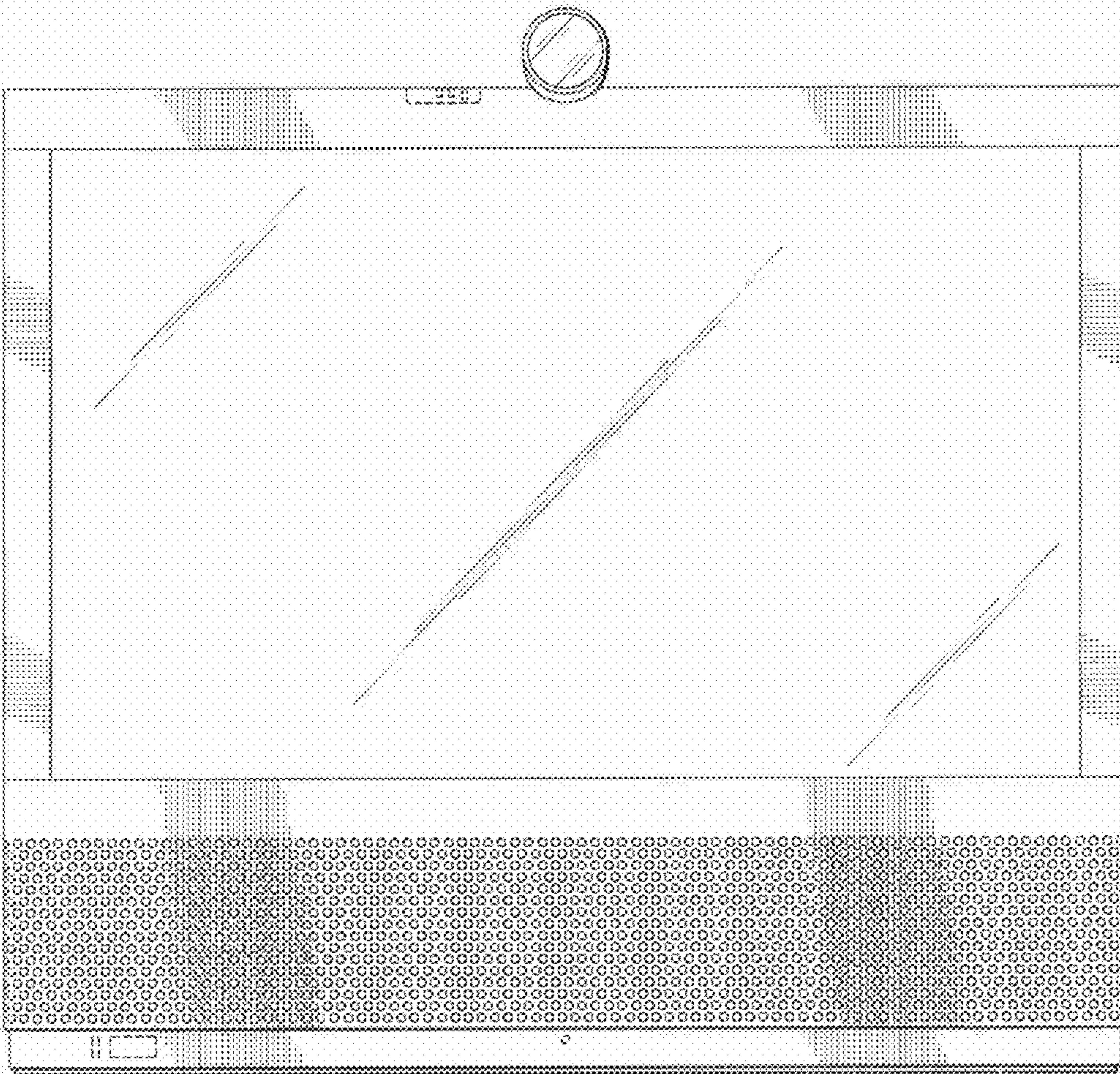

Fig. 3

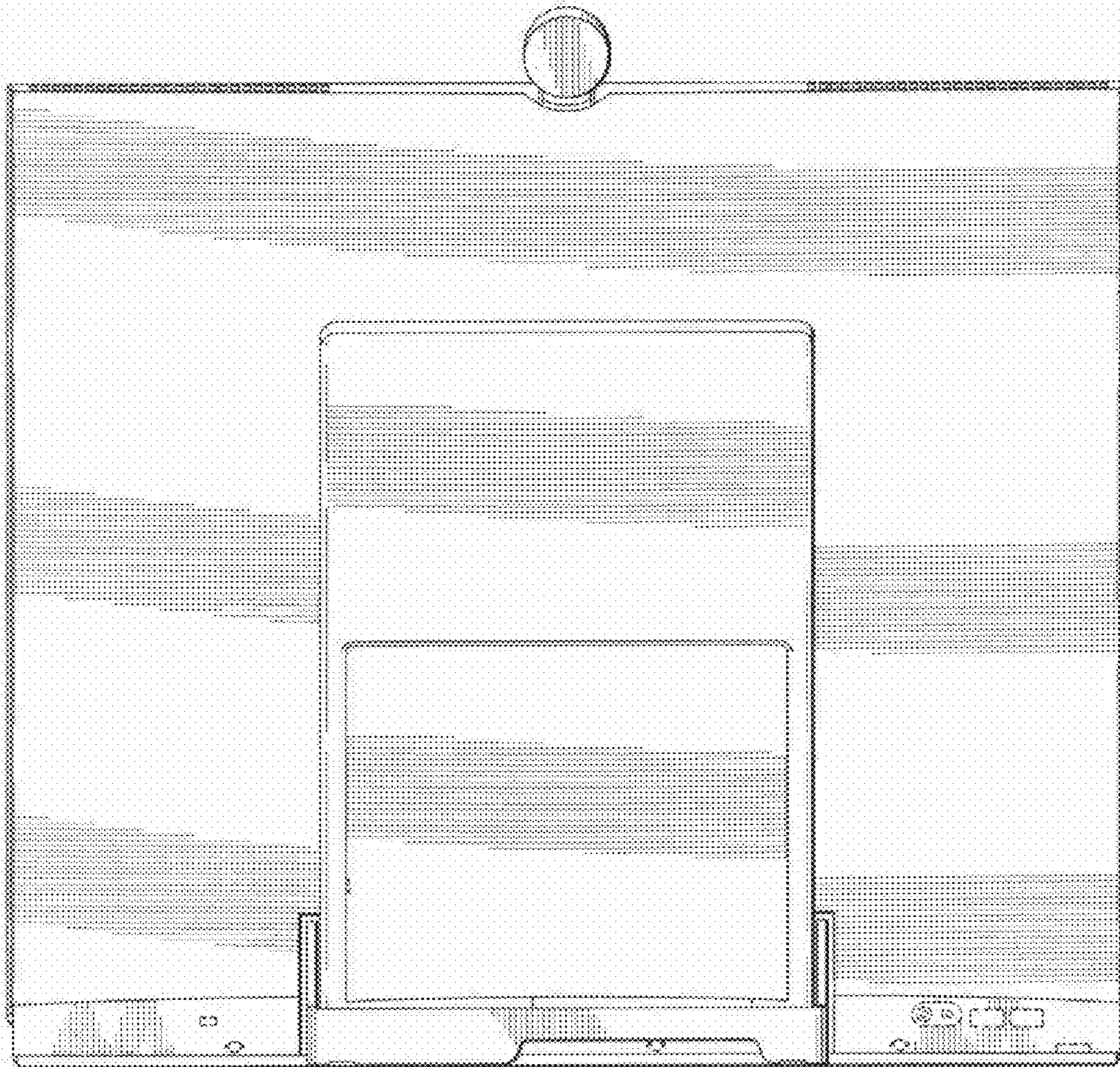

Fig. 4

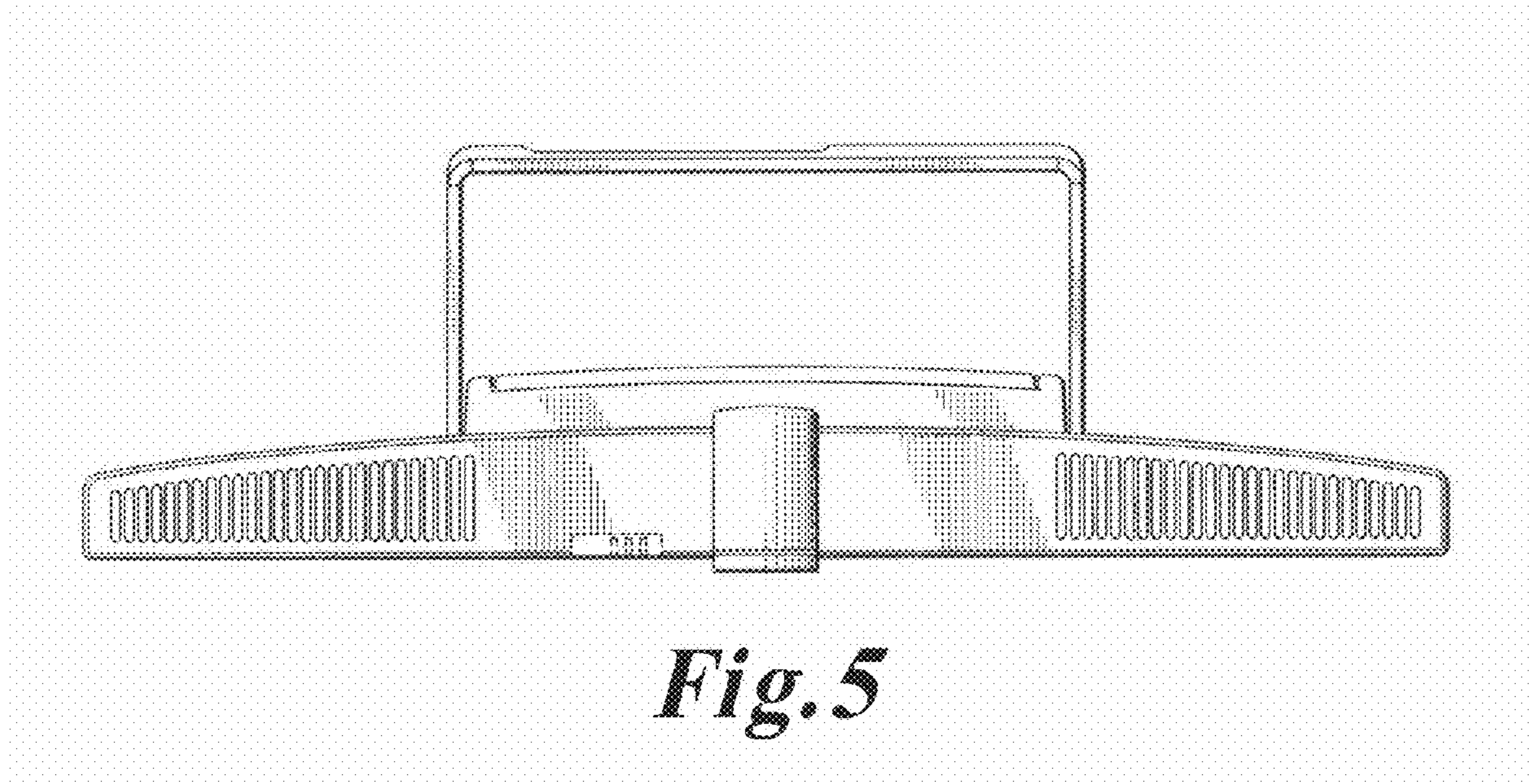

Fig. 5

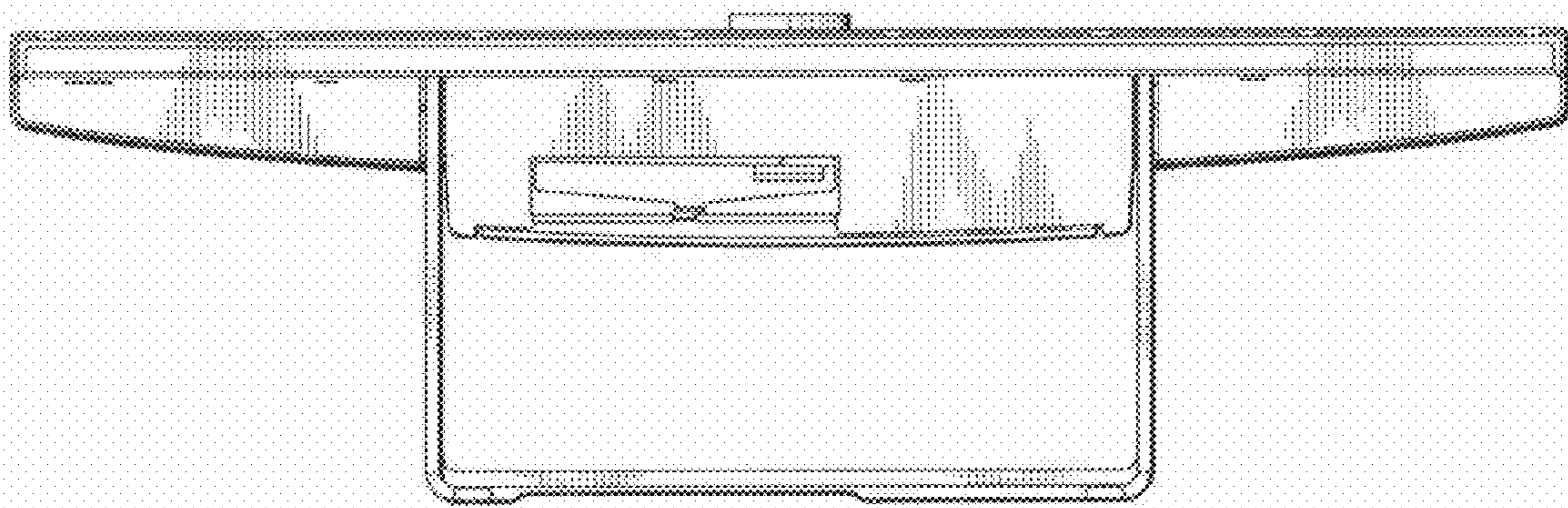

Fig. 6

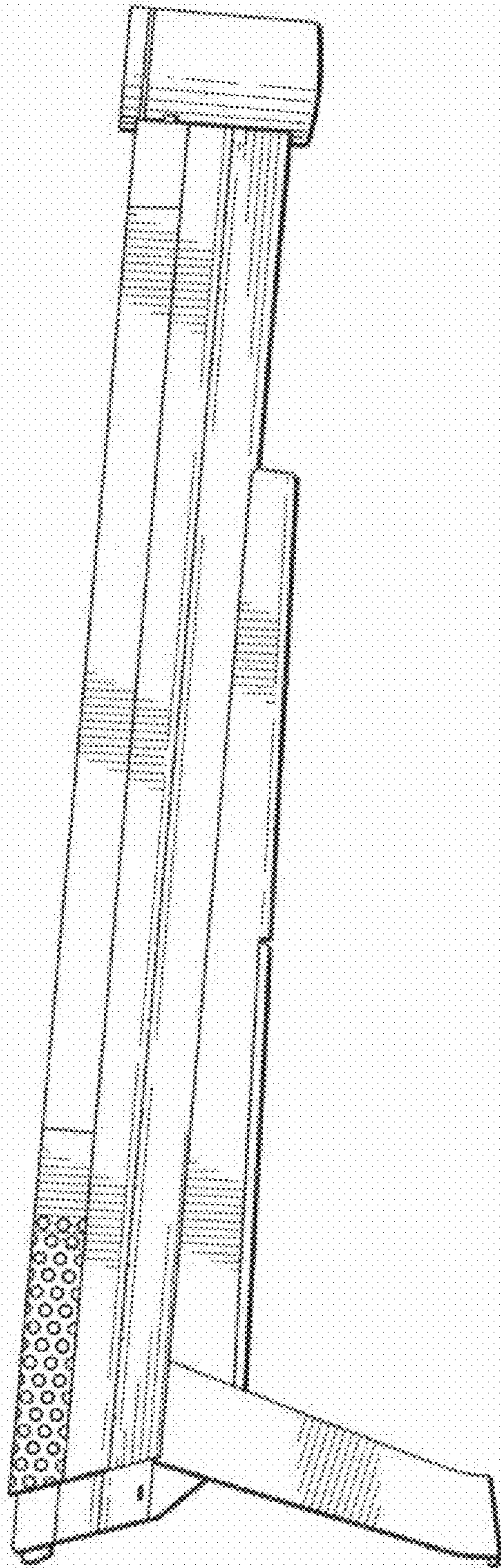

Fig. 7

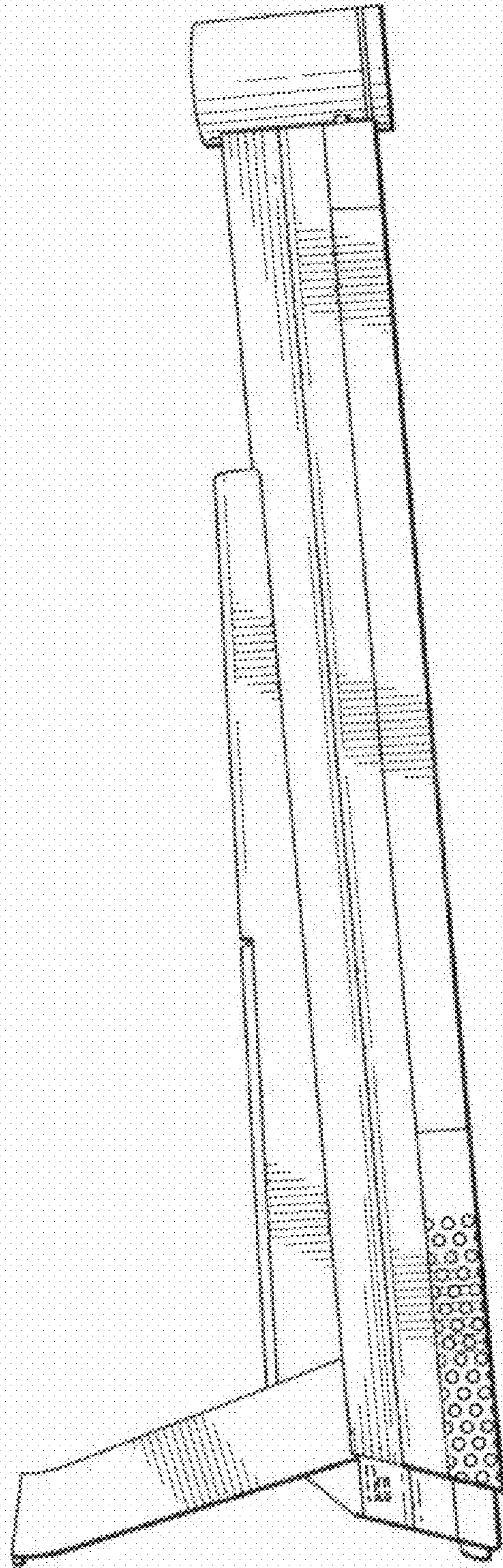

Fig. 8