

US00D637941S

(12) **United States Design Patent**  
**Paik**

(10) **Patent No.:** **US D637,941 S**

(45) **Date of Patent:** **\*\* May 17, 2011**

(54) **FEMALE RECEPTACLE OF CROSS-SHAPED BUCKLE**

D576,074 S \* 9/2008 Yoshiguchi ..... D11/216  
D576,519 S \* 9/2008 Uehara ..... D11/216  
D576,672 S \* 9/2008 Zdimal ..... D19/20  
D619,496 S \* 7/2010 Paik ..... D11/216

(76) Inventor: **Jisook Paik**, Seoul (KR)

\* cited by examiner

(\*\*) Term: **14 Years**

*Primary Examiner* — Ralf Seifert

(21) Appl. No.: **29/368,240**

(74) *Attorney, Agent, or Firm* — Kile Park Goekjian Reed & McManus PLLC

(22) Filed: **Aug. 20, 2010**

(30) **Foreign Application Priority Data**

Jul. 15, 2010 (KR) ..... 30-2010-0031069

(51) **LOC (9) Cl.** ..... **02-07**

(52) **U.S. Cl.** ..... **D11/216**

(58) **Field of Classification Search** ..... D11/1-2,  
D11/200-201, 206-210, 214-218; 24/163 R,  
24/169-171, 173, 177-179, 191, 194-195,  
24/197, 200

See application file for complete search history.

(56) **References Cited**

**U.S. PATENT DOCUMENTS**

D543,897 S \* 6/2007 Anscher ..... D11/218  
D566,003 S \* 4/2008 Anscher ..... D11/216

(57) **CLAIM**

I claim, the ornamental design for a female receptacle of cross-shaped buckle, as shown and described.

**DESCRIPTION**

FIG. 1 is a perspective view of a female receptacle of cross-shaped buckle, showing my new design; FIG. 2 is a front elevational view thereof; FIG. 3 is a rear elevational view thereof; FIG. 4 is a left side elevational view thereof; FIG. 5 is a right side elevational view thereof; FIG. 6 is a top plan view thereof; FIG. 7 is a bottom plan view thereof; and, FIG. 8 is a cross-sectional view thereof taken along line '8-8' in FIG. 2.

**1 Claim, 4 Drawing Sheets**

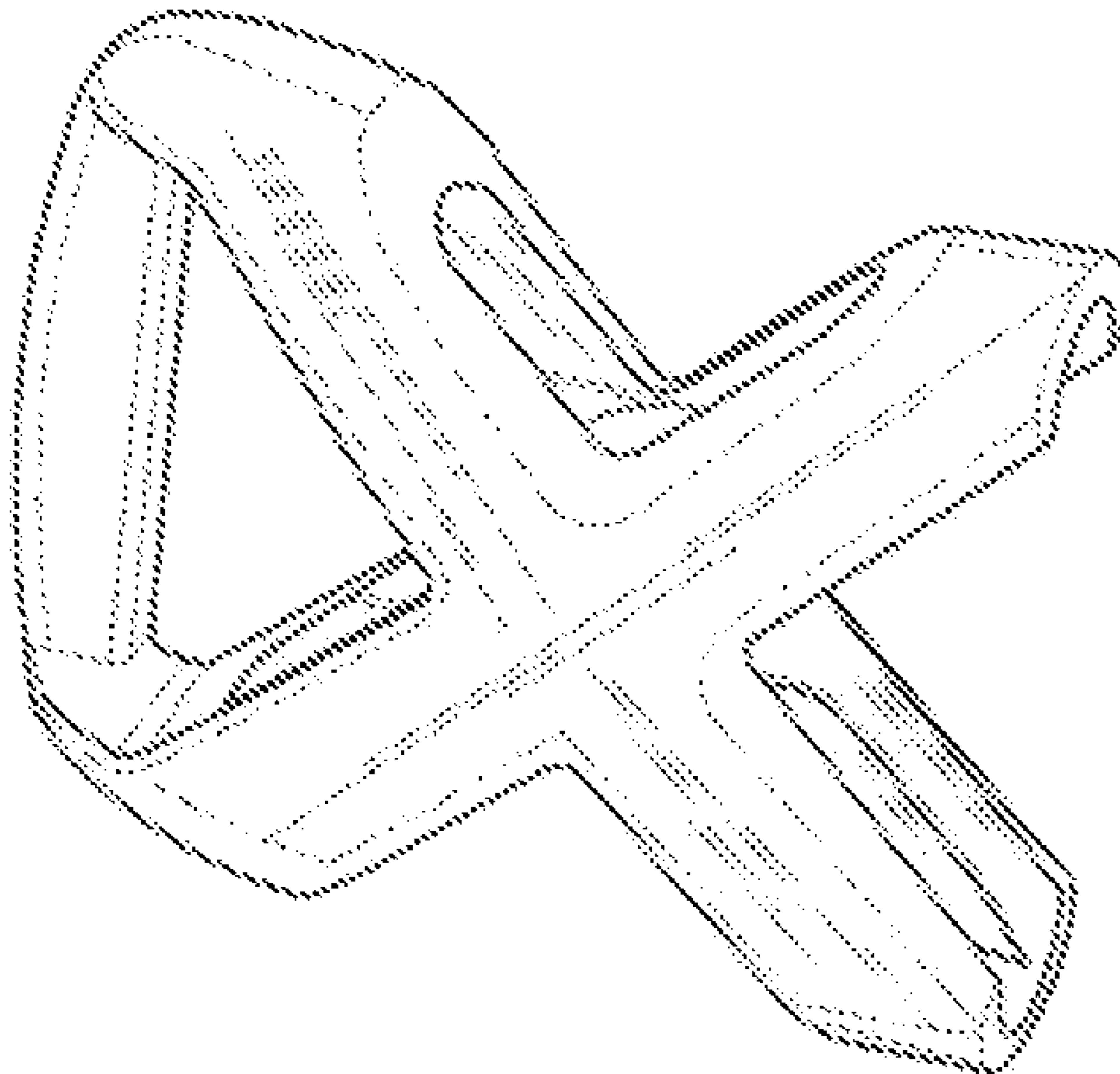

Fig. 1

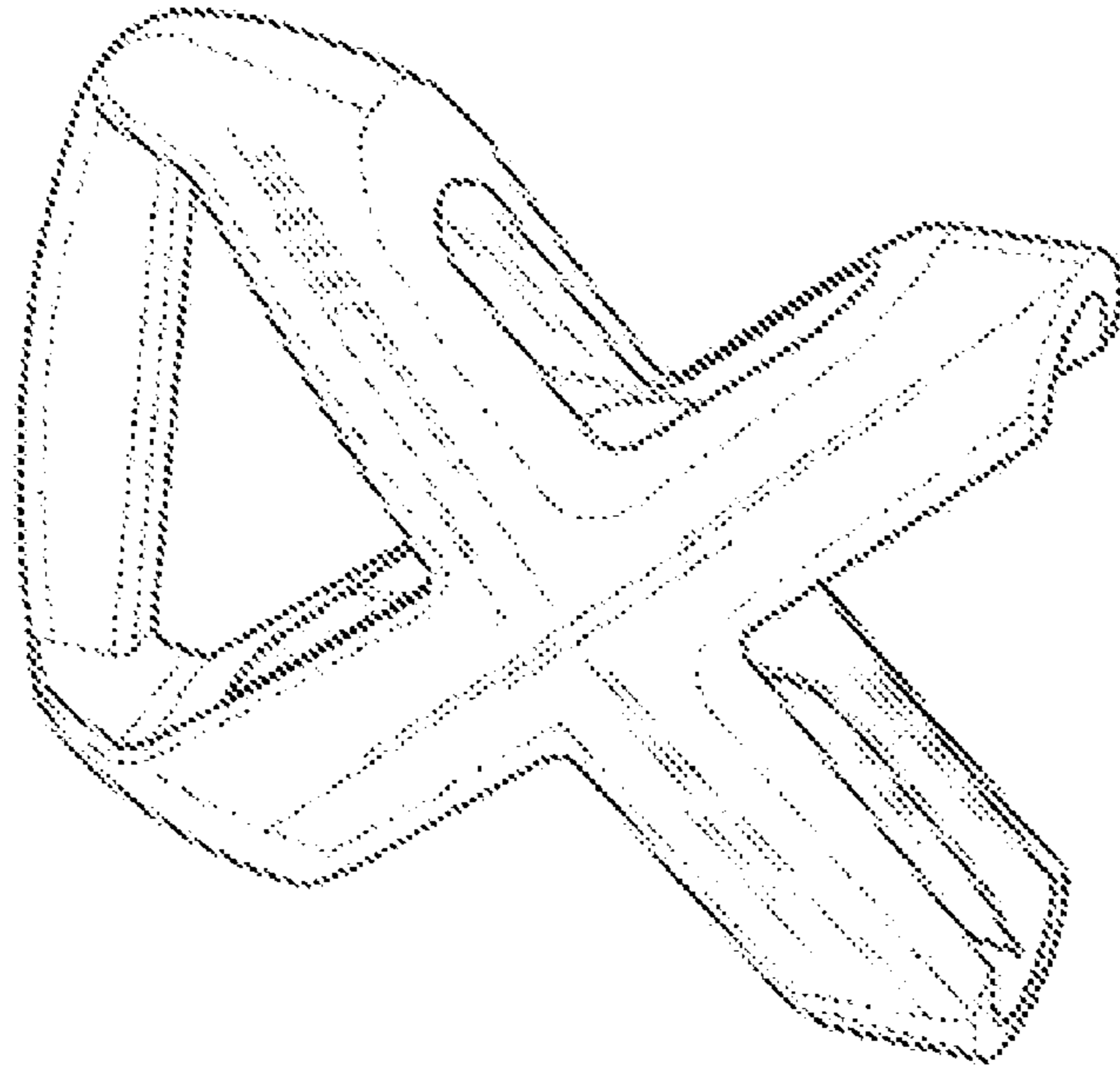

Fig. 2

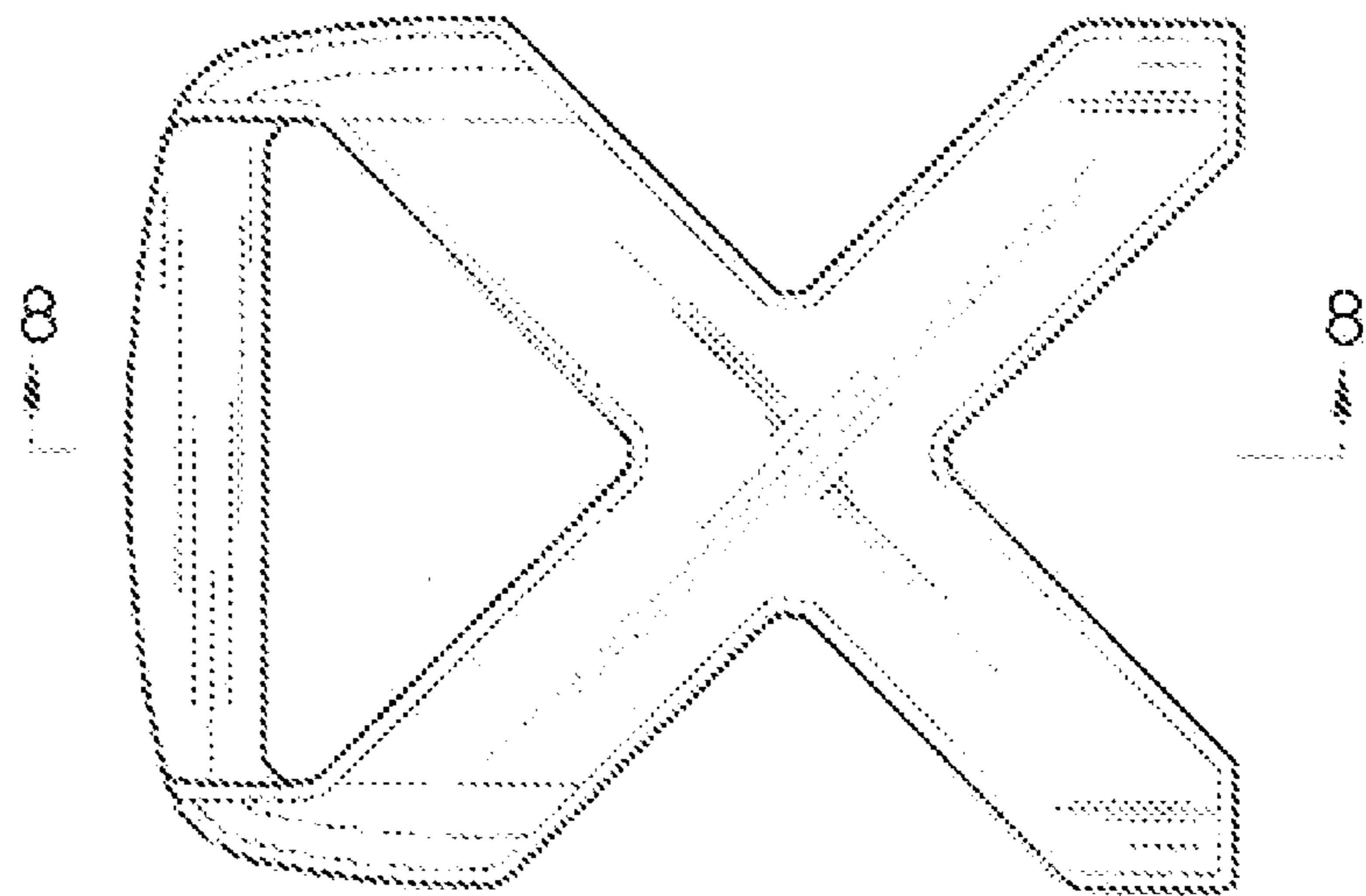

Fig. 3

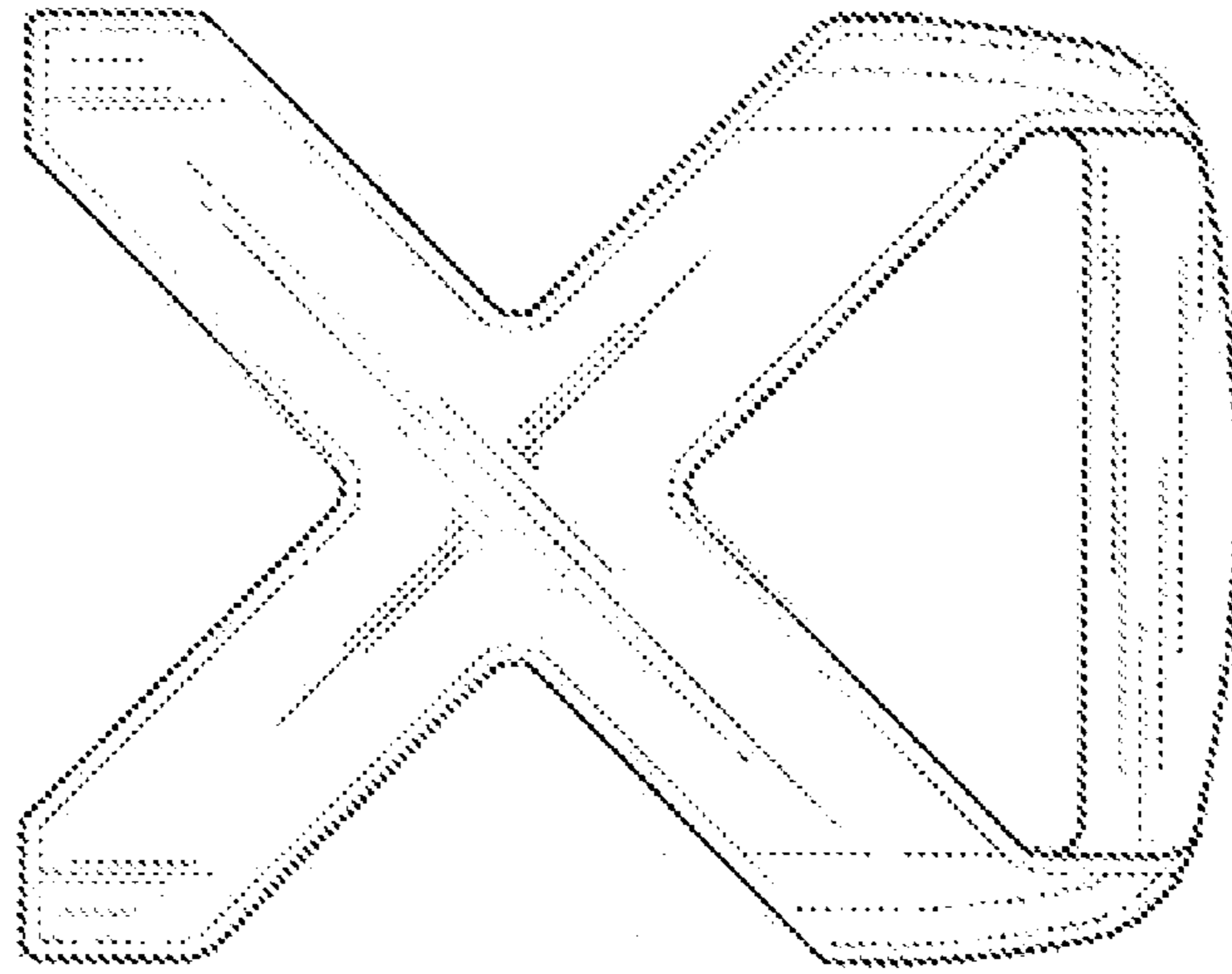

Fig. 4

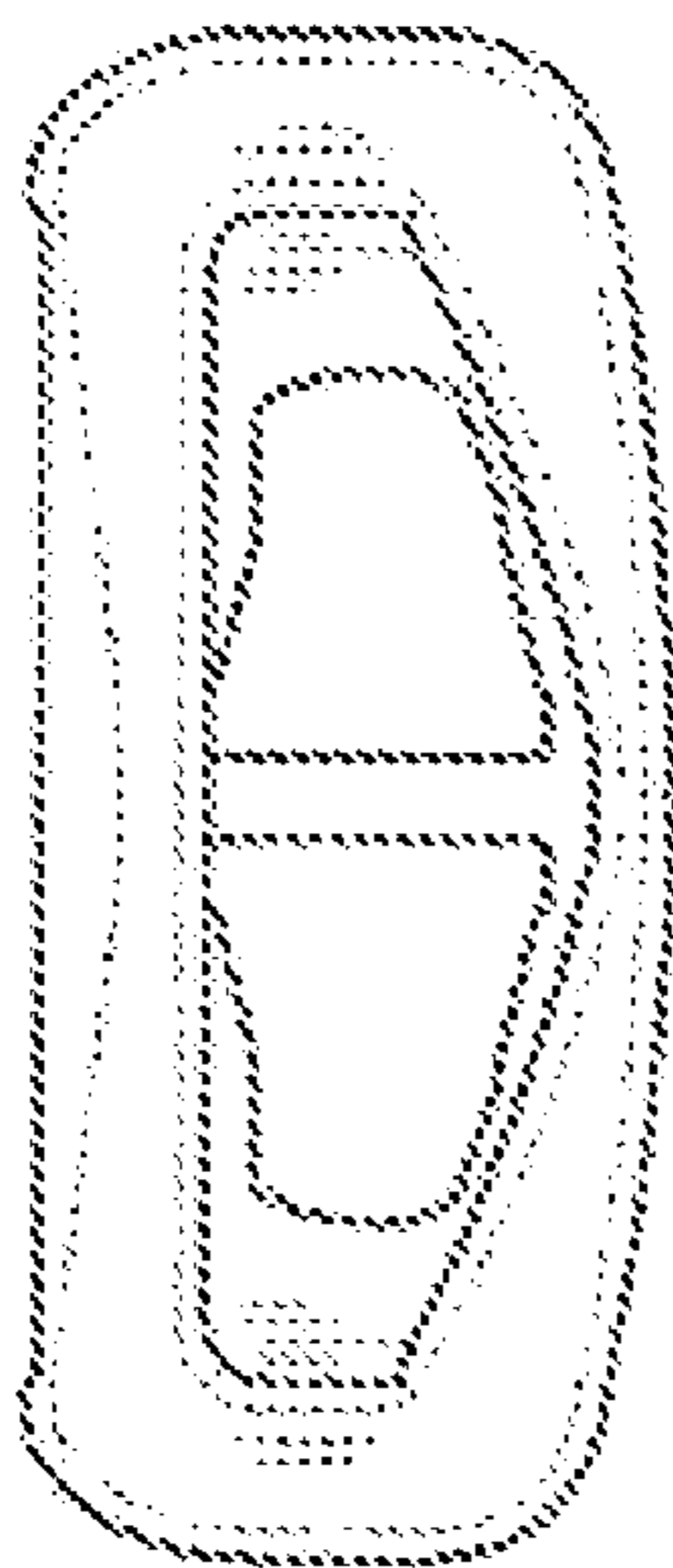

Fig. 5

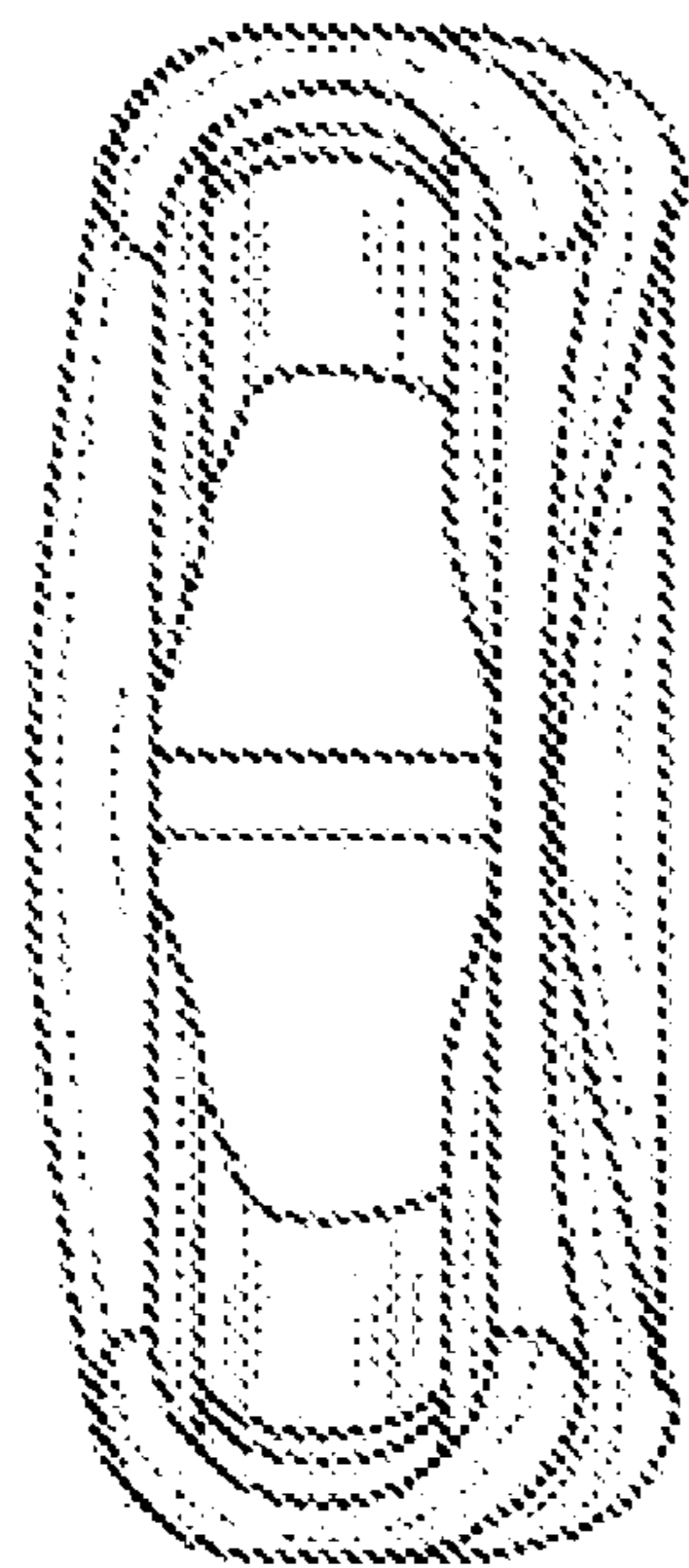

Fig. 6

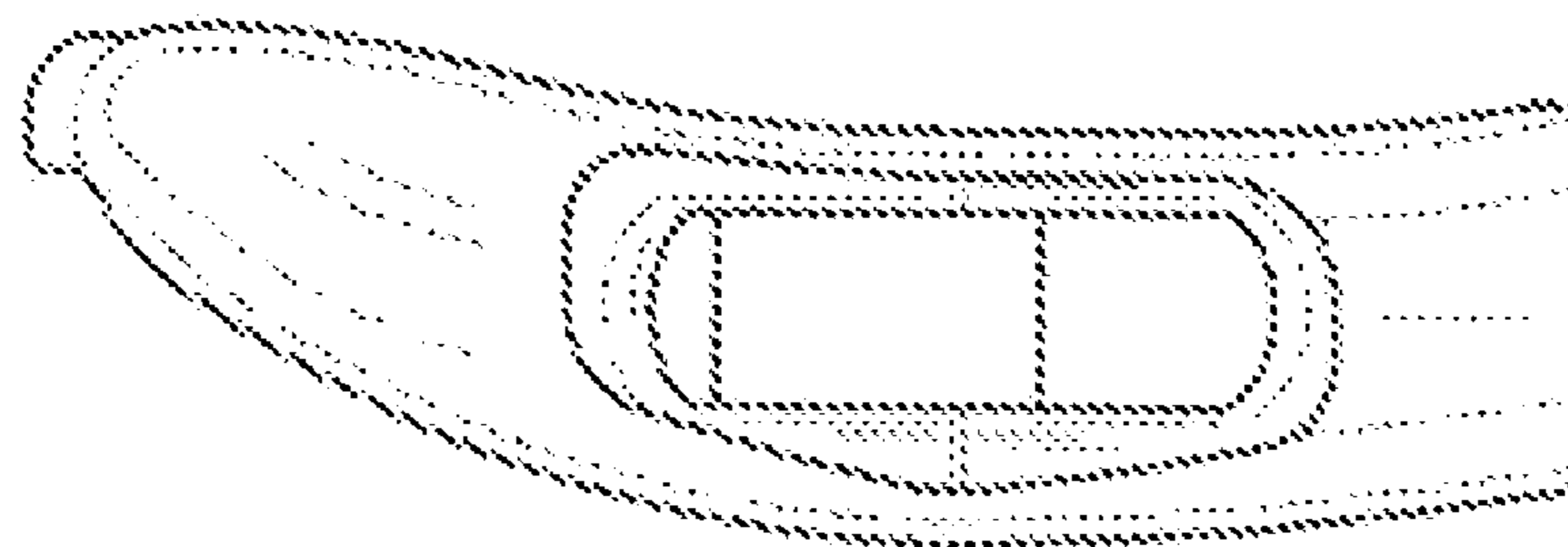

Fig. 7

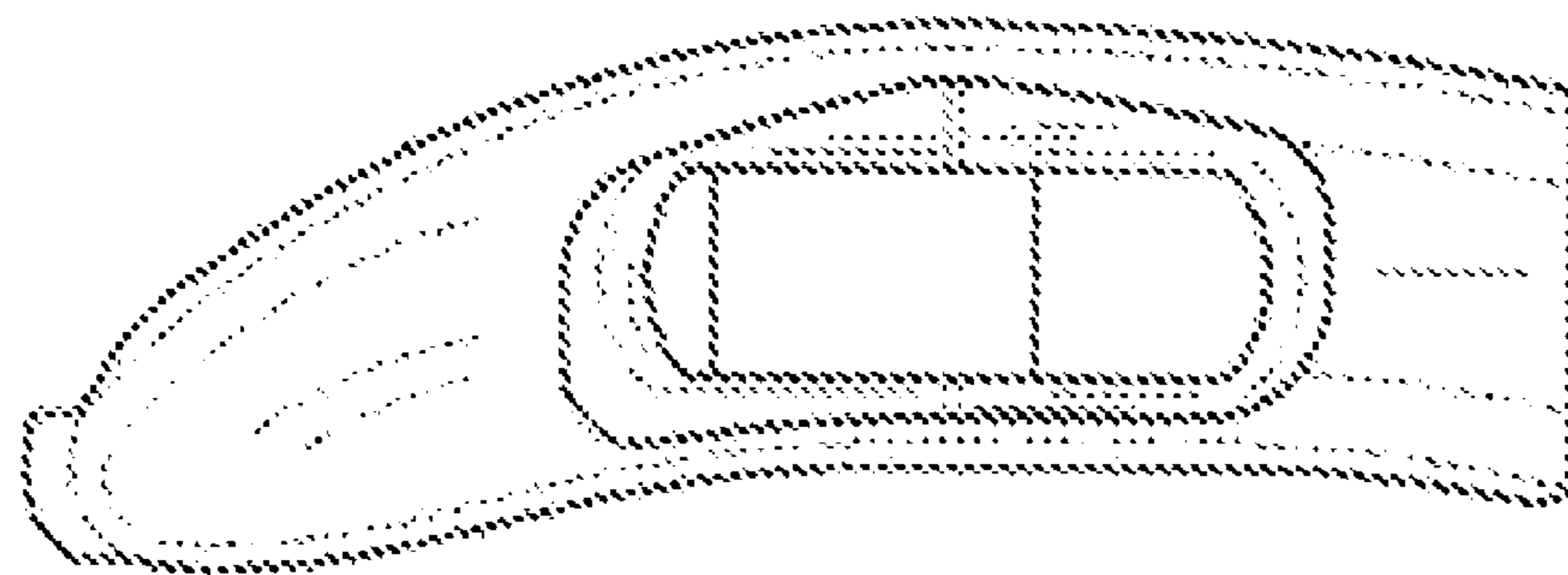

Fig. 8

