



US00D637885S

(12) **United States Design Patent**  
**Buck**

(10) **Patent No.:** **US D637,885 S**

(45) **Date of Patent:** **\*\* May 17, 2011**

(54) **DOOR HANDLE ASSEMBLY**

(76) Inventor: **John Buck**, Camarillo, CA (US)

(\*\*) Term: **14 Years**

(21) Appl. No.: **29/384,818**

(22) Filed: **Feb. 4, 2011**

(51) **LOC (9) Cl.** ..... **08-06**

(52) **U.S. Cl.** ..... **D8/308**

(58) **Field of Classification Search** ..... D8/300,  
D8/302, 306, 308, 315, 321, 341, 354, 338,  
D8/309, DIG. 1, DIG. 10; 16/110.1, 412,  
16/413, 430, 901; 292/336.3, DIG. 31; D2/641,  
D2/642; D6/320, 512, 580, 578, 540, 546;  
D21/673, 693

See application file for complete search history.

(56) **References Cited**

**U.S. PATENT DOCUMENTS**

D165,976 S *	2/1952	Goserud	.....	D8/341
D179,417 S *	12/1956	Greenwood	.....	D8/338
D180,515 S *	6/1957	Graves et al.	.....	D8/341
3,121,907 A *	2/1964	Stebbins	.....	16/412
3,144,268 A *	8/1964	Rowe	.....	292/336.3
D203,868 S *	2/1966	Bourgeois	.....	D8/341
D204,235 S *	4/1966	Elder	.....	D8/314

3,965,528 A *	6/1976	Kissler	.....	16/110.1
4,644,689 A *	2/1987	Arians	.....	49/70
D343,541 S *	1/1994	Kassraie	.....	D6/580
5,983,454 A *	11/1999	Hartselle, III	.....	16/412
D439,292 S *	3/2001	Webber et al.	.....	D21/694
6,289,557 B1 *	9/2001	Manson et al.	.....	16/412
D465,719 S *	11/2002	Ditzig et al.	.....	D8/321
7,716,789 B1 *	5/2010	Zevallos	.....	16/412

\* cited by examiner

*Primary Examiner* — Paula Greene

(74) *Attorney, Agent, or Firm* — Ralph D. Chabot

(57) **CLAIM**

The ornamental design for a door handle assembly, as shown and described.

**DESCRIPTION**

FIG. 1—Top, front, left side perspective view

FIG. 2—Front elevation view

FIG. 3—Left side elevation view

FIG. 4—Rear elevation view

FIG. 5—Right side elevation view

FIG. 6—Top plan view

FIG. 7—Bottom plan view; and,

FIG. 8—Top, front, left side perspective view in an alternate position.

**1 Claim, 3 Drawing Sheets**

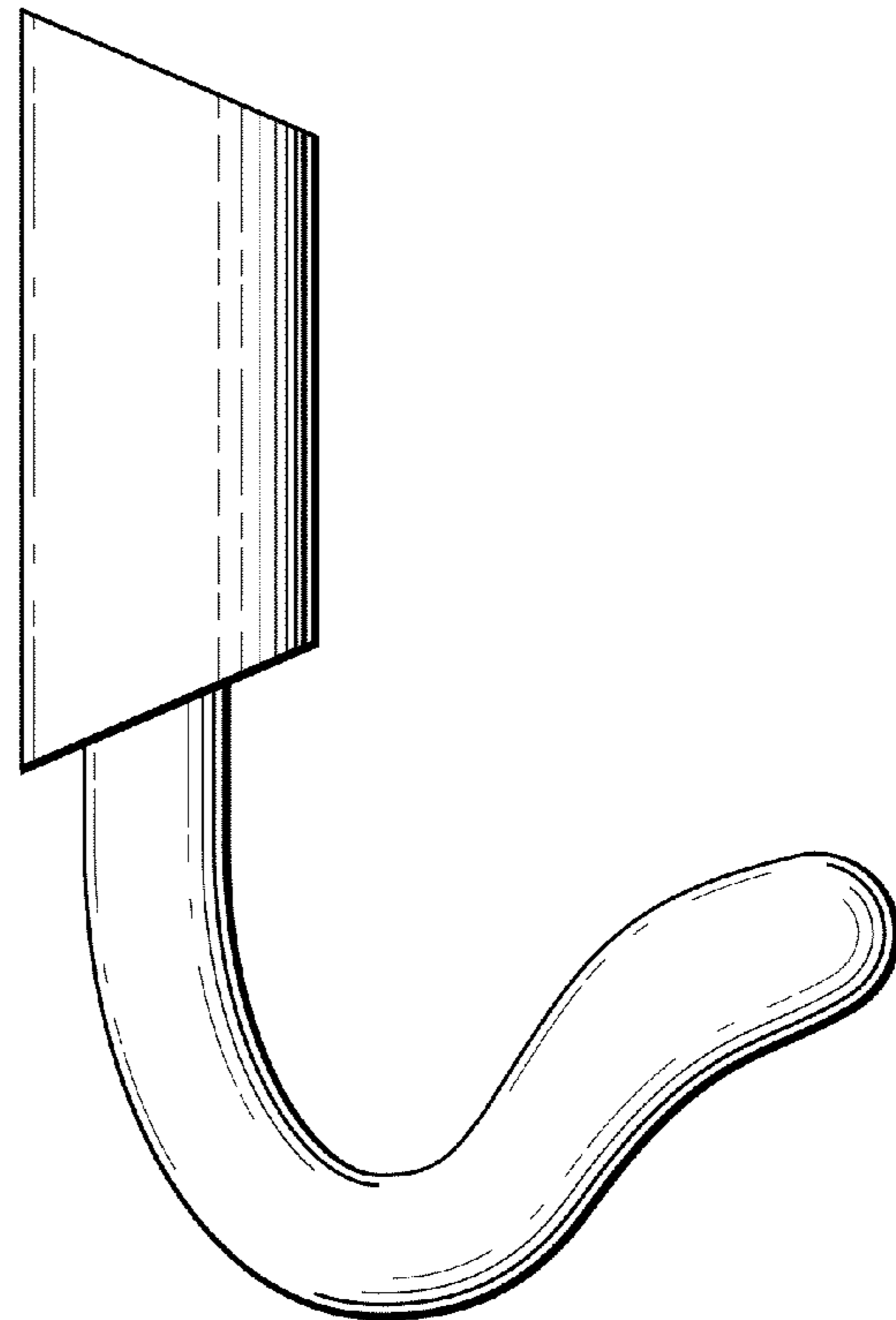
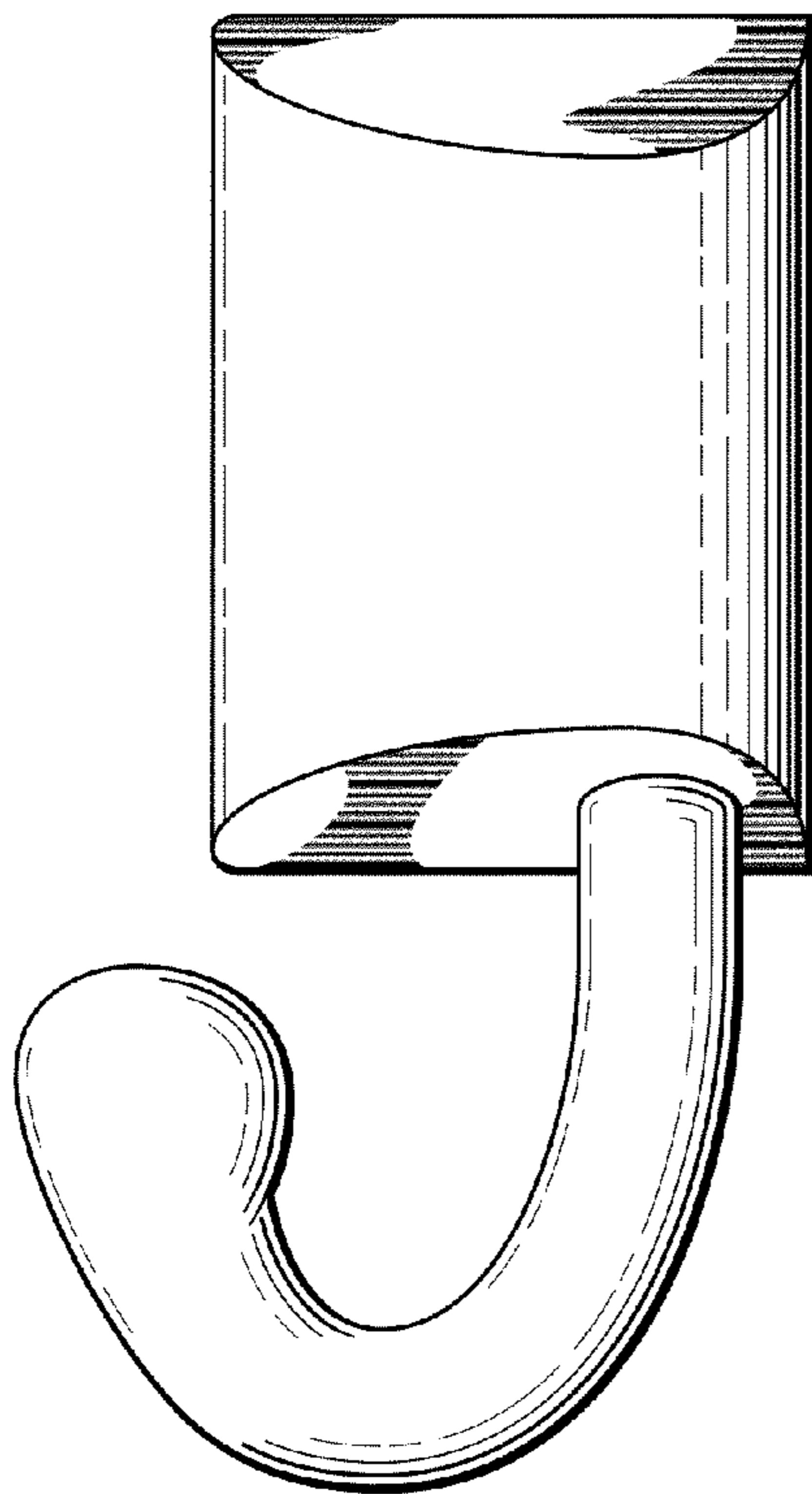

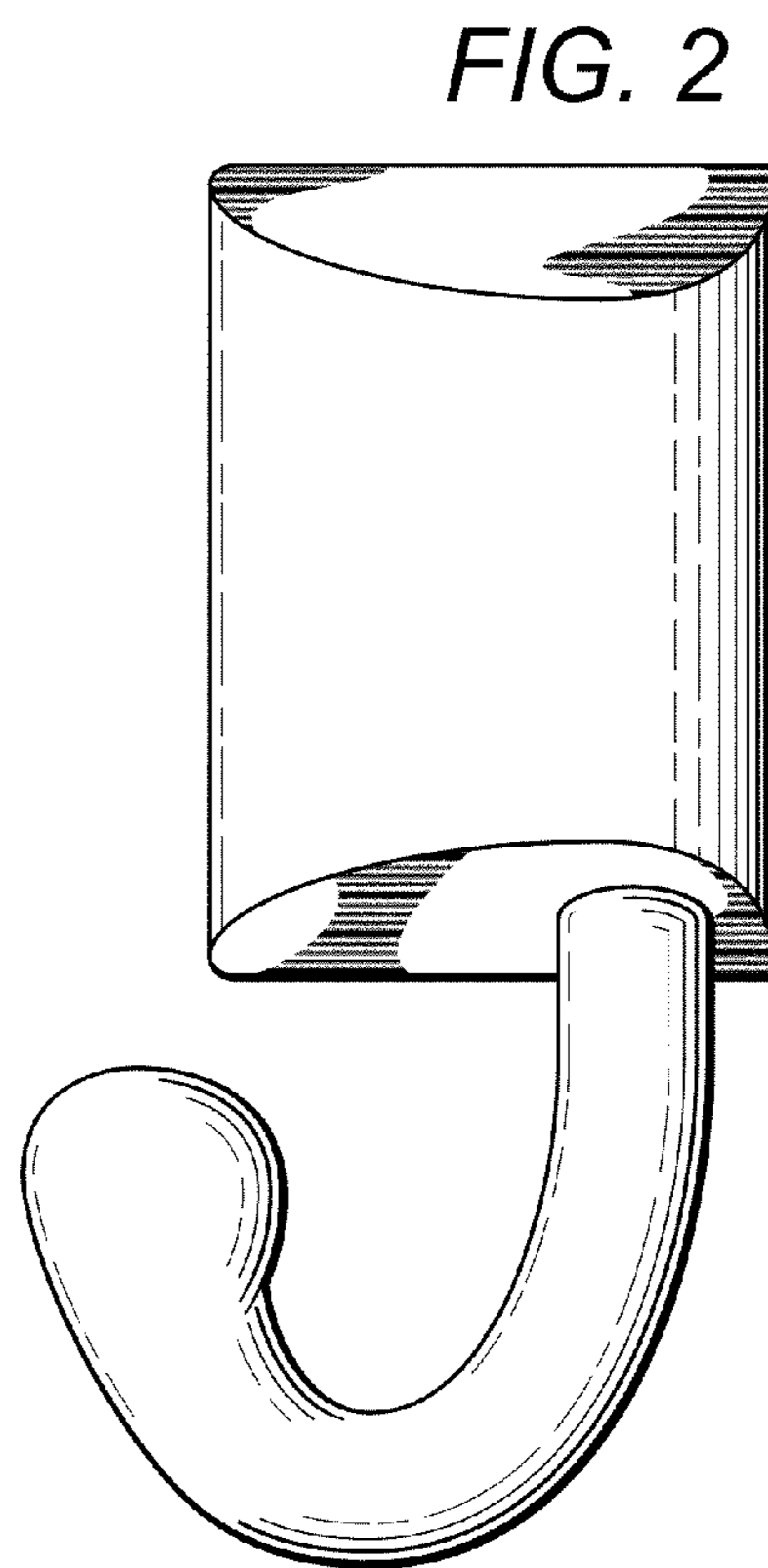
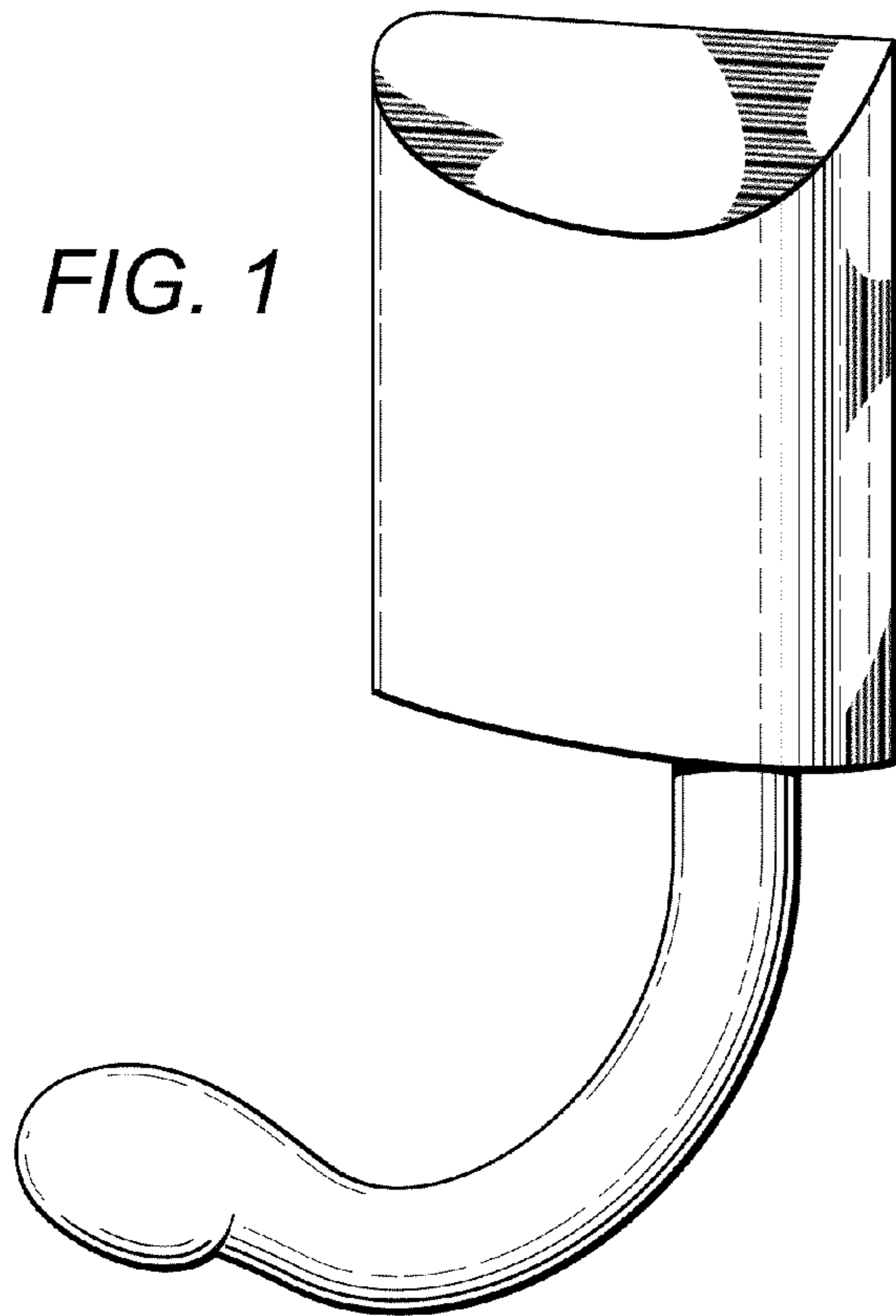

FIG. 3

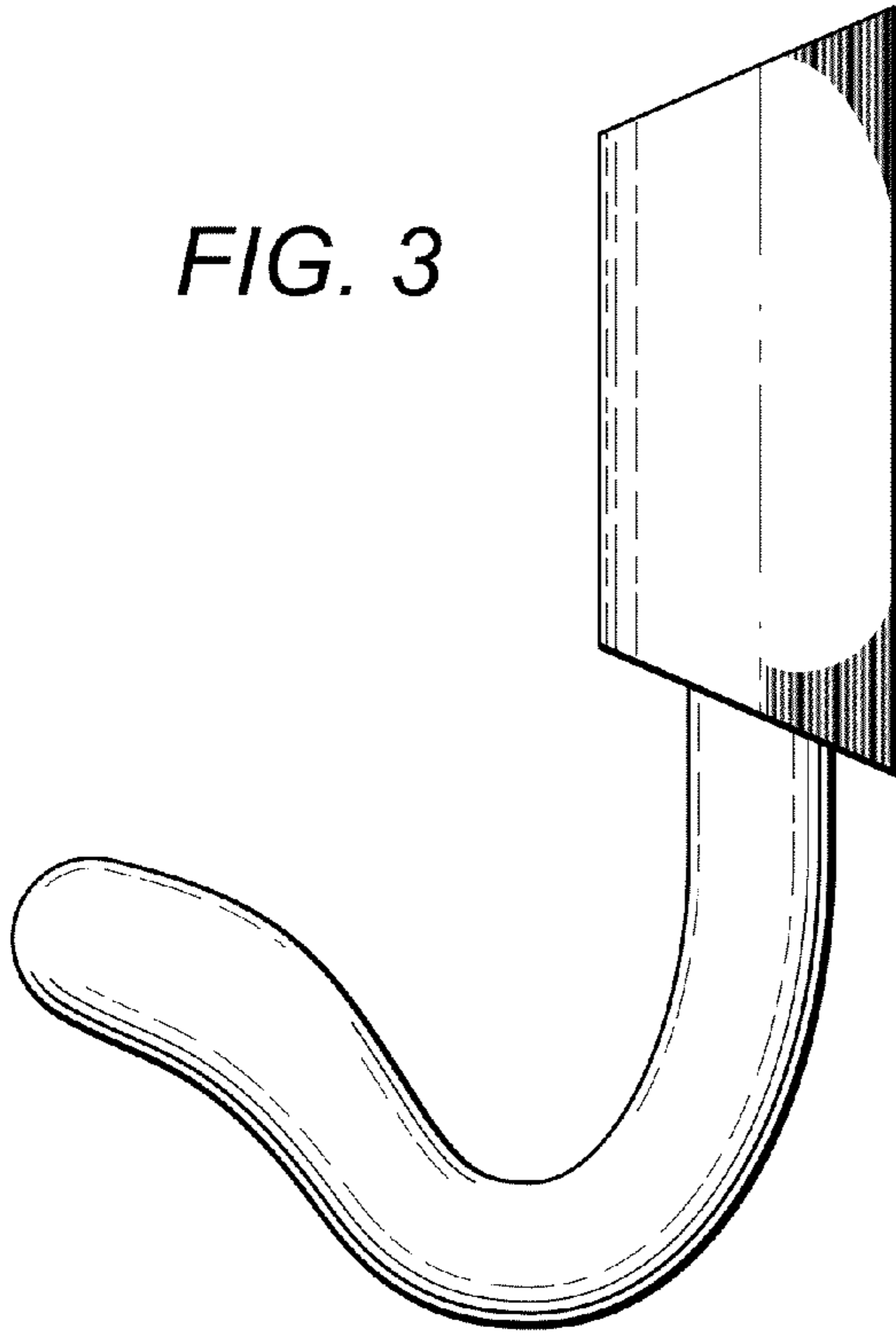

FIG. 4

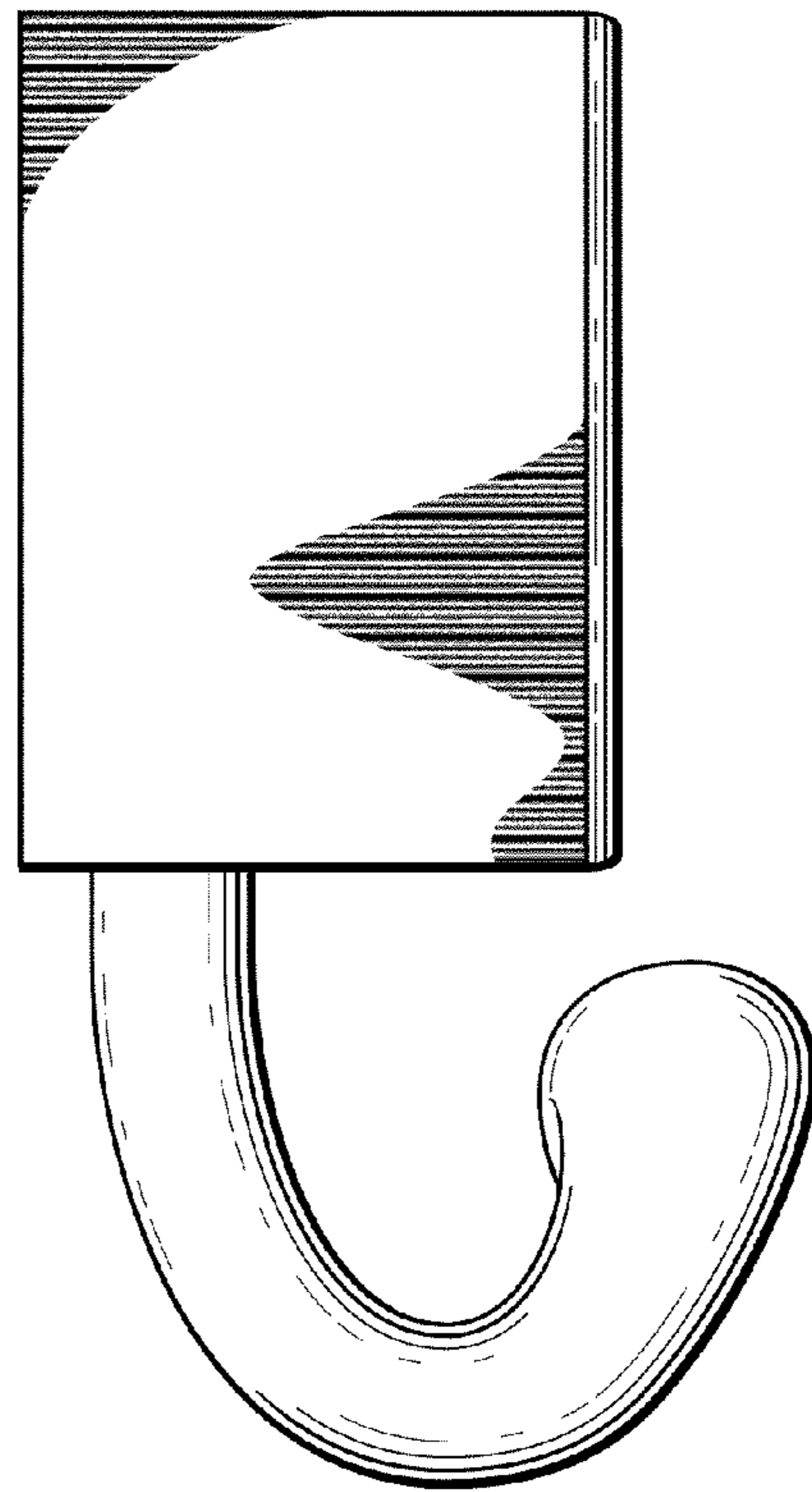

FIG. 5

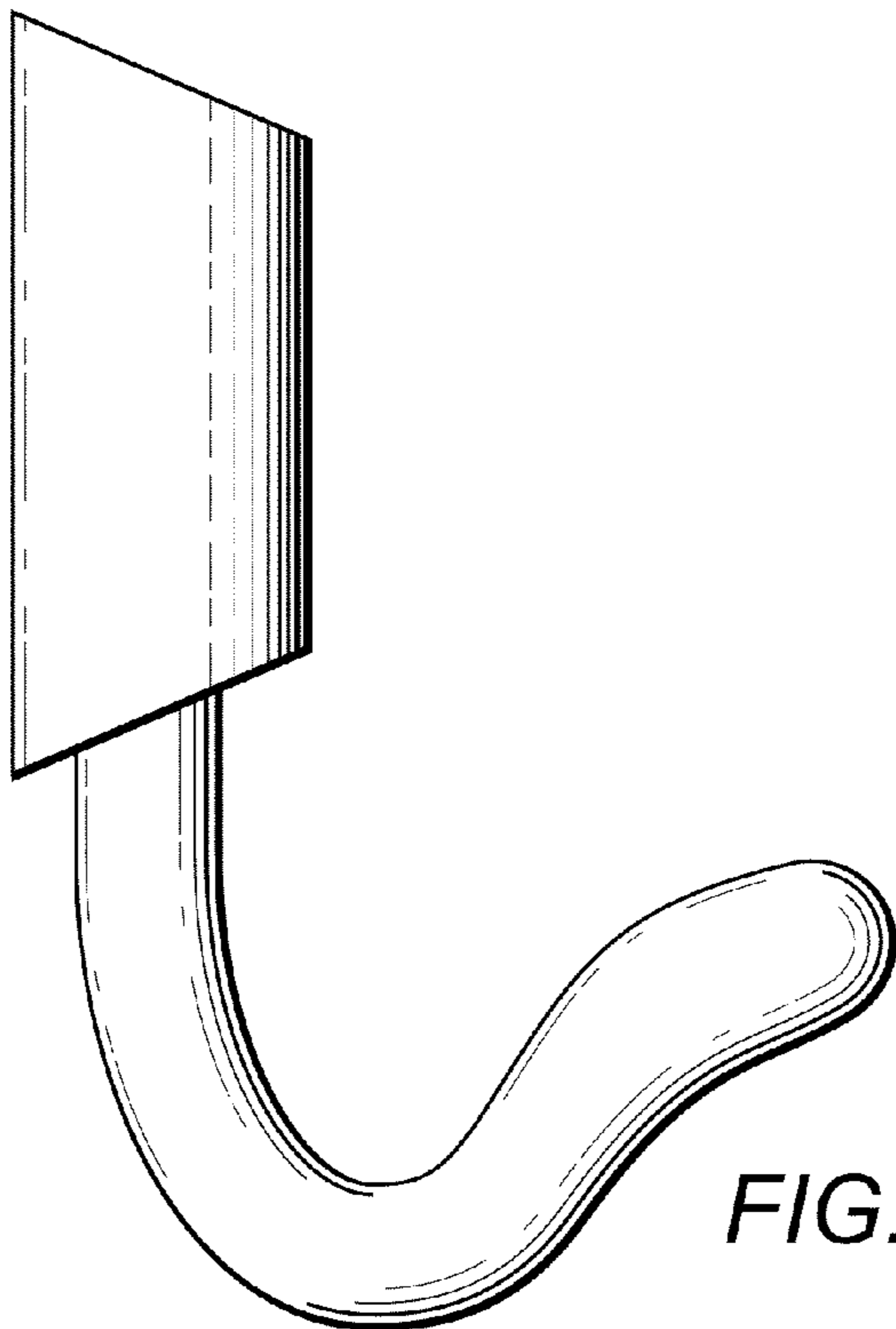

FIG. 6

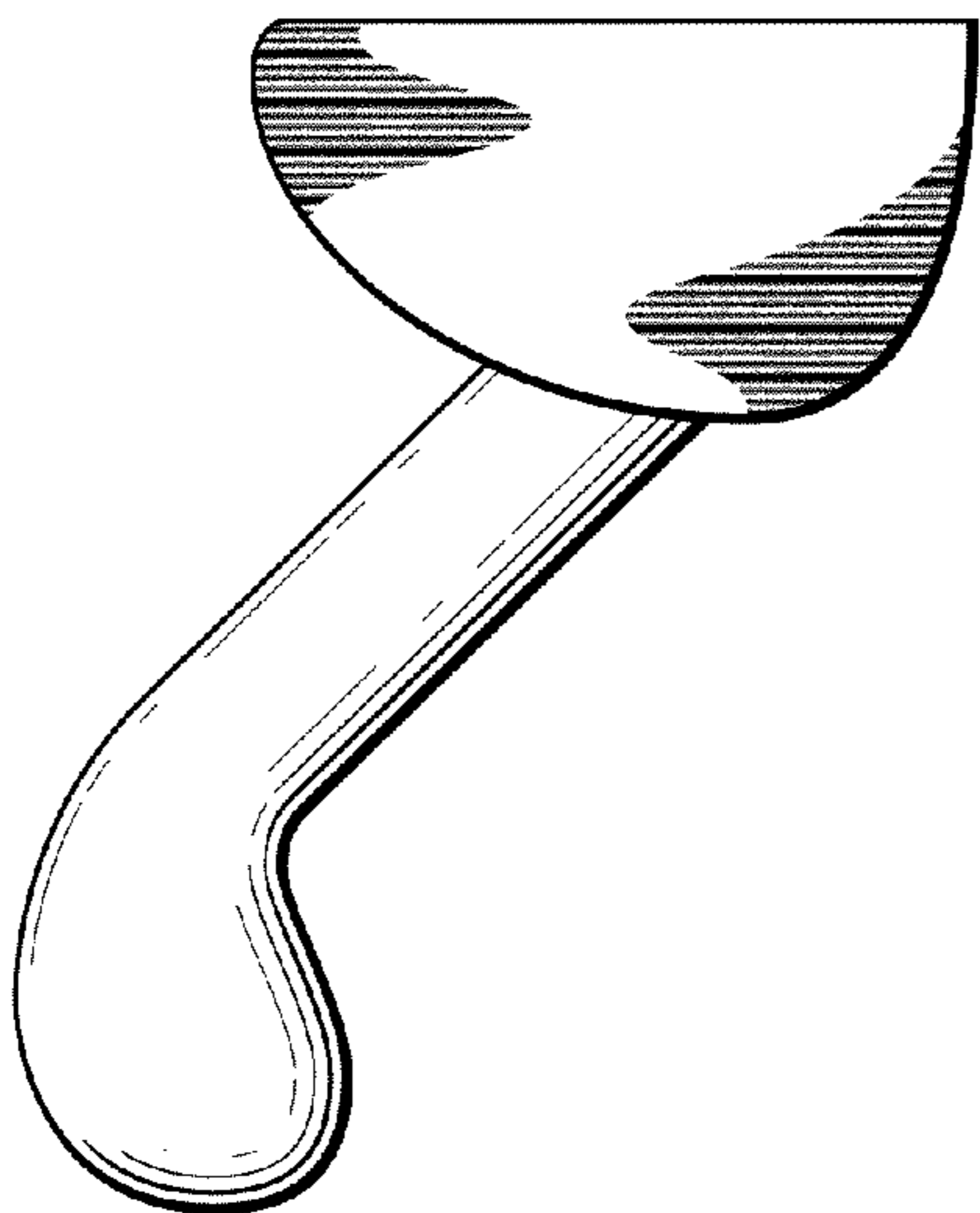

FIG. 7

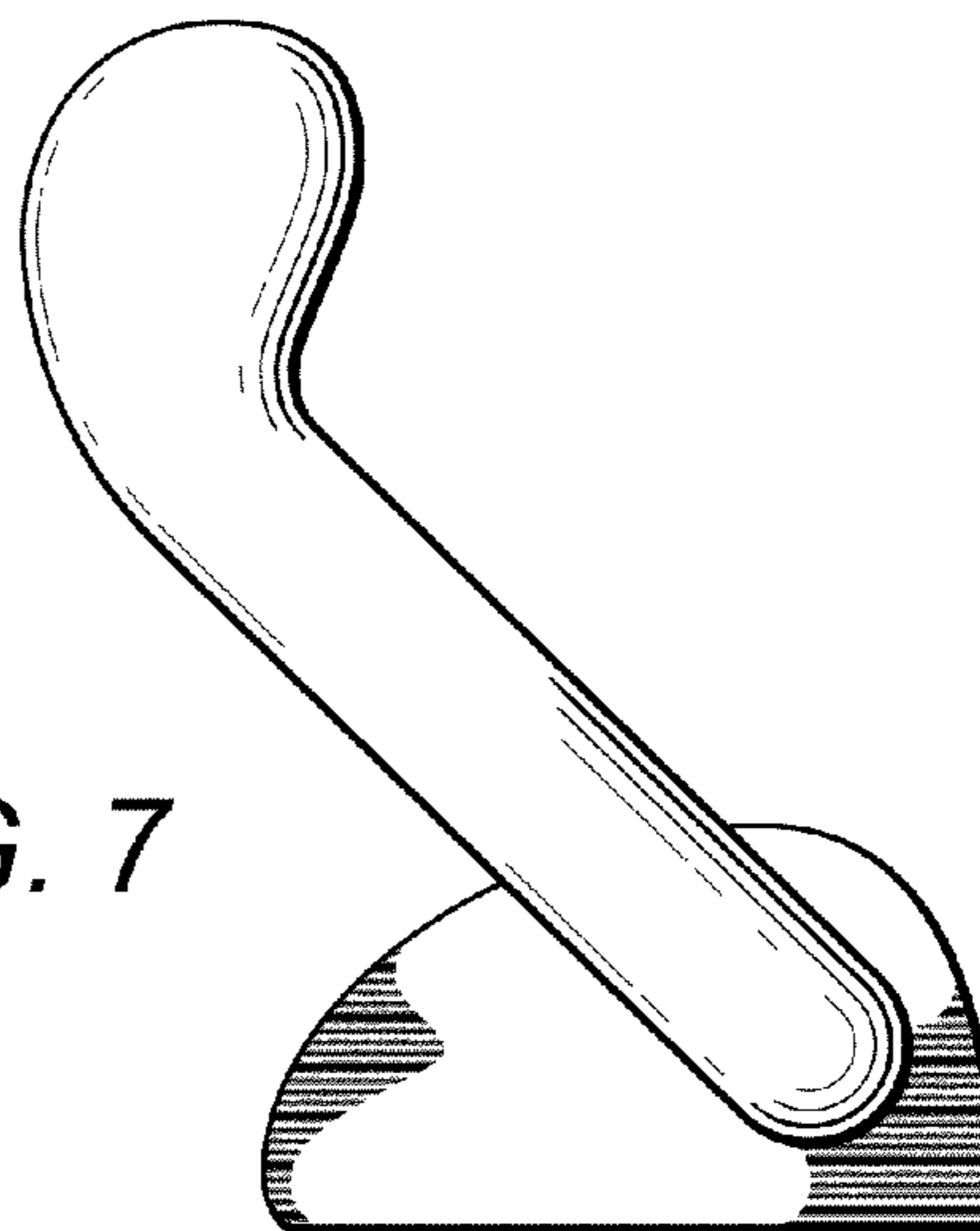

FIG. 8

