



US00D637785S

(12) **United States Design Patent**
Miller et al.

(10) **Patent No.:** **US D637,785 S**

(45) **Date of Patent:** **** May 10, 2011**

(54) **TANK FRAME**

(75) Inventors: **Keith A. Miller**, Schererville, IN (US);
Chad A. Cederberg, Lincoln, NE (US);
Ken Halvorsen, Lincoln, NE (US)

(73) Assignee: **Lincoln Composites, Inc.**, Lincoln, NE (US)

(**) Term: **14 Years**

(21) Appl. No.: **29/350,006**

(22) Filed: **Nov. 10, 2009**

(51) **LOC (9) Cl.** **12-05**

(52) **U.S. Cl.** **D34/28**

(58) **Field of Classification Search** D34/28,
D34/38; 220/1.5; 108/57.13, 55.1, 56.1;
248/346.02, 346.01, 346.04

See application file for complete search history.

(56) **References Cited**

U.S. PATENT DOCUMENTS

4,662,532	A *	5/1987	Anderson et al.	220/7
5,265,748	A *	11/1993	Furukawa	220/1.5
5,810,186	A *	9/1998	Lam	220/1.5
D402,037	S *	12/1998	Hofstad	D34/38
D533,978	S *	12/2006	Hawes	D34/38
D534,330	S *	12/2006	Hawes	D34/38
7,624,885	B2 *	12/2009	Pfau	220/1.5
D609,425	S *	2/2010	Svedberg	D34/38
2007/0000921	A1 *	1/2007	Butler et al.	220/1.5
2007/0210080	A1 *	9/2007	Hooper	220/1.5
2009/0159592	A1 *	6/2009	Vitalis et al.	220/1.5
2010/0074723	A1 *	3/2010	Lancon	414/800

OTHER PUBLICATIONS

Eight (8) illustrations (photos) of tank frames and tank trailers publicly known prior to Nov. 10, 2008 (5 pages).

* cited by examiner

Primary Examiner — Cynthia E Ramirez

(74) *Attorney, Agent, or Firm* — Westman, Champlin & Kelly

(57) **CLAIM**

The ornamental design for a tank frame, as shown and described.

DESCRIPTION

FIG. 1 is an isometric view of the tank frame;
 FIG. 2 is a side elevational view thereof, as taken from the back side in FIG. 1;
 FIG. 3 is a side elevational view thereof, as taken from the front side in FIG. 1;
 FIG. 4 is an end elevational view thereof, as taken from the left end in FIG. 1;
 FIG. 5 is an end elevational view thereof, as taken from the right end in FIG. 1;
 FIG. 6 is a top view thereof, as taken from the top of FIG. 2;
 and,
 FIG. 7 is a bottom plan view thereof, as taken from the bottom of FIG. 2.

The portions of the tank frame shown in broken lines in the figures form no part of the claimed design.

1 Claim, 4 Drawing Sheets

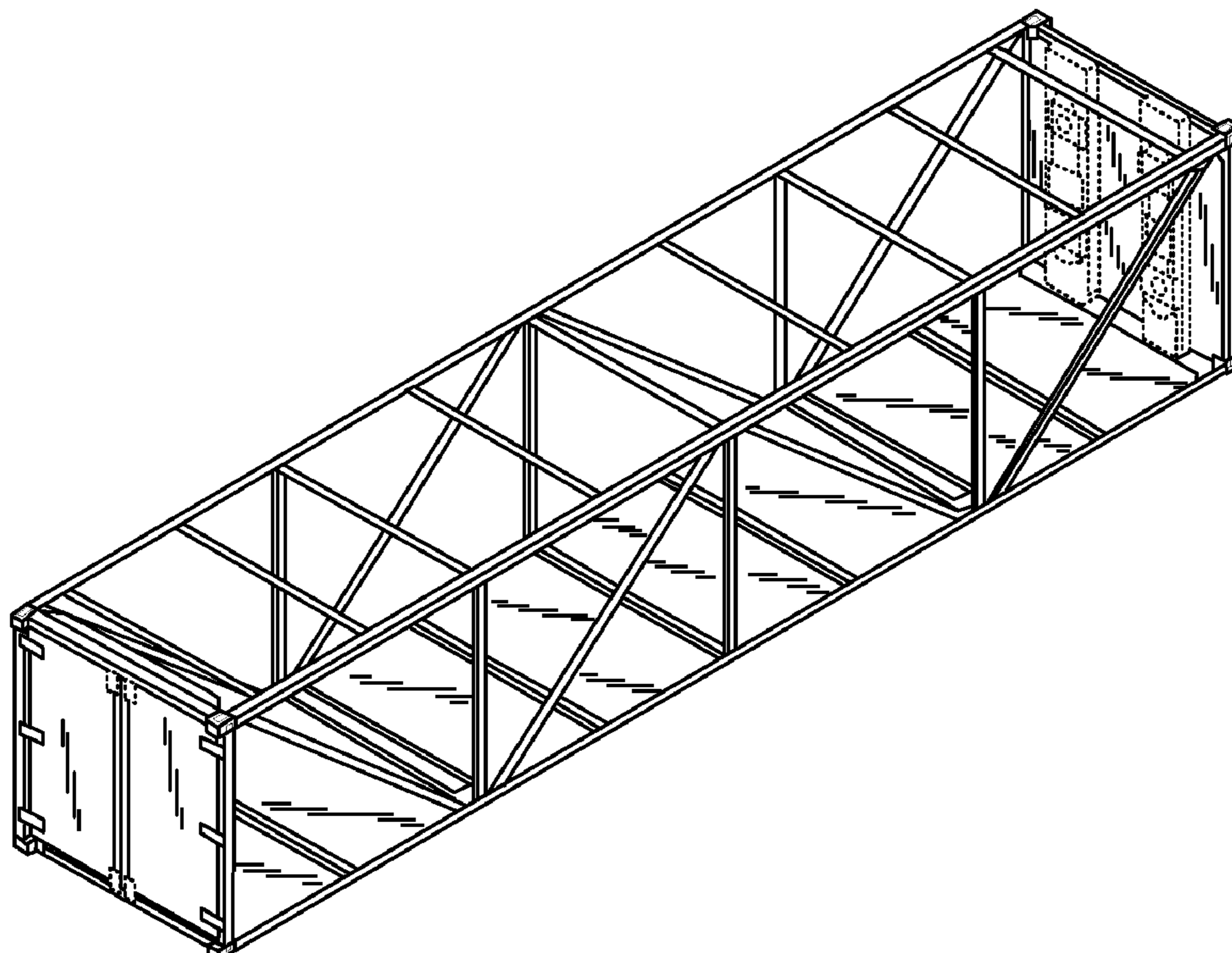

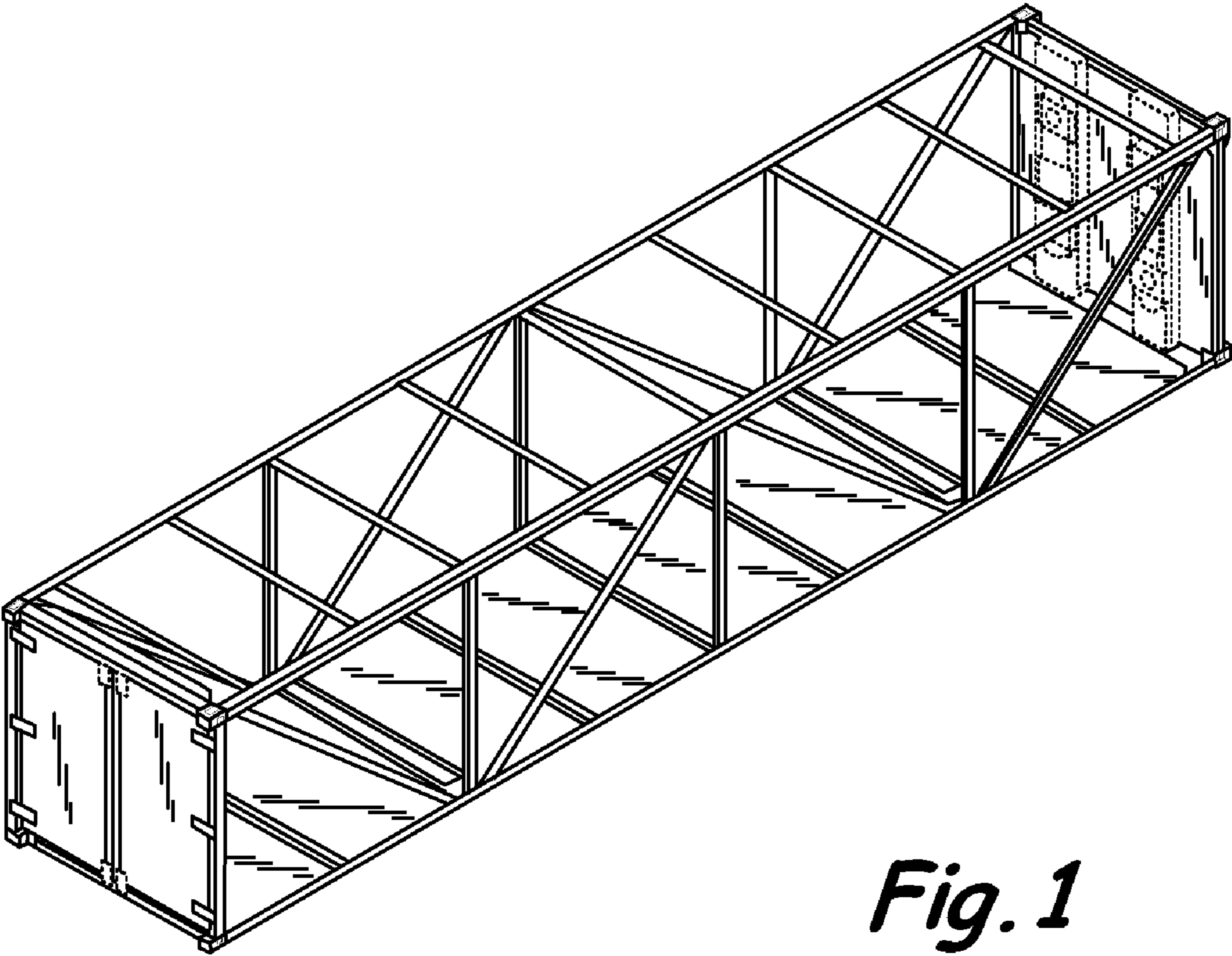

Fig. 1

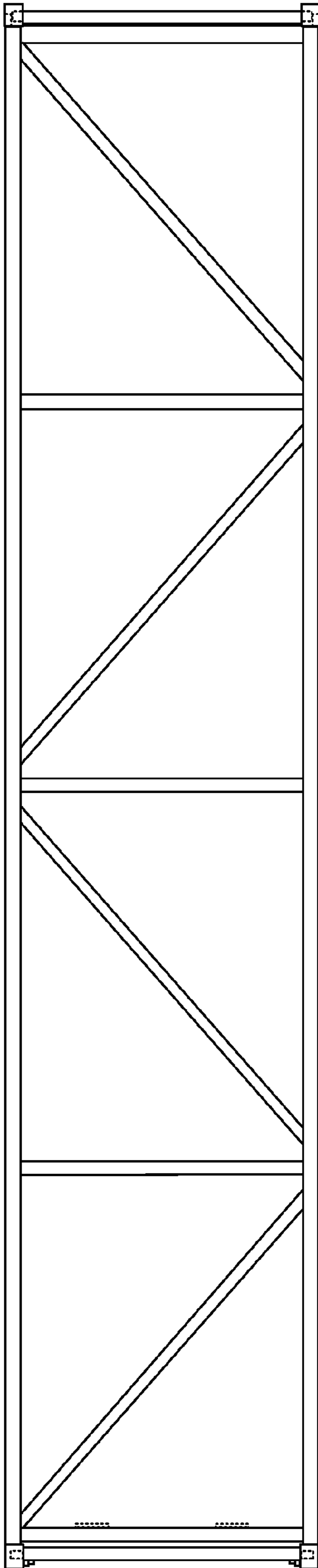

Fig. 2

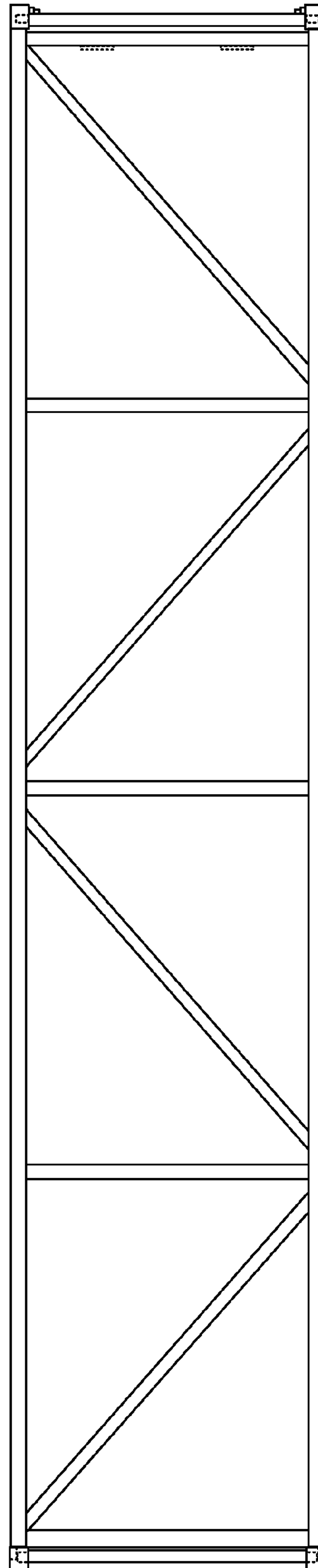

Fig. 3

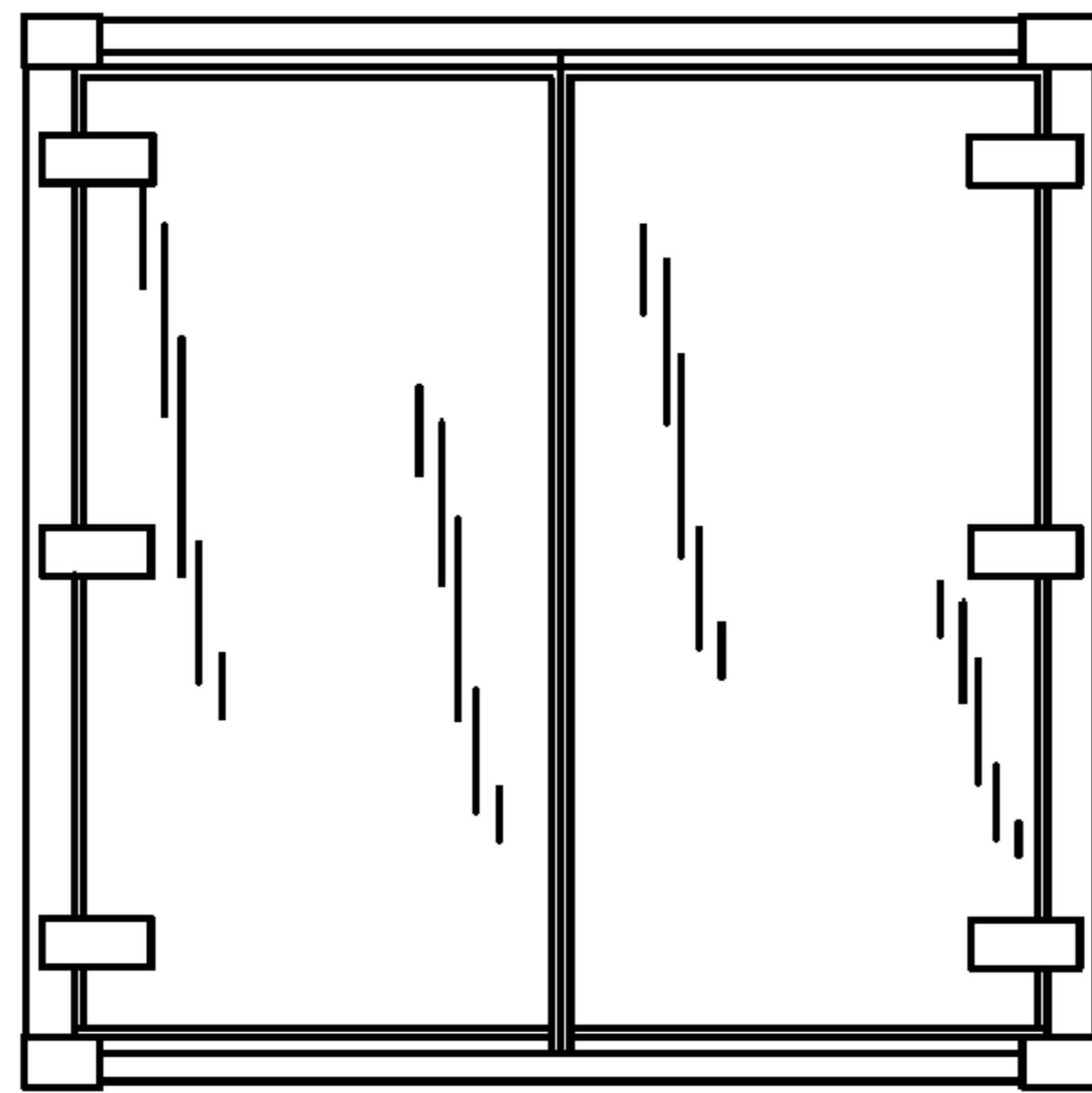

Fig. 4

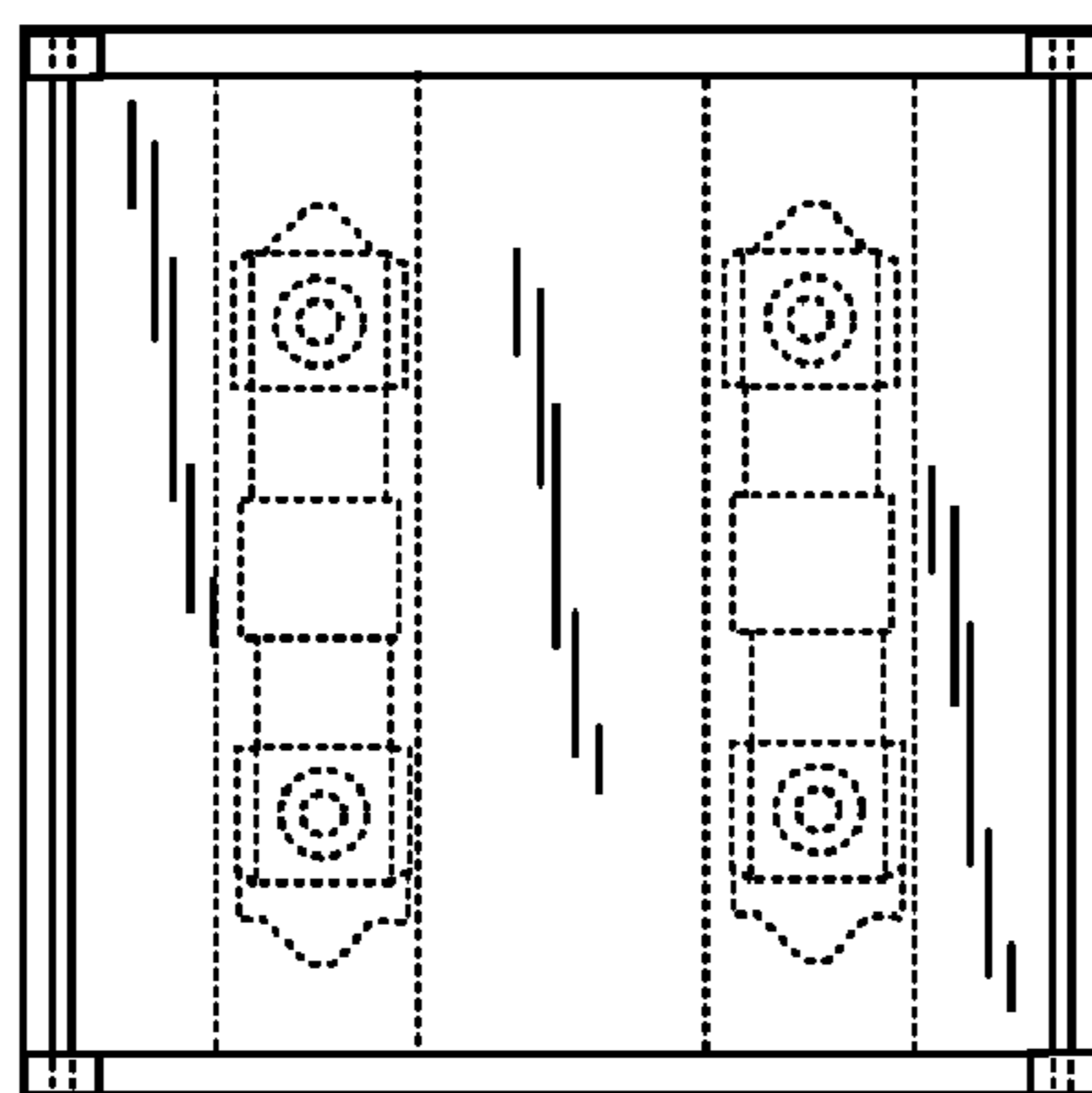

Fig. 5

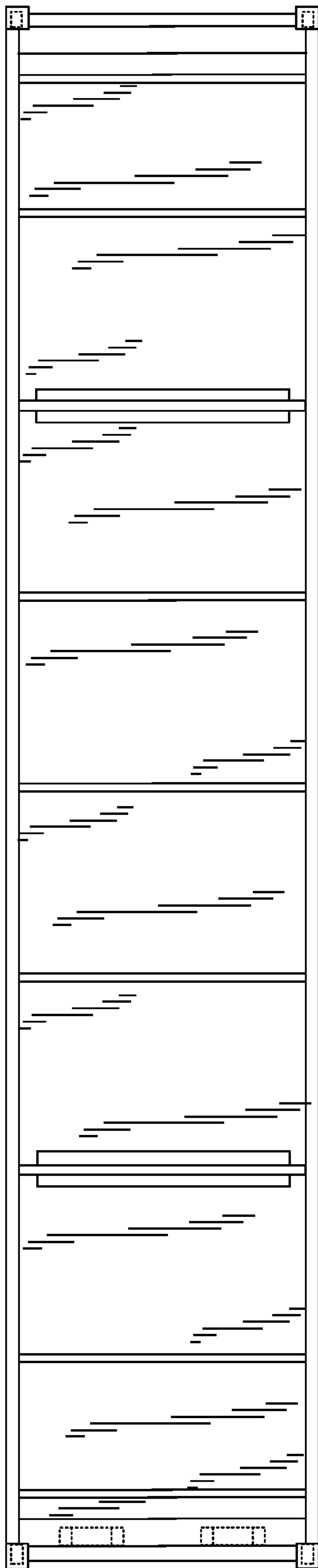

Fig. 6

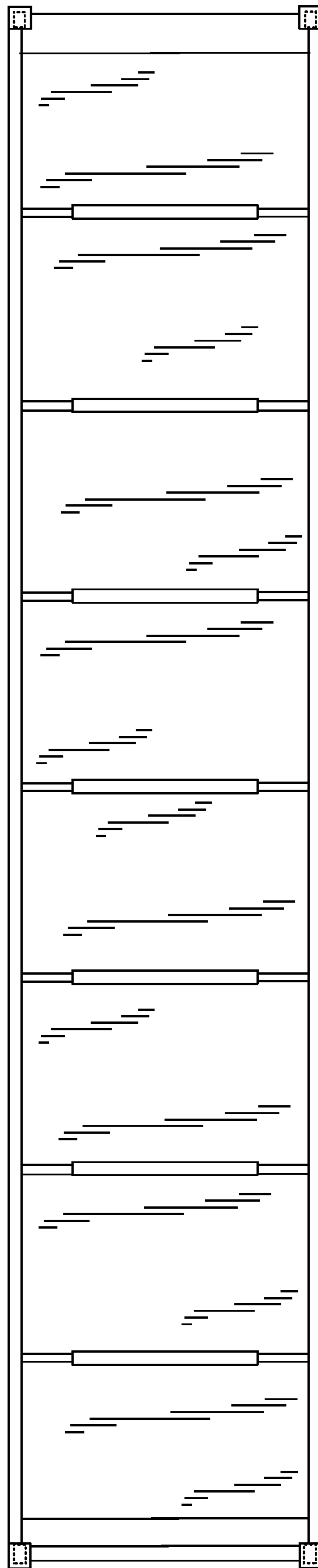

Fig. 7