



US00D637720S

(12) **United States Design Patent**  
**Folwaczny et al.**

(10) **Patent No.:** **US D637,720 S**

(45) **Date of Patent:** **\*\* May 10, 2011**

(54) **MEDICAL INSTRUMENT**

(75) Inventors: **Matthias Folwaczny**, Starnberg (DE);  
**Tobias Schwoy**, Tuttlingen-Mohringen  
(DE)

(73) Assignee: **Karl Storz GmbH & Co. KG** (DE)

(\*\*) Term: **14 Years**

(21) Appl. No.: **29/353,824**

(22) Filed: **Jan. 14, 2010**

(30) **Foreign Application Priority Data**

Jul. 14, 2009 (EM) ..... 001581810-0015

(51) **LOC (9) Cl.** ..... **24-02**

(52) **U.S. Cl.** ..... **D24/144**

(58) **Field of Classification Search** ..... D24/144,  
D24/133, 138, 147, 140, 152, 155-156, 176-177,  
D24/186, 137; 433/27, 29, 31, 72, 82, 114,  
433/141, 133, 102; 600/101, 104, 129, 223,  
600/226, 241, 245

See application file for complete search history.

(56) **References Cited**

**U.S. PATENT DOCUMENTS**

|           |     |         |                 |       |         |
|-----------|-----|---------|-----------------|-------|---------|
| 3,590,232 | A * | 6/1971  | Sadowski        | ..... | 433/29  |
| 3,683,503 | A * | 8/1972  | Klein           | ..... | 433/29  |
| 3,943,914 | A * | 3/1976  | Grenfell et al. | ..... | 433/72  |
| D271,419  | S * | 11/1983 | Hoff            | ..... | D24/144 |
| D288,359  | S * | 2/1987  | Hoff            | ..... | D24/144 |
| 4,995,403 | A * | 2/1991  | Beckman et al.  | ..... | 433/72  |
| 5,230,621 | A * | 7/1993  | Jacoby          | ..... | 433/29  |
| 5,328,365 | A * | 7/1994  | Jacoby          | ..... | 433/29  |
| 5,484,434 | A * | 1/1996  | Cartmell et al. | ..... | D24/144 |
| D377,524  | S * | 1/1997  | Lipp            | ..... | D24/144 |

|              |      |         |                |       |         |
|--------------|------|---------|----------------|-------|---------|
| 5,868,563    | A *  | 2/1999  | Davis et al.   | ..... | 433/29  |
| 5,882,194    | A *  | 3/1999  | Davis et al.   | ..... | 433/29  |
| 5,908,295    | A *  | 6/1999  | Kawata         | ..... | 433/29  |
| 5,997,296    | A *  | 12/1999 | Schuldink      | ..... | 433/72  |
| 6,179,611    | B1 * | 1/2001  | Everett et al. | ..... | 433/29  |
| D437,937     | S *  | 2/2001  | Bottjer        | ..... | D24/144 |
| 6,464,498    | B1 * | 10/2002 | Pond           | ..... | 433/81  |
| 6,607,384    | B1 * | 8/2003  | Nakanishi      | ..... | 433/29  |
| 2007/0027443 | A1 * | 2/2007  | Rose et al.    | ..... | 433/29  |
| 2008/0108010 | A1 * | 5/2008  | Wang           | ..... | 433/29  |
| 2008/0182222 | A1 * | 7/2008  | Li             | ..... | 433/29  |
| 2009/0061383 | A1 * | 3/2009  | Kang           | ..... | 433/72  |
| 2009/0112258 | A1 * | 4/2009  | Kreidler       | ..... | 606/222 |

\* cited by examiner

*Primary Examiner* — Ian Simmons

*Assistant Examiner* — Wan Laymon

(74) *Attorney, Agent, or Firm* — St. Onge Steward Johnston  
& Reens LLC

(57) **CLAIM**

The ornamental design for a medical instrument, as shown and described.

**DESCRIPTION**

FIG. 1 is a left side perspective view of a medical instrument in accordance with the new design;  
FIG. 2 is a left side elevation view thereof, the right side elevation view being a mirror image thereof;  
FIG. 3 is a top plan view thereof;  
FIG. 4 is a bottom plan view thereof;  
FIG. 5 is a rear elevation view thereof; and,  
FIG. 6 is a front elevation view thereof.  
The broken lines showing portions of the medical instrument are included for the purpose of illustrating environmental structure and form no part of the claimed design.

**1 Claim, 3 Drawing Sheets**

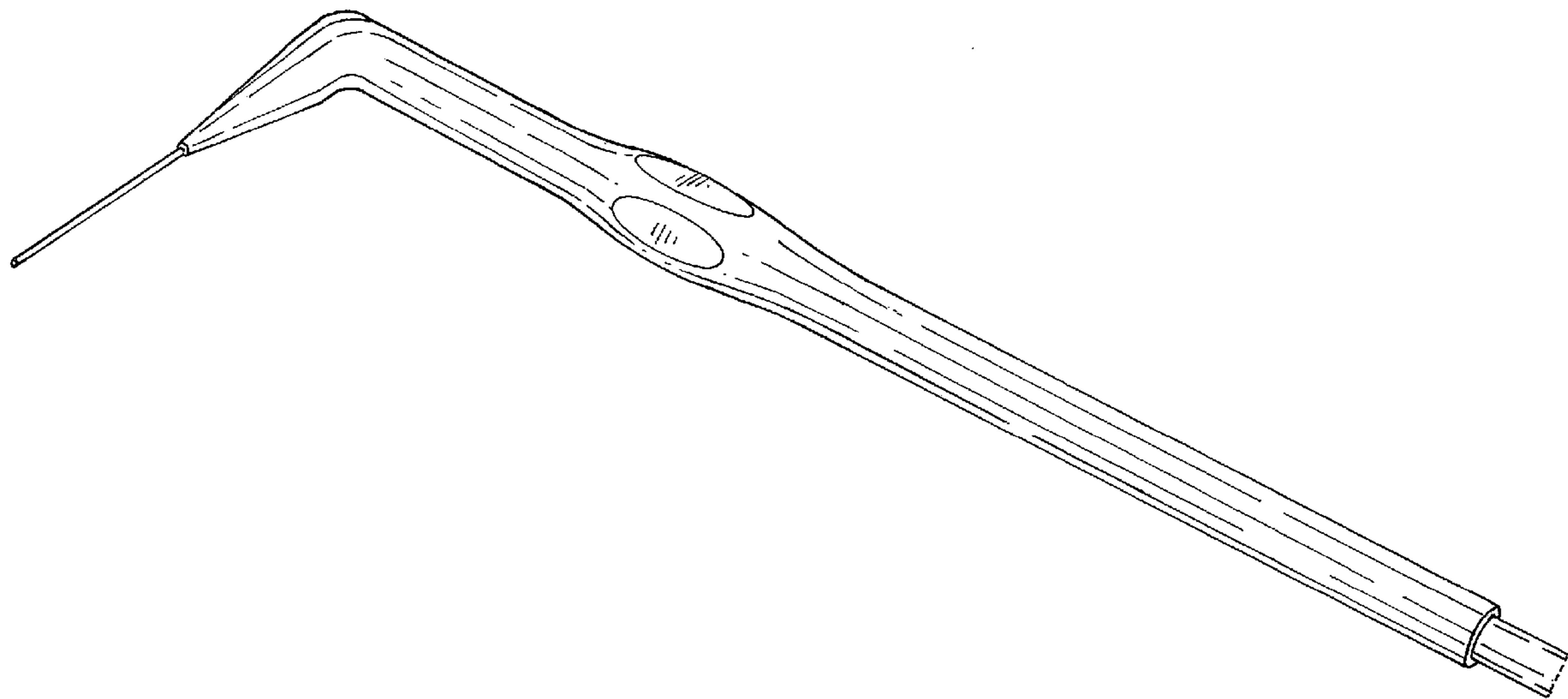

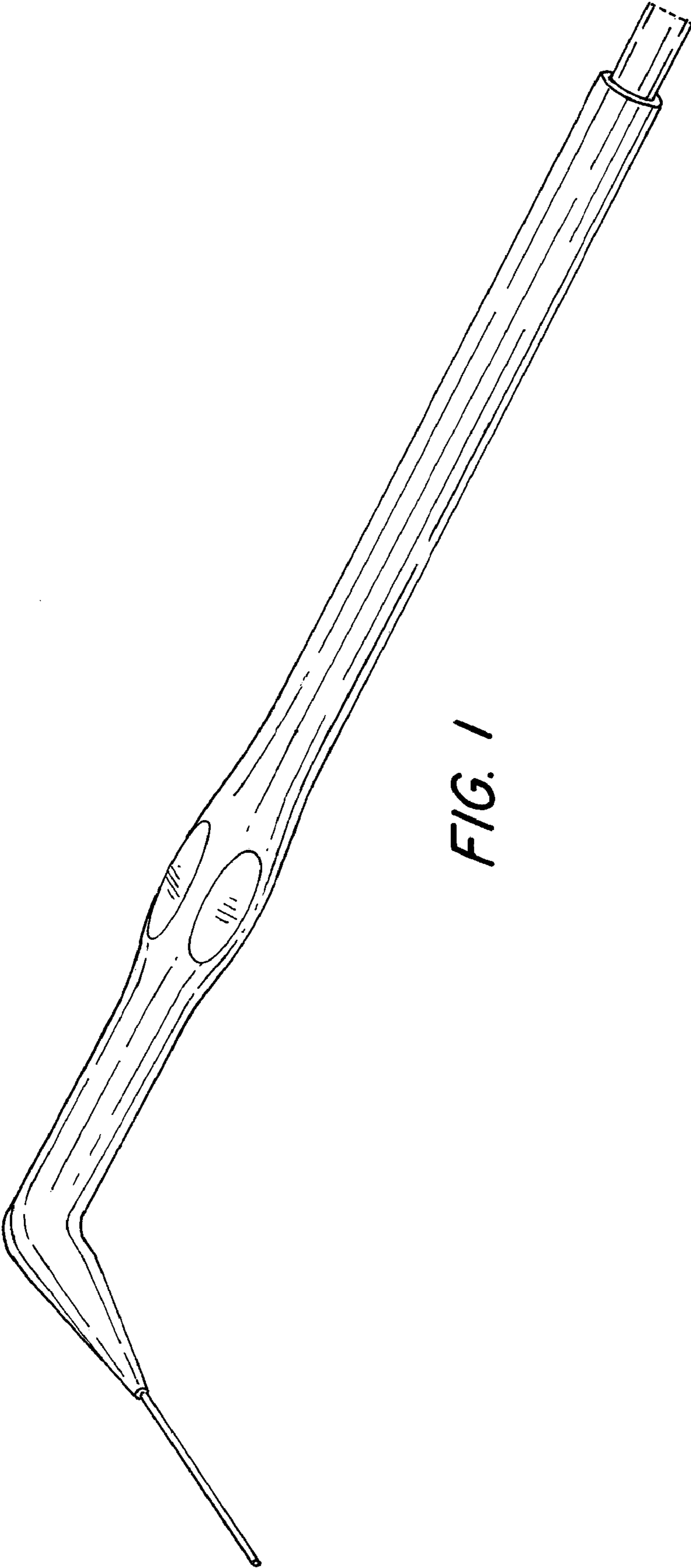
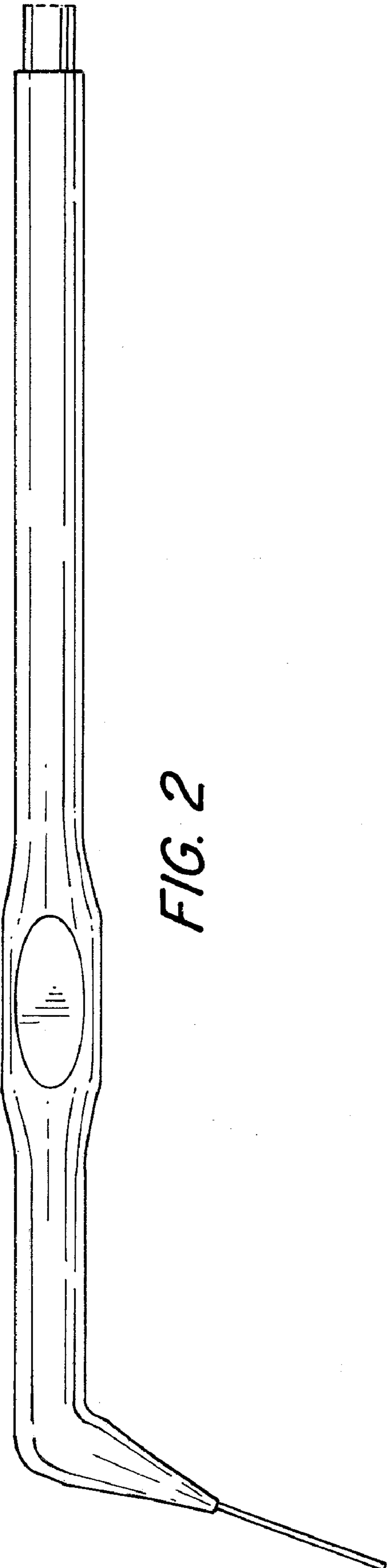
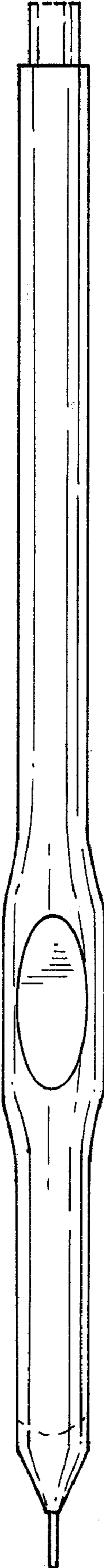

FIG. 1



*FIG. 2*



*FIG. 3*

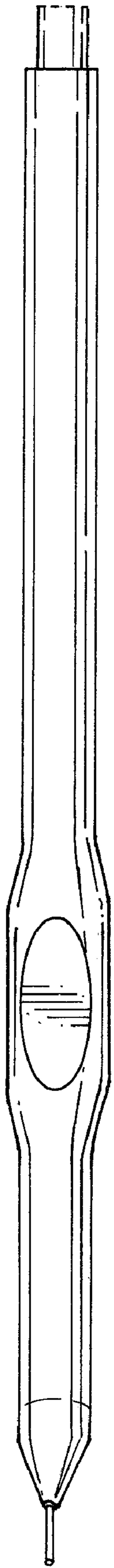

*FIG. 4*

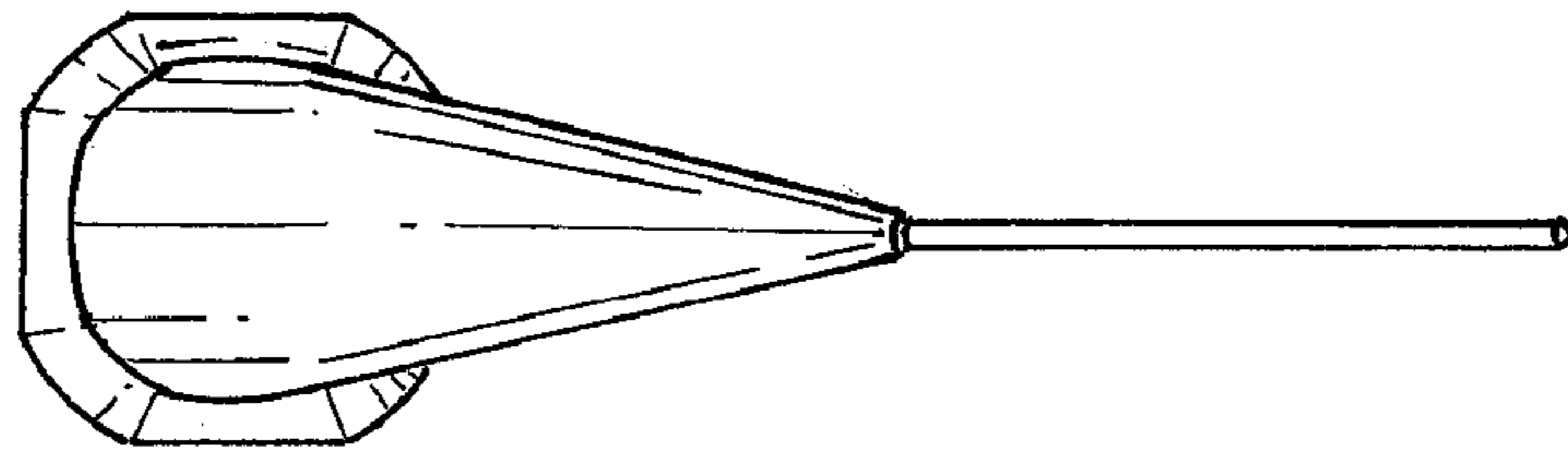

*FIG. 6*

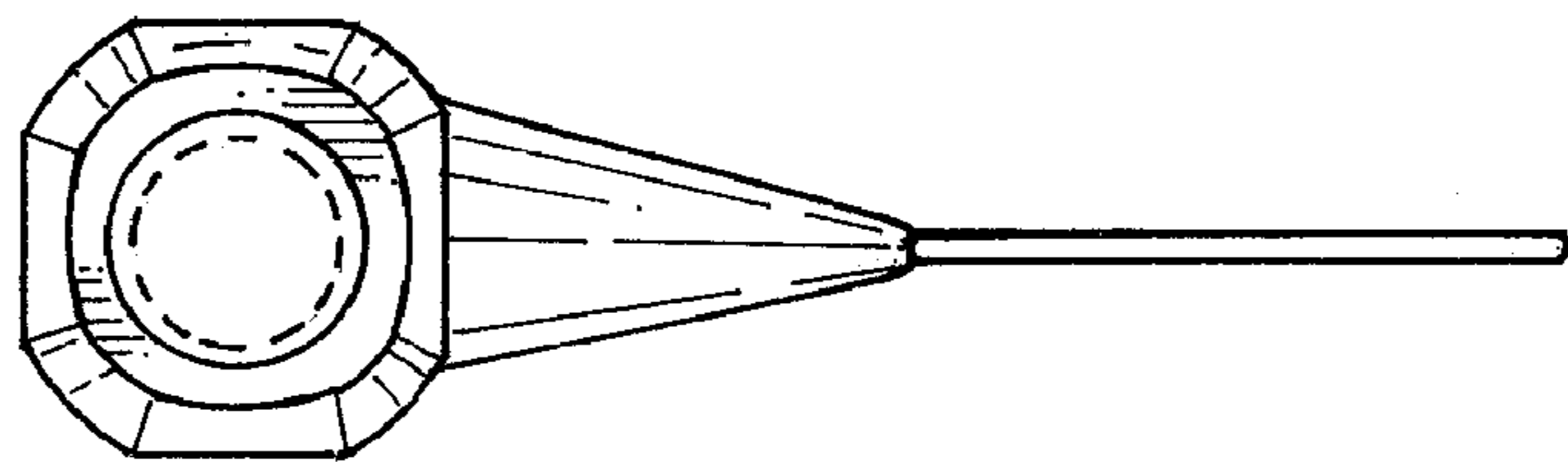

*FIG. 5*