



US00D637682S

(12) **United States Design Patent**
Bentley et al.

(10) **Patent No.:** **US D637,682 S**

(45) **Date of Patent:** **** May 10, 2011**

(54) **FIREARM MAGAZINE WITH PLACARD**

(75) Inventors: **James K. Bentley**, Meridian, ID (US);
Ryan T. Cowgill, Fruitland, ID (US)

(73) Assignee: **Krow Innovation, LLC**, Paso Robles,
CA (US)

(**) Term: **14 Years**

(21) Appl. No.: **29/346,733**

(22) Filed: **Nov. 5, 2009**

(51) **LOC (9) Cl.** **22-01**

(52) **U.S. Cl.** **D22/108**

(58) **Field of Classification Search** D22/100,
D22/101, 103, 104, 108, 199; D21/572,
D21/573; 42/51, 71.01, 75.01, 75.02, 90,
42/94, 134, 136, 139, 125, 72, 111; 362/110;
33/241, 277; 313/105 R; 89/40.06, 41.19,
89/37.04, 33.04, 191.01, 200-204; 124/67,
124/66, 74; D20/22, 27, 99

See application file for complete search history.

(56) **References Cited**

U.S. PATENT DOCUMENTS

D297,854 S * 9/1988 Vyprachticky D22/108
D366,065 S * 1/1996 Lockard D20/22
2010/0162606 A1 * 7/2010 Laney et al. 42/50

* cited by examiner

Primary Examiner — T. Chase Nelson

Assistant Examiner — Michael A Pratt

(74) *Attorney, Agent, or Firm* — Zarian Midgley & Johnson
PLLC

(57) **CLAIM**

The ornamental design for a firearm magazine with placard,
as shown and described.

DESCRIPTION

FIG. 1 is a perspective view of the firearm magazine with
placard of the present invention;

FIG. 2 is a top view of the firearm magazine with placard of
FIG. 1;

FIG. 3 is a bottom view of the firearm magazine with placard
of FIG. 1;

FIG. 4 is a front view of the firearm magazine with placard of
FIG. 1;

FIG. 5 is a back view of the firearm magazine with placard of
FIG. 1;

FIG. 6 is a left side view of the firearm magazine with placard
of FIG. 1;

FIG. 7 is a right side view of the firearm magazine with
placard of FIG. 1; and,

FIG. 8 is a perspective view of the firearm magazine with
placard of FIG. 1 inserted into a firearm.

The broken lines upon the firearm magazine with placard
depict portions of the design and/or environmental structure
that form no part of the claimed design. The broken lines
associated with arrows in FIG. 1 show the order of assembly
of the separated components of the design in this view, and
also form no part of the claimed design. In FIG. 8, the broken
line depiction of a firearm is for purposes of showing the
environment of use, and these broken lines also form no part
of the claimed design.

1 Claim, 4 Drawing Sheets

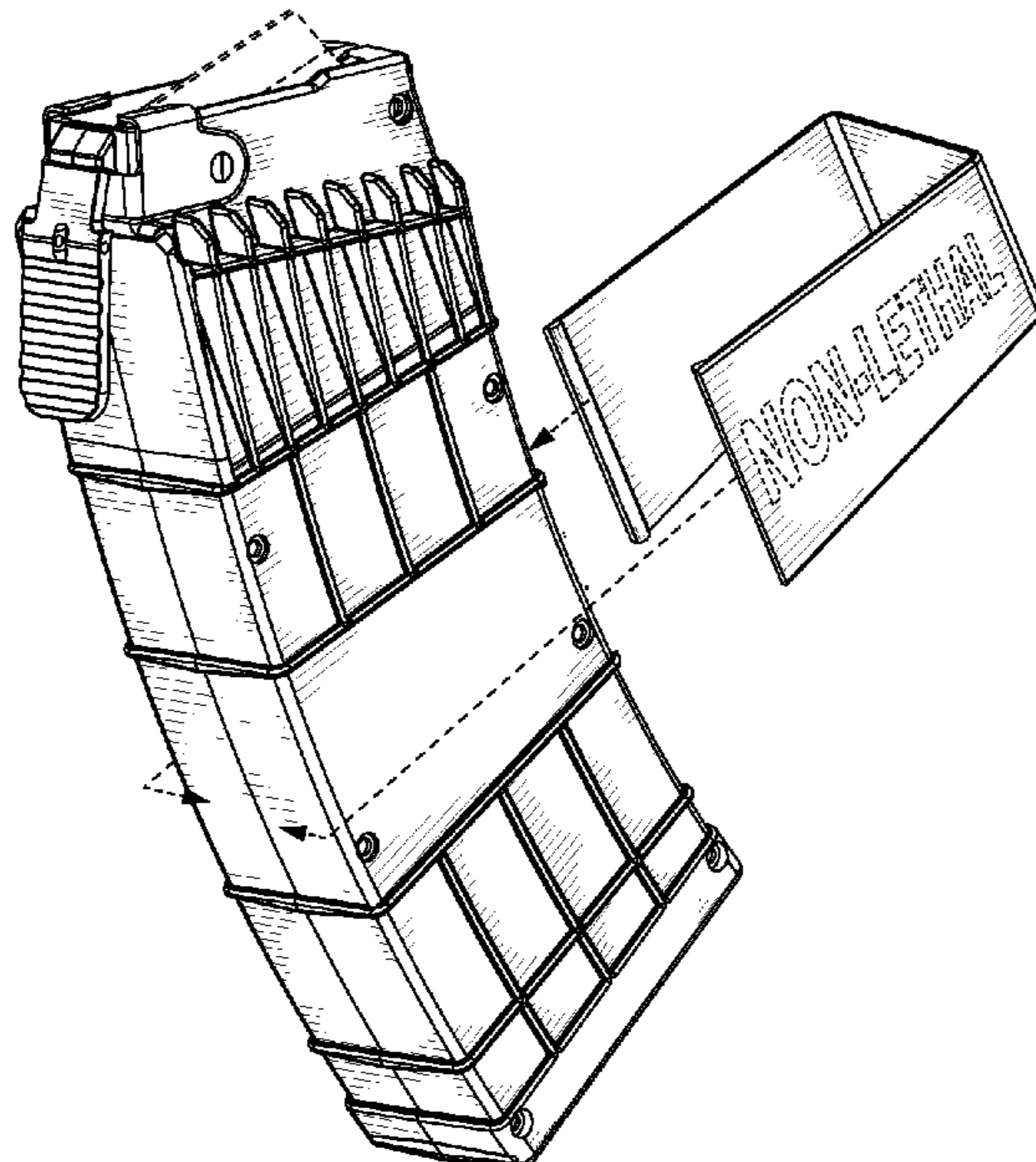

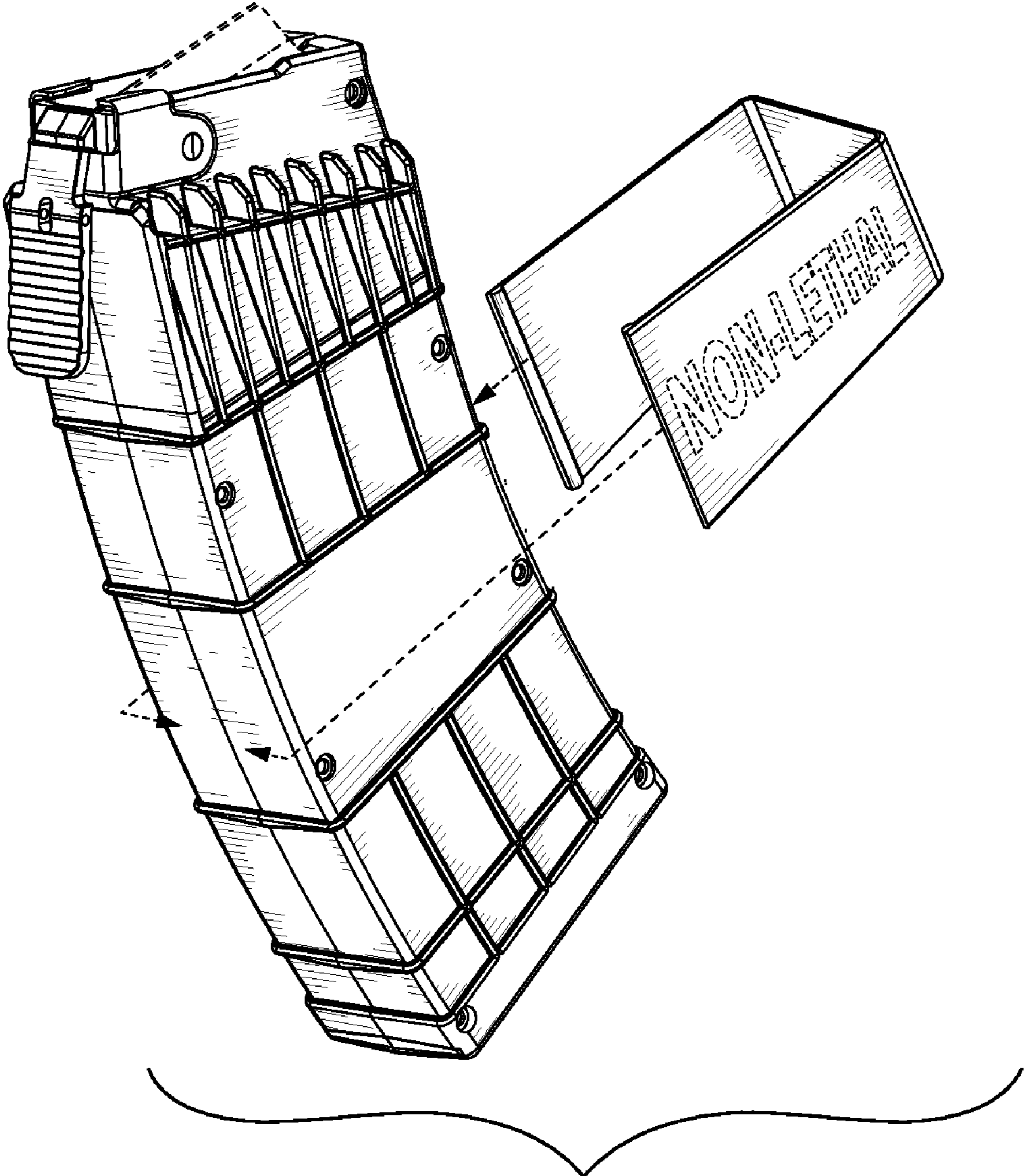

FIG. 1

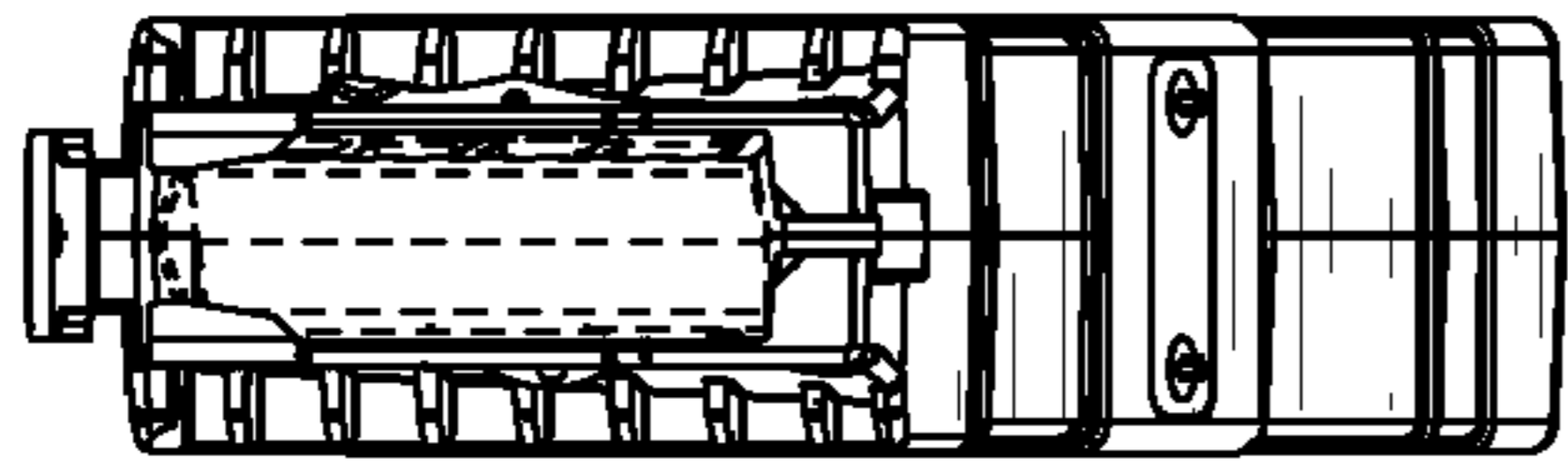

FIG. 2

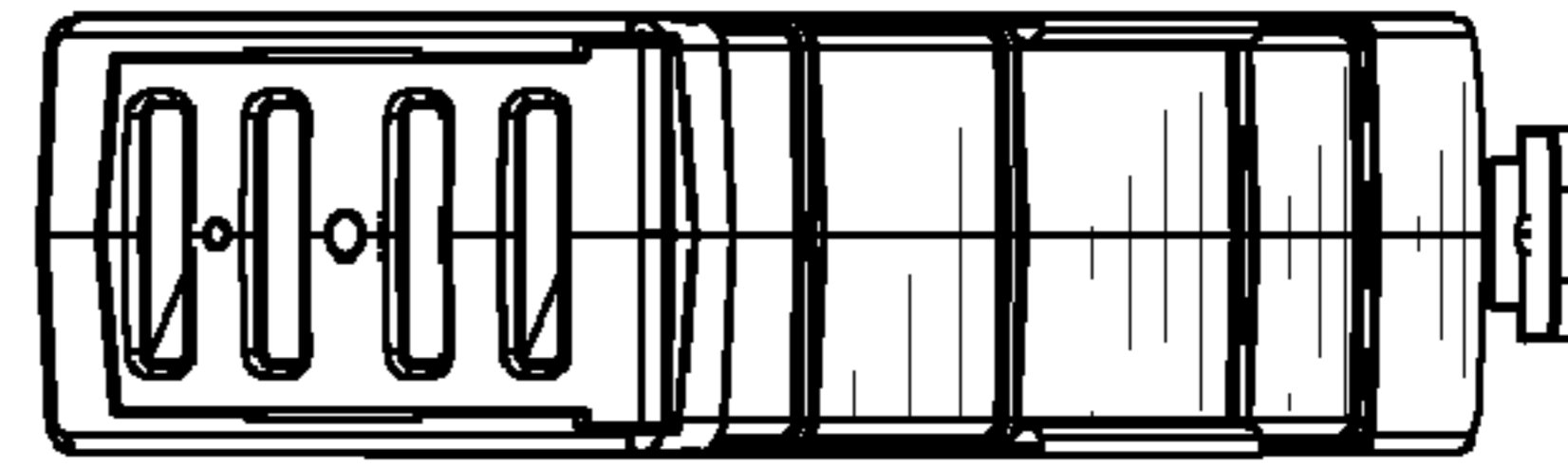

FIG. 3

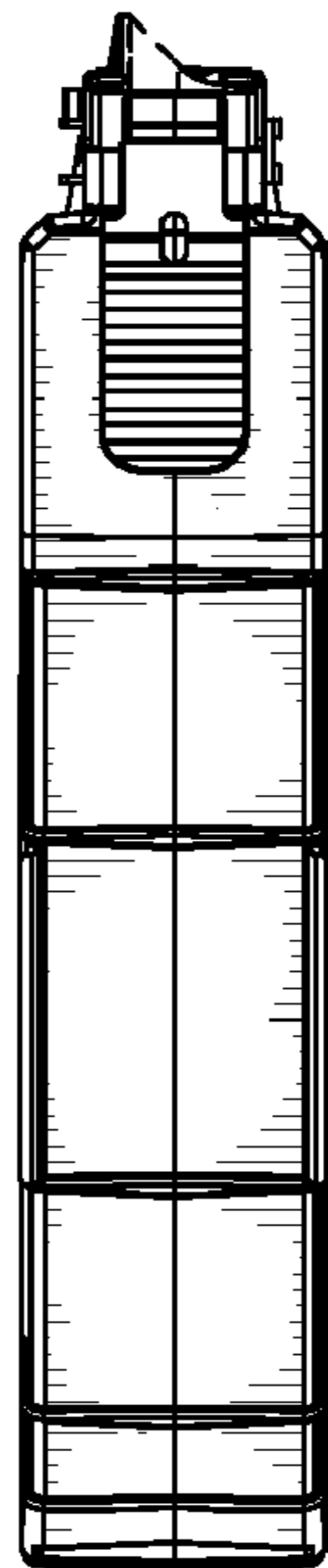

FIG. 4

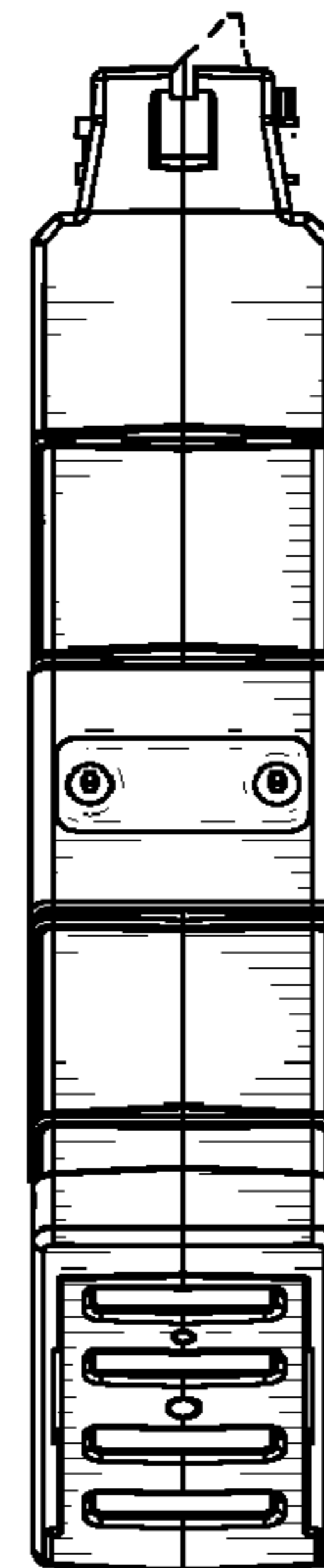

FIG. 5

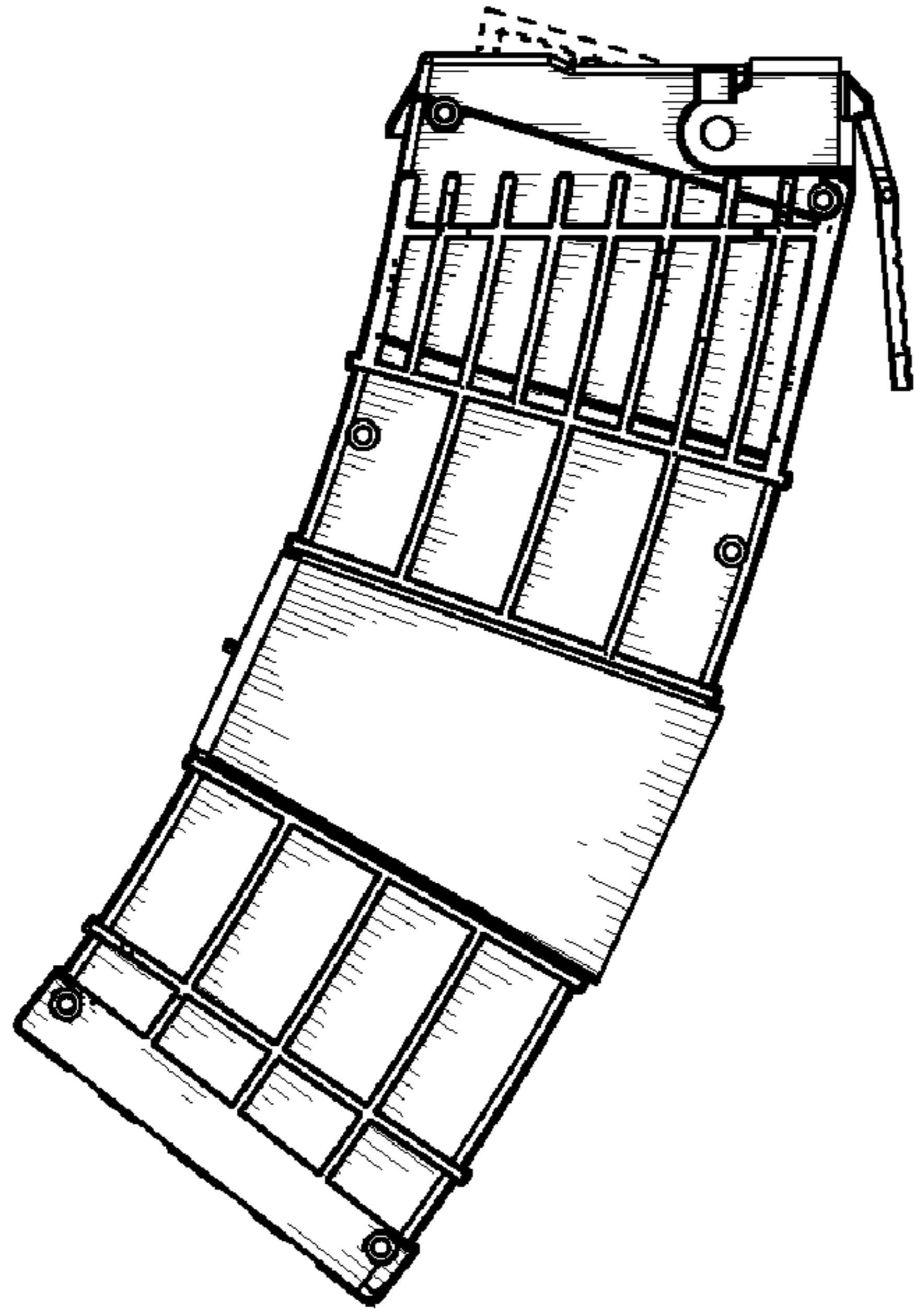

FIG. 6

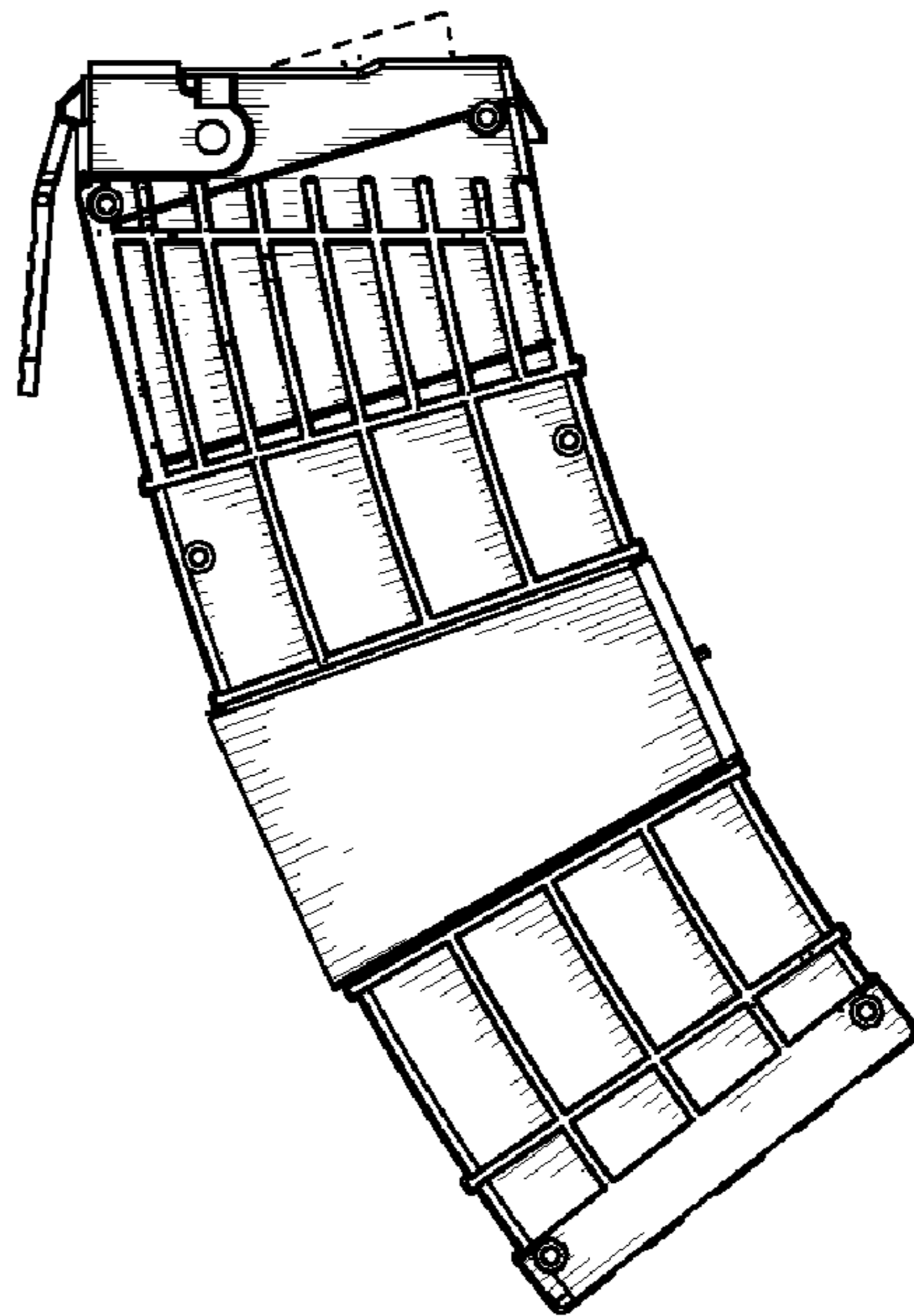

FIG. 7

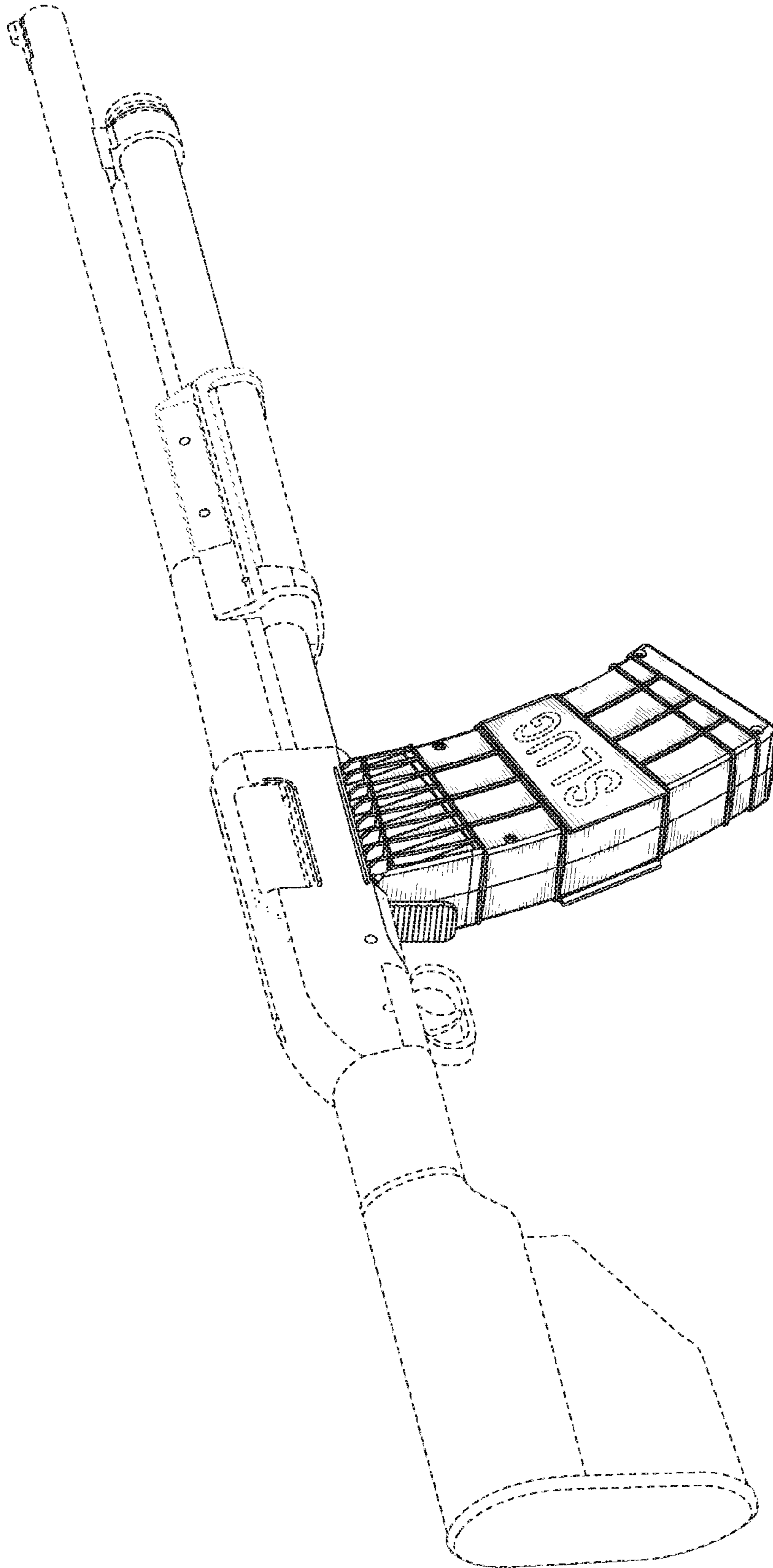

FIG. 8