

US00D637502S

(12) **United States Design Patent**
Begin et al.

(10) **Patent No.:** **US D637,502 S**

(45) **Date of Patent:** **** May 10, 2011**

(54) **DOOR TEMPLATE**

(75) Inventors: **Jason E. Begin**, Roswell, GA (US);
Craig Davidson, Cornelius, NC (US)

(73) Assignee: **Newell Operating Company**, Atlanta,
GA (US)

(**) Term: **14 Years**

(21) Appl. No.: **29/361,494**

(22) Filed: **May 12, 2010**

(51) **LOC (9) Cl.** **10-04**

(52) **U.S. Cl.** **D10/64**

(58) **Field of Classification Search** D10/64,
D10/65; 33/562-566, 669, 679.1; 493/51,
493/56, 84, 86, 88, 90, 93, 114, 115, 186,
493/187, 210, 217, 218, 221, 223, 227, 228,
493/231, 240; 112/475.01

See application file for complete search history.

(56) **References Cited**

U.S. PATENT DOCUMENTS

D348,015 S * 6/1994 Durst et al. D10/64
D393,217 S 4/1998 Brickman
D393,218 S 4/1998 Brickman

OTHER PUBLICATIONS

Co-pending U.S. Appl. No. 29/361,493, filed May 12, 2010.

* cited by examiner

Primary Examiner — Antoine D Davis

(74) *Attorney, Agent, or Firm* — Dennis J. Williamson;
Moore & Van Allen, PLLC

(57) **CLAIM**

We claim the ornamental design for a door template, as shown
and described.

DESCRIPTION

FIG. 1 is a left side perspective view showing an embodiment
of our new design for a door template;

FIG. 2 is a front view showing our new design shown in FIG.
1;

FIG. 3 is a right side view showing our new design shown in
FIG. 1;

FIG. 4 is a left side view showing our new design shown in
FIG. 1;

FIG. 5 is a bottom view showing our new design shown in
FIG. 1;

FIG. 6 is a top view showing our new design shown in FIG. 1;

FIG. 7 is a back view showing our new design shown in FIG.
1; and,

FIG. 8 is a right side perspective view showing our new design
shown in FIG. 1.

The broken line showing of structural features is included for
the purpose of illustrating non-claimed subject matter and
forms no part of the claimed design.

1 Claim, 6 Drawing Sheets

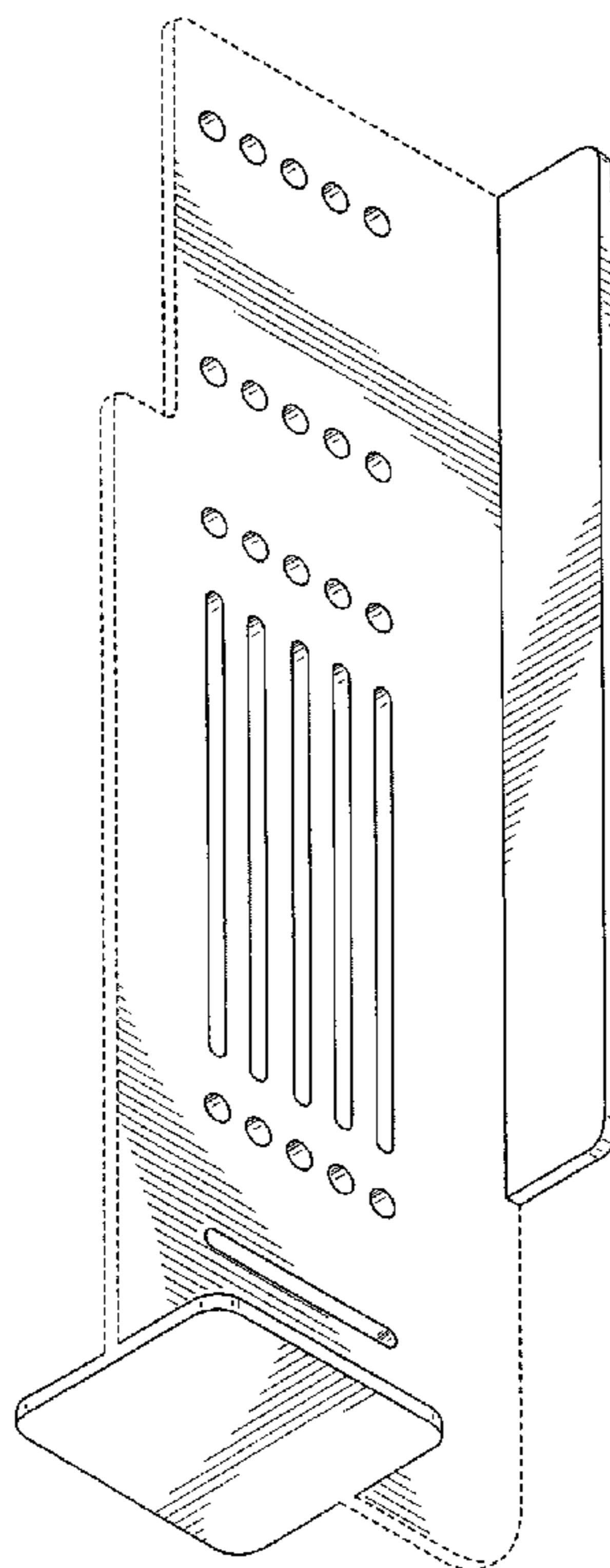

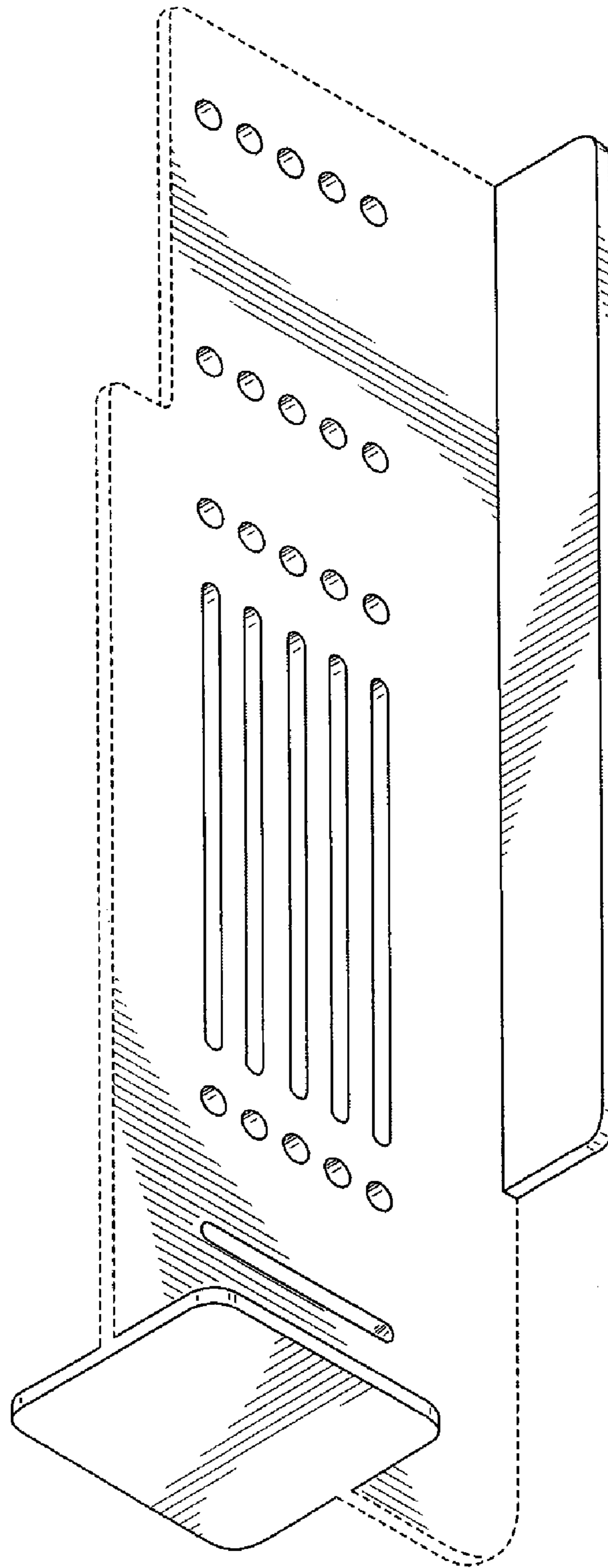

FIG. 1

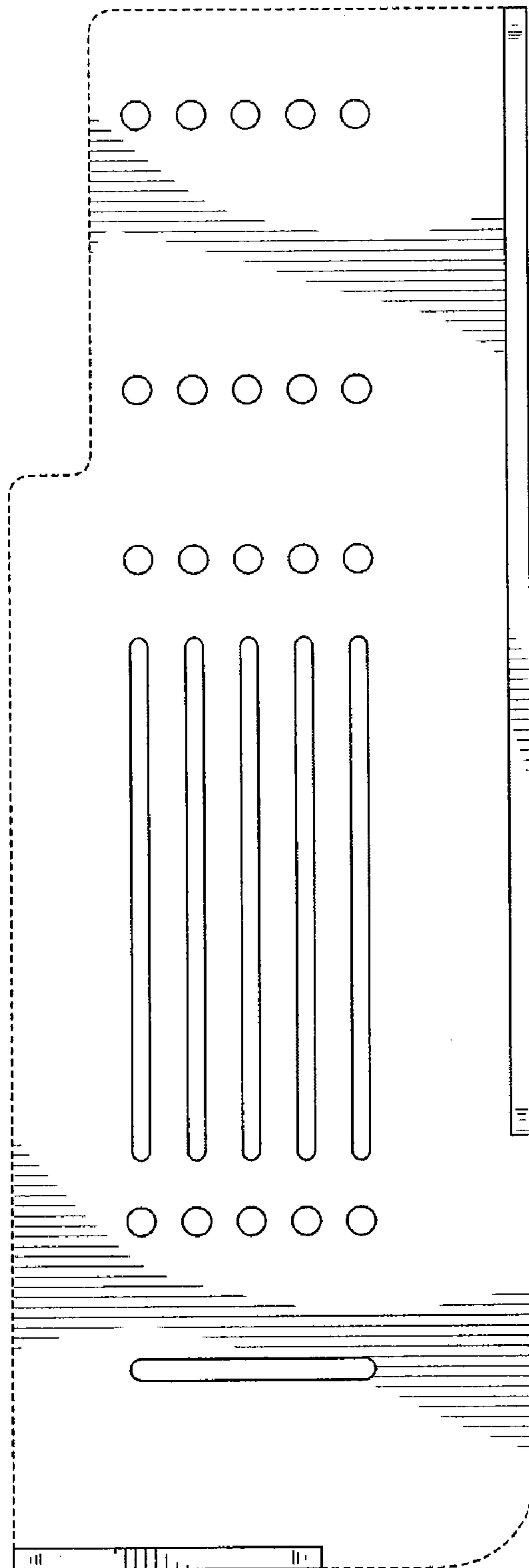

FIG. 2

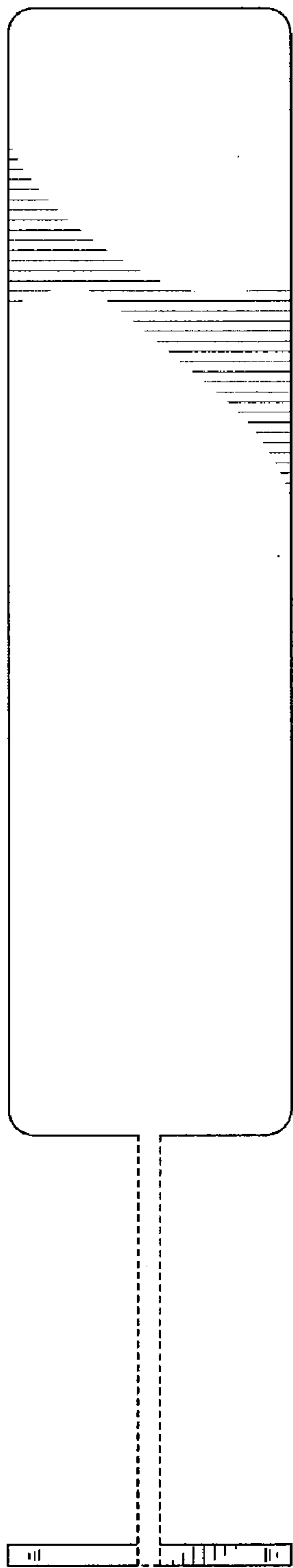

FIG. 3

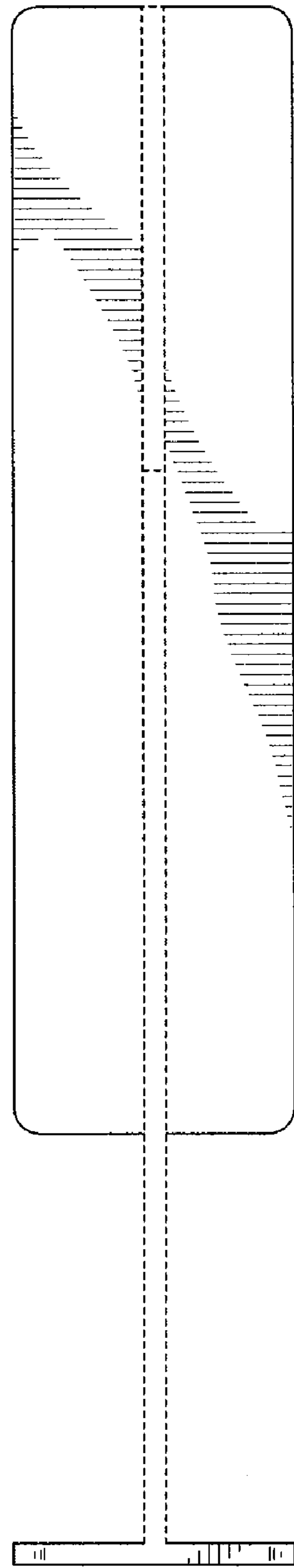

FIG. 4

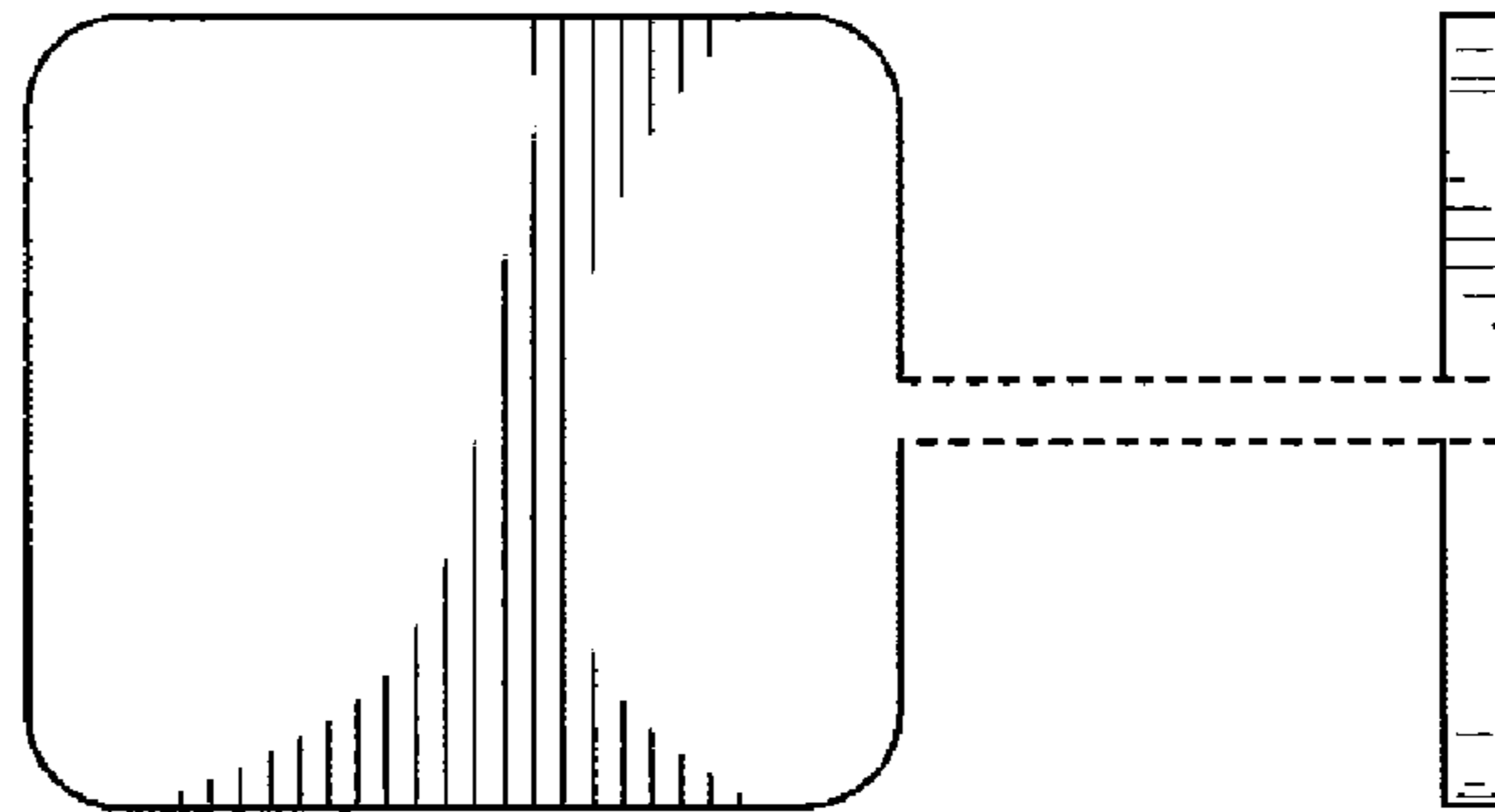

FIG. 5

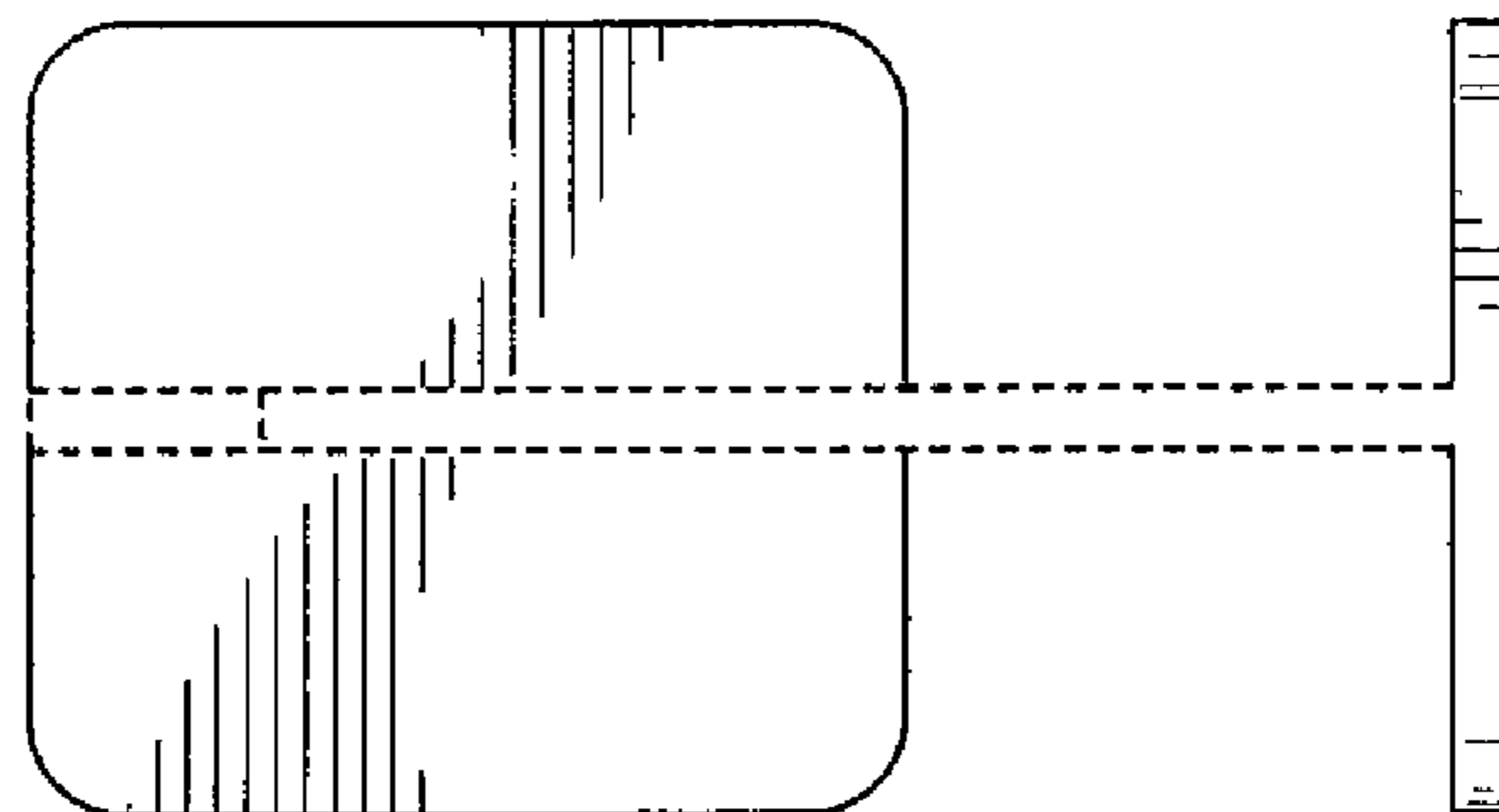

FIG. 6

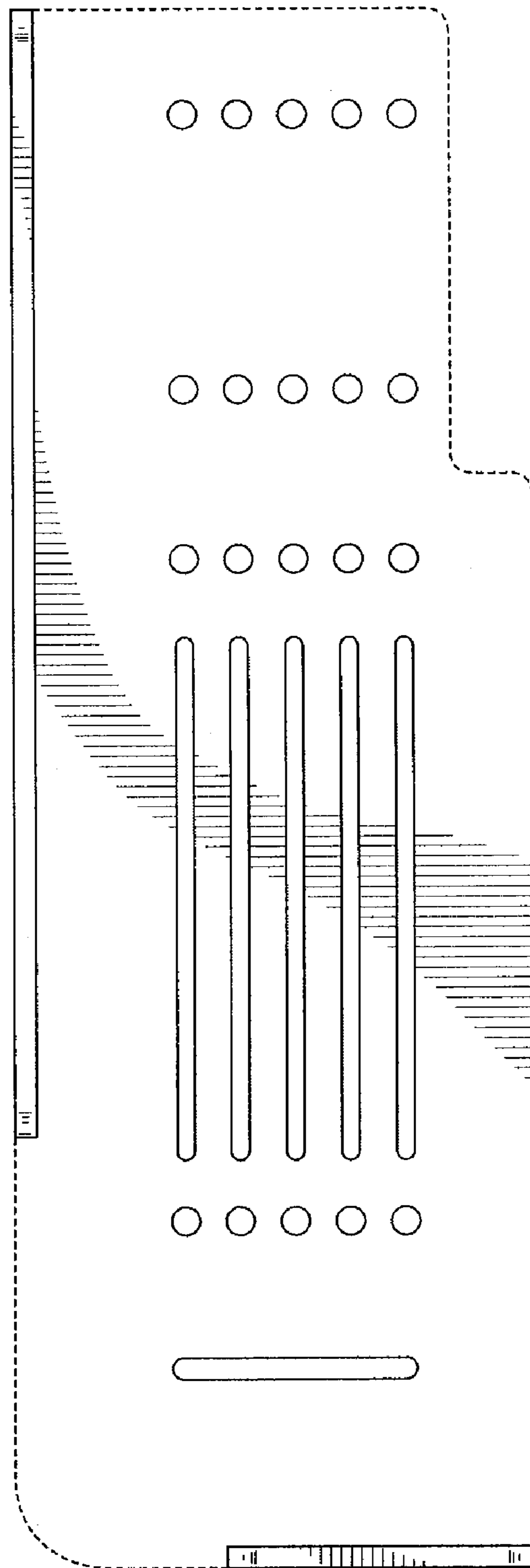

FIG. 7

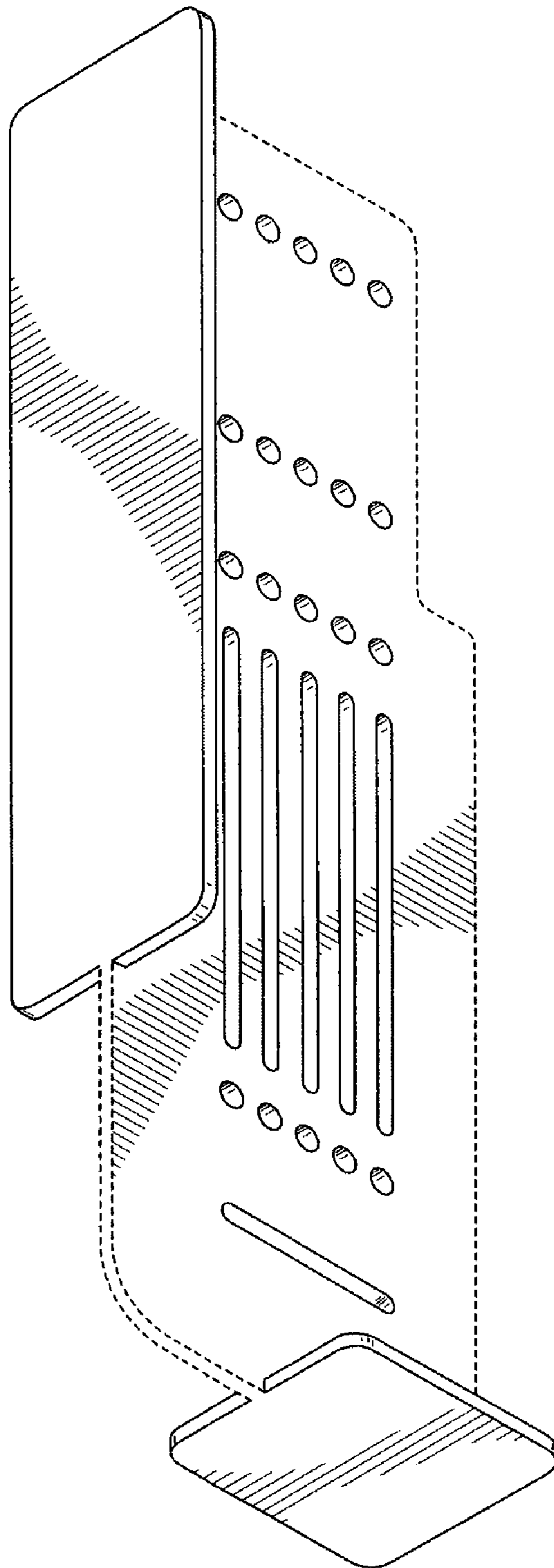

FIG. 8