



US00D637466S

(12) **United States Design Patent**
Singleton et al.

(10) **Patent No.:** **US D637,466 S**

(45) **Date of Patent:** **** May 10, 2011**

(54) **CAP PIERCER**

(75) Inventors: **Ian Singleton**, Darwen (GB); **David Taylor**, Chorley (GB)

(73) Assignee: **Amazon Bioguard Limited**, Lancashire (GB)

(**) Term: **14 Years**

(21) Appl. No.: **29/366,118**

(22) Filed: **Jul. 20, 2010**

(30) **Foreign Application Priority Data**

Feb. 24, 2010 (GB) 4014593

(51) **LOC (9) Cl.** **07-99**

(52) **U.S. Cl.** **D8/41**

(58) **Field of Classification Search** D7/665;
D8/14, 16-20, 33-43, 88, 89, 105; 7/113,
7/151-156; 30/400-410, 416-430, 433,
30/434, 443, 450; 81/3.07, 3.09, 3.2, 3.27,
81/3.29, 3.31, 3.35, 3.37, 3.4, 3.45, 3.48,
81/3.49, 3.55

See application file for complete search history.

(56) **References Cited**

U.S. PATENT DOCUMENTS

990,561 A * 4/1911 Kandlbinder 7/113
4,678,380 A * 7/1987 Zahuranec et al. 408/211

4,726,264 A *	2/1988	Bost	81/3.4
D301,540 S *	6/1989	Zahuranec et al.	D8/14
D319,957 S *	9/1991	Bergmeister	D8/42
D388,660 S *	1/1998	Grundl	D8/34
D404,623 S *	1/1999	Burrell	D8/33
D474,084 S *	5/2003	Yip	D8/40
6,779,213 B2 *	8/2004	Yip	7/155
D519,795 S *	5/2006	Hayward	D8/14
D553,926 S *	10/2007	Velez	D8/40
2004/0112177 A1 *	6/2004	Yip	81/3.48

* cited by examiner

Primary Examiner — Garth Rademaker

(74) *Attorney, Agent, or Firm* — The Webb Law Firm

(57) **CLAIM**

The ornamental design for a cap piercer, as shown and described.

DESCRIPTION

FIG. 1 is a top view of a cap piercer in accordance with our new design;
FIG. 2 is a bottom view thereof;
FIG. 3 is a front view thereof, the back, left side, and right side views being identical thereto;
FIG. 4 is a top perspective view thereof;
FIG. 5 is a bottom perspective view thereof;
FIG. 6 is a front perspective view thereof; and,
FIG. 7 is another front perspective view thereof, shown at a reduced scale.

1 Claim, 7 Drawing Sheets

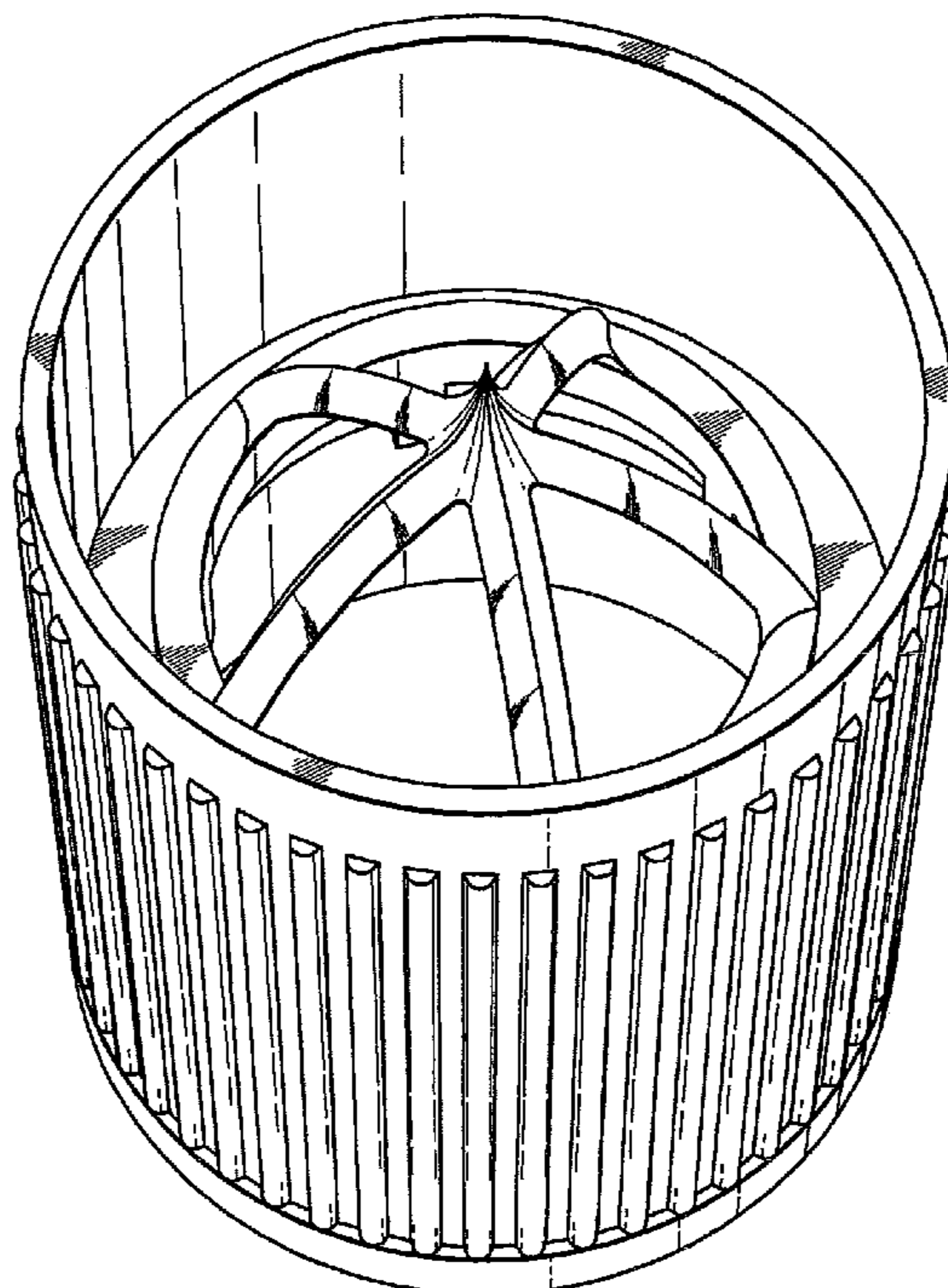

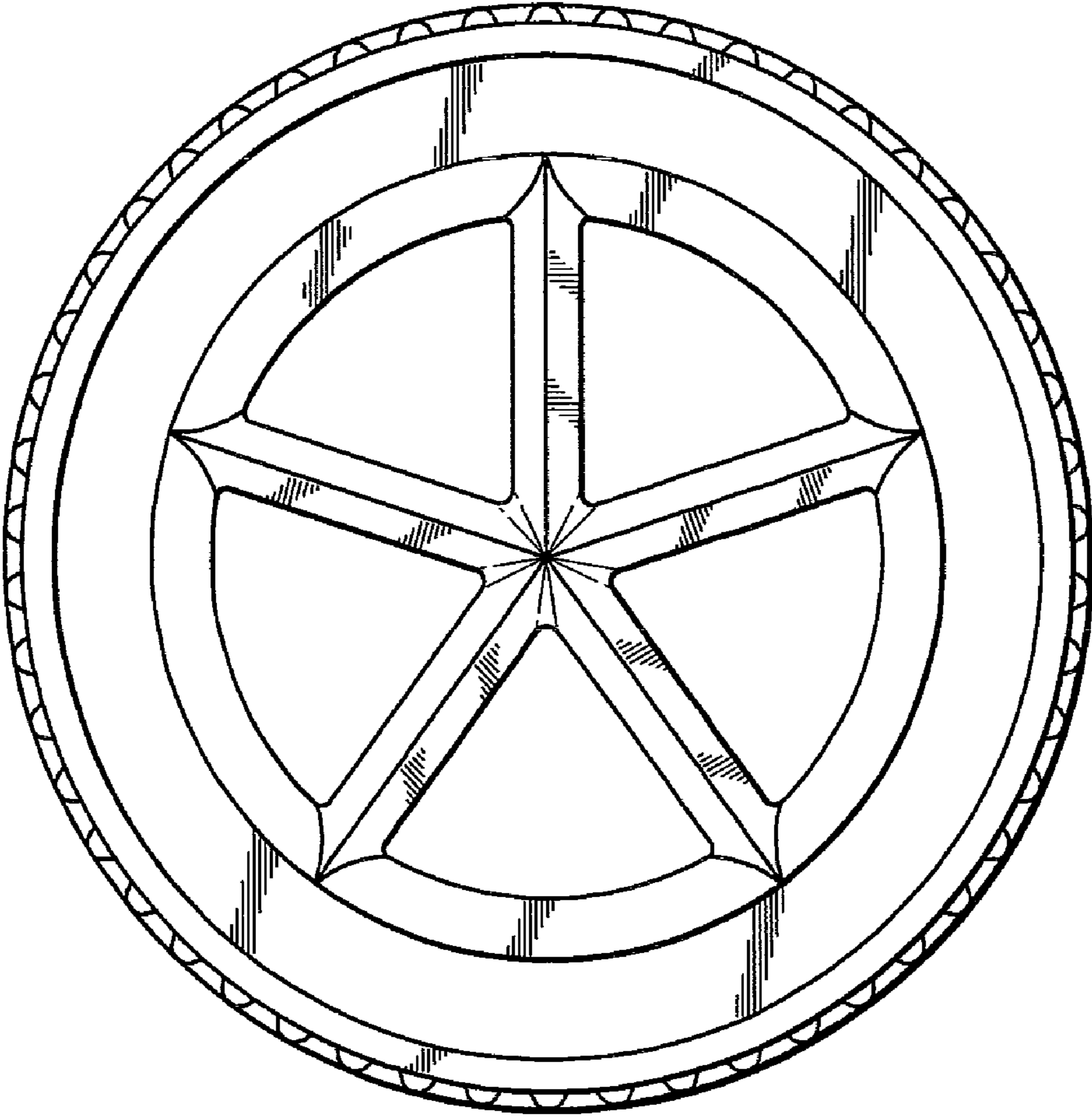

FIG. 1

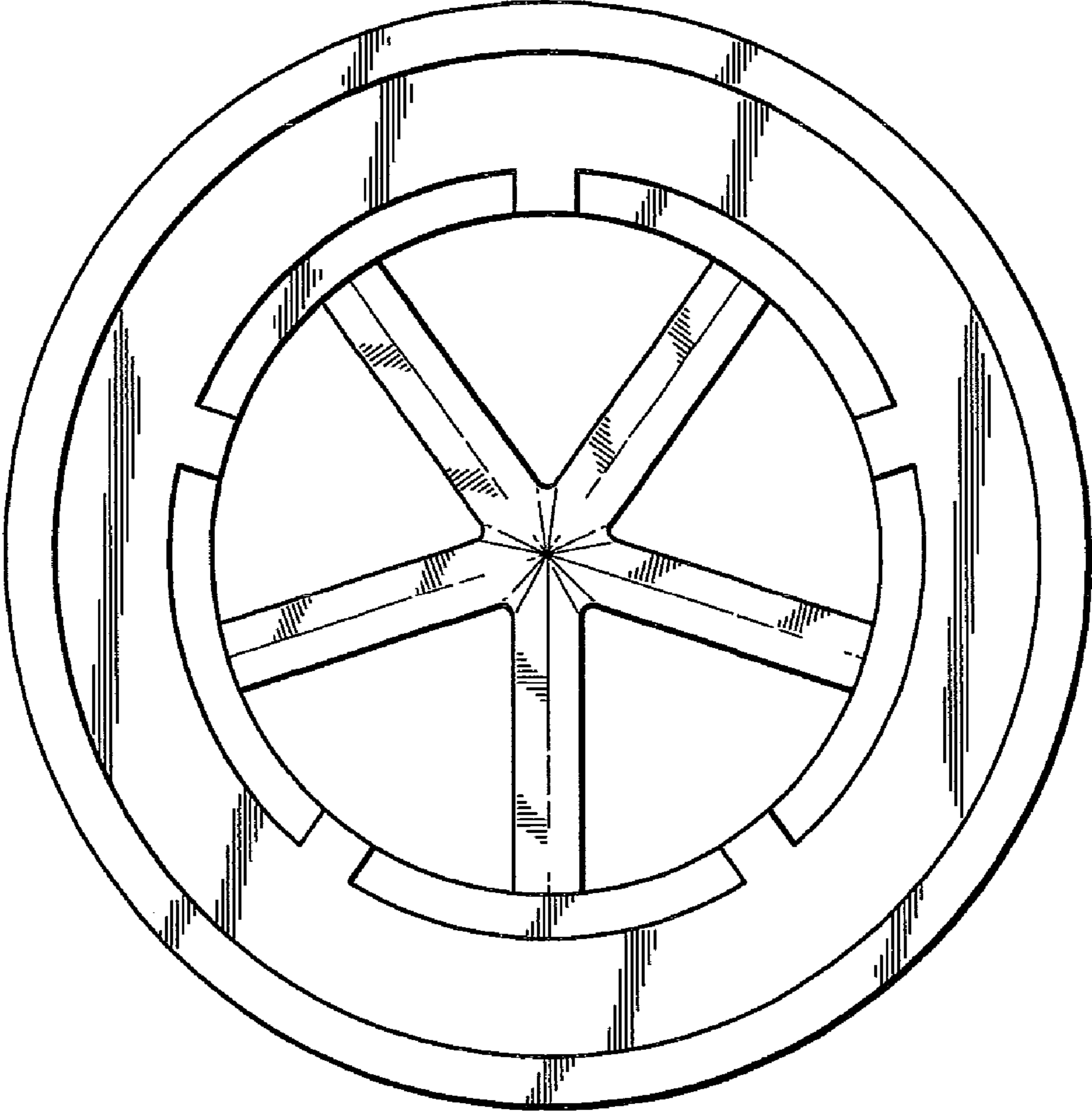

FIG. 2

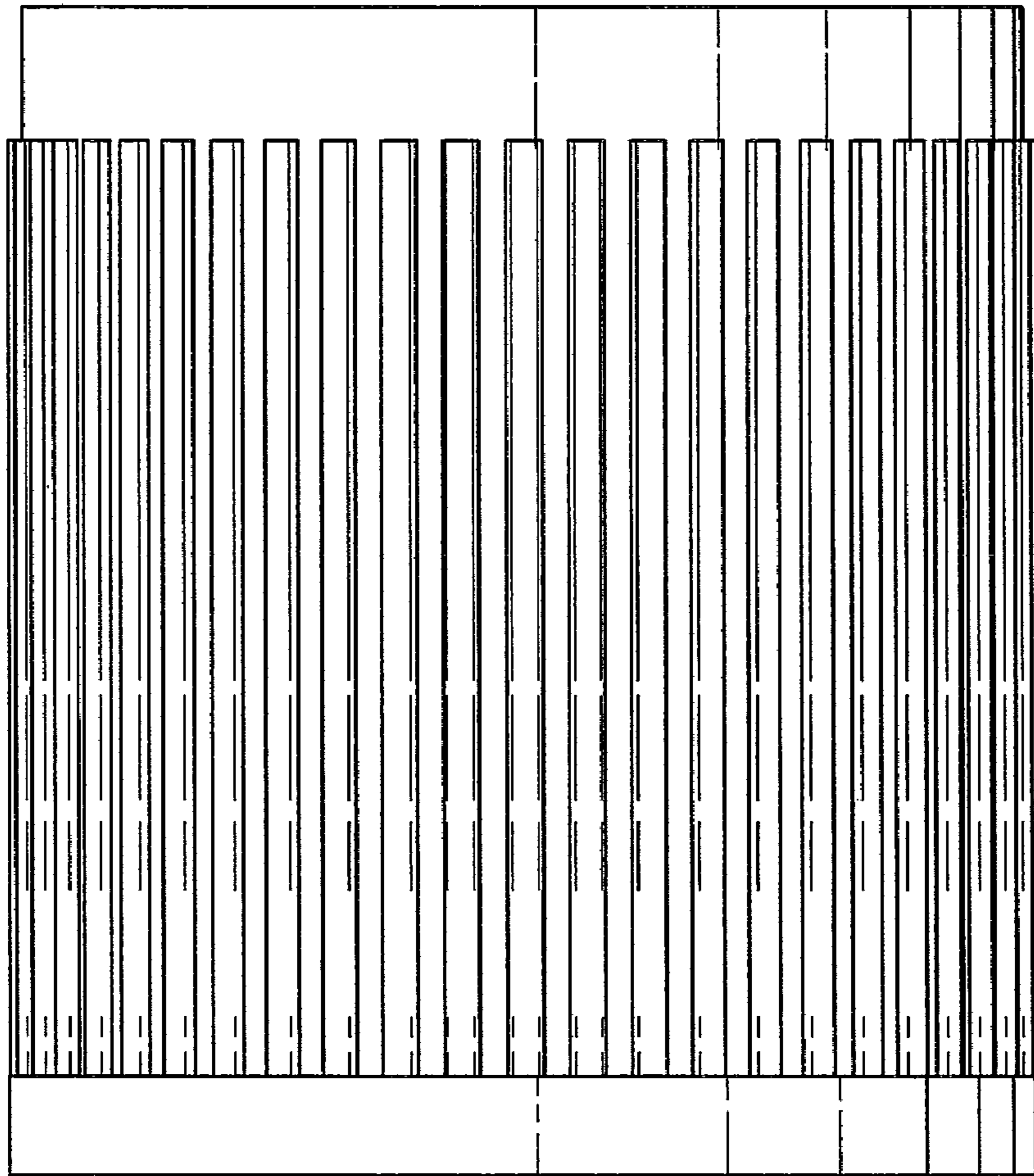

FIG. 3

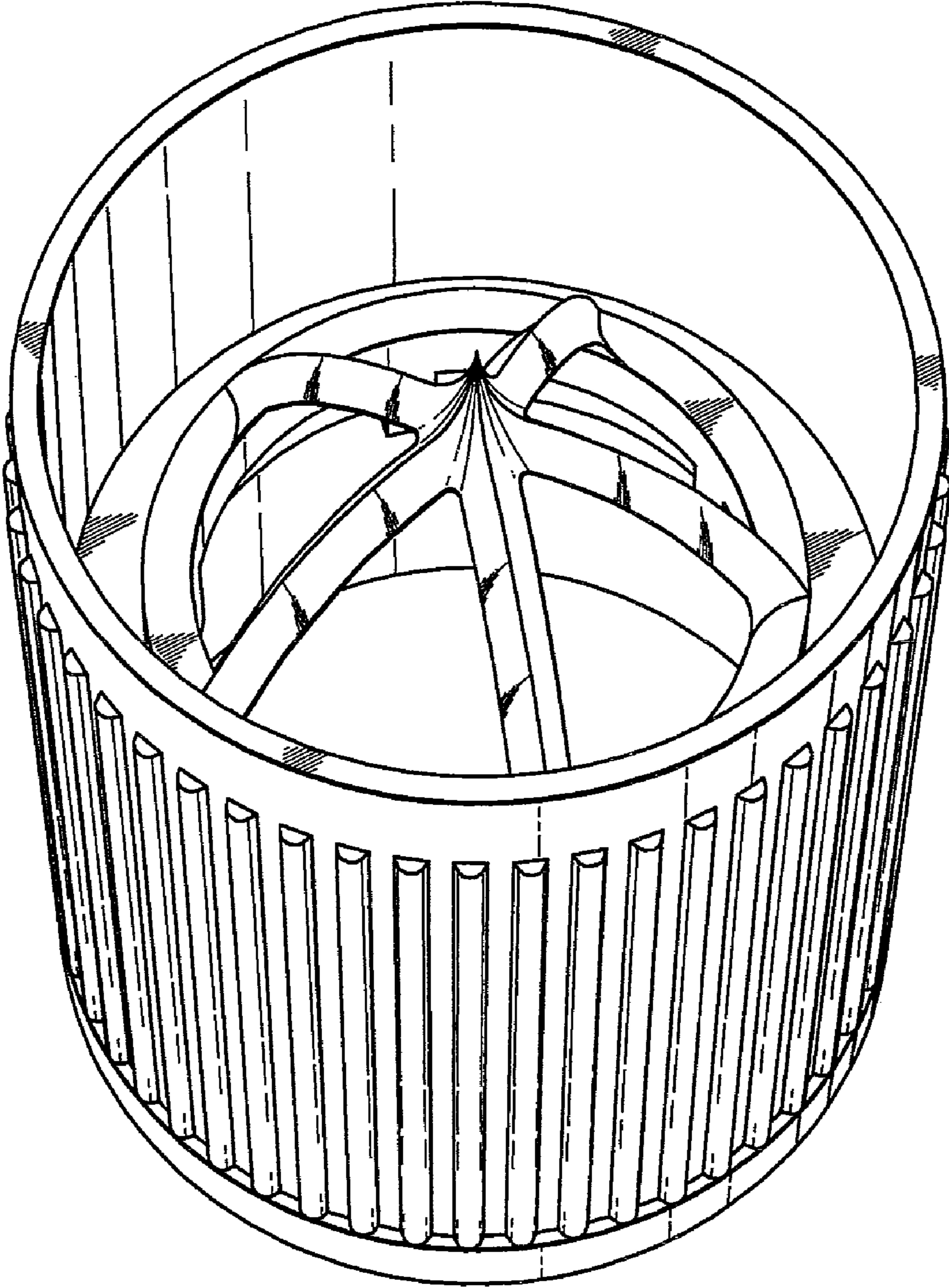

FIG. 4

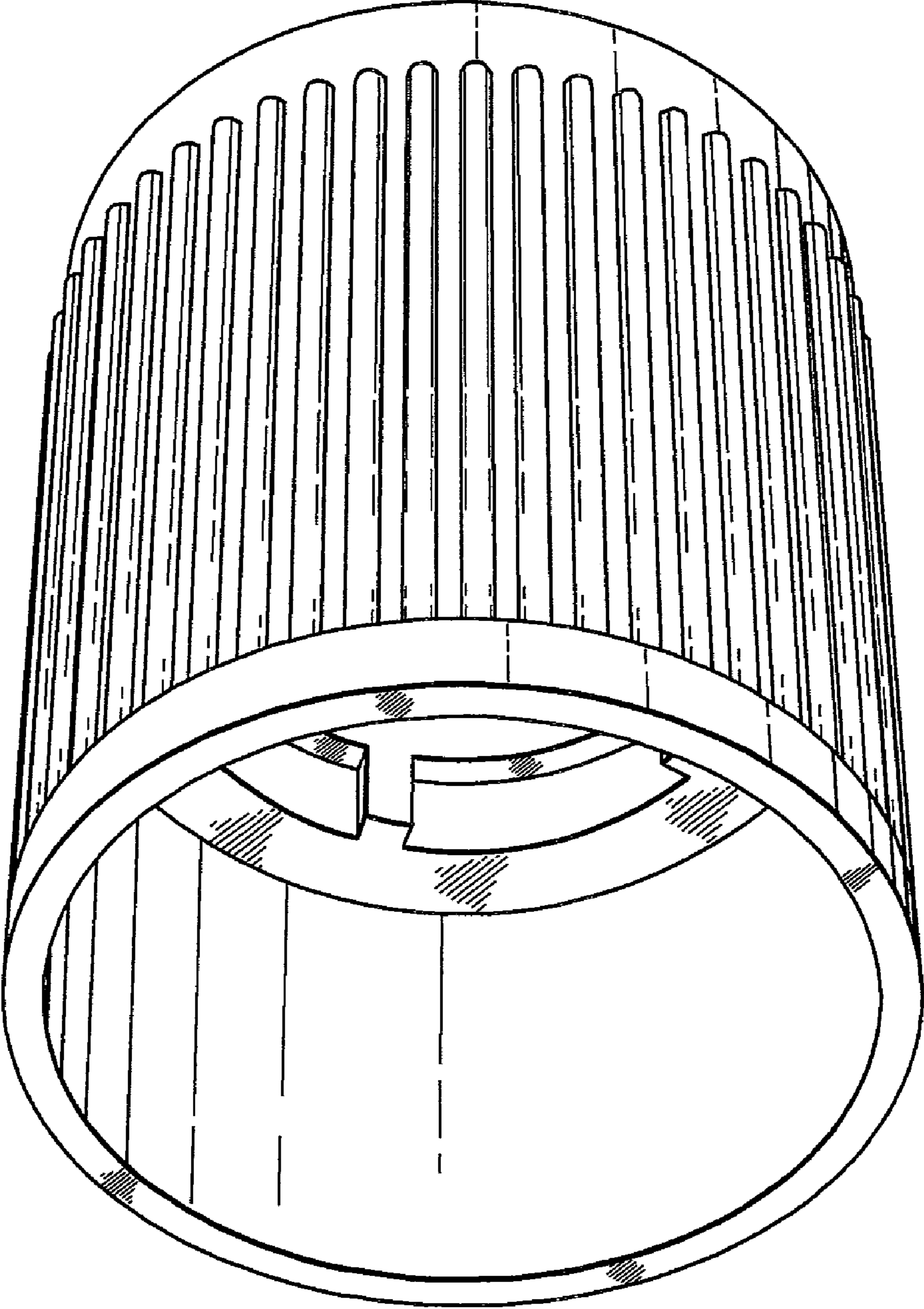

FIG. 5

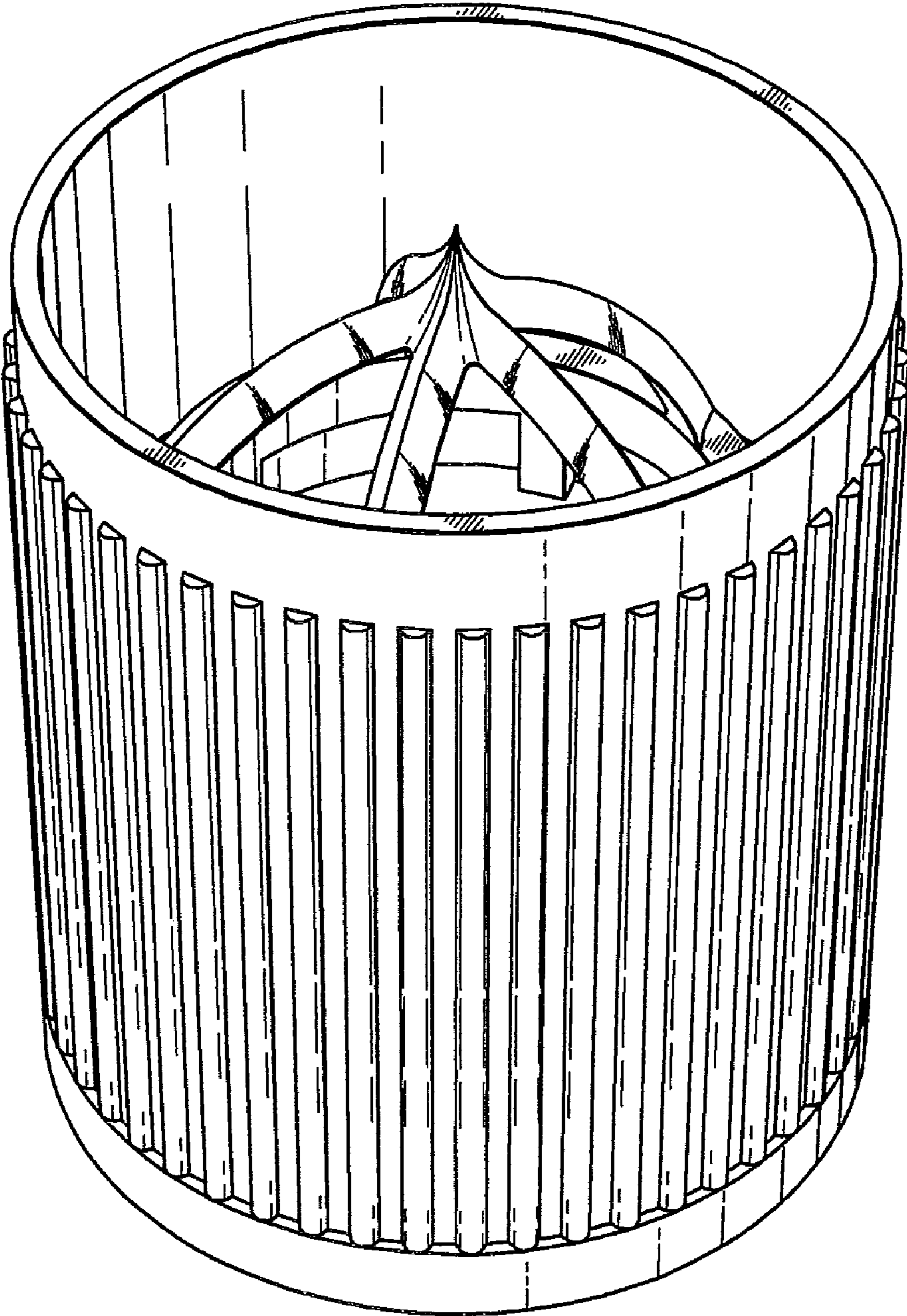

FIG. 6

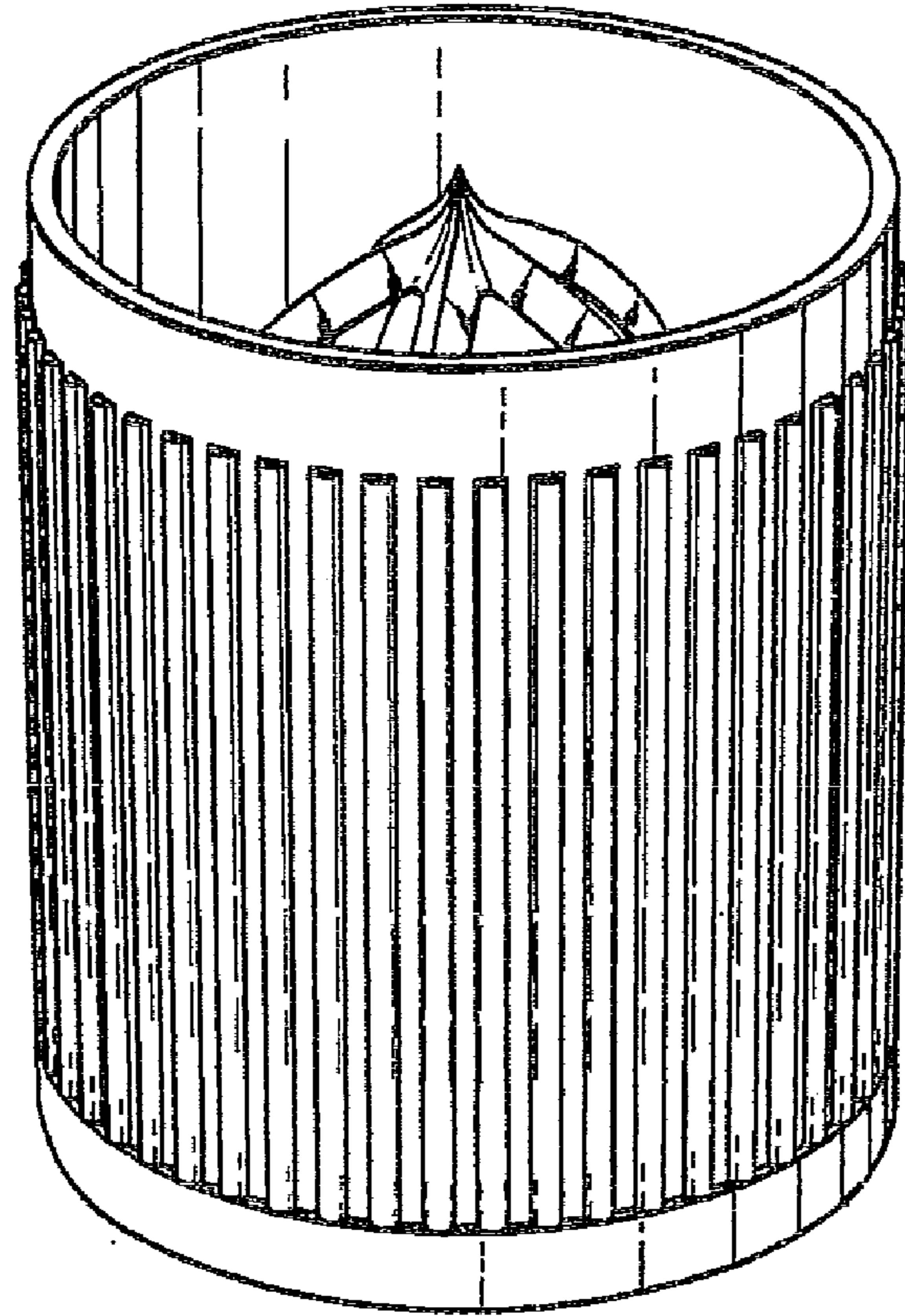

FIG. 7