



US00D637445S

(12) **United States Design Patent**
Chung et al.

(10) **Patent No.:** **US D637,445 S**

(45) **Date of Patent:** **** May 10, 2011**

(54) **TEA KETTLE**

(75) Inventors: **Daniel Young-Doo Chung**, Chicago, IL (US); **Michael A. Blanchet-Ruth**, Chicago, IL (US); **Steven E. Abueva**, Chicago, IL (US); **Michael A. Serafin**, Downers Grove, IL (US)

(73) Assignee: **Vessel Ideation, Inc.**, Chicago, IL (US)

(**) Term: **14 Years**

(21) Appl. No.: **29/352,655**

(22) Filed: **Dec. 23, 2009**

(51) **LOC (9) Cl.** **07-01**

(52) **U.S. Cl.** **D7/316; D7/505; D7/312**

(58) **Field of Classification Search** D7/505,
D7/507, 300.1, 300, 305, 316, 312, 598;
D9/500, 545, 719, 689; 220/23.83, 568,
220/575; 215/387; 222/485

See application file for complete search history.

(56) **References Cited**

U.S. PATENT DOCUMENTS

2,469,032	A	*	5/1949	Chaudron	141/381
D211,978	S	*	8/1968	Mantonne	D7/300
D240,887	S	*	8/1976	Daenes	D7/316
3,998,351	A	*	12/1976	Smith et al.	220/23.83
4,543,801	A	*	10/1985	Damiens	62/457.8
D379,901	S	*	6/1997	Lillelund et al.	D7/505
D409,051	S	*	5/1999	Huang	D7/608
D505,591	S	*	5/2005	Bodum	D7/507
D563,238	S	*	3/2008	Nevins et al.	D9/684

D604,984	S	*	12/2009	Kalamaras	D7/300.1
D610,910	S	*	3/2010	Simmons et al.	D9/529
D612,659	S	*	3/2010	Kehoe	D7/316
D620,742	S	*	8/2010	Lion et al.	D7/316

* cited by examiner

Primary Examiner — Marianne Pandozzi

(57) **CLAIM**

The ornamental design for a tea kettle, as shown and described.

DESCRIPTION

FIG. 1 is a perspective view of a tea kettle showing our new design;
 FIG. 2 is a side view thereof;
 FIG. 3 is a top plan view thereof;
 FIG. 4 is a bottom plan view thereof;
 FIG. 5 is a side view of the tea kettle showing the bottom piece only with the upper pieces removed for ease of illustration;
 FIG. 6 is a top plan view thereof;
 FIG. 7 is a bottom plan view thereof;
 FIG. 8 is an exploded perspective view of the tea kettle;
 FIG. 9 is a top plan view of the tea kettle showing the middle piece with the rest of the pieces removed for ease of illustration;
 FIG. 10 is a side elevational view thereof;
 FIG. 11 is a bottom plan view thereof;
 FIG. 12 is a side view of the tea kettle showing the top piece with the lower pieces removed for ease of illustration;
 FIG. 13 is a top plan view thereof; and,
 FIG. 14 is a bottom plan view thereof.

1 Claim, 14 Drawing Sheets

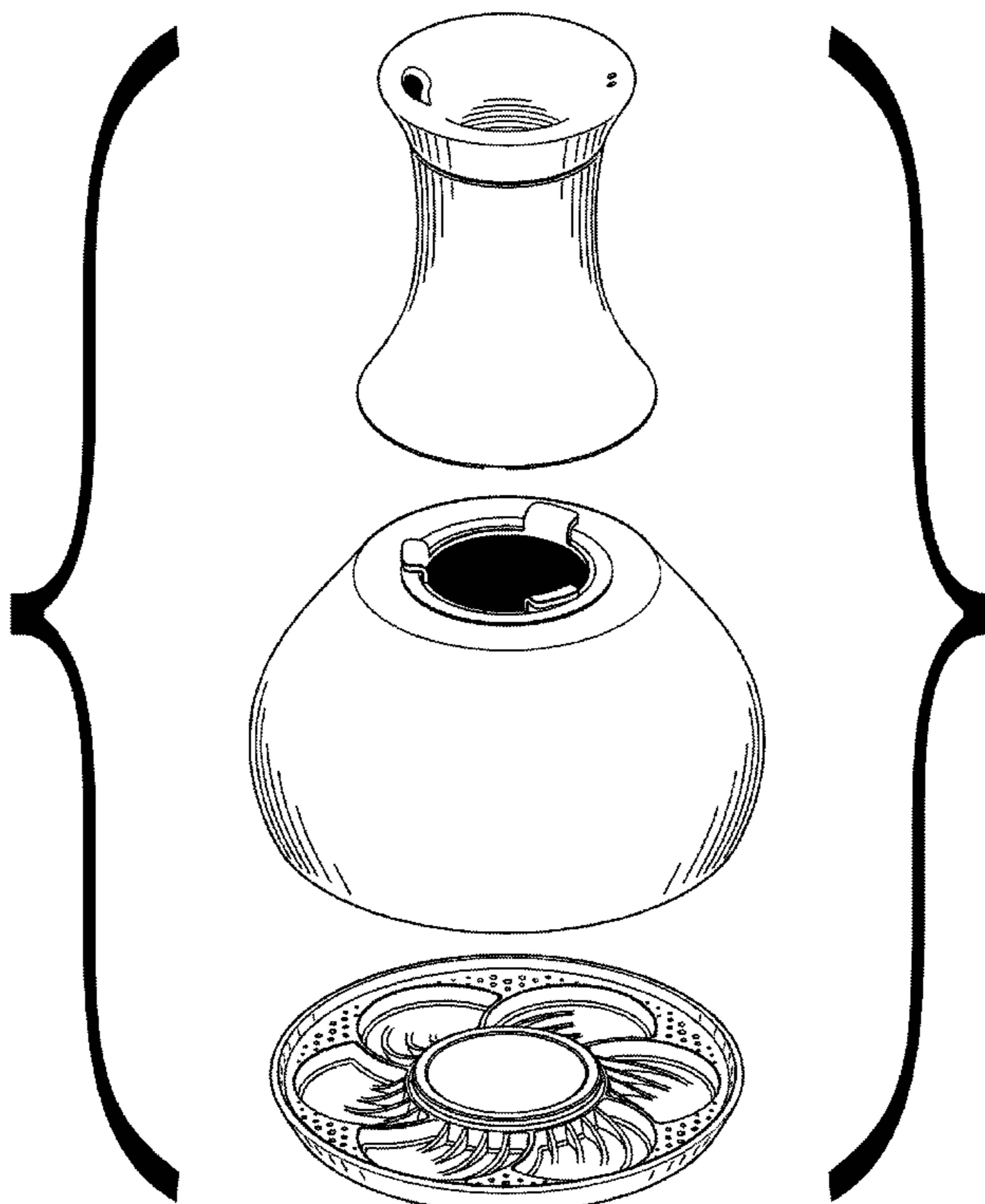

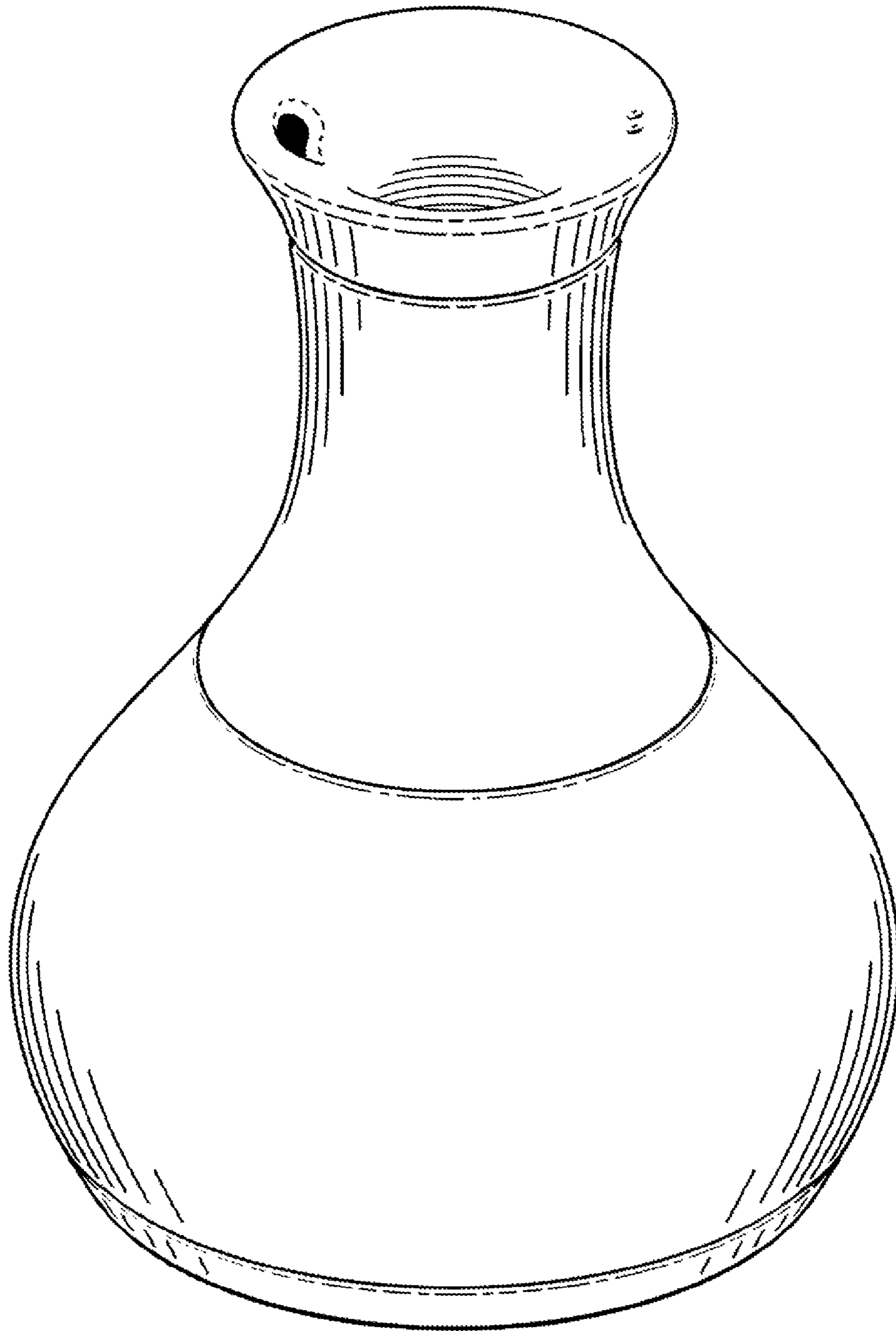

Fig. 1

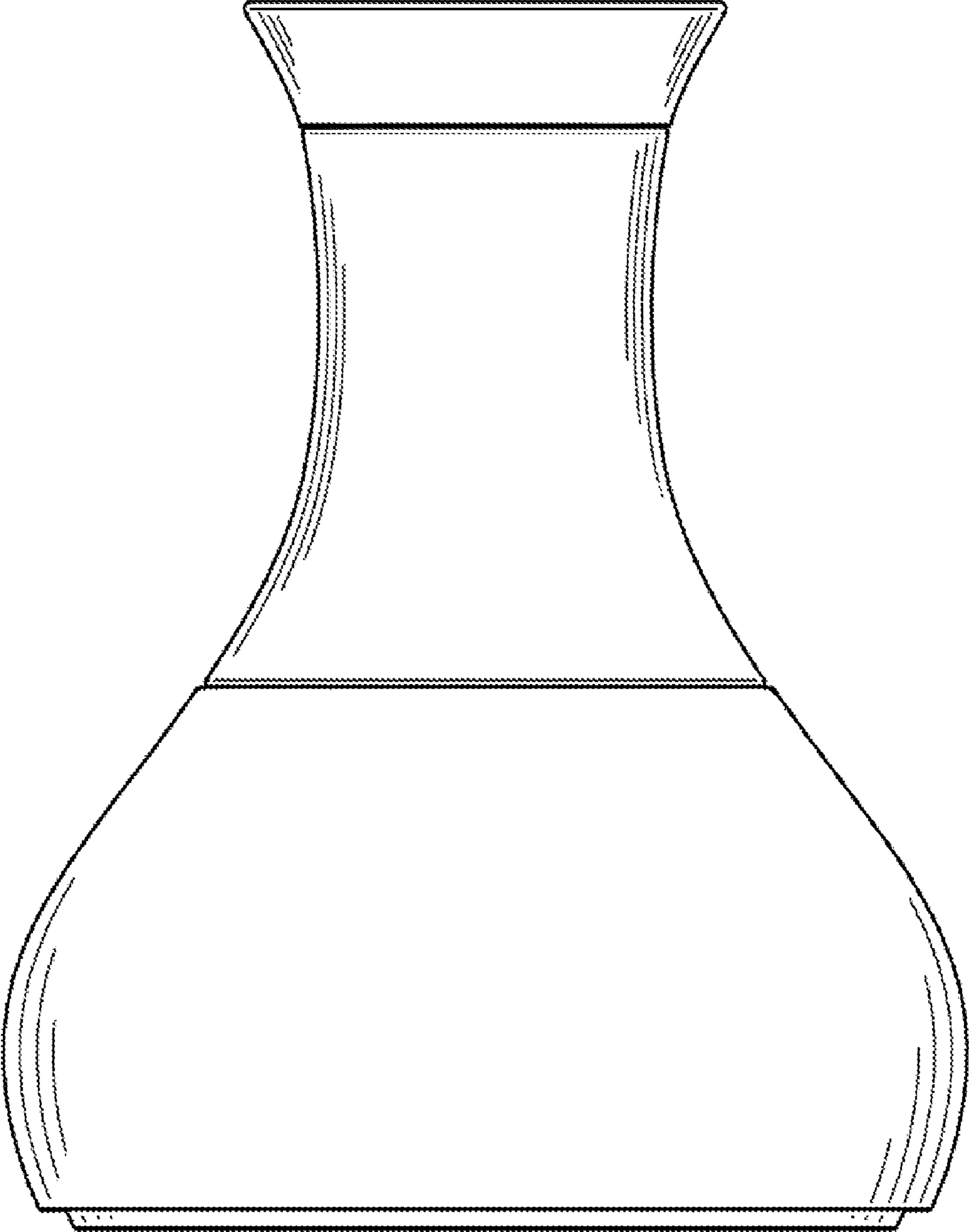

Fig. 2

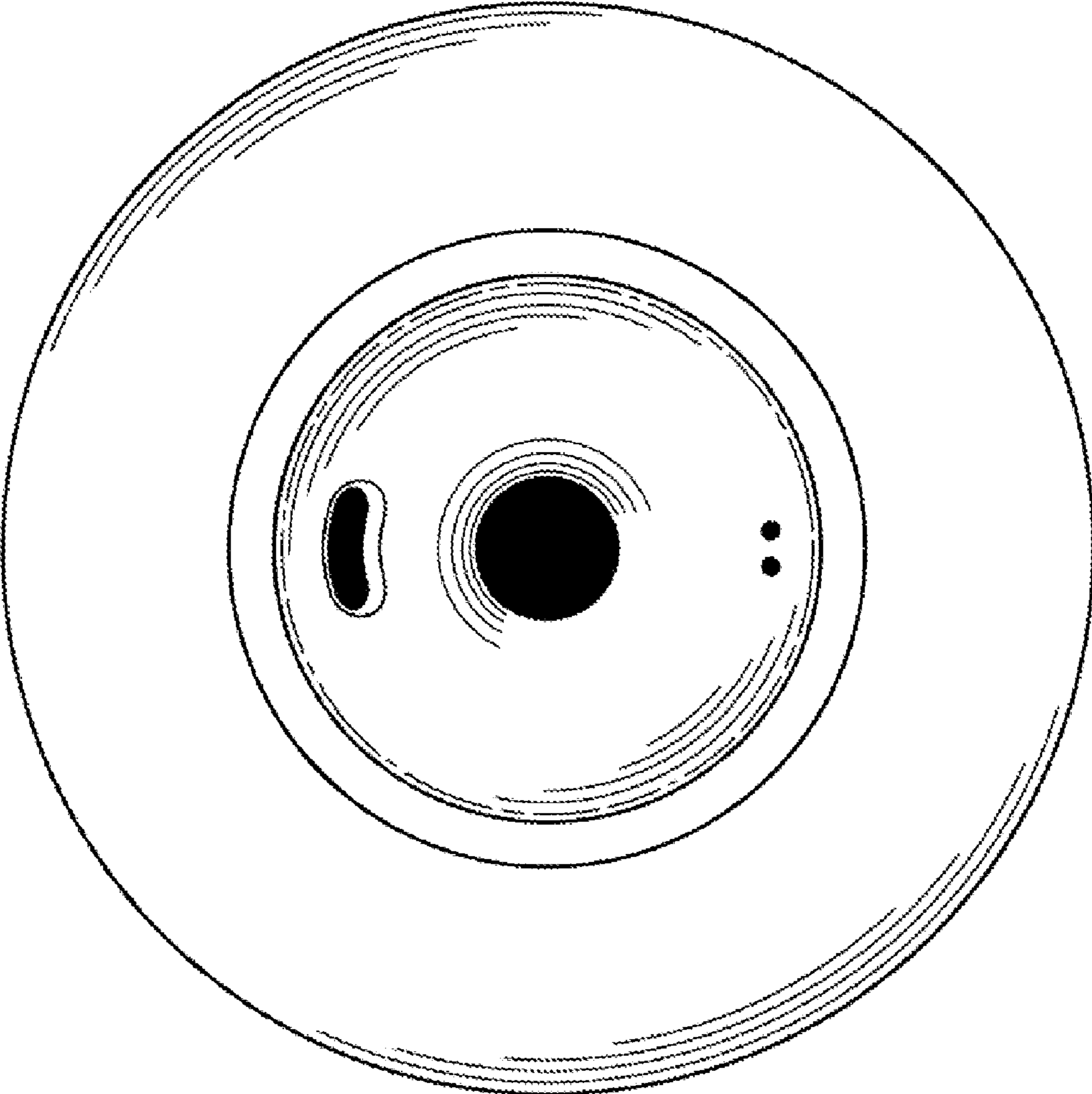

Fig. 3

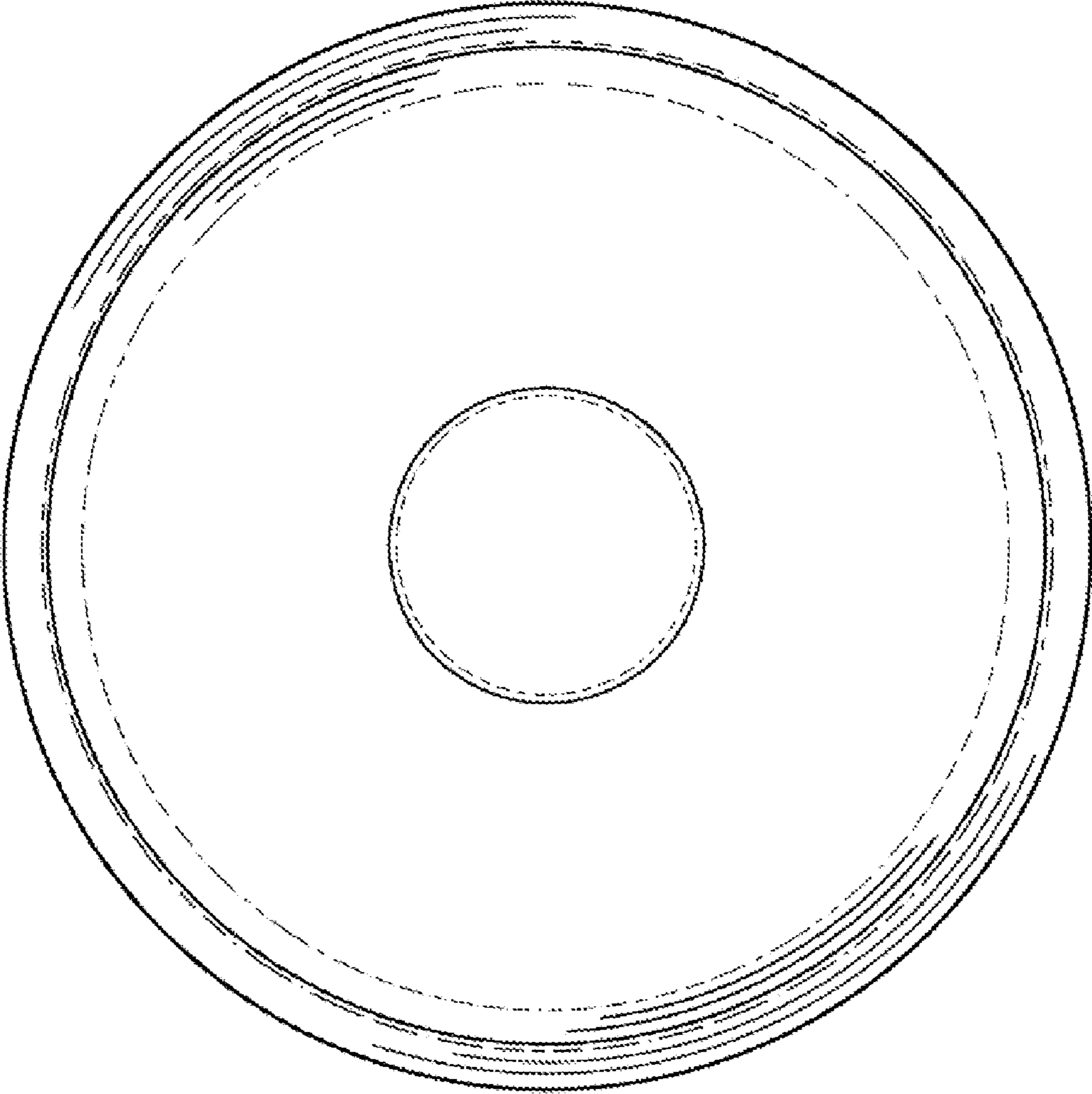

Fig. 4



Fig. 5

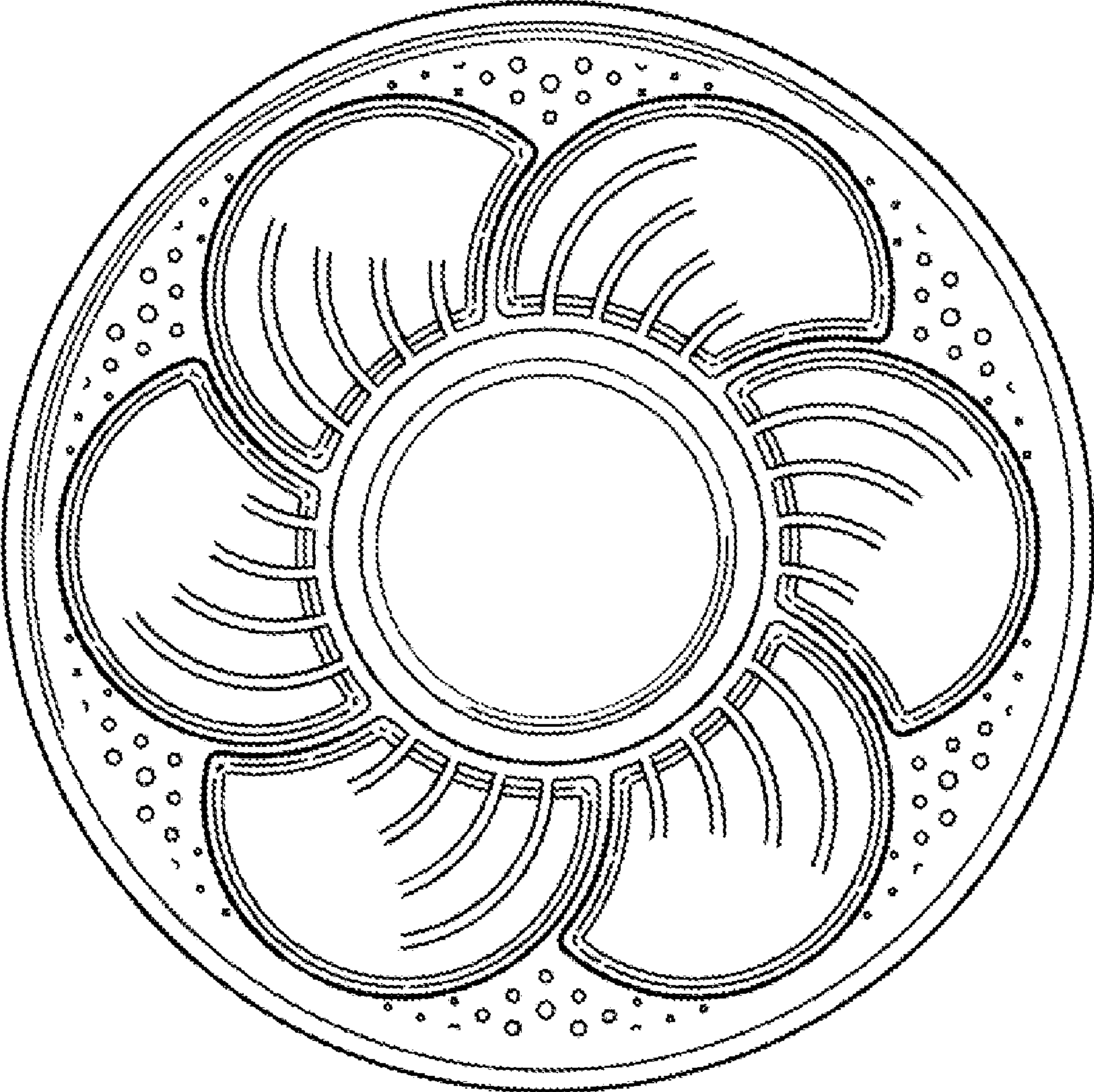

Fig. 6

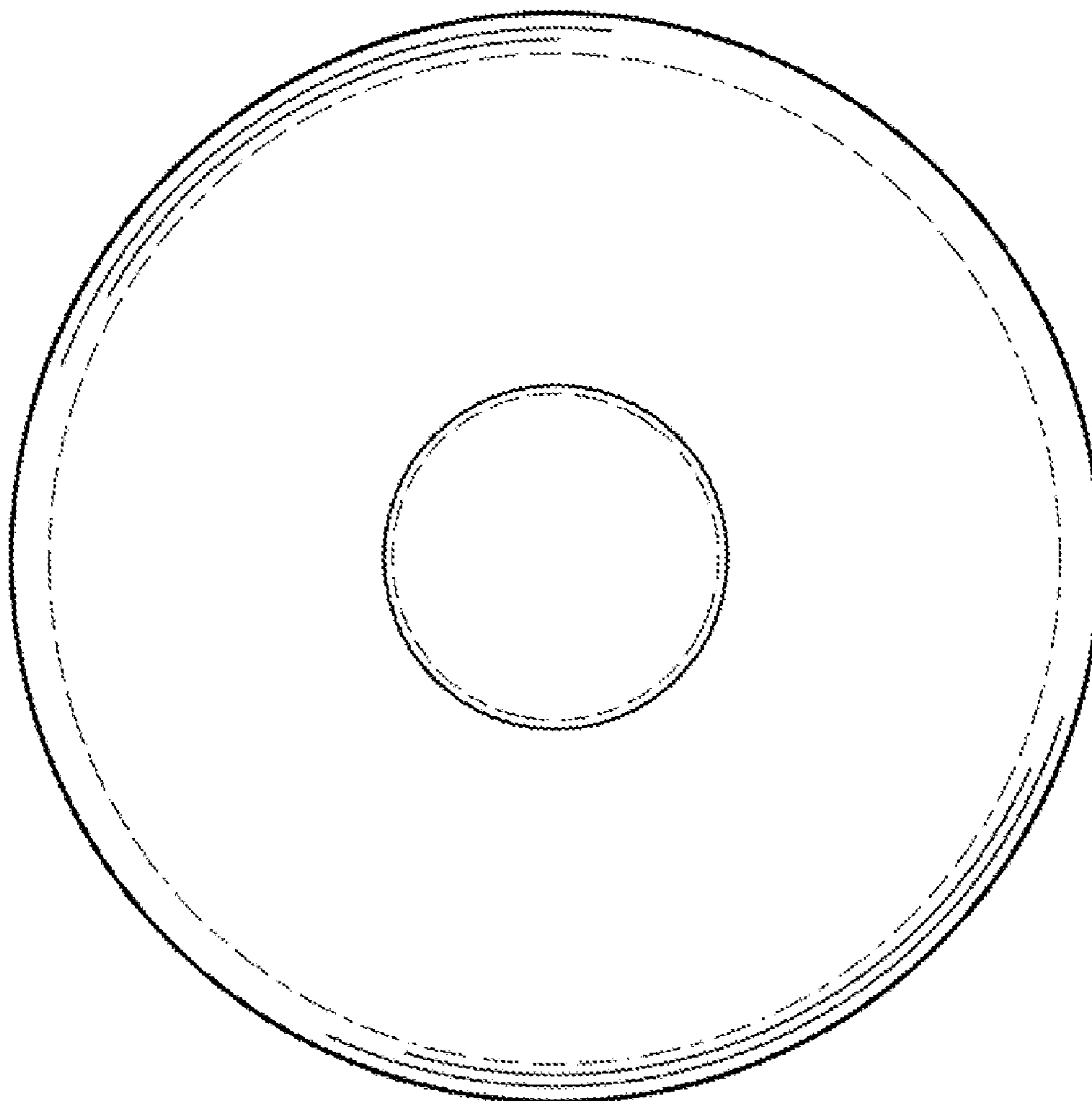

Fig. 7

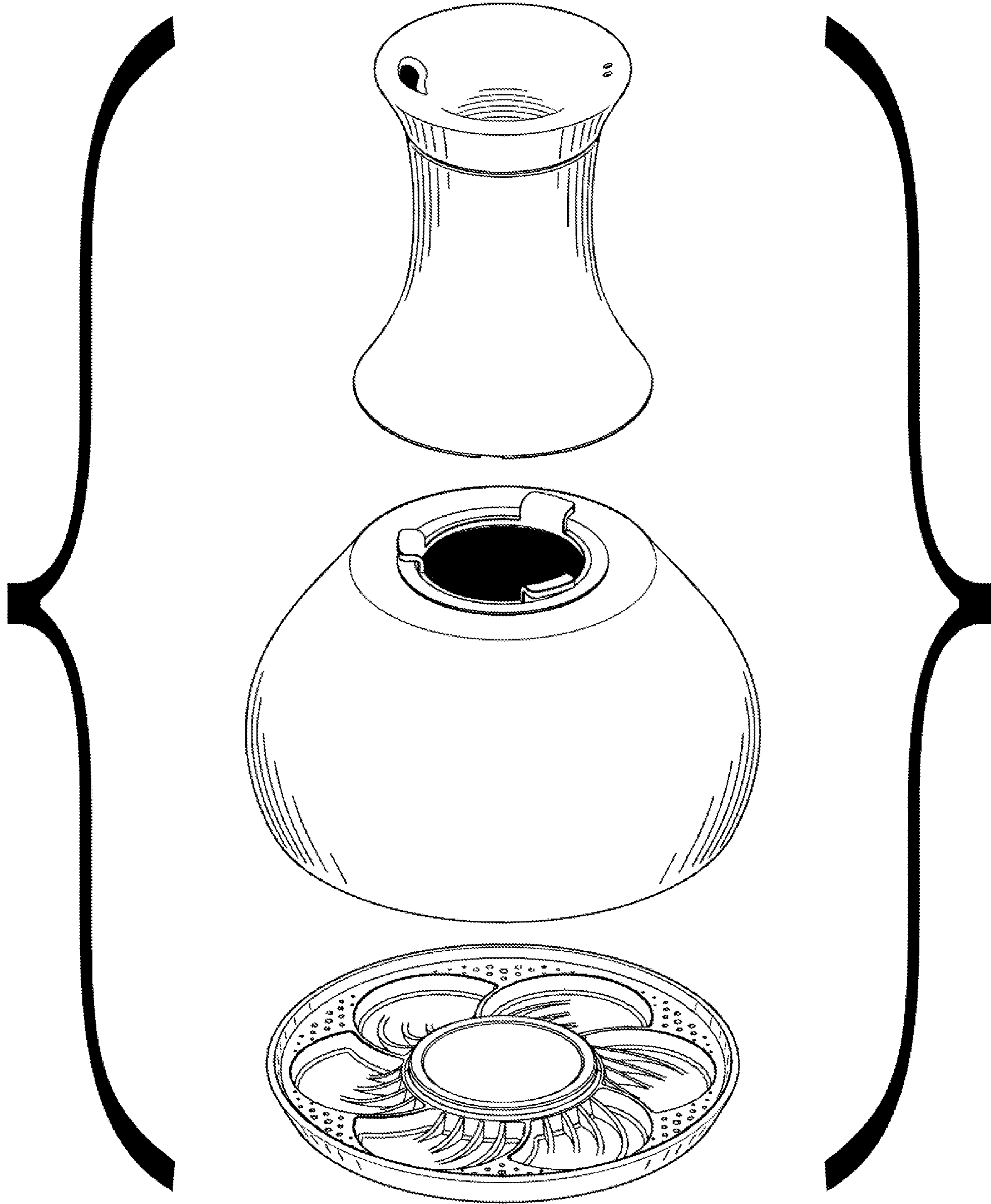

Fig. 8

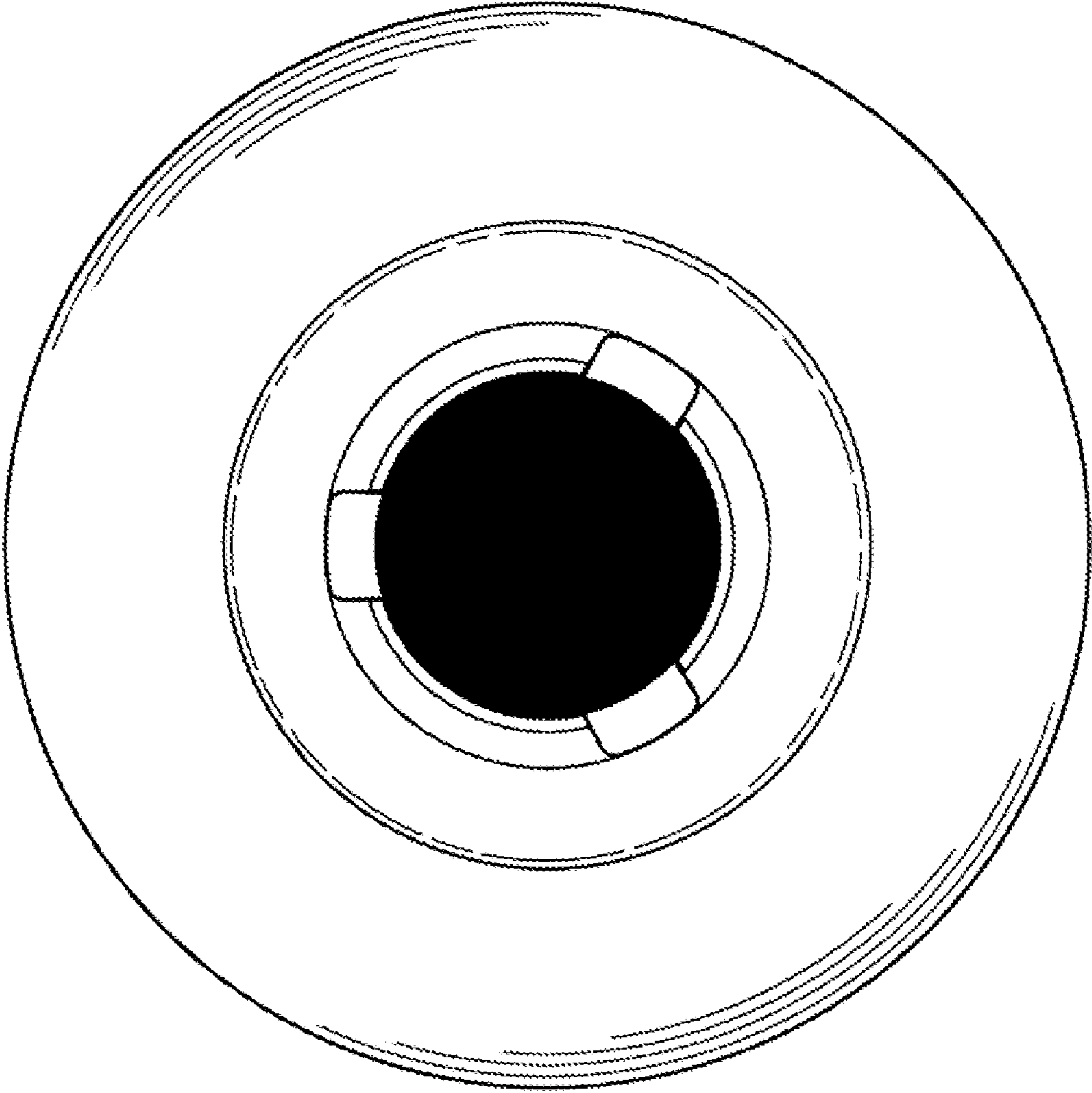

Fig. 9

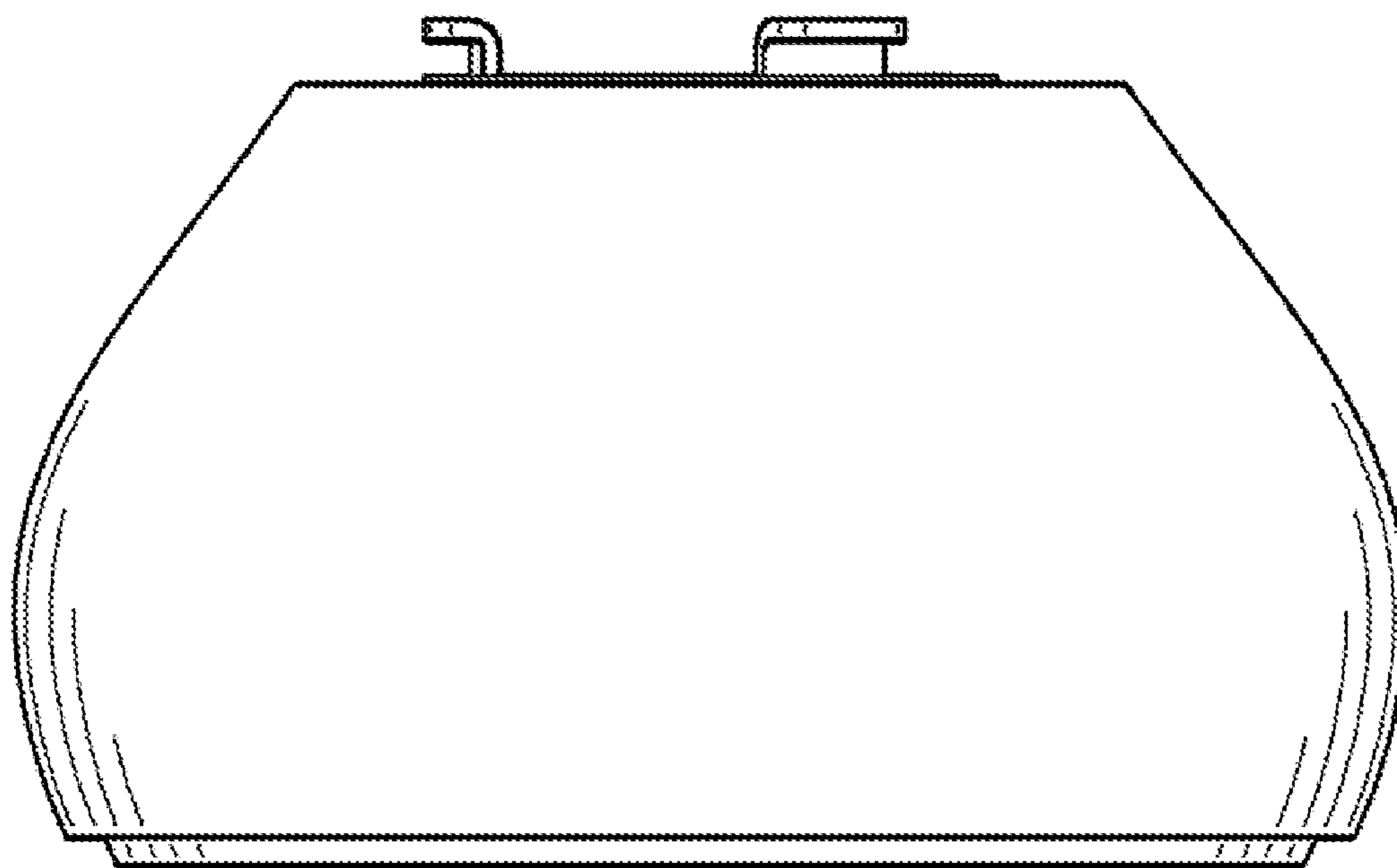

Fig. 10

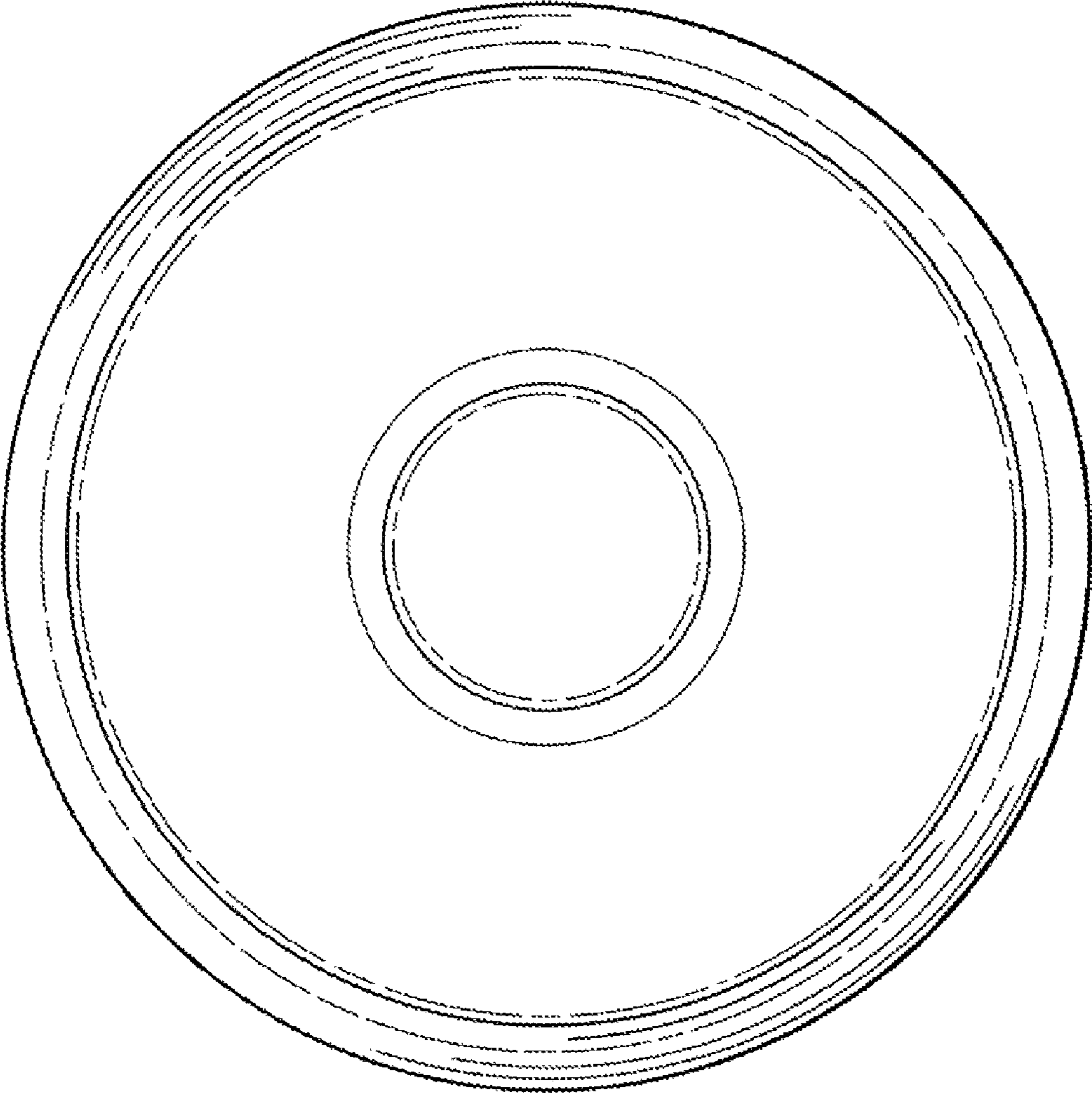

Fig. 11

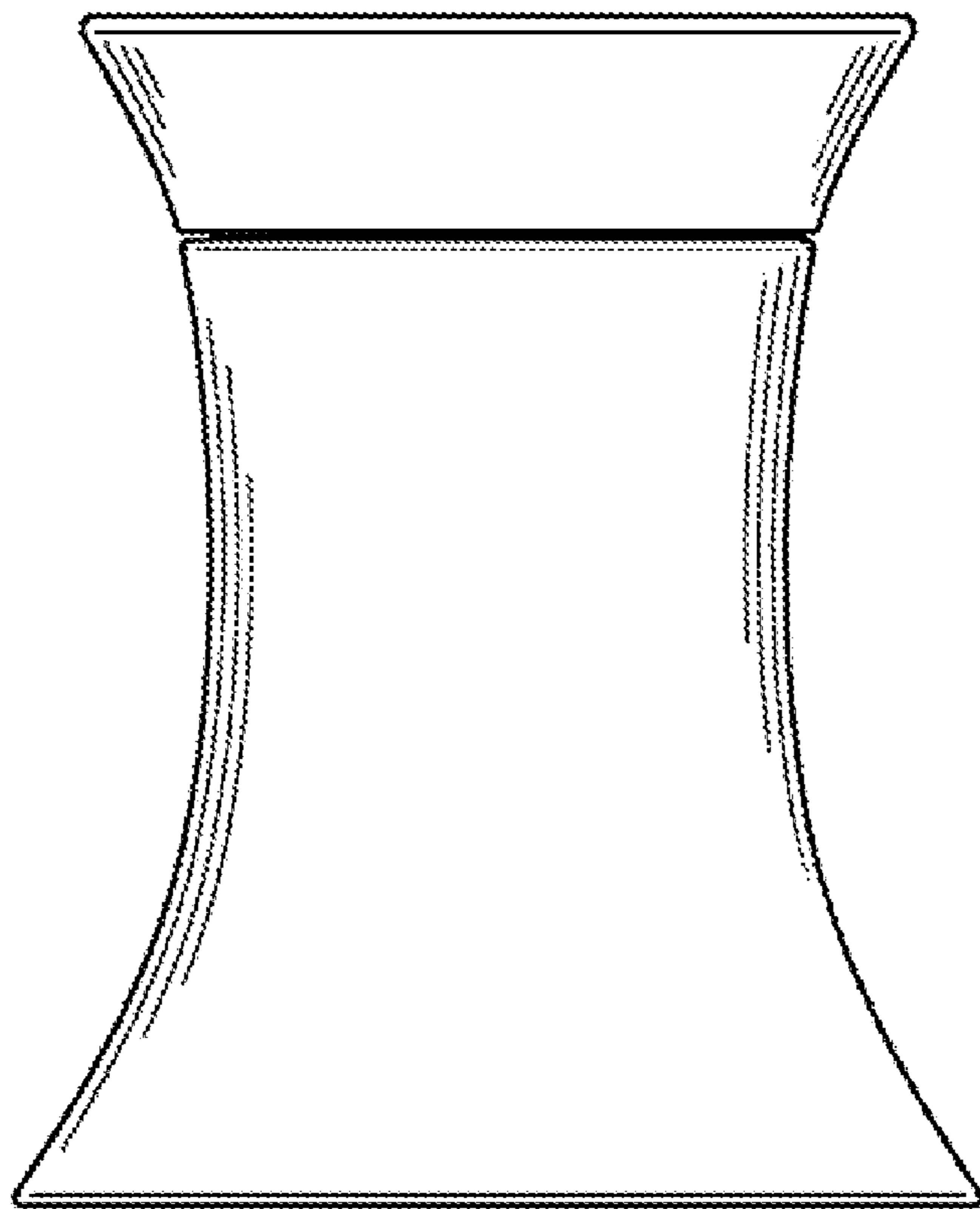

Fig. 12

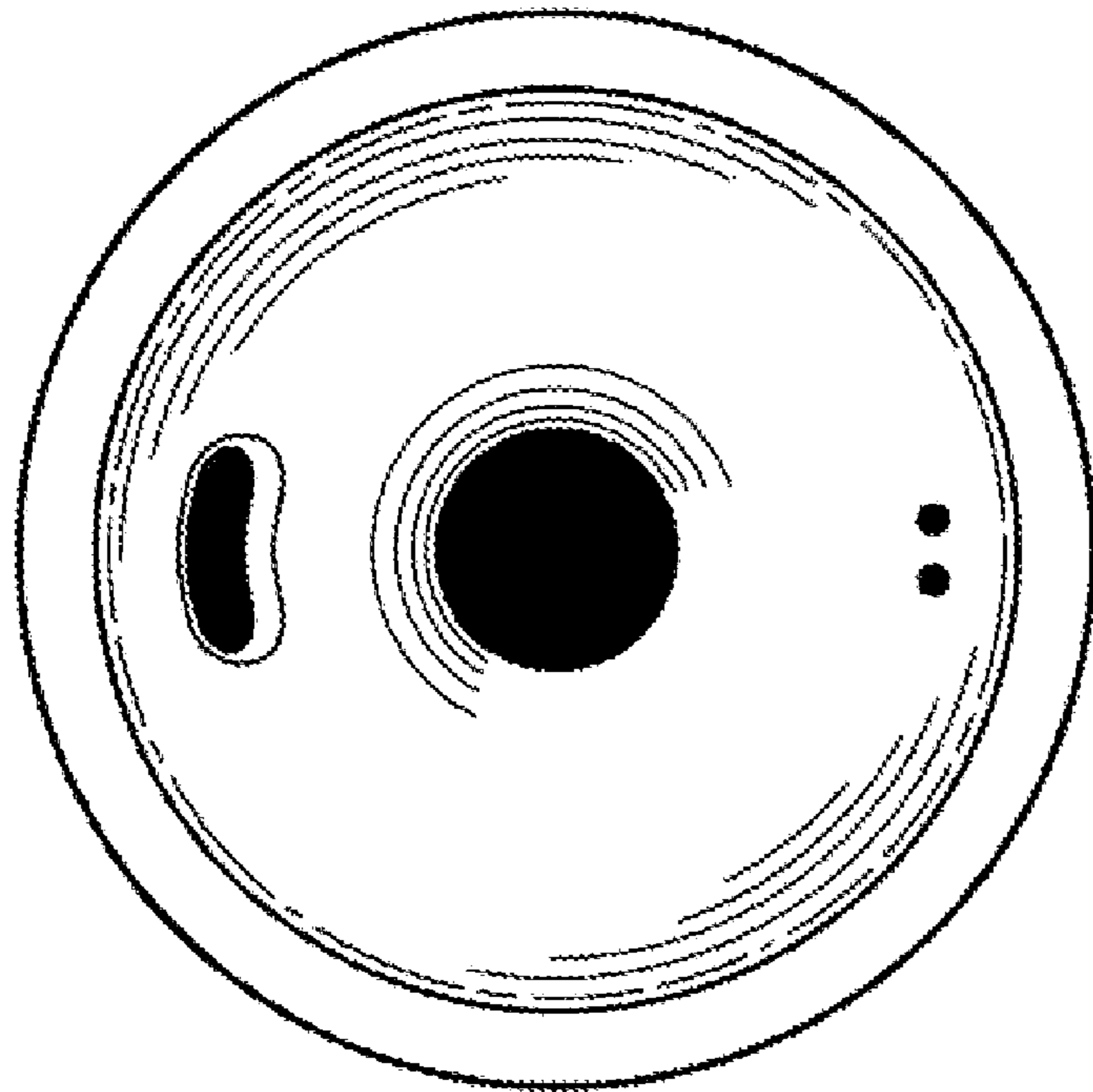

Fig. 13

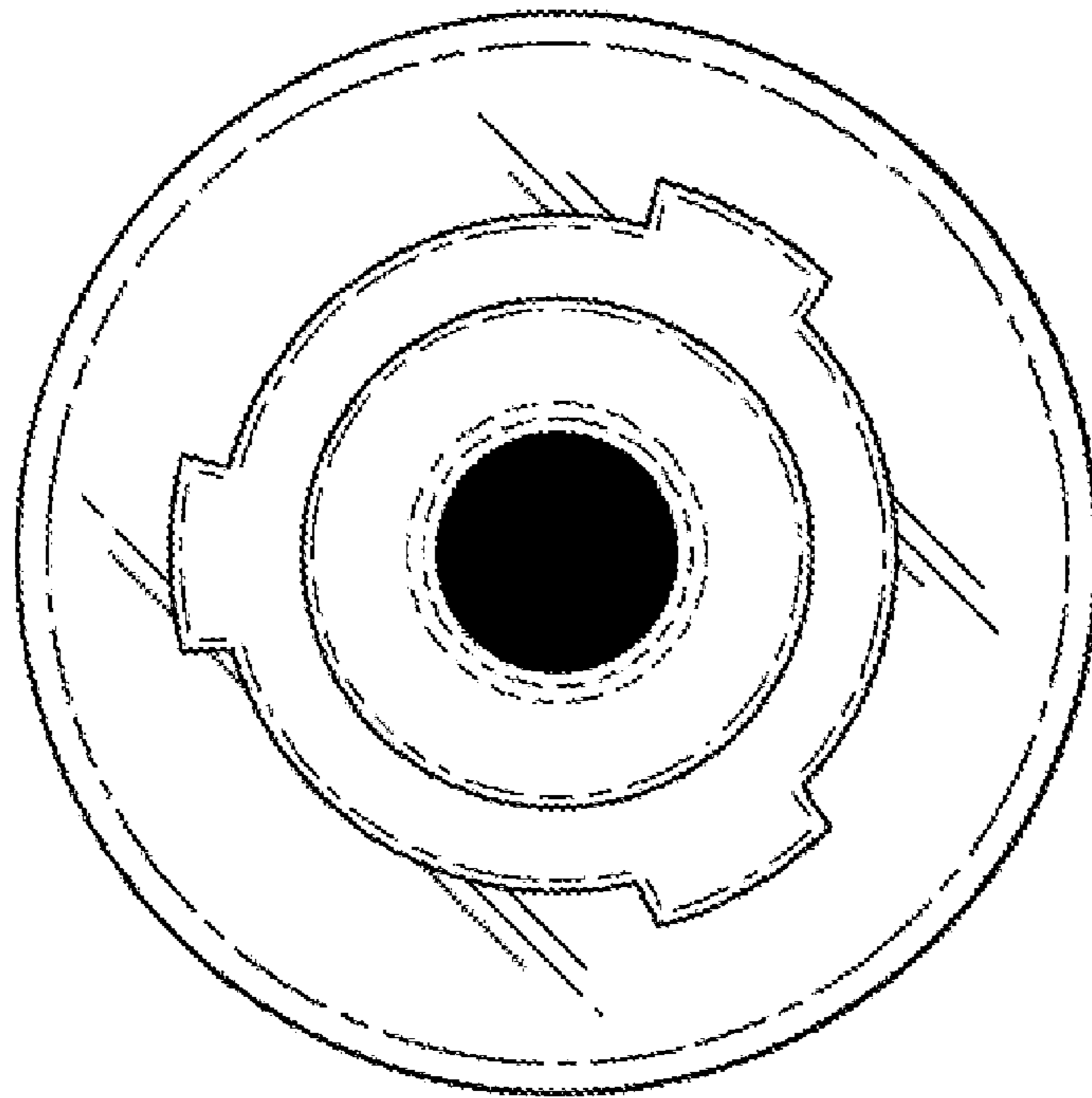

Fig. 14