



US00D637439S

(12) **United States Design Patent**  
**Mettler**

(10) **Patent No.:** **US D637,439 S**

(45) **Date of Patent:** **\*\* May 10, 2011**

(54) **PILLOW**

(76) **Inventor:** **Paul Richard Mettler**, Champaign, IL  
(US)

(\*\*) **Term:** **14 Years**

(21) **Appl. No.:** **29/362,856**

(22) **Filed:** **Jun. 1, 2010**

(51) **LOC (9) Cl.** ..... **06-09**

(52) **U.S. Cl.** ..... **D6/601**

(58) **Field of Classification Search** ..... D6/595-601,  
D6/604, 606, 610-611; 5/630, 632, 633,  
5/636-640, 642, 644-646, 648, 652-655,  
5/655.3, 655.9, 656, 657.5; D3/276; D21/803;  
D24/183; D30/118  
See application file for complete search history.

6,532,611	B1	3/2003	Day	
6,554,363	B1	4/2003	Silva	
6,648,416	B2	11/2003	O'Connor et al.	
6,671,906	B1	1/2004	Milligan	
6,701,555	B1	3/2004	Ermini	
6,742,207	B1	6/2004	Brown	
6,817,049	B1	11/2004	Hall	
6,957,462	B1	10/2005	Wilcox	
7,024,712	B2 *	4/2006	Fujita et al.	5/653
7,448,101	B2 *	11/2008	Millar	5/646
D595,526	S *	7/2009	Mills et al.	D6/601
D595,986	S *	7/2009	Kloes et al.	D6/601
7,707,668	B2 *	5/2010	Kloes et al.	5/636
D624,777	S *	10/2010	Pepys	D6/601

(Continued)

*Primary Examiner* — Mary Ann Calabrese  
(74) *Attorney, Agent, or Firm* — Hitchcock Evert LLP

(57) **CLAIM**  
The ornamental design for a pillow, as shown and described.

(56) **References Cited**

U.S. PATENT DOCUMENTS

4,918,774	A	4/1990	Popitz	
4,924,540	A	5/1990	Main	
5,020,174	A	6/1991	Sarkozi	
5,029,351	A *	7/1991	Weber	5/655
5,134,740	A *	8/1992	Summer	5/652
5,154,649	A *	10/1992	Pender	5/655
5,471,690	A	12/1995	McNeil	
D389,645	S *	1/1998	Ermini	D3/276
5,926,880	A	7/1999	Sramek	
5,987,674	A	11/1999	Schaffner et al.	
D418,711	S	1/2000	Mettler	
6,009,577	A	1/2000	Day	
D420,845	S	2/2000	Rumage	
6,052,848	A	4/2000	Kelly	
6,055,687	A	5/2000	Matthews	
6,135,560	A	10/2000	Fagg	
6,233,767	B1	5/2001	Horowitz	
6,292,964	B1	9/2001	Rose et al.	
6,327,725	B1	12/2001	Veilleux et al.	
6,347,421	B1	2/2002	D'Emilio	
6,381,784	B1	5/2002	Davis et al.	
6,394,554	B1	5/2002	Hingle	
6,446,288	B1	9/2002	Pi	
6,457,195	B1	10/2002	Holste	

**DESCRIPTION**

FIG. 1 is a front-top perspective view of a pillow;  
FIG. 2 is a front view thereof;  
FIG. 3 is a back view thereof;  
FIG. 4 is a right side view thereof;  
FIG. 5 is a left side view thereof;  
FIG. 6 is a top view thereof;  
FIG. 7 is a bottom view thereof;  
FIG. 8 is a back-bottom perspective view thereof;  
FIG. 9 is a front-top perspective view of a second embodiment of a pillow;  
FIG. 10 is a front view thereof;  
FIG. 11 is a back view thereof;  
FIG. 12 is a right side view thereof;  
FIG. 13 is a left side view thereof;  
FIG. 14 is a top view thereof  
FIG. 15 is a bottom view thereof; and,  
FIG. 16 is a back-bottom perspective view thereof.  
FIGS. 9 through 16 are shown broken apart to indicate no specific length and height.

**1 Claim, 12 Drawing Sheets**

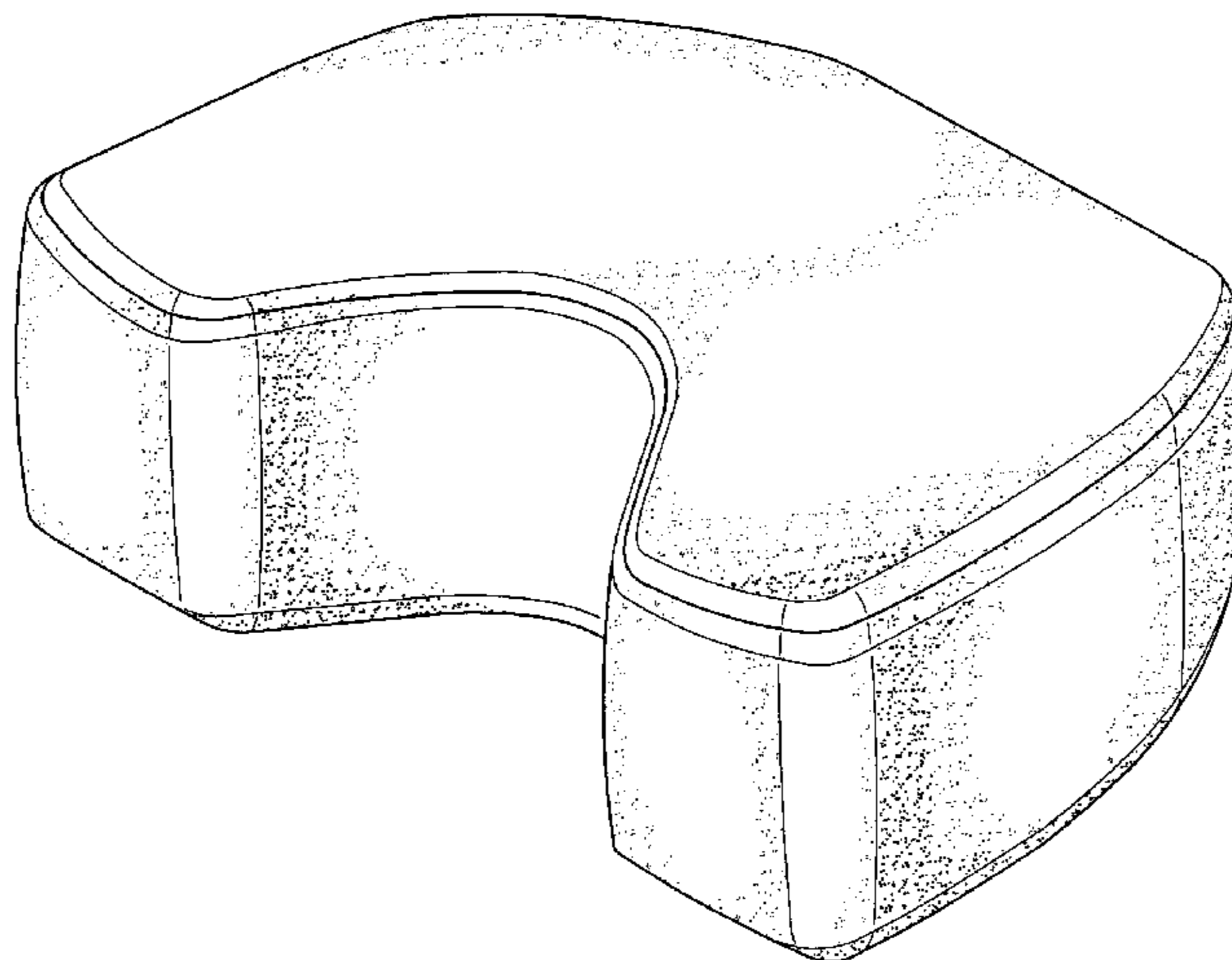

# US D637,439 S

Page 2

---

## U.S. PATENT DOCUMENTS

2002/0050007 A1 5/2002 Kim  
2003/0182725 A1 10/2003 Baik  
2005/0050637 A1 3/2005 Graebe

2007/0220678 A1 9/2007 Ciliento  
2009/0211031 A1\* 8/2009 Kloes et al. .... 5/640

\* cited by examiner

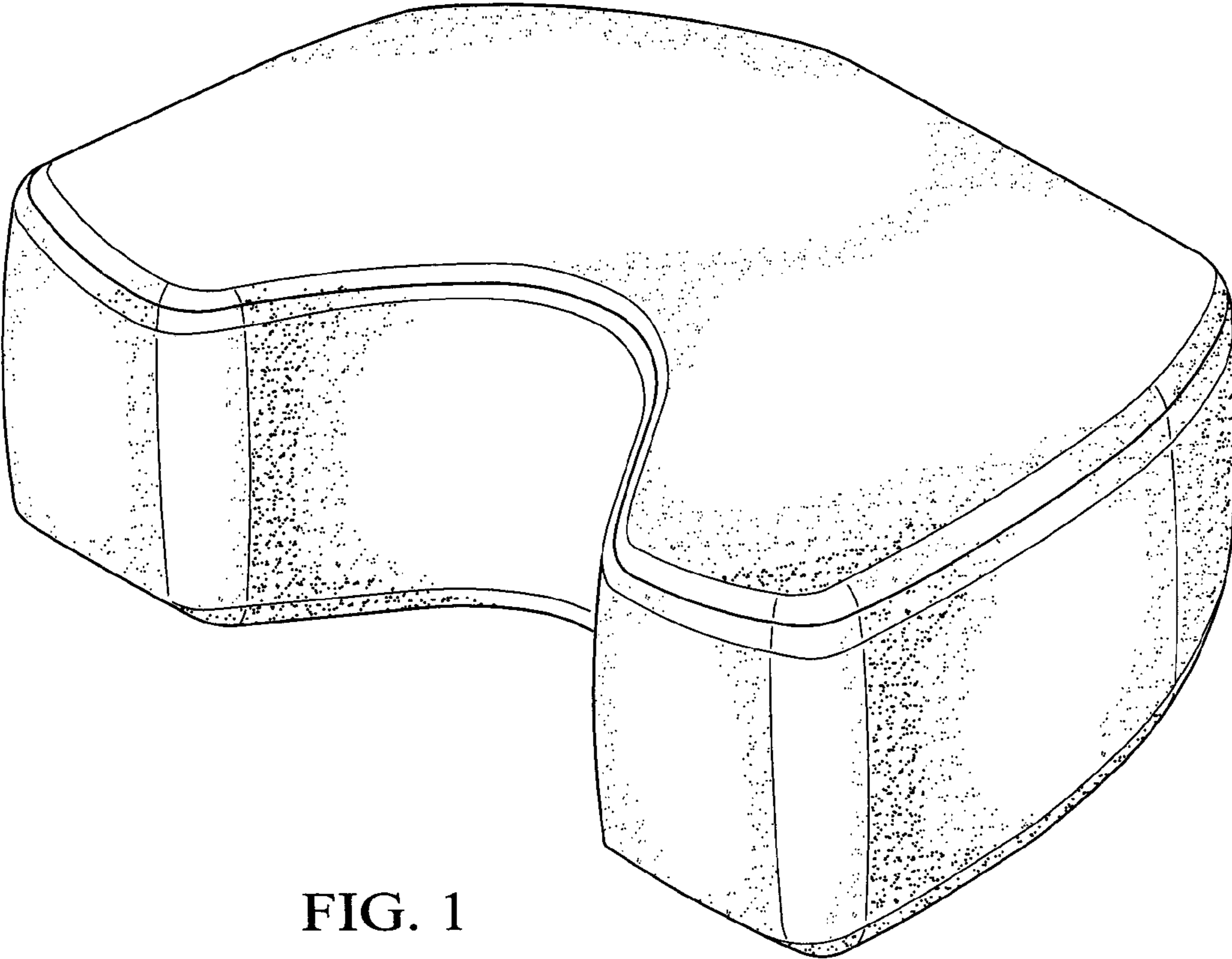

FIG. 1

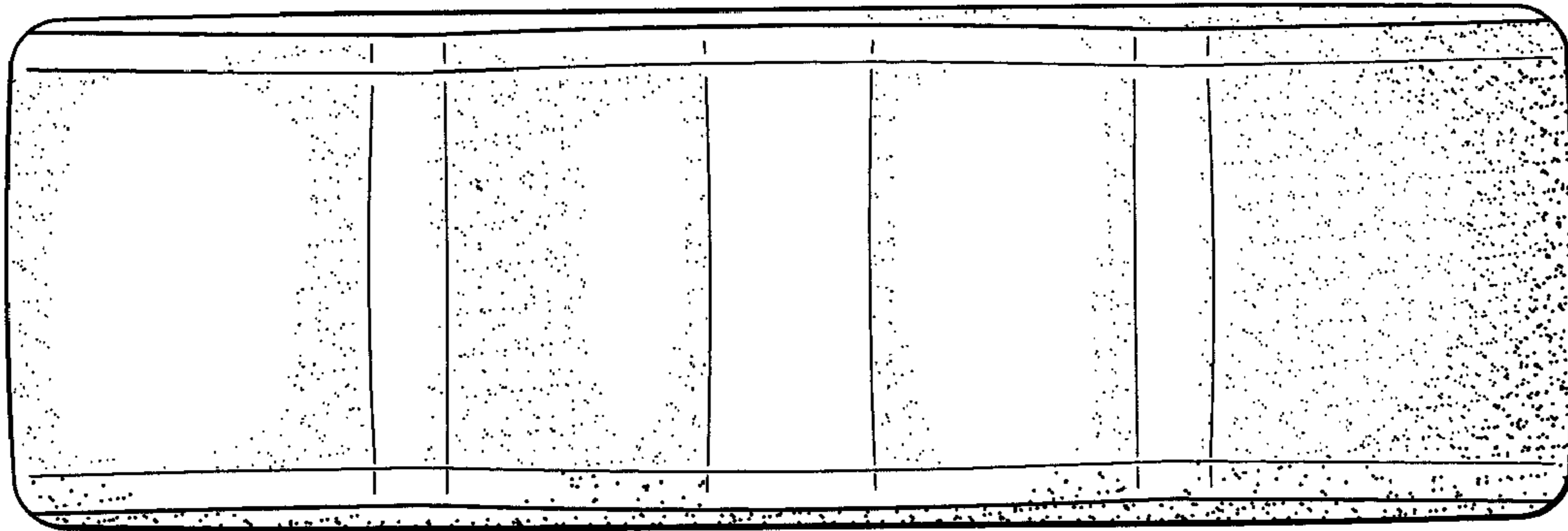

FIG. 2

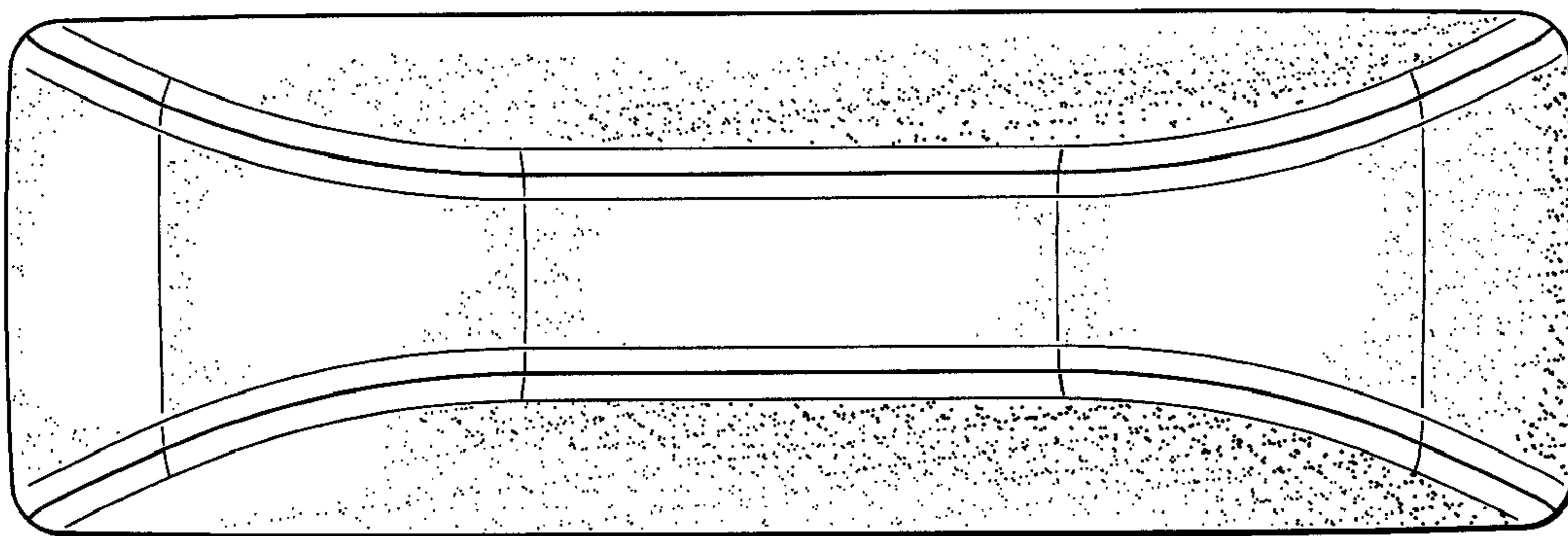

FIG. 3

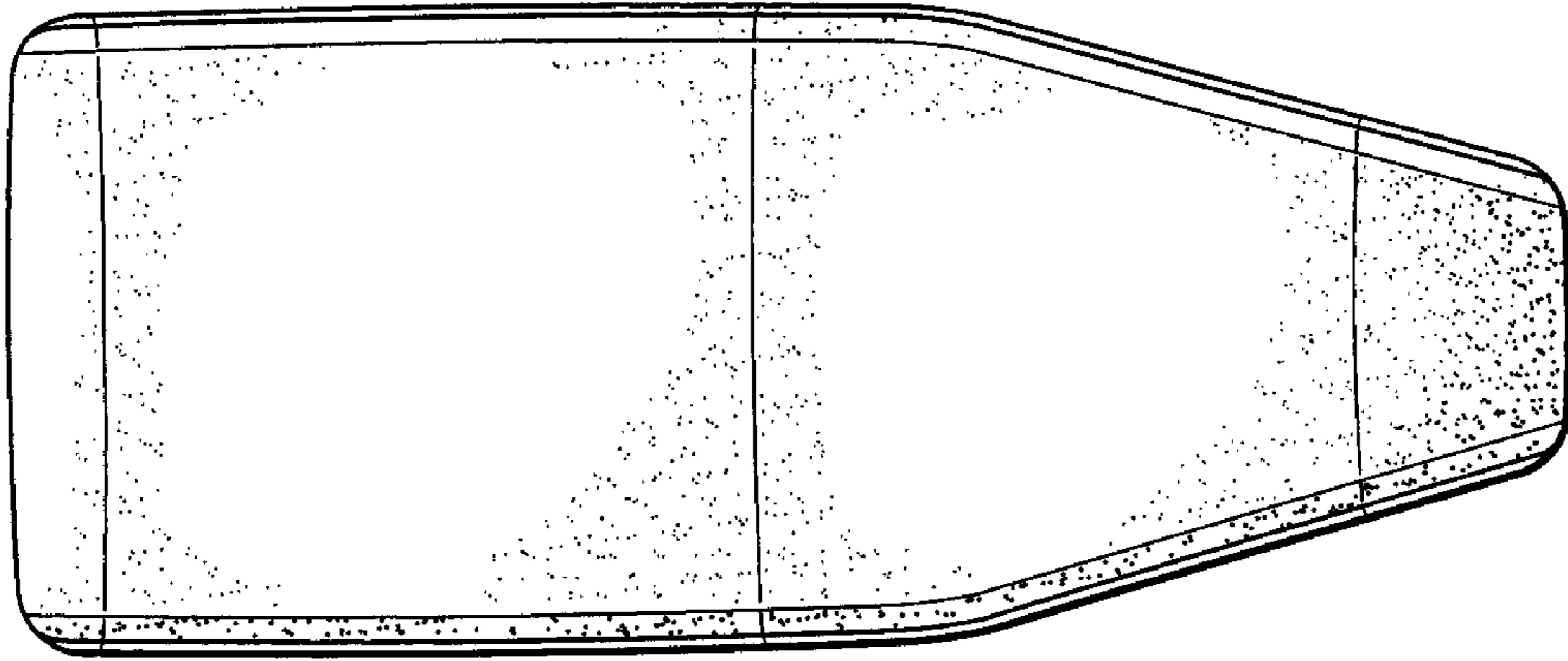

FIG. 4

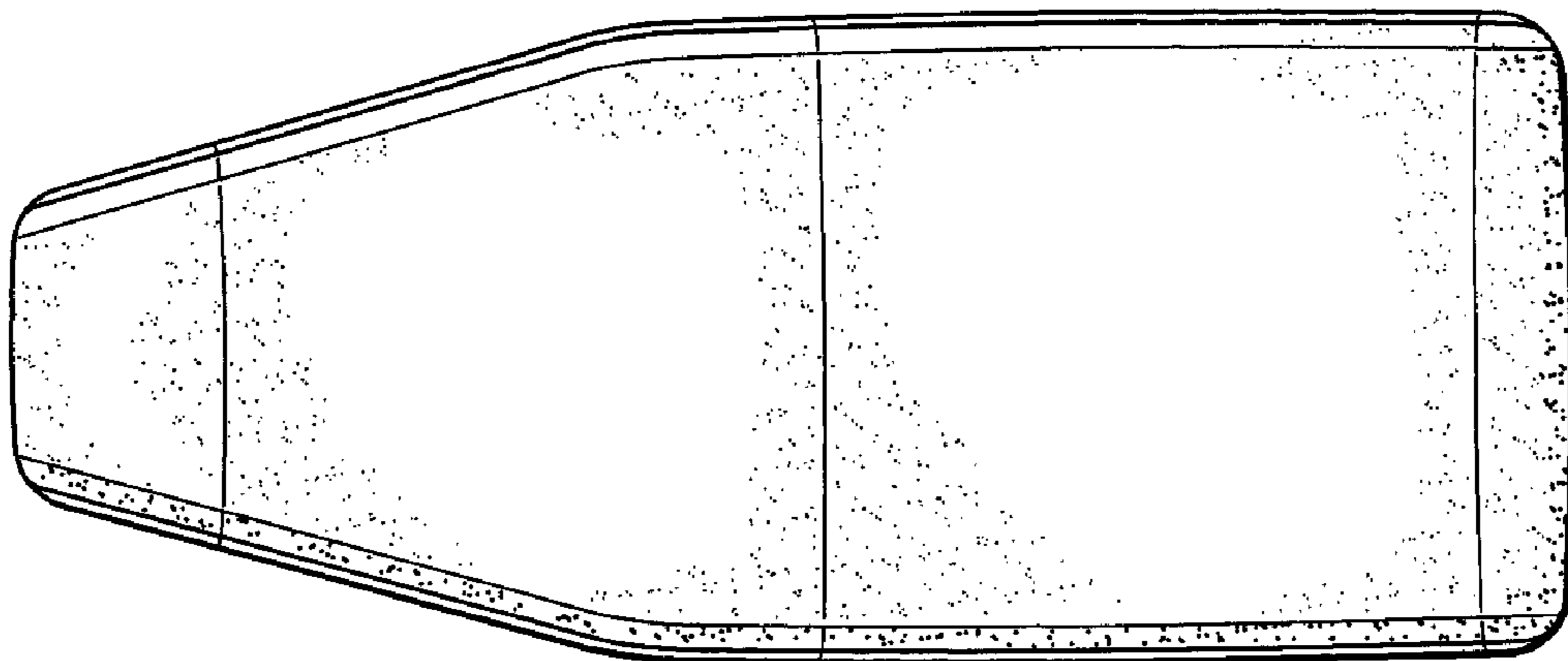

FIG. 5

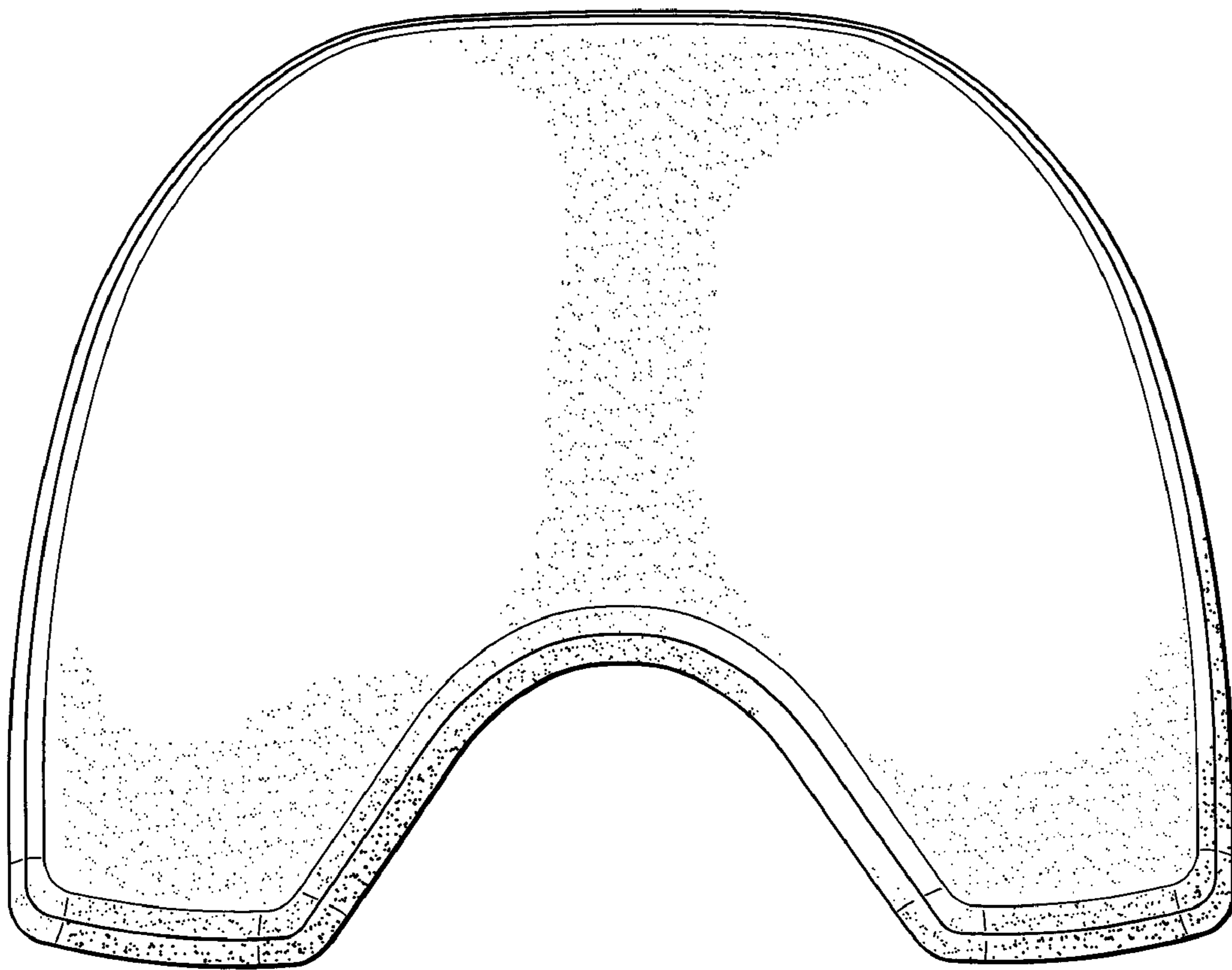

FIG. 6

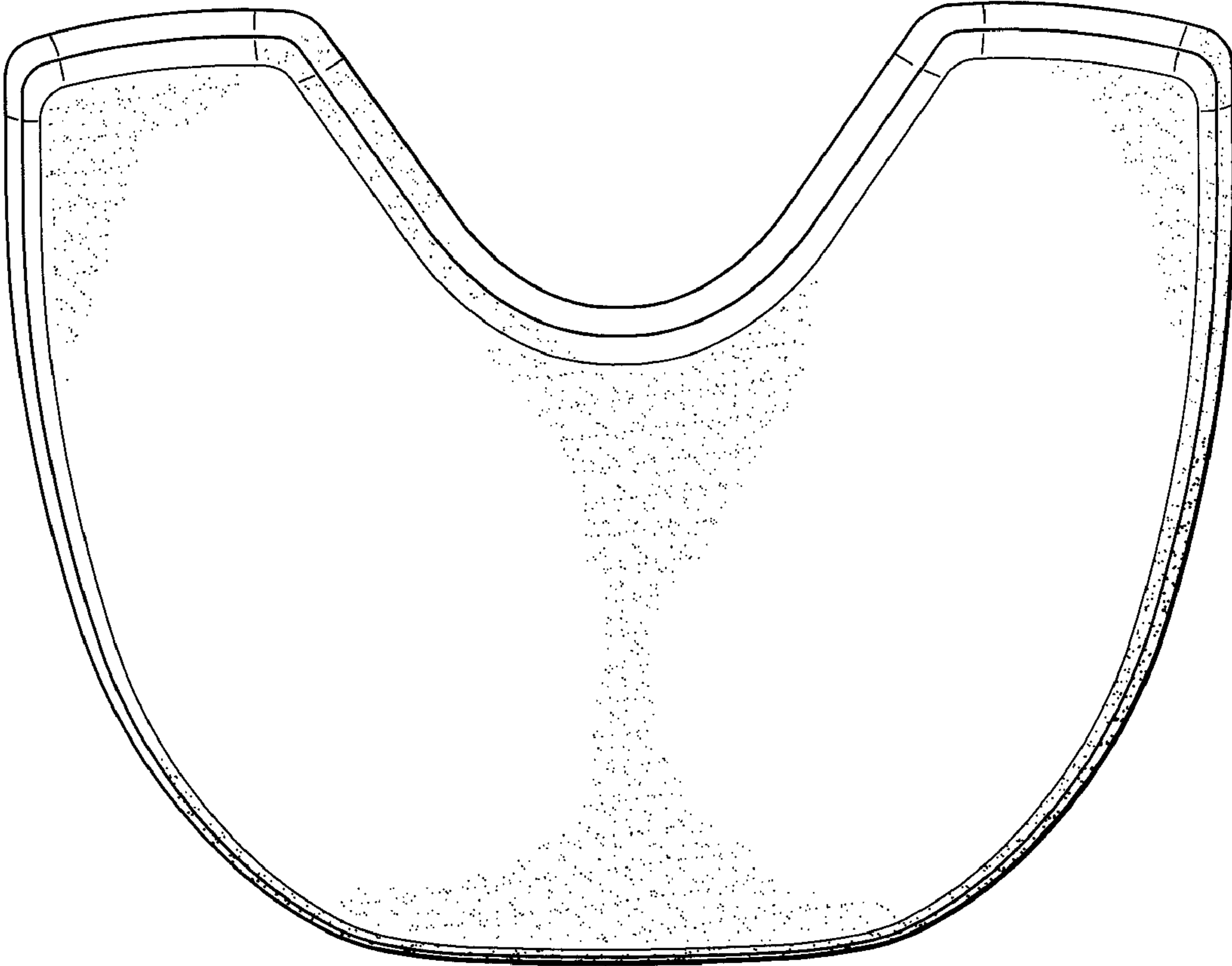

FIG. 7

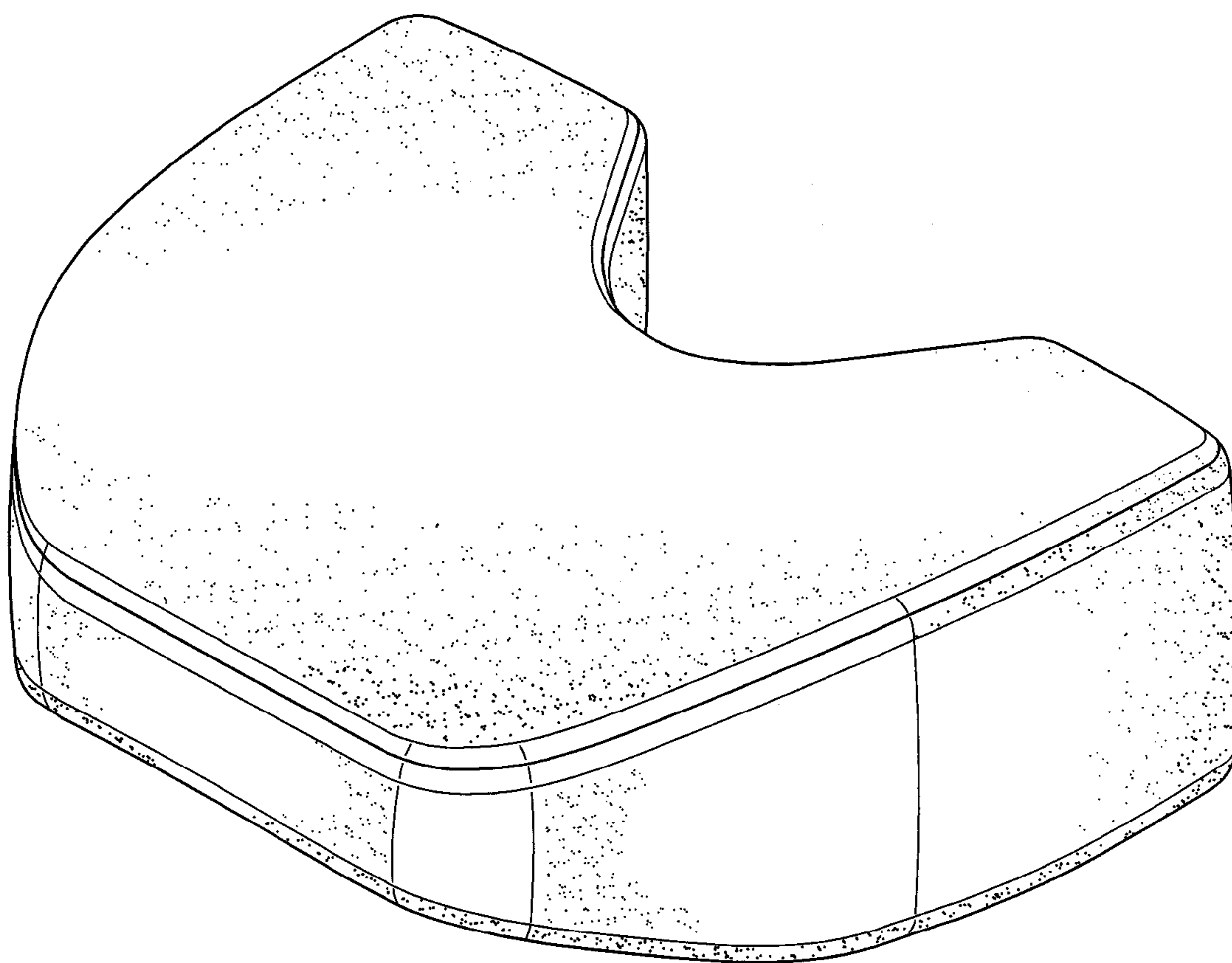

FIG. 8



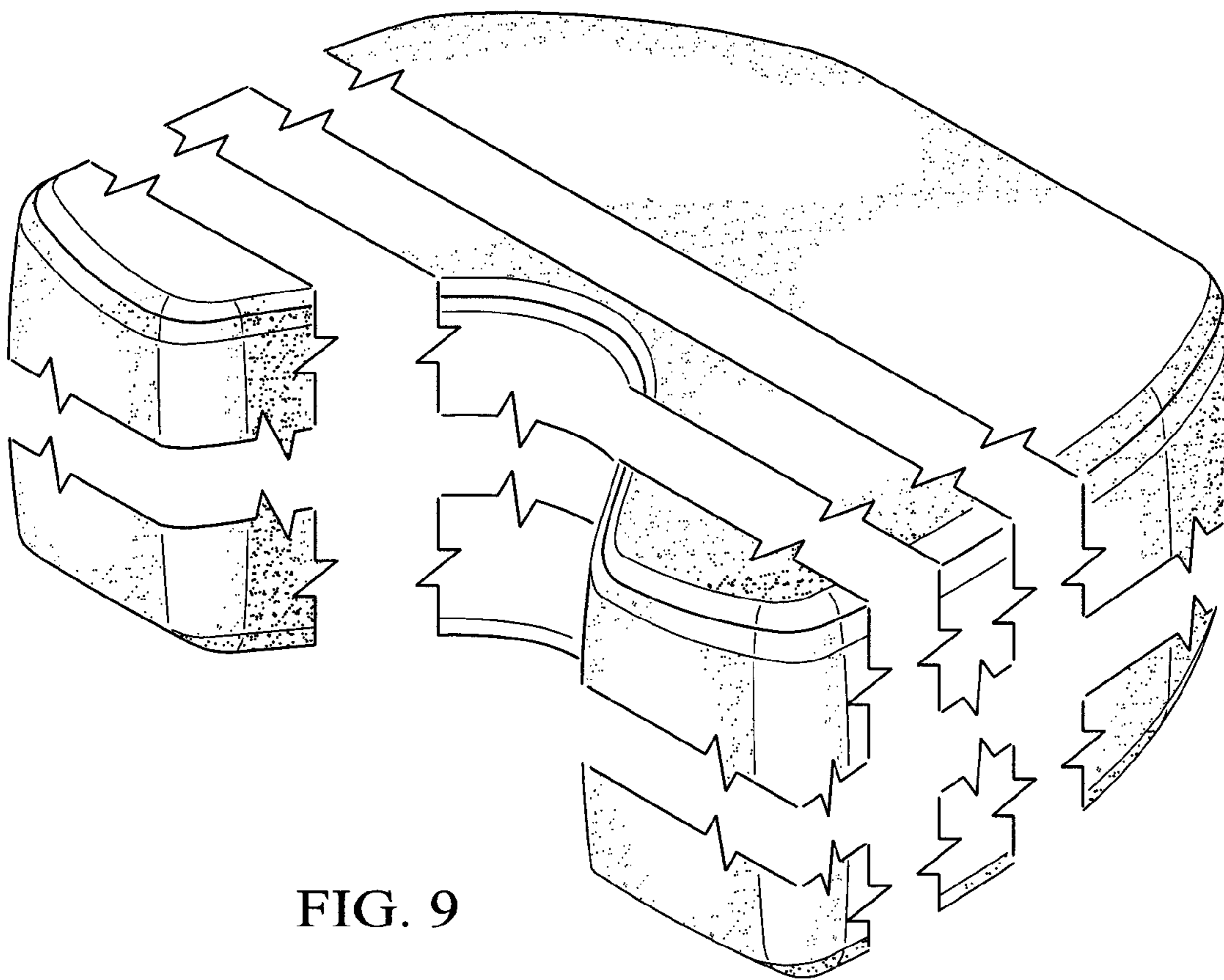

FIG. 9

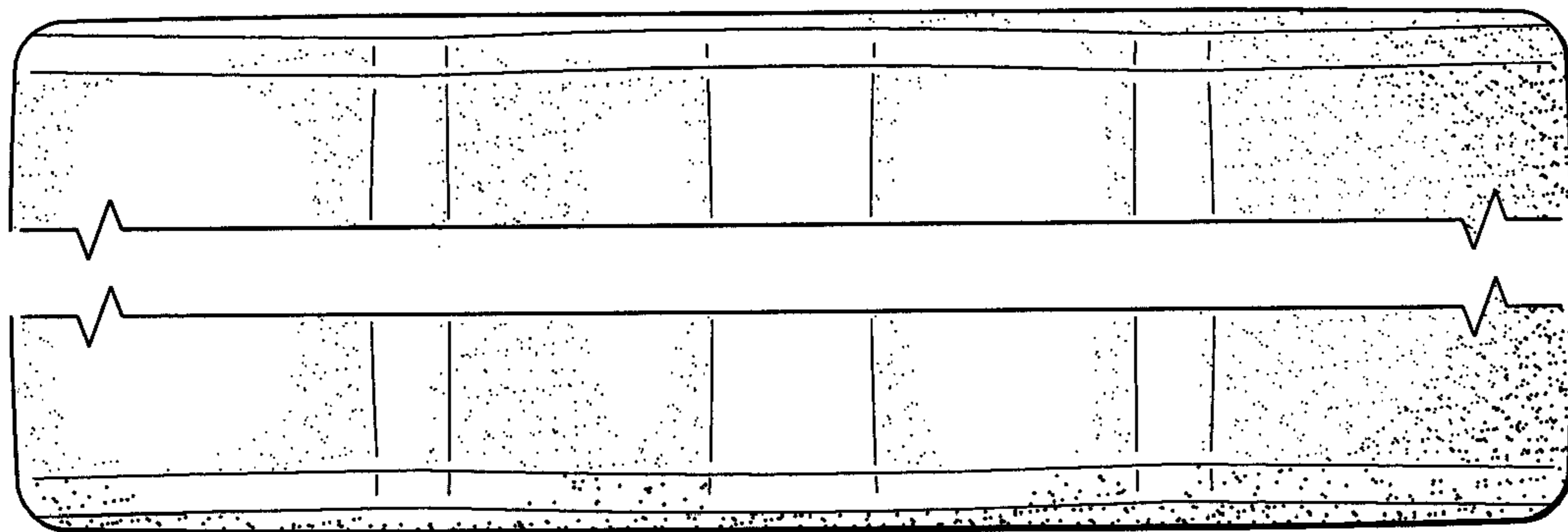

FIG. 10

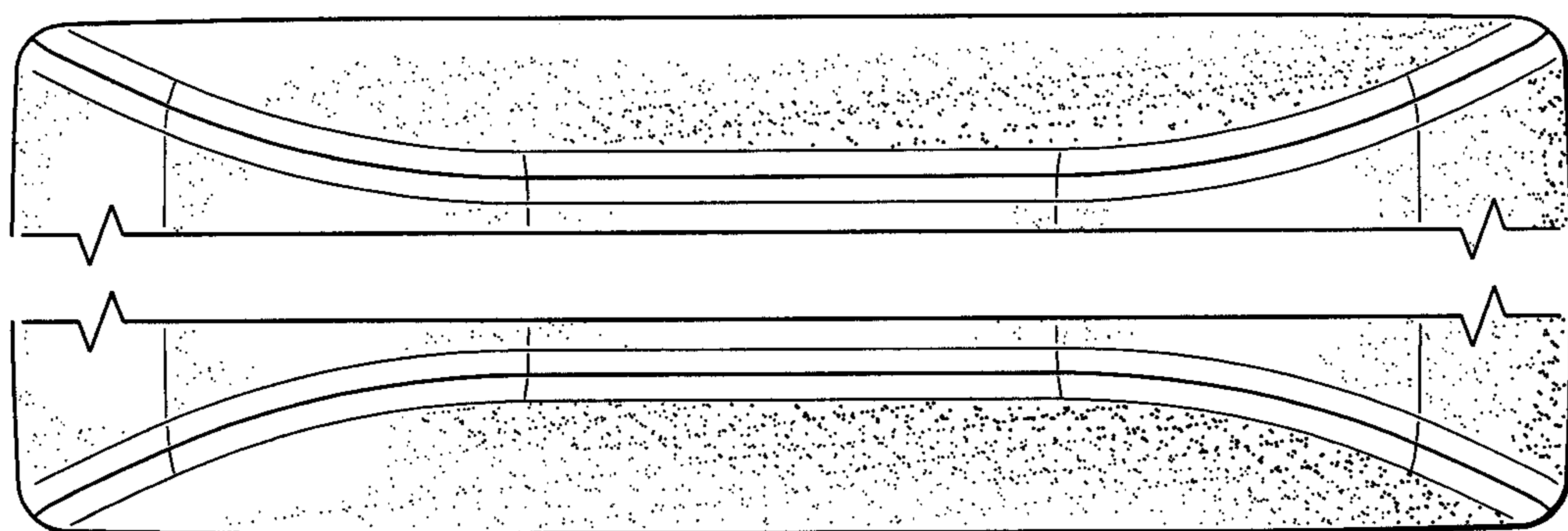

FIG. 11

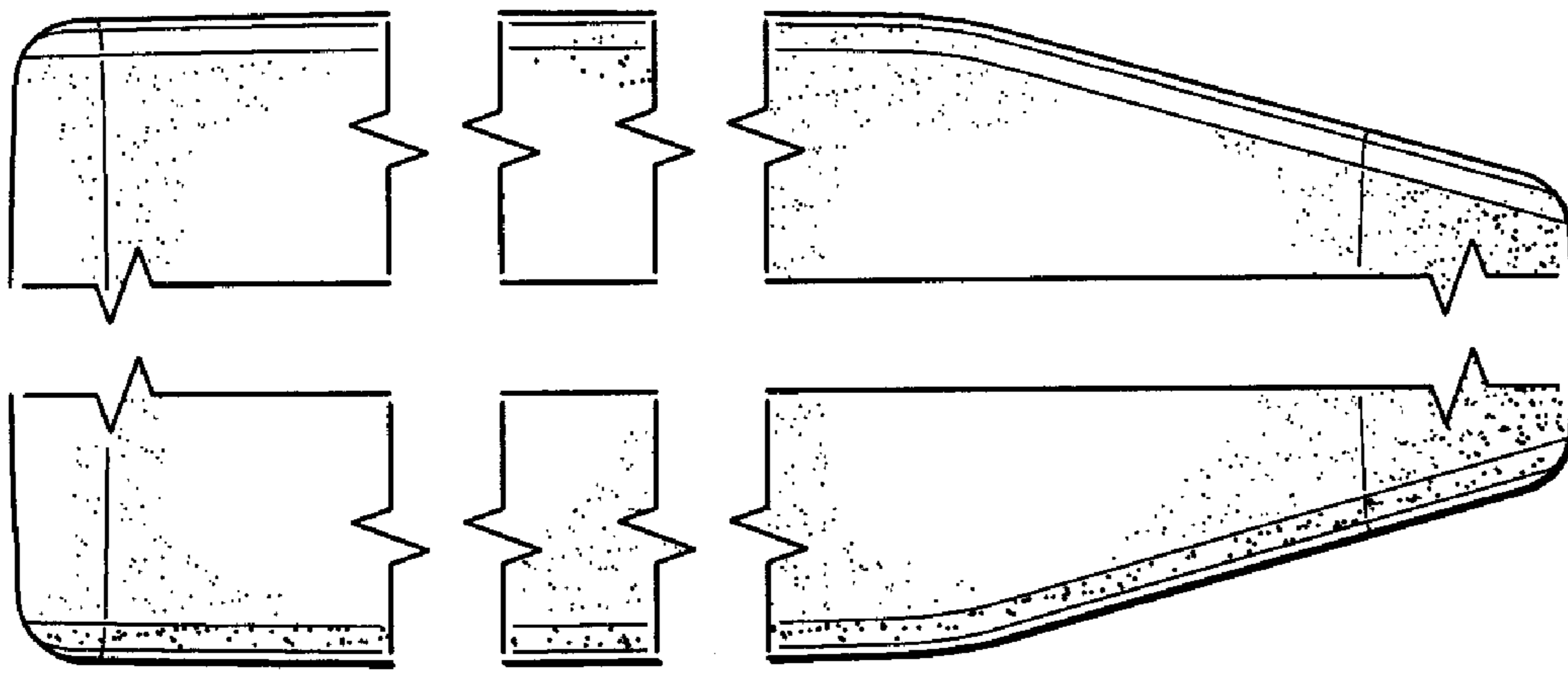

FIG. 12

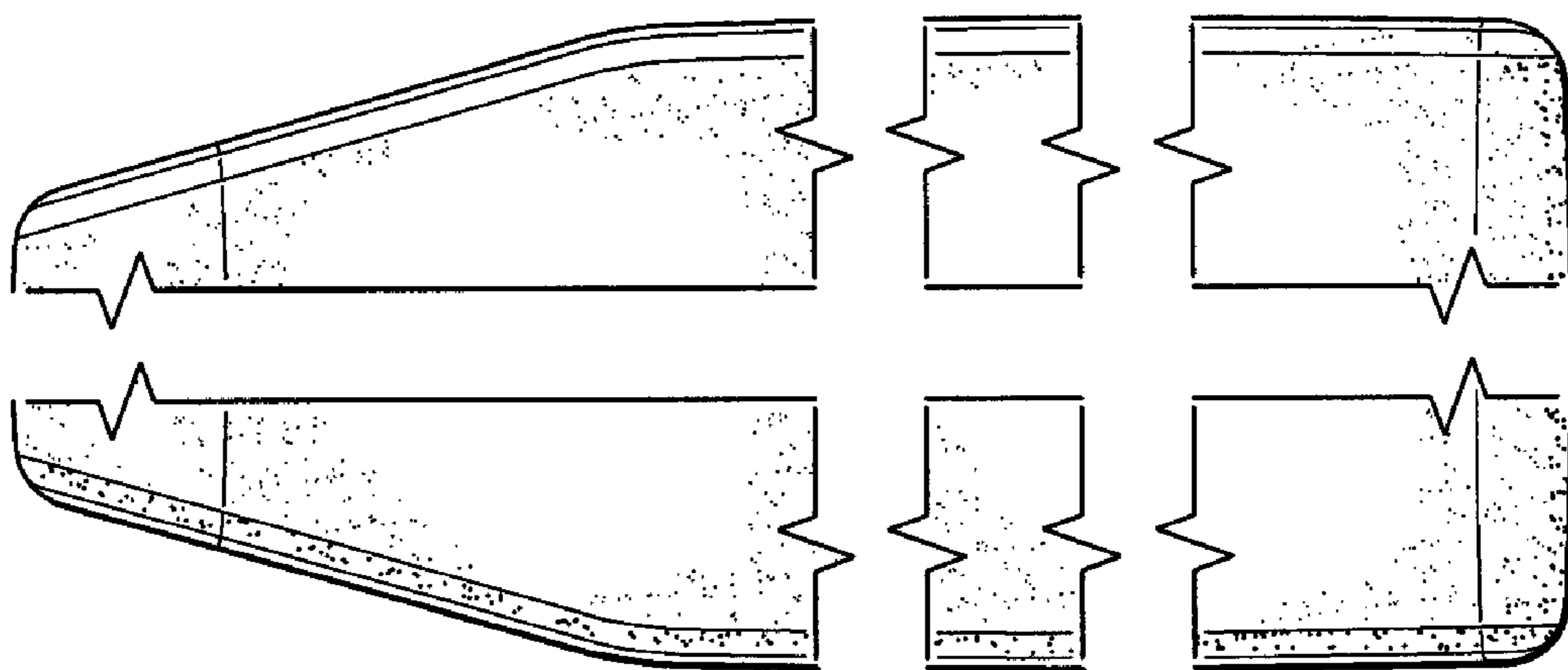

FIG. 13

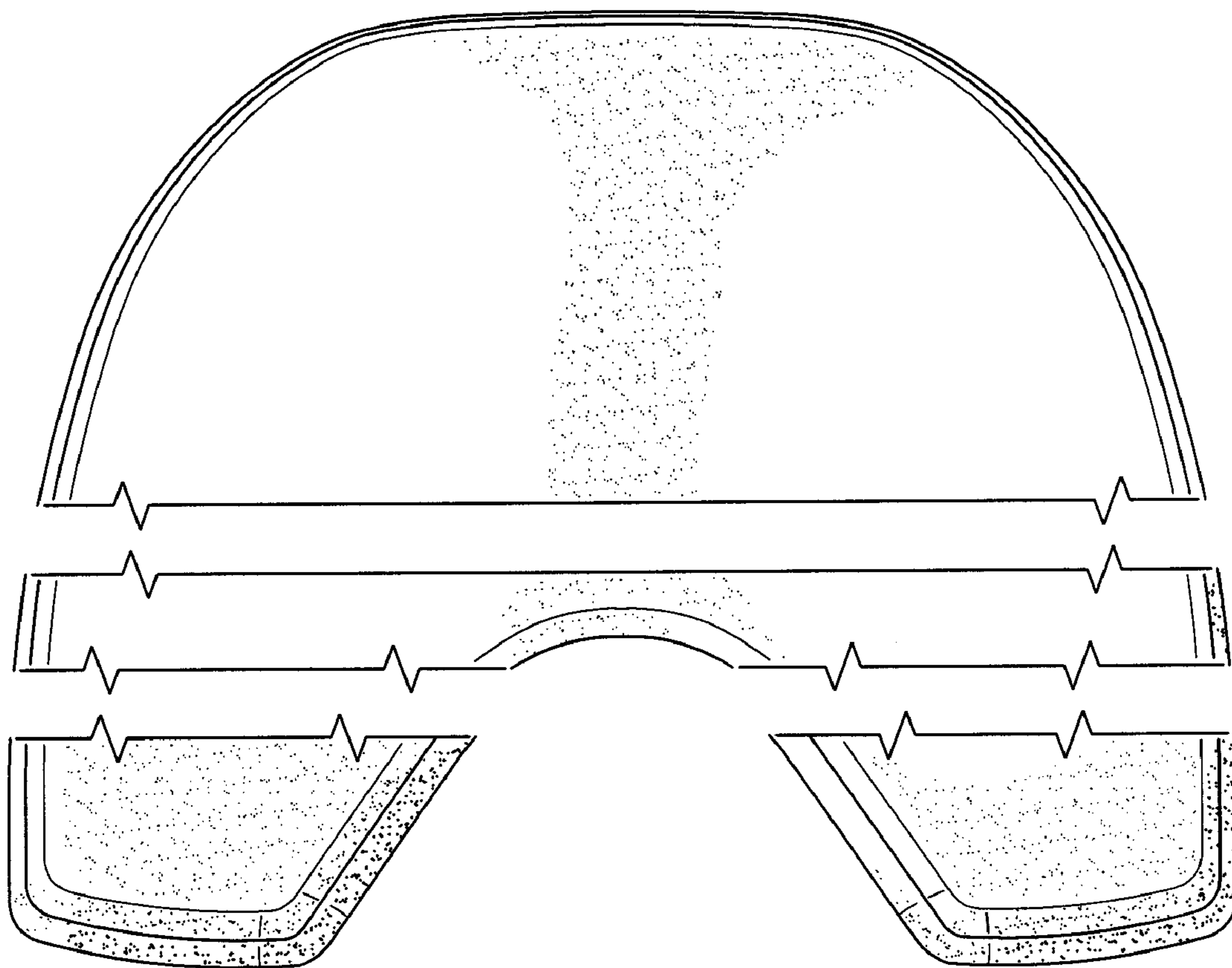

FIG. 14

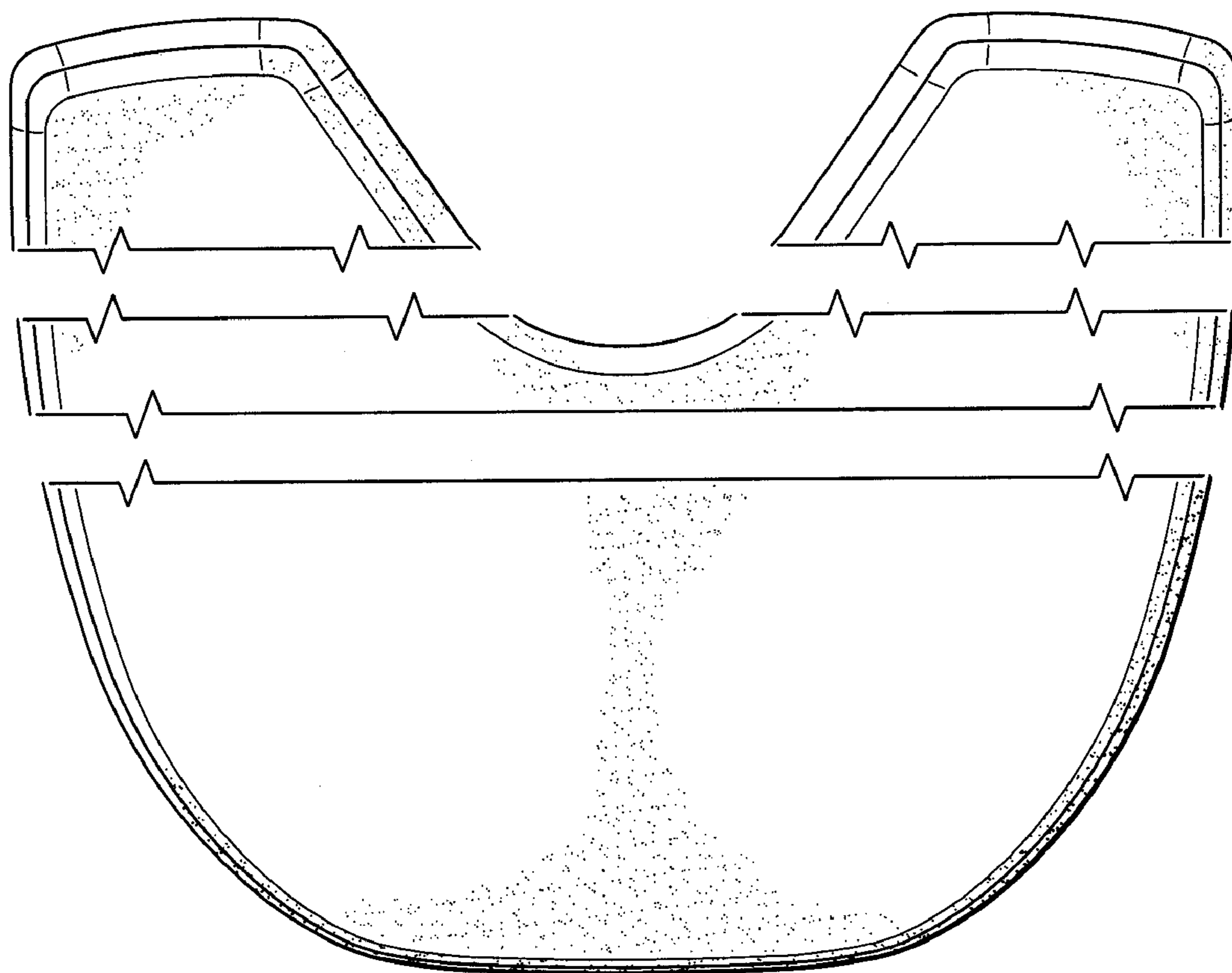

FIG. 15

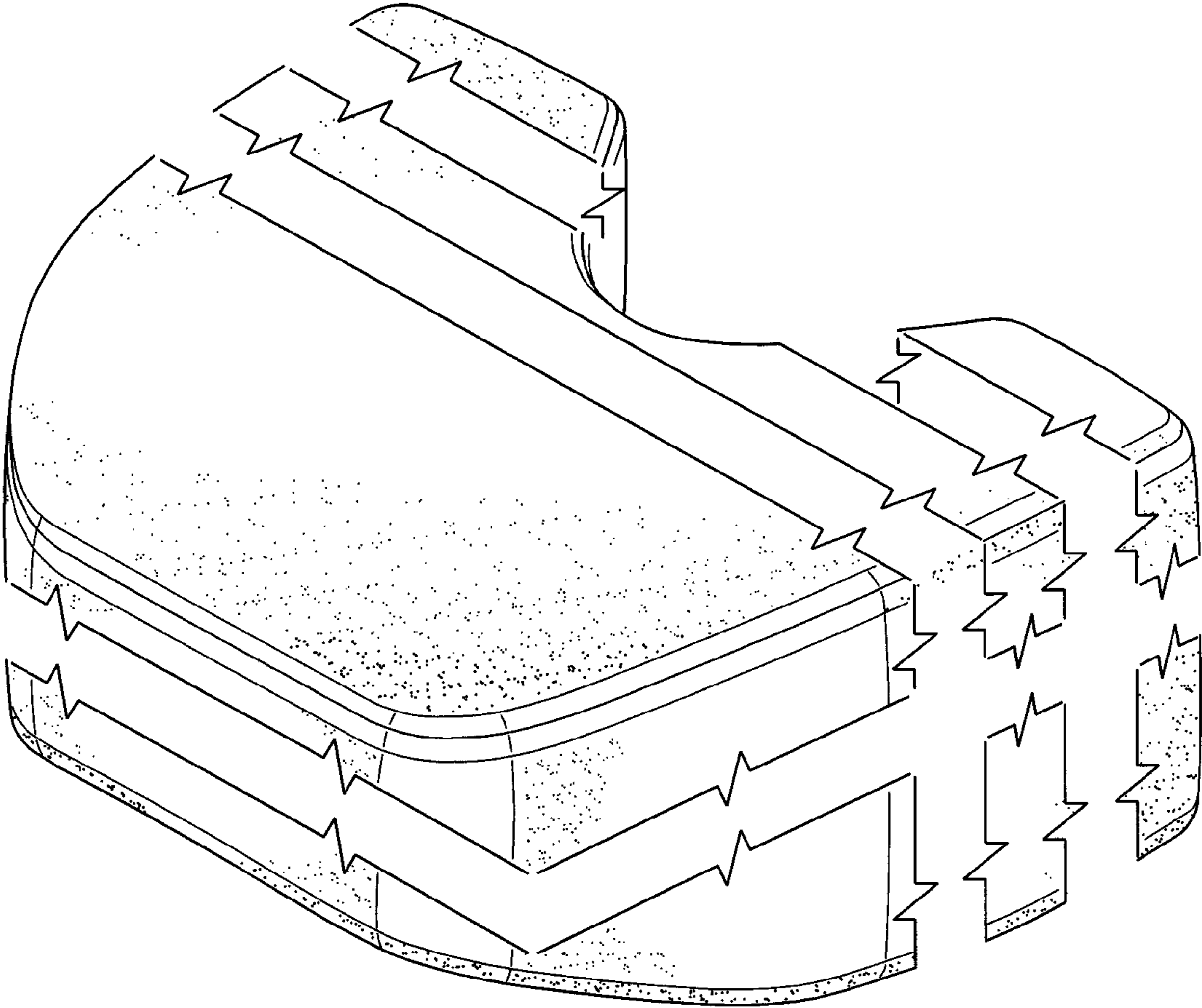

FIG. 16