



US00D637321S

(12) **United States Design Patent**
Yang

(10) **Patent No.:** **US D637,321 S**

(45) **Date of Patent:** **** May 3, 2011**

(54) **AUTOMOTIVE LAMP**

D560,291 S * 1/2008 Koyama D26/28
D561,358 S * 2/2008 Tachibana D26/28

(76) **Inventor:** **Hsiu-Pen Yang**, Taipei (TW)

* cited by examiner

(**) **Term:** **14 Years**

Primary Examiner — Marcus Jackson

(21) **Appl. No.:** **29/370,652**

(74) *Attorney, Agent, or Firm* — Charles R. Sutton; Law
Offices of Roger C. Hsu

(22) **Filed:** **Aug. 18, 2010**

(57) **CLAIM**

The ornamental design for an automotive lamp, as shown and
described.

(51) **LOC (9) Cl.** **26-06**

DESCRIPTION

(52) **U.S. Cl.** **D26/28**

(58) **Field of Classification Search** D26/28-36;
362/459-468, 475-478, 485-487

FIG. 1 is a perspective view of an automotive lamp showing
my new design;

See application file for complete search history.

FIG. 2 is a front elevational view thereof;
FIG. 3 is a rear elevational view thereof;
FIG. 4 is a left side elevational view thereof;
FIG. 5 is a right side elevational view thereof;
FIG. 6 is a top plan view thereof; and,
FIG. 7 is a bottom plan view thereof.

(56) **References Cited**

U.S. PATENT DOCUMENTS

D550,383 S * 9/2007 Asai D26/28
D556,349 S * 11/2007 Golden et al. D26/28

1 Claim, 7 Drawing Sheets

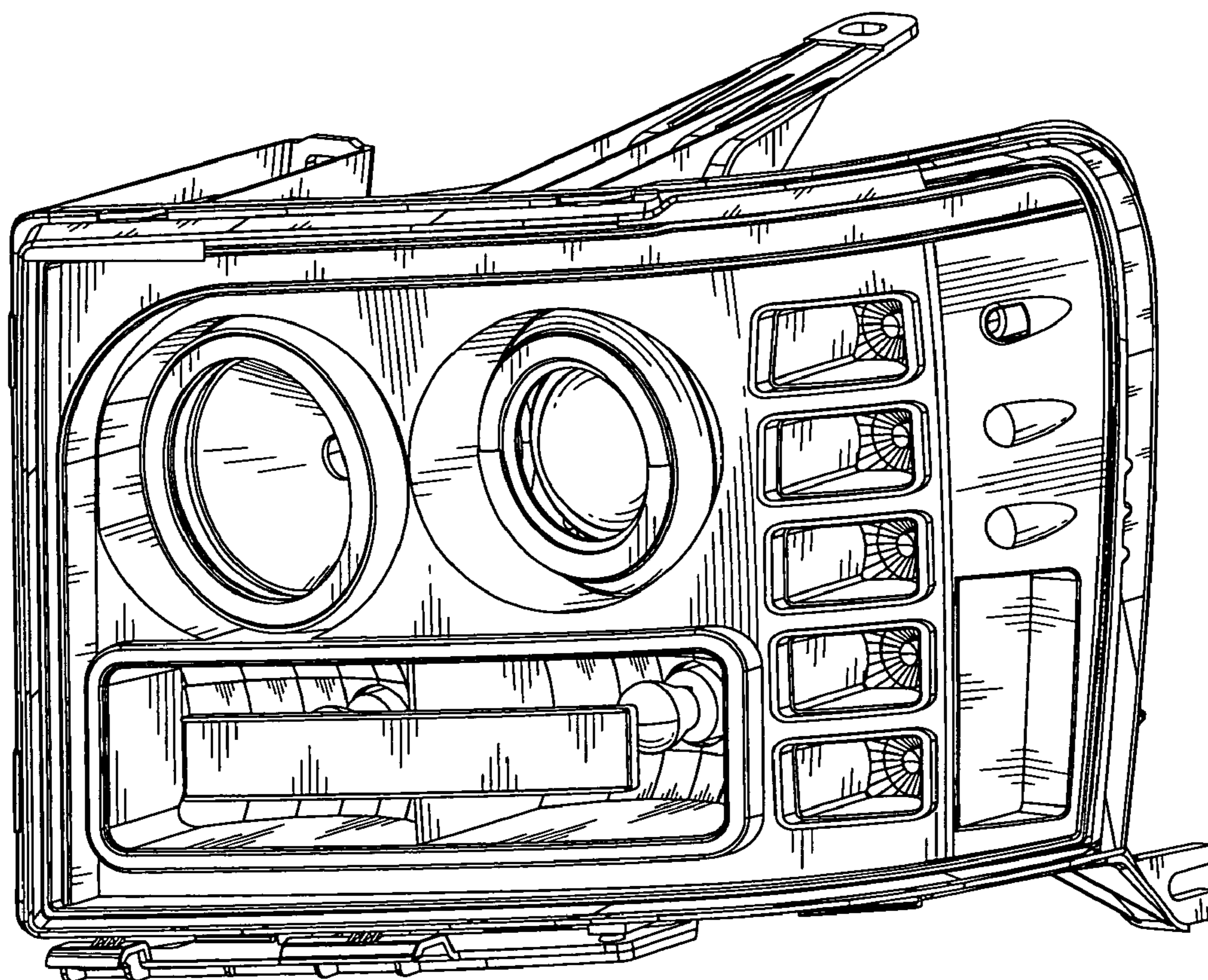

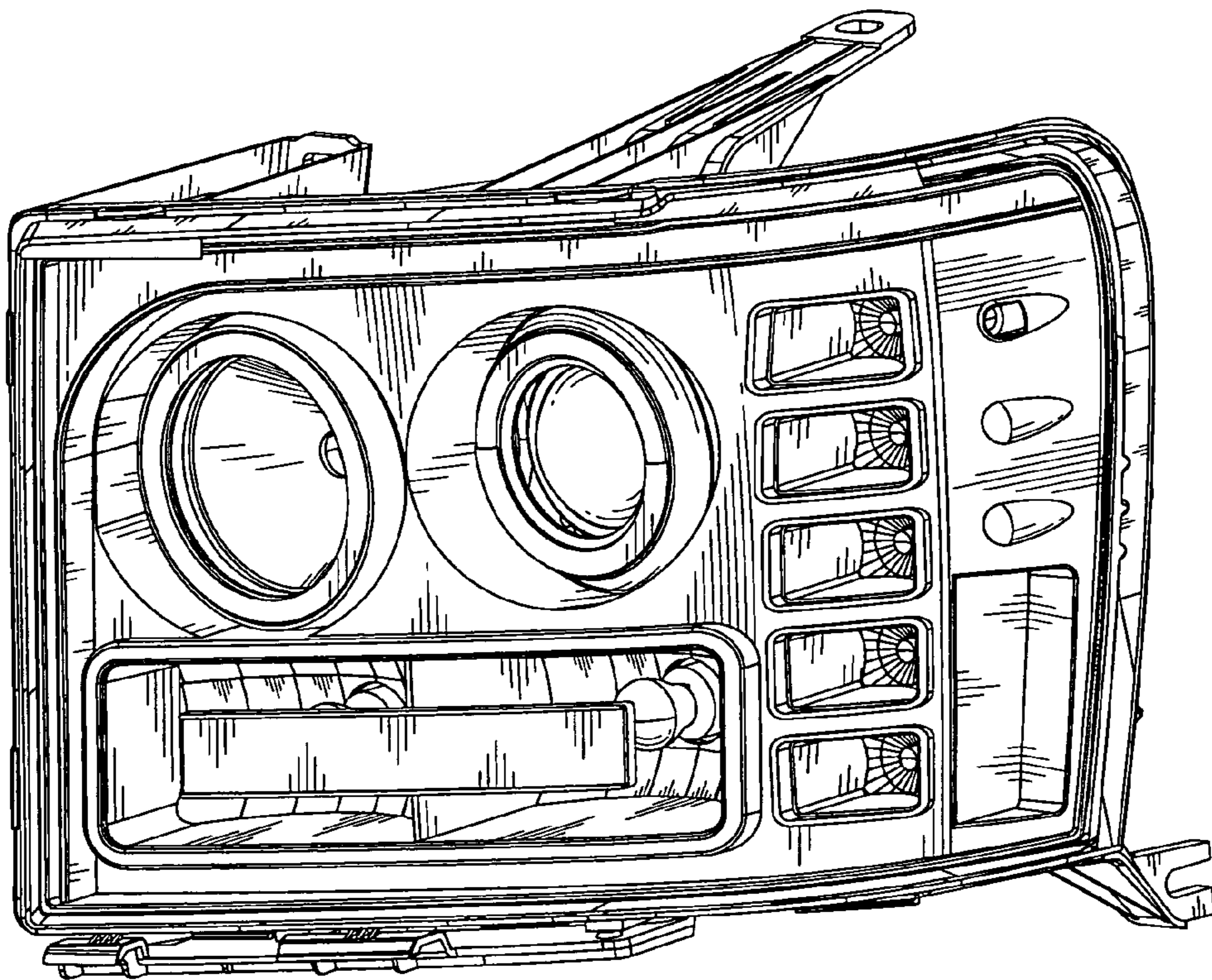

FIG. 1

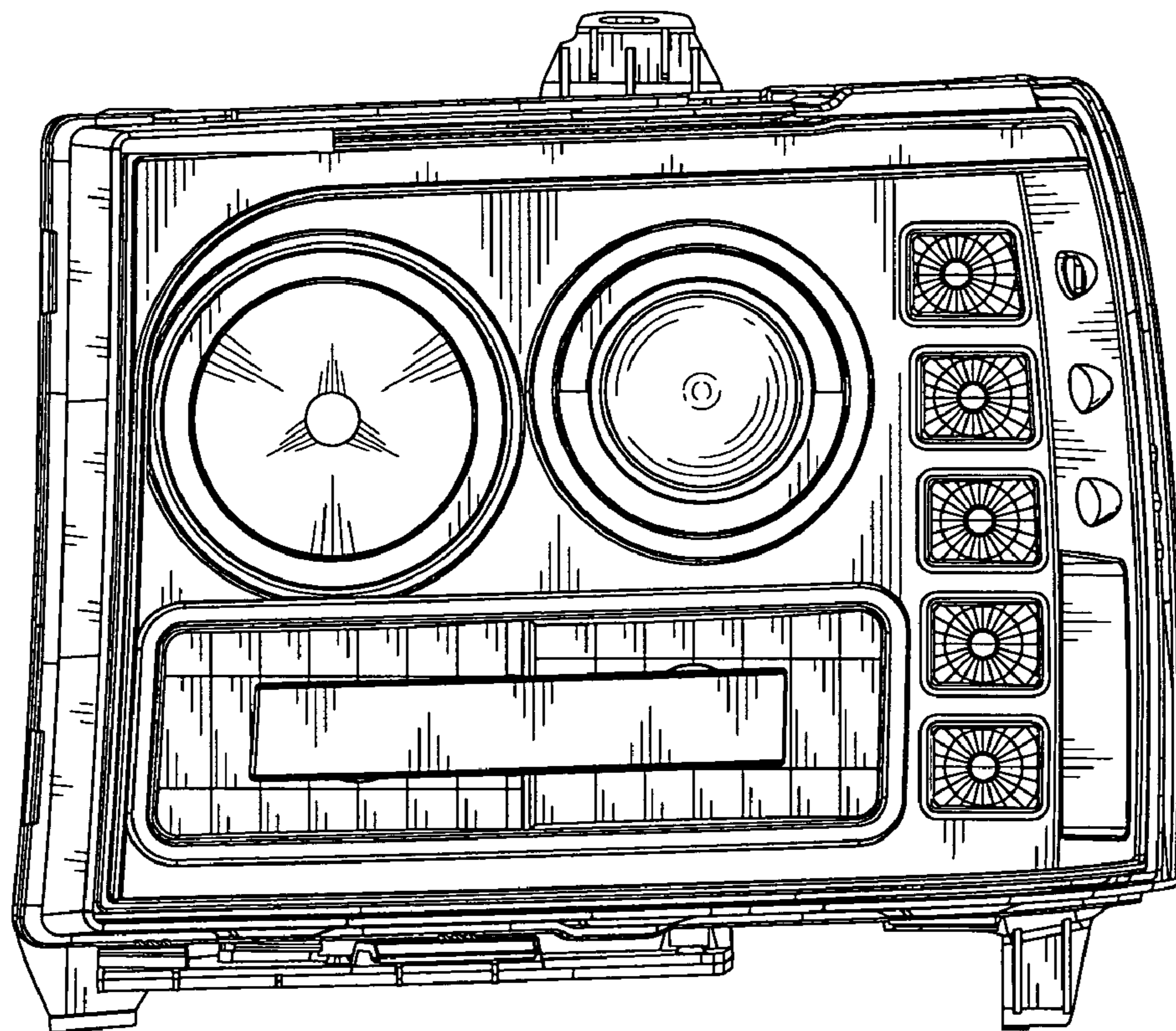

FIG. 2

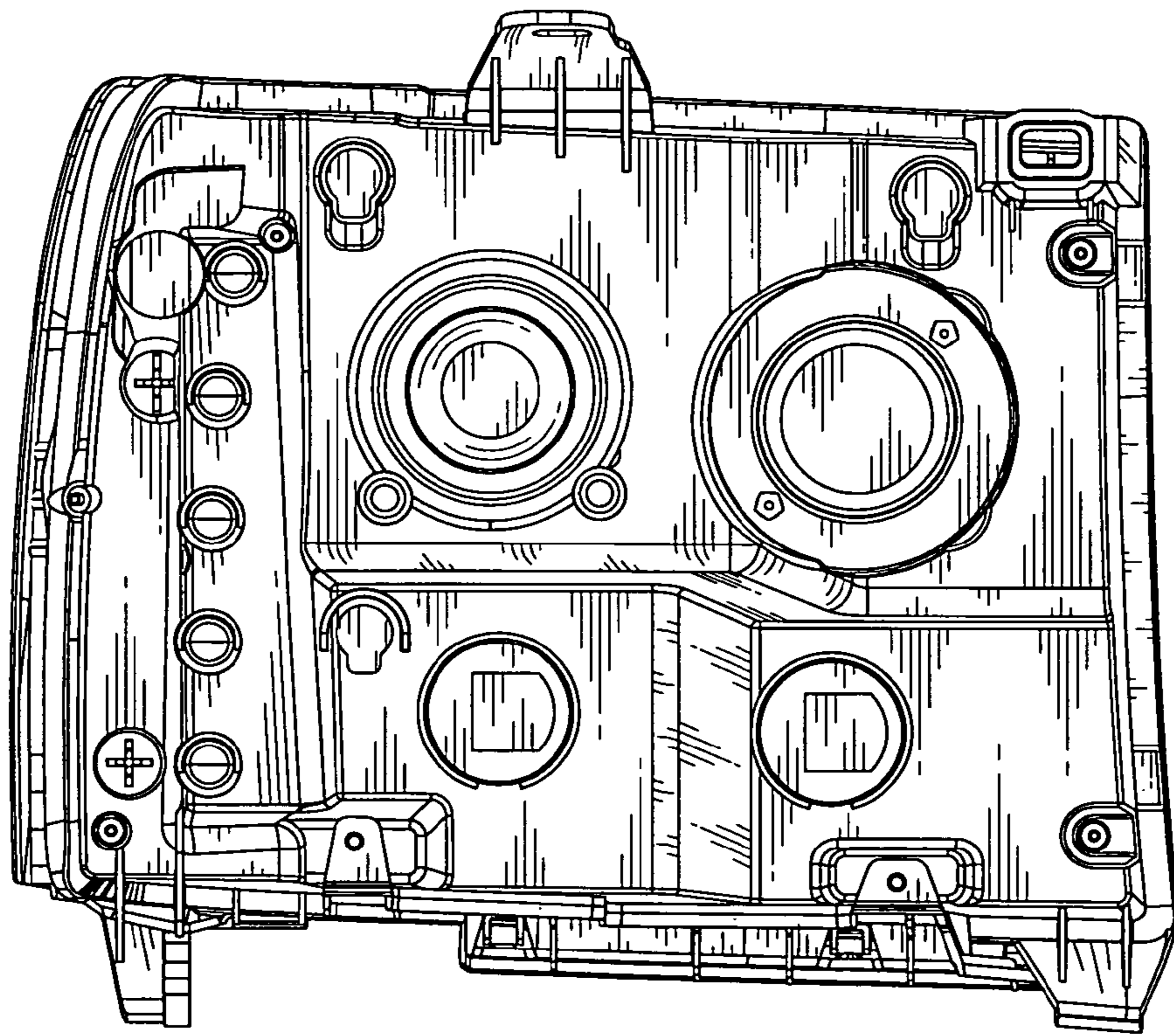

FIG. 3

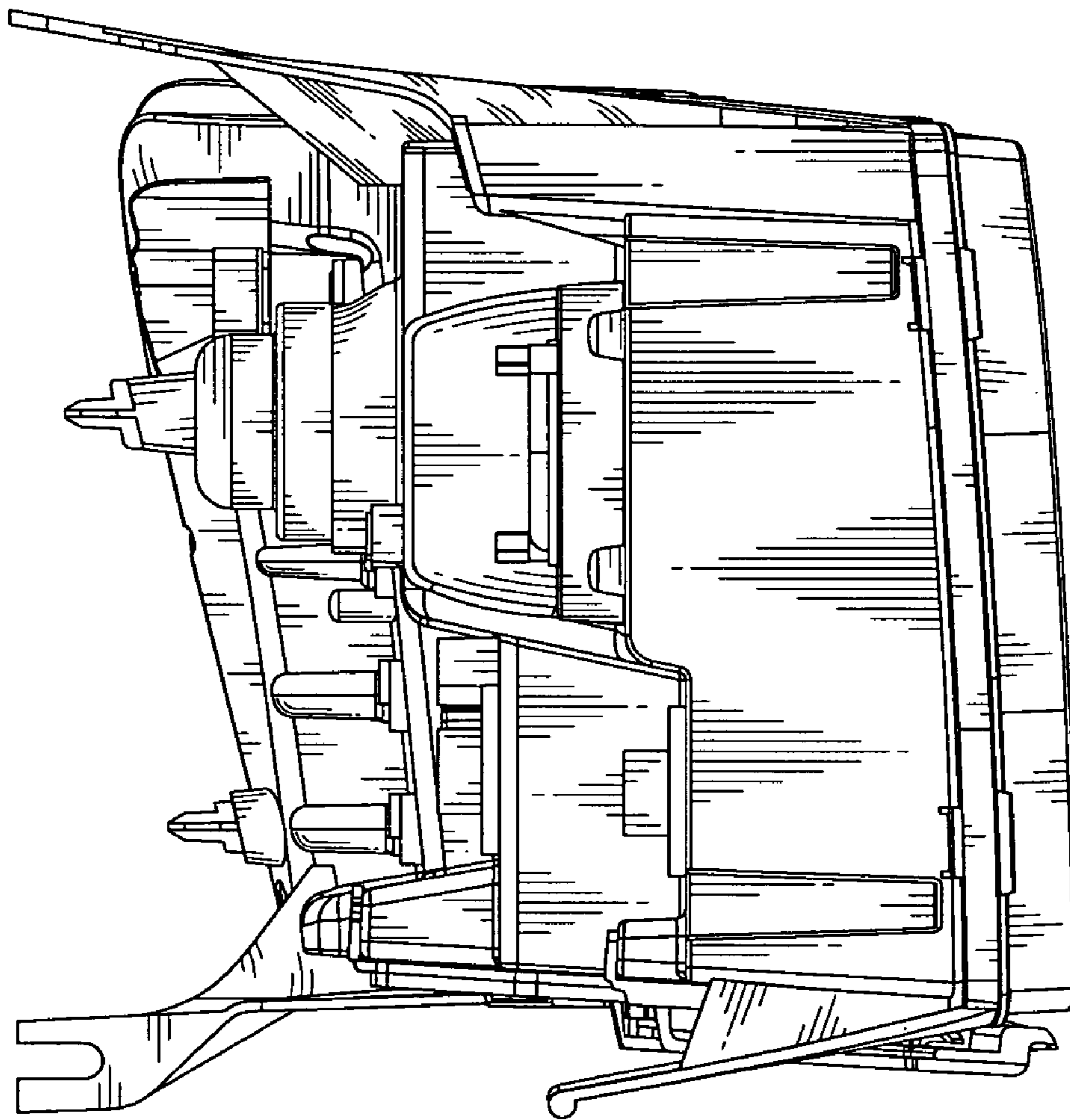

FIG. 4

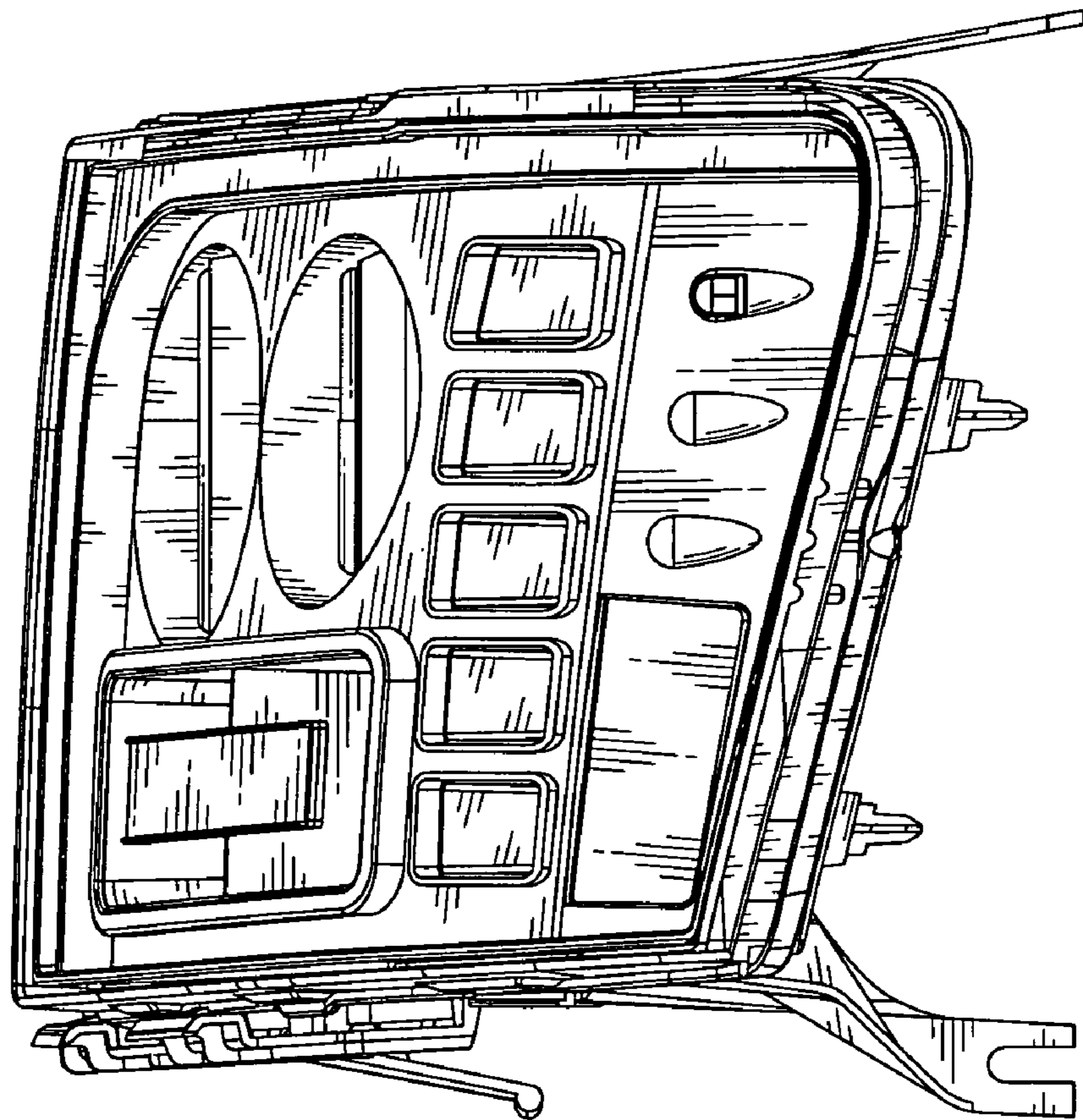

FIG. 5

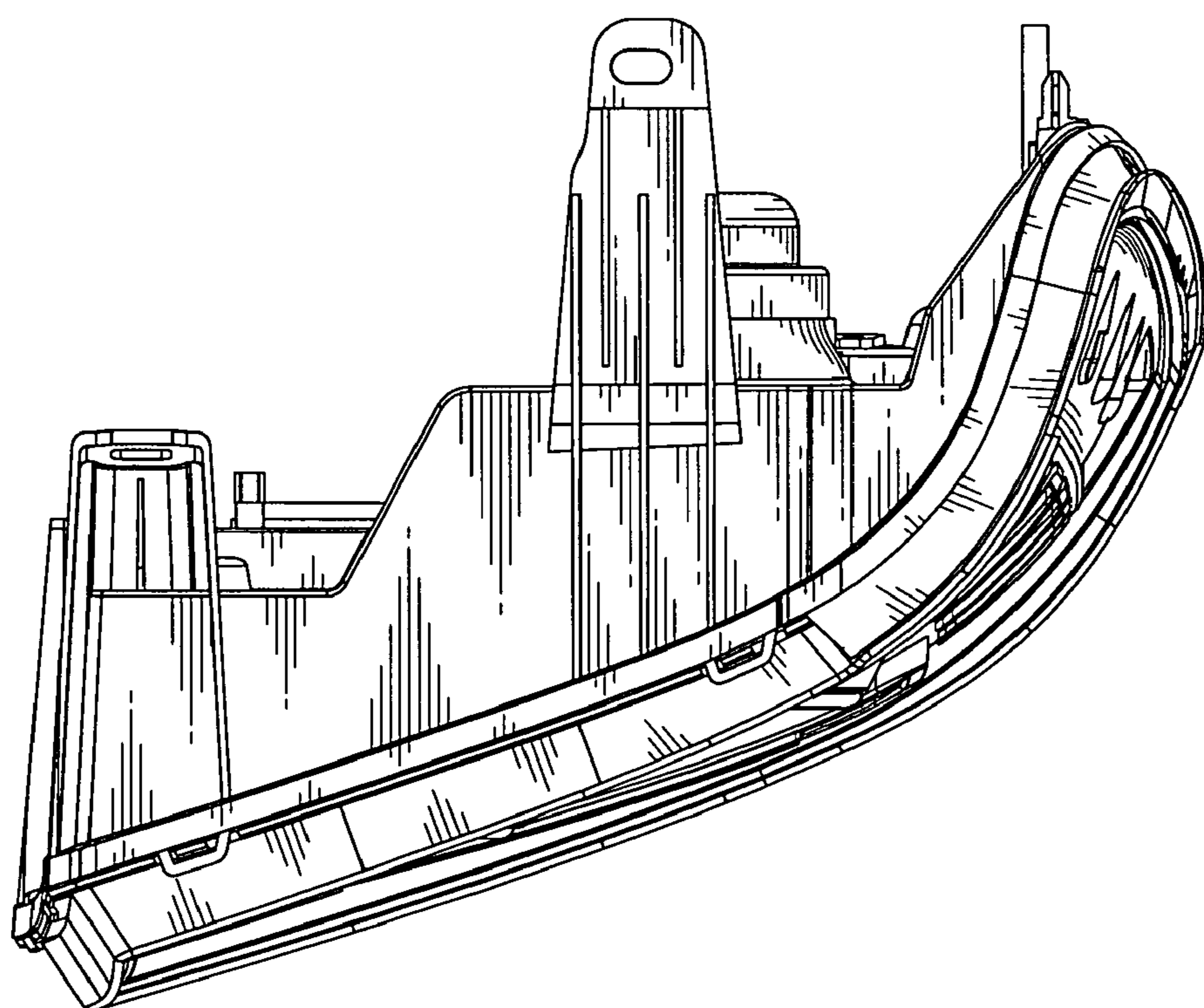

FIG. 6

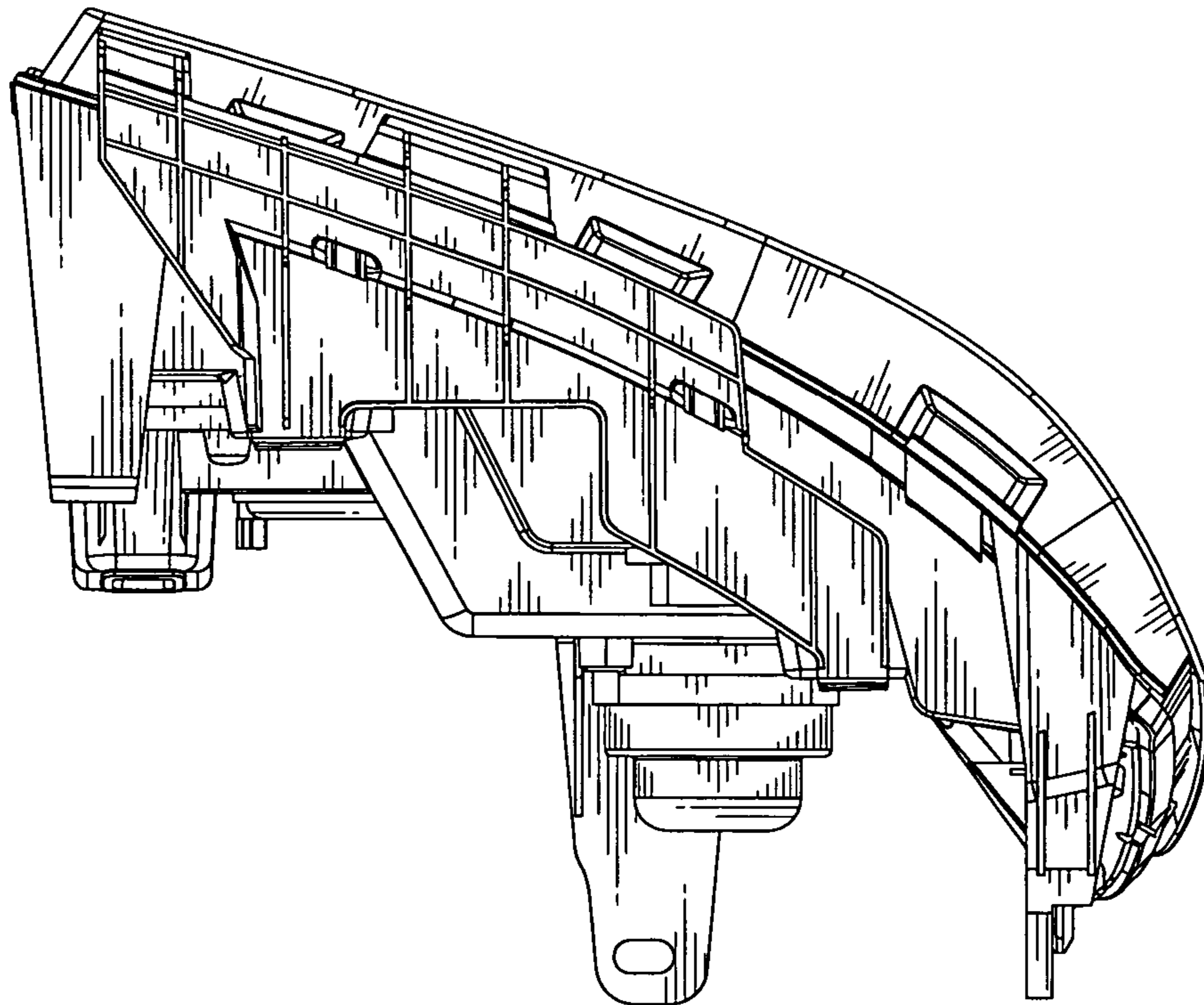

FIG. 7