



US00D637285S

(12) **United States Design Patent**
Bradley et al.

(10) **Patent No.:** **US D637,285 S**

(45) **Date of Patent:** **** May 3, 2011**

(54) **NASAL ORAL CANNULA**

(75) **Inventors:** **Donald Carmon Bradley**, Kanata (CA);
Stephen Keir Roberts, Ottawa, CA
(US); **Richard Anthony Bonato**, Carp
(CA)

(73) **Assignee:** **Braebon Medical Corporation**, Kanata
(CA)

(**) **Term:** **14 Years**

(21) **Appl. No.:** **29/250,391**

(22) **Filed:** **Nov. 13, 2006**

(51) **LOC (9) Cl.** **29-02**

(52) **U.S. Cl.** **D24/110.5**

(58) **Field of Classification Search** D24/110,
D24/110.5, 110.6; 425/275; 128/200.26,
128/204.23, 207.18, 207.13, 206.16, 911,
128/206.11; 600/529, 364

See application file for complete search history.

(56) **References Cited**

U.S. PATENT DOCUMENTS

4,263,908	A *	4/1981	Mizerak	128/205.25
D262,322	S	12/1981	Mizerak		
4,367,735	A *	1/1983	Dali	128/207.18
5,046,491	A	9/1991	Derrick		

6,830,445	B2	12/2004	Curti		
D533,269	S *	12/2006	McAuley et al.	D24/110.6
7,337,780	B2 *	3/2008	Curti et al.	128/207.18
7,353,826	B2 *	4/2008	Sleeper et al.	128/206.11
2001/0031929	A1 *	10/2001	O'Toole	600/532
2006/0130840	A1 *	6/2006	Porat et al.	128/206.11

* cited by examiner

Primary Examiner — Ian Simmons

Assistant Examiner — Christopher Lee

(74) *Attorney, Agent, or Firm* — Mukundan Chakrapani;
Borden Ladner Gervais LLP

(57) **CLAIM**

The ornamental design for a nasal oral cannula, as shown and described.

DESCRIPTION

FIG. 1 is a front perspective view of the nasal oral cannula of the present invention;

FIG. 2 is a rear perspective view thereof;

FIG. 3 is a front view thereof;

FIG. 4 is a rear view thereof;

FIG. 5 is a side view thereof;

FIG. 6 is a bottom view thereof; and,

FIG. 7 is a top view thereof.

1 Claim, 7 Drawing Sheets

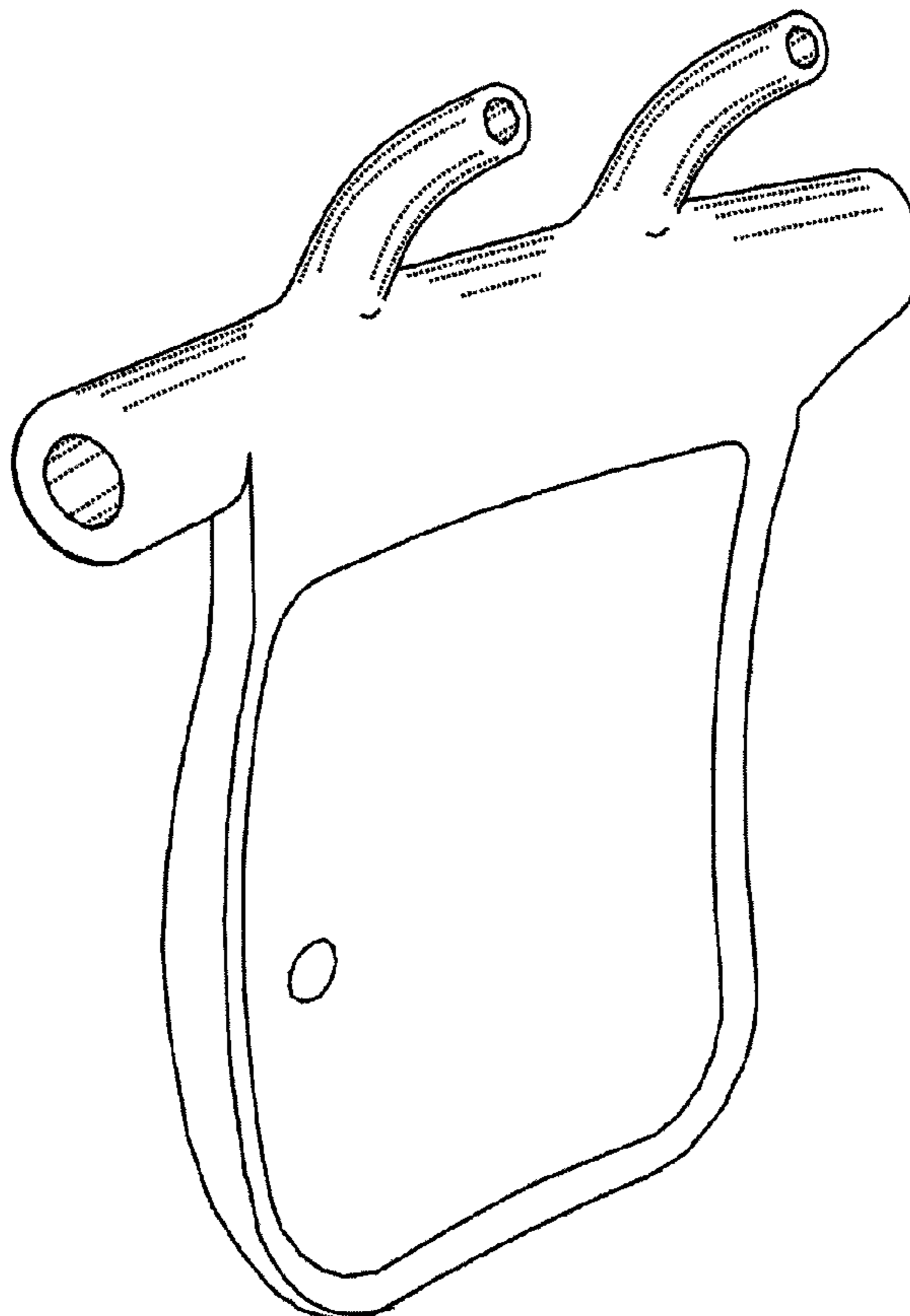

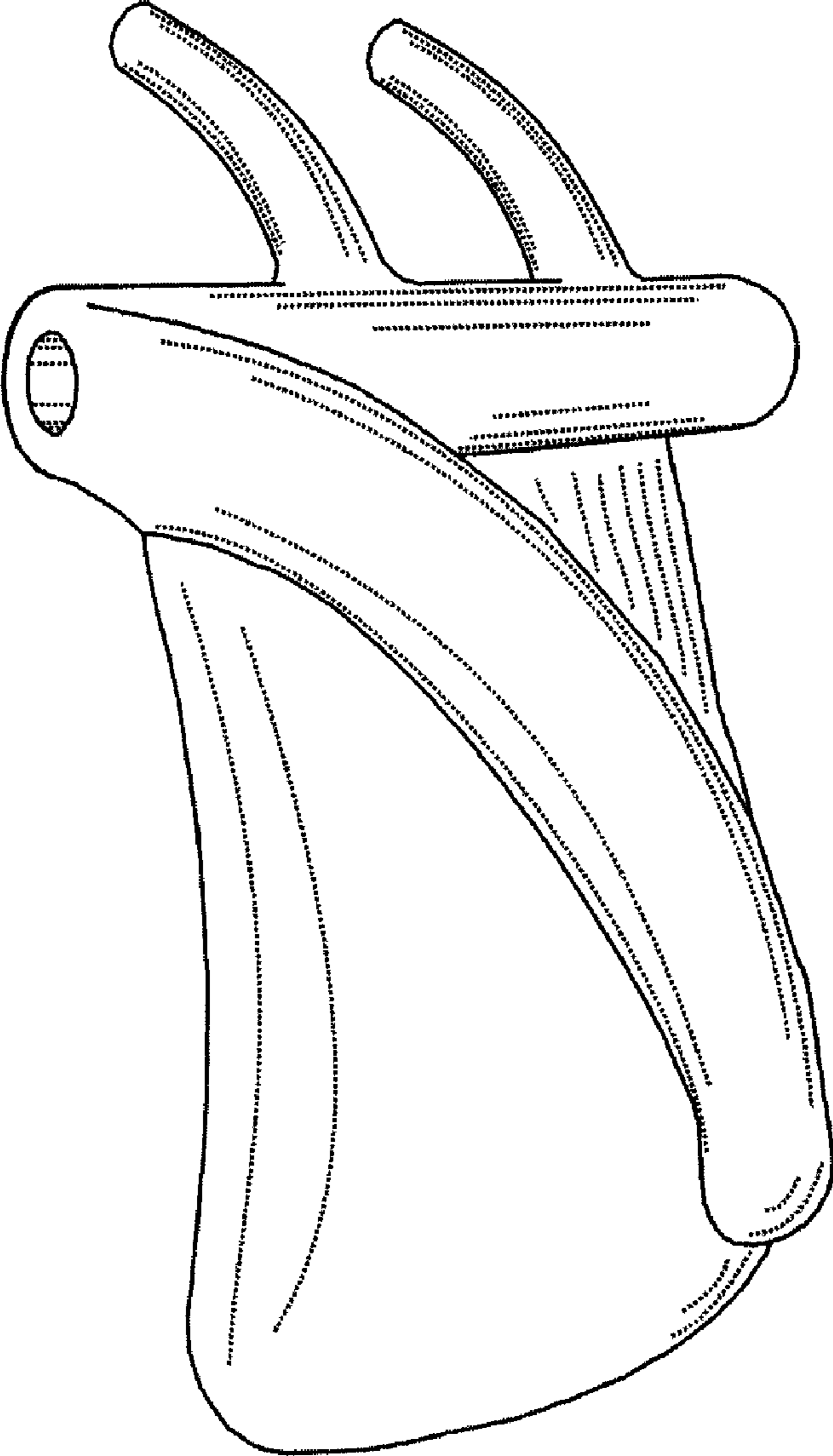

Figure 1

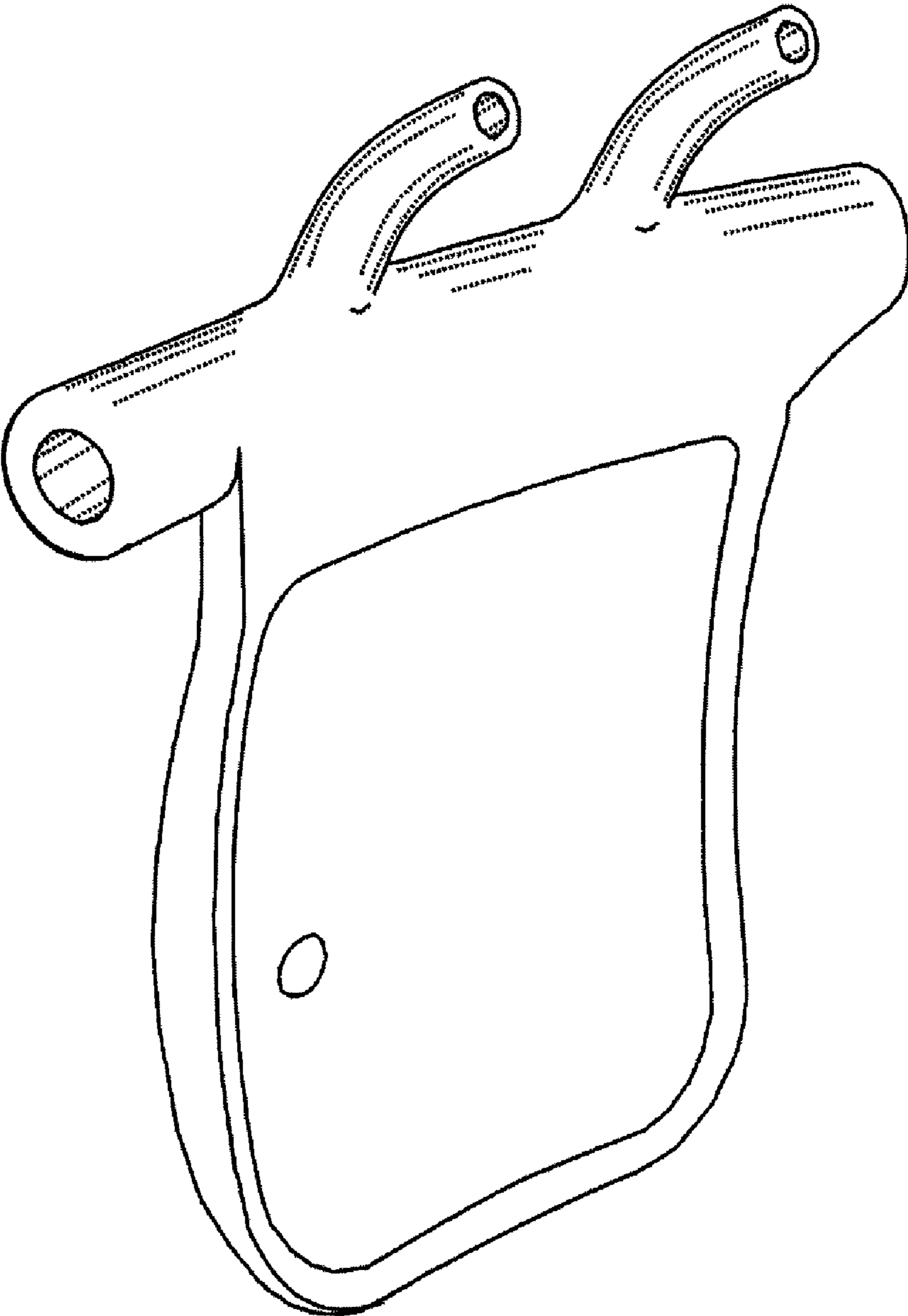

Figure 2

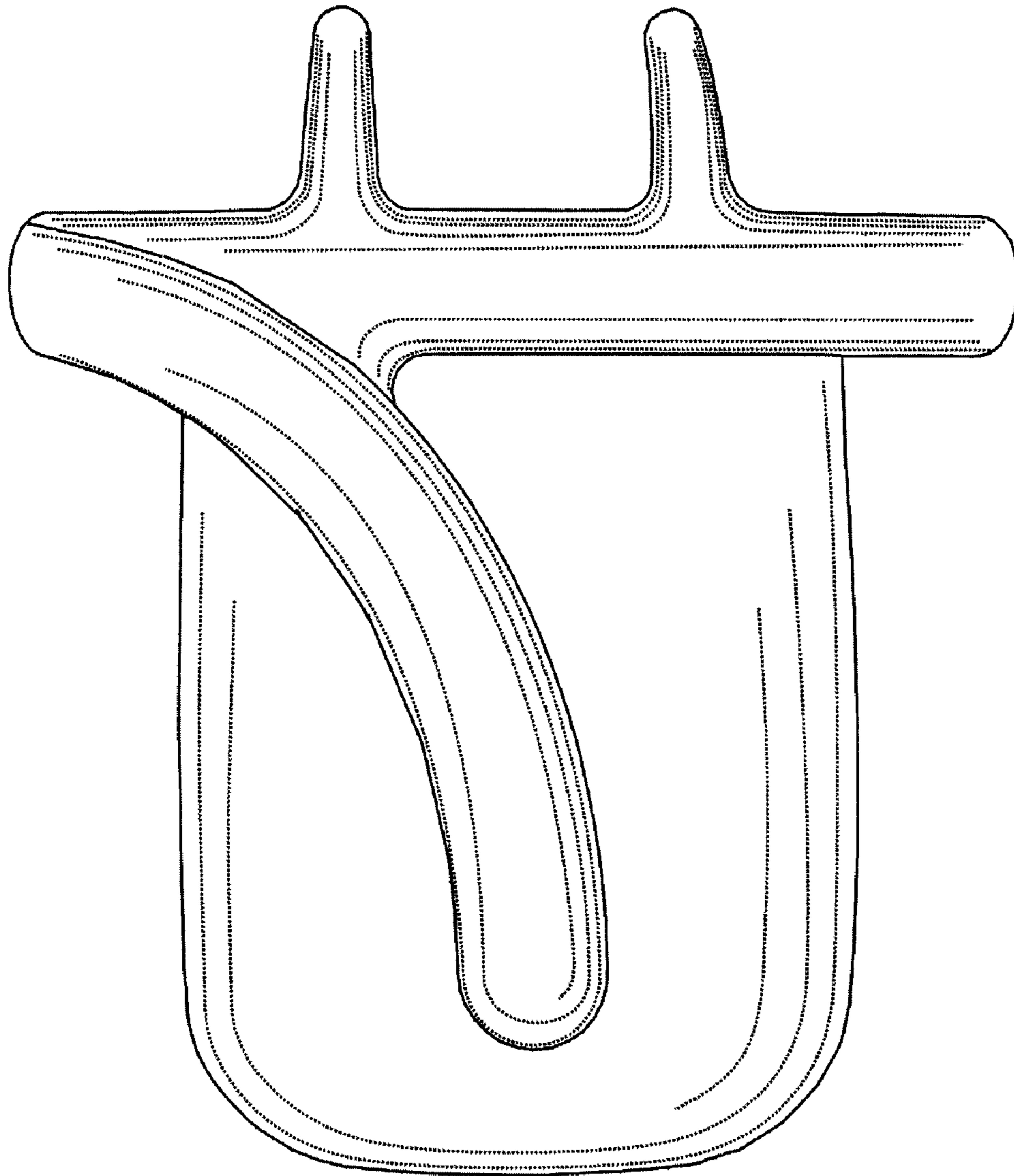

Figure 3

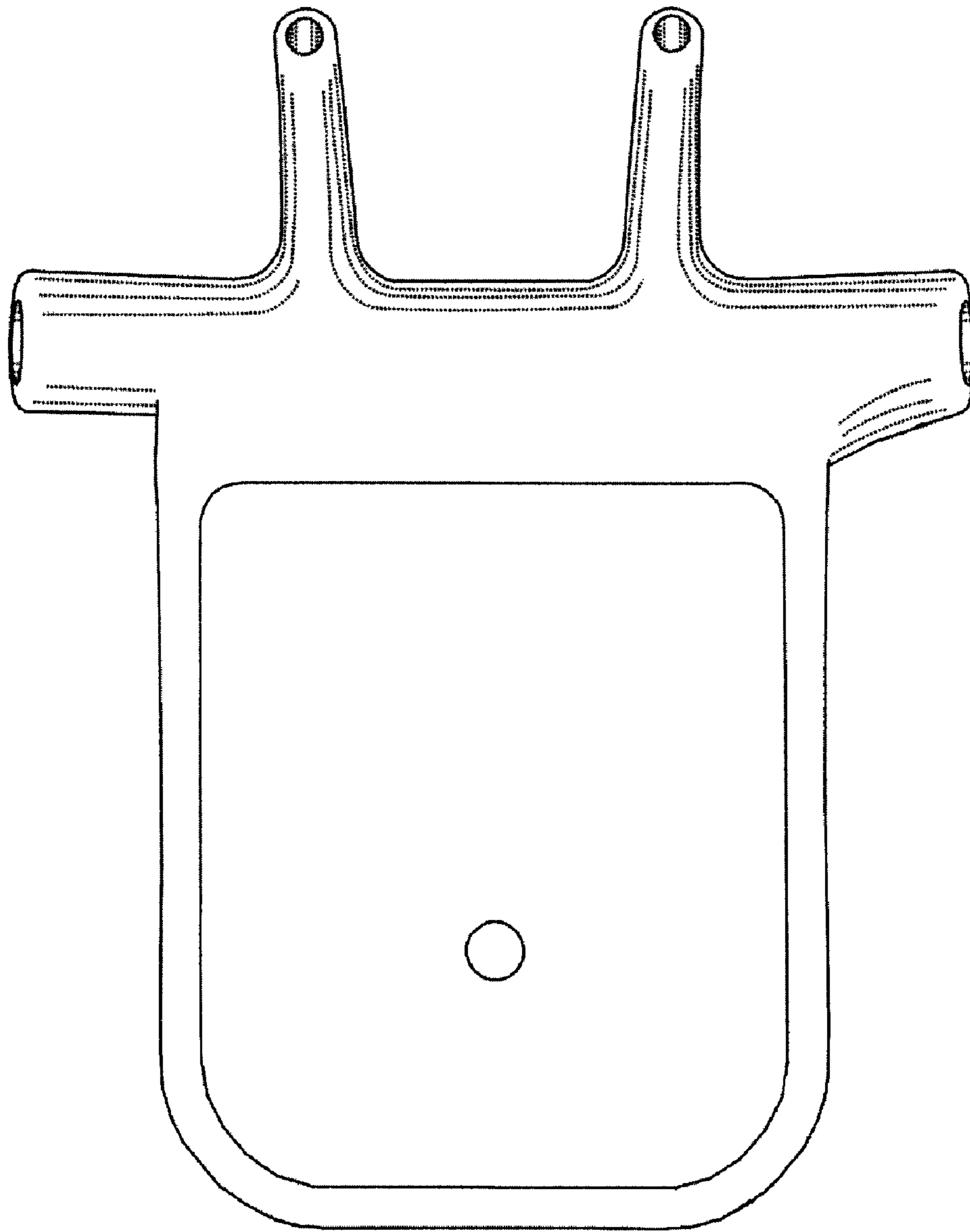

Figure 4



Figure 5

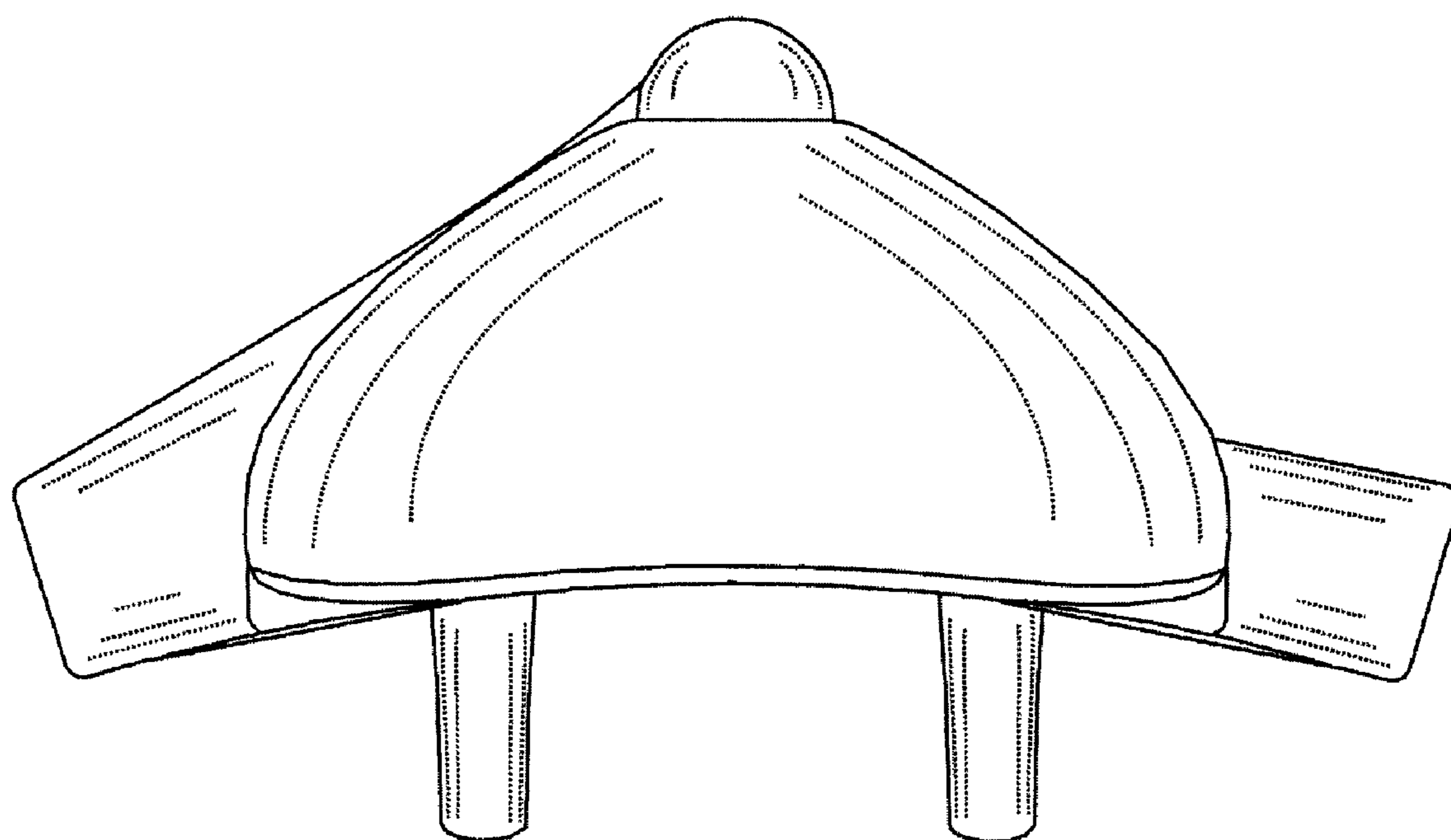

Figure 6

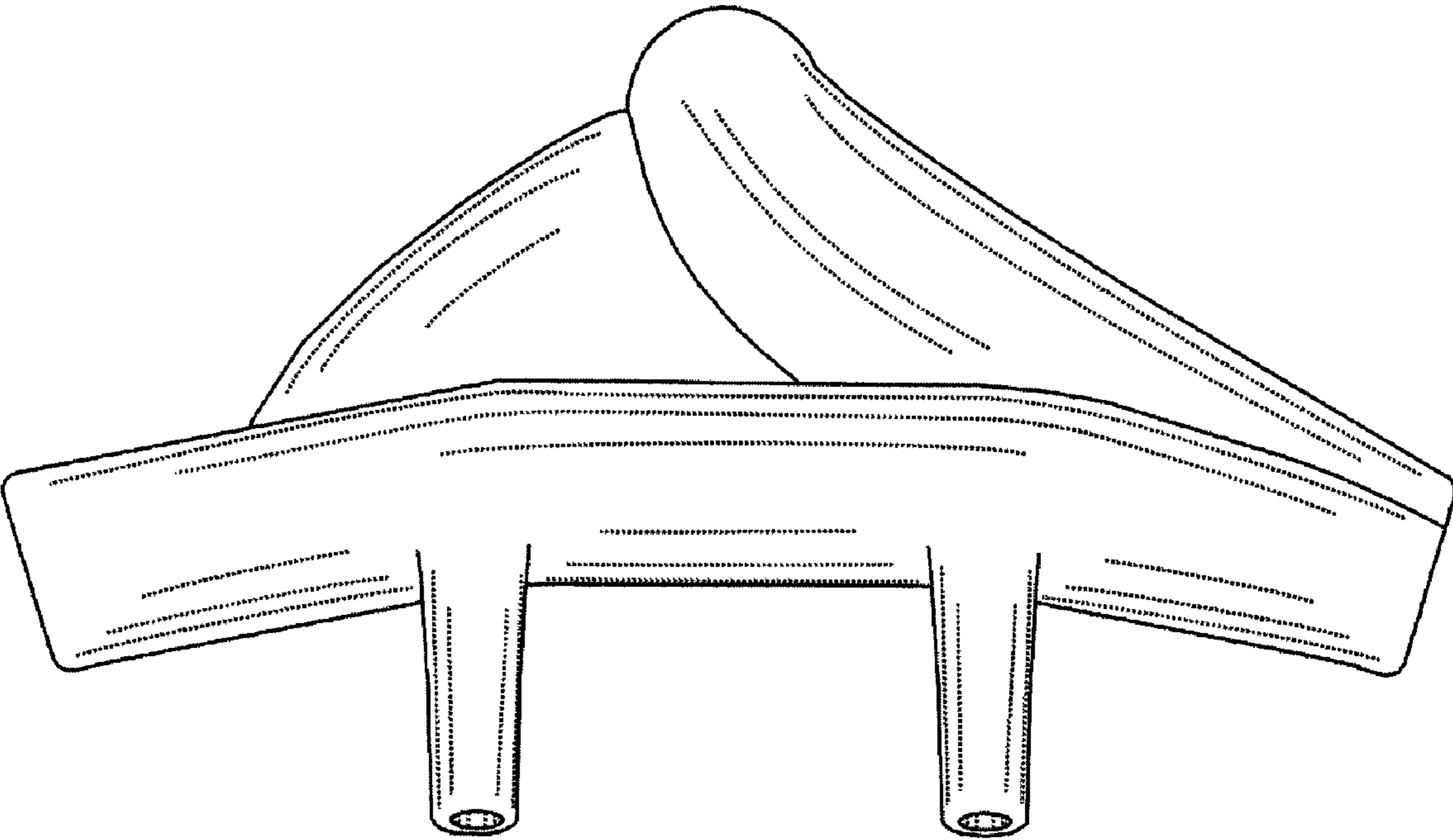

Figure 7