



US00D637193S

(12) **United States Design Patent**
Andre et al.

(10) **Patent No.:** **US D637,193 S**
(45) **Date of Patent:** **** May 3, 2011**

(54) **ELECTRONIC DEVICE**

(75) Inventors: **Bartley K. Andre**, Menlo Park, CA (US); **John M. Brock**, San Francisco, CA (US); **Matthew Phillip Casebolt**, Fremont, CA (US); **Brett William Degner**, Menlo Park, CA (US); **Ron Alan Hopkinson**, Campbell, CA (US); **Eugene Kim**, San Francisco, CA (US); **Chris Ligtenberg**, San Carlos, CA (US); **John Raff**, Menlo Park, CA (US); **David Yeh**, Redwood City, CA (US)

(73) Assignee: **Apple Inc.**, Cupertino, CA (US)

(**) Term: **14 Years**

(21) Appl. No.: **29/379,432**

(22) Filed: **Nov. 19, 2010**

(51) **LOC (9) Cl.** **14-02**

(52) **U.S. Cl.** **D14/436**

(58) **Field of Classification Search** D14/411,
D14/433, 435.1, 436, 480.1–480.7, 484.1,
D14/137, 155, 203.1–203.8, 240; 710/300,
710/301; 439/131, 135–147

See application file for complete search history.

(56) **References Cited**

U.S. PATENT DOCUMENTS

D270,055	S	*	8/1983	Irwin et al.	D14/367
D300,923	S	*	5/1989	Collins et al.	D13/156
D346,581	S	*	5/1994	Tattari	D13/103
D382,880	S	*	8/1997	Cienkus et al.	D14/240
6,109,939	A	*	8/2000	Kondo et al.	439/140
6,122,695	A	*	9/2000	Cronin	710/100
6,253,266	B1	*	6/2001	Ohanian	710/301
D448,425	S	*	9/2001	Hanazawa et al.	D21/332
6,295,565	B1	*	9/2001	Lee	710/301
D458,935	S	*	6/2002	Hiroki	D14/436
6,437,980	B1	*	8/2002	Casebolt	361/679.54
6,542,358	B1	*	4/2003	Kunz et al.	361/679.4
D491,951	S	*	6/2004	Yu et al.	D14/436
6,854,984	B1		2/2005	Lee et al.		

6,873,261	B2	*	3/2005	Anthony et al.	340/574
7,004,794	B2		2/2006	Wang et al.		
7,044,802	B2		5/2006	Chiou et al.		
7,052,287	B1		5/2006	Ni et al.		
7,074,052	B1		7/2006	Ni et al.		
7,249,978	B1		7/2007	Ni		
D548,740	S	*	8/2007	Takiar et al.	D14/436
7,252,518	B1		8/2007	Ni		
7,259,967	B2		8/2007	Ni		
7,364,445	B1		4/2008	Ni et al.		

(Continued)

OTHER PUBLICATIONS

X-Blade Toshiba gale Macbook Air SSD now available to all producers | Top Technology Reviews, [online], [retrieved on Feb. 3, 2011]. Retrieved from the Internet <URL: <http://top-technology-reviews.com/x-blade-toshiba-gale-macbook-air-ssd-now-available-to-all-producers/>>.*

(Continued)

Primary Examiner — Cathron Brooks

Assistant Examiner — Karen E Kearney

(74) *Attorney, Agent, or Firm* — SAIDMAN DesignLaw Group

(57) **CLAIM**

The ornamental design for an electronic device, as shown and described.

DESCRIPTION

FIG. 1 is a top, front, left perspective view of an electronic device showing our new design; FIG. 2 is a top view thereof; FIG. 3 is a bottom view thereof; FIG. 4 is right side view thereof; FIG. 5 is a left side view thereof; FIG. 6 is a front view thereof; and, FIG. 7 is a rear view thereof.

The broken lines are for the purpose of illustrating portions of the electronic device and form no part of the claimed design.

1 Claim, 5 Drawing Sheets

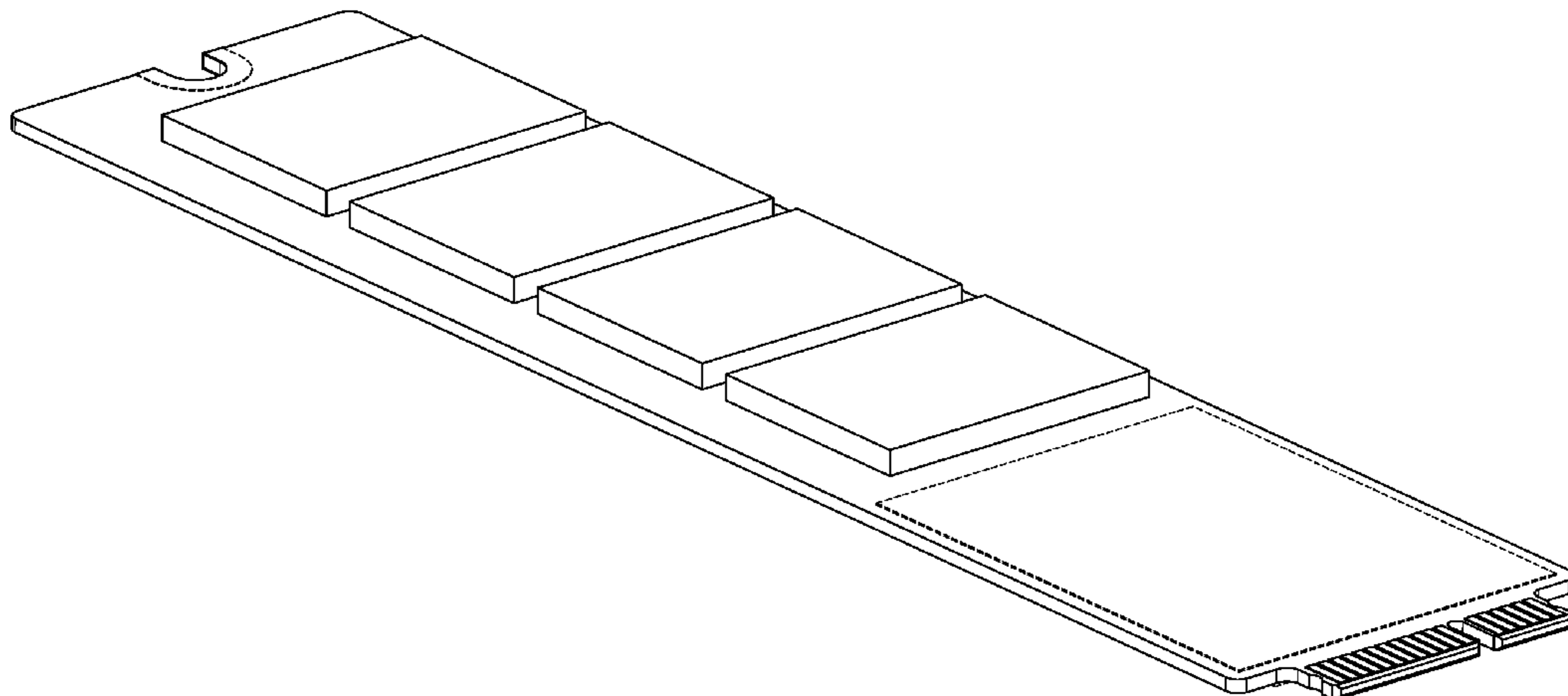

US D637,193 S

Page 2

U.S. PATENT DOCUMENTS

7,440,286 B2 * 10/2008 Hiew et al. 361/737
D591,292 S * 4/2009 Parker D14/383
7,577,789 B2 * 8/2009 Perego et al. 711/115
D603,812 S * 11/2009 Johnson et al. D13/182
D607,886 S * 1/2010 Bolotin et al. D14/480.1
7,644,867 B2 1/2010 Lin et al.
7,762,818 B2 * 7/2010 Hoang 439/62
7,836,237 B2 * 11/2010 Lien et al. 710/301
2002/0056018 A1 * 5/2002 Schumacher et al. 710/300
2003/0097506 A1 * 5/2003 Chuang 710/301
2004/0026516 A1 2/2004 Liu et al.
2006/0067054 A1 * 3/2006 Wang et al. 361/704
2008/0178025 A1 * 7/2008 Hand et al. 713/323
2008/0195817 A1 * 8/2008 Hiew et al. 711/115
2008/0266816 A1 * 10/2008 Ni et al. 361/737
2008/0270994 A1 * 10/2008 Li et al. 717/128
2009/0086448 A1 * 4/2009 Hiew et al. 361/753
2009/0153163 A1 * 6/2009 Han et al. 324/754

2009/0207681 A1 * 8/2009 Juengling 365/230.03
2010/0041261 A1 * 2/2010 Johnson et al. 439/174
2010/0062617 A1 * 3/2010 Bang et al. 439/61
2010/0265675 A1 10/2010 Aoki et al.
2011/0019370 A1 * 1/2011 Koh 361/749

OTHER PUBLICATIONS

Samsung launches netbook SSD line, [online] posted on Jun. 23, 2009 [retrieved on Feb. 10, 2011]. Retrieved from the Internet <URL: <http://liliputing.com/2009/06/samsung-launches-netbook-ssd-line.html>>.*

Toshiba rolls out Blade X-gale SSD modules, makes MacBook Air storage look a little less proprietary—Engadget, [online] posted Nov. 8, 2010 [retrieved on Feb. 10, 2011]. Retrieved from the Internet <URL: <http://www.engadget.com/2010/11/08/toshiba-rolls-out-blade-x-gale-ssd-modules-makes-macbook-air-st/>>.*

* cited by examiner

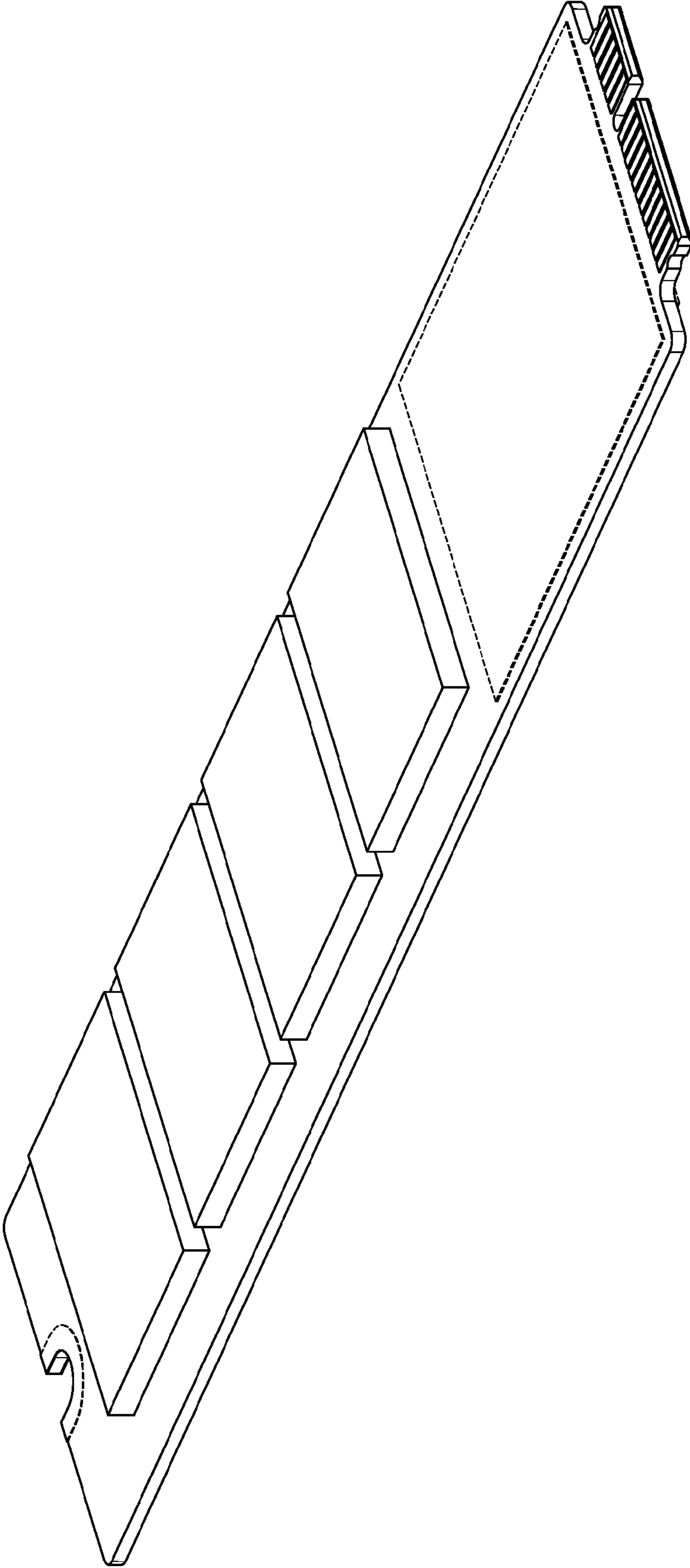

FIG. 1

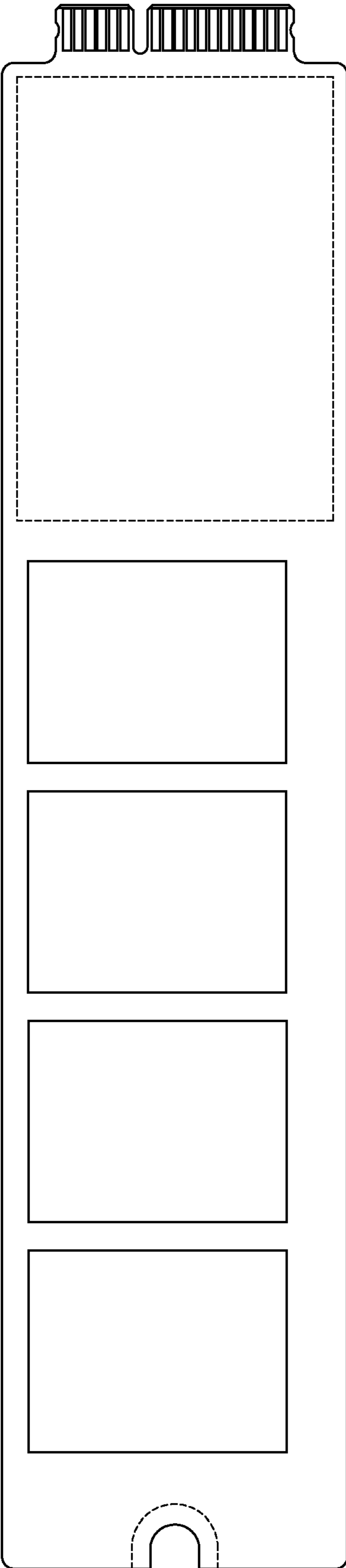

FIG. 2

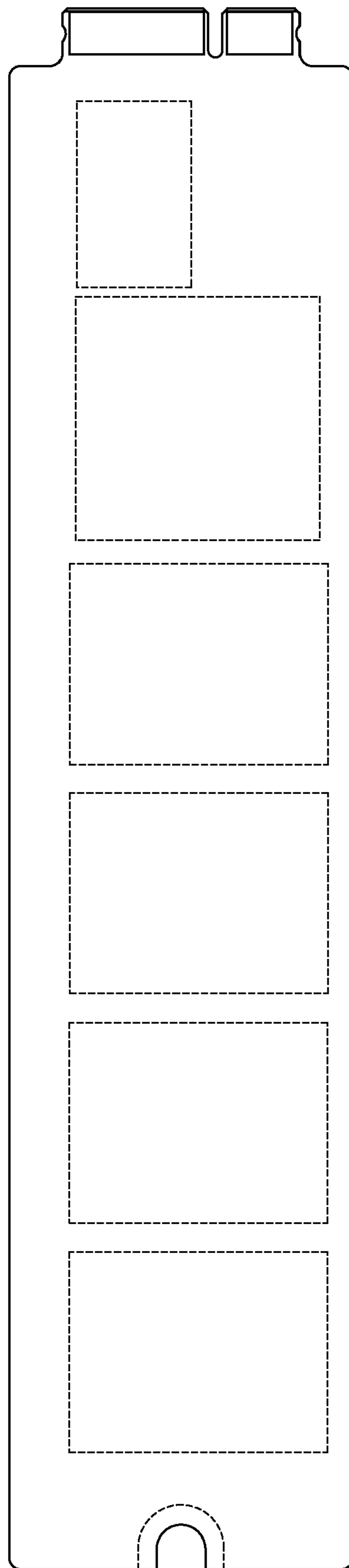

FIG. 3

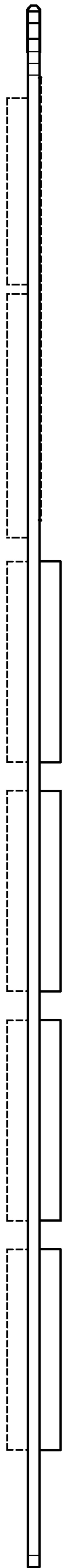

FIG. 4

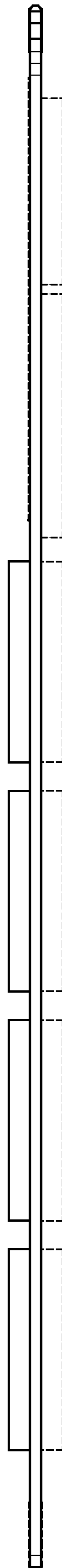

FIG. 5

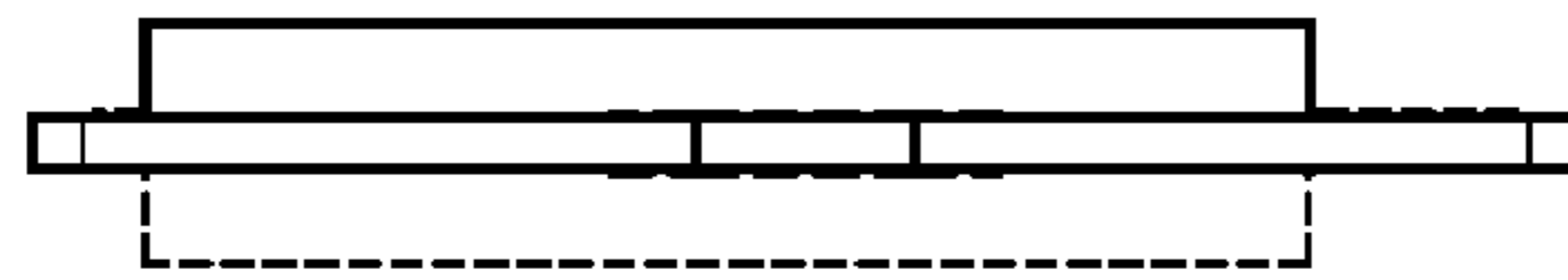

FIG. 6

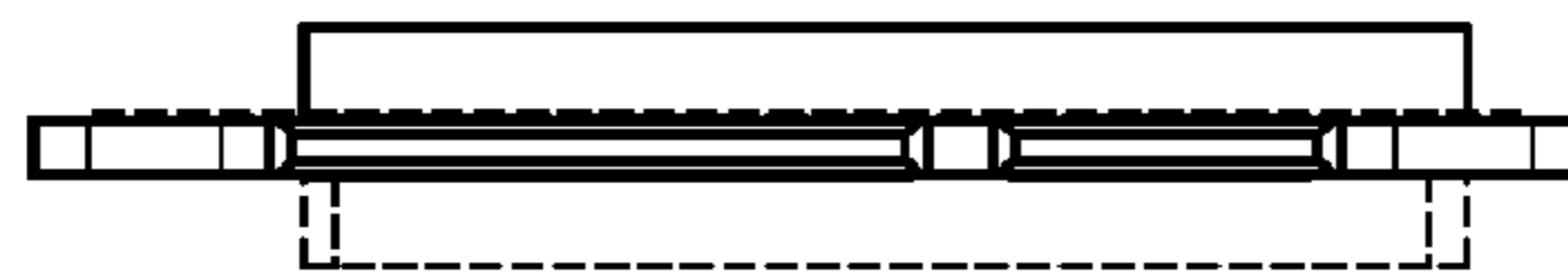

FIG. 7