



US00D637169S

(12) **United States Design Patent**
Kim et al.

(10) **Patent No.:** **US D637,169 S**

(45) **Date of Patent:** **** May 3, 2011**

(54) **TELEVISION RECEIVER**

(75) Inventors: **Yeonjin Kim**, Seoul (KR); **Kyongtae Han**, Gyeonggi-do (KR); **Changhun Lee**, Seoul (KR); **Yongho Lee**, Seoul (KR)

(73) Assignee: **LG Electronics Inc.**, Seoul (KR)

(**) Term: **14 Years**

(21) Appl. No.: **29/381,512**

(22) Filed: **Dec. 20, 2010**

(30) **Foreign Application Priority Data**

Jun. 22, 2010 (KR) 30-2010-0027488

(51) **LOC (9) Cl.** **14-03**

(52) **U.S. Cl.** **D14/126**

(58) **Field of Classification Search** D14/125-134,
D14/239, 371, 136, 374-377, 440, 450, 448,
D14/336, 342; 312/7.2; 348/836, 838, 180,
348/184, 325, 739; 341/12; 248/917-924,
248/465; 345/104, 133, 156, 168, 87, 173;
720/605, 669, 600, 655; 369/99, 197; D21/329,
D21/515, 577, 622, 333, 433, 448, 452, 450,
D21/331; D6/477, 479, 300; 273/148 B;
446/484, 175, 356; D10/15, 26

See application file for complete search history.

(56) **References Cited**

U.S. PATENT DOCUMENTS

D614,595	S	*	4/2010	Kubota	D14/126
D616,401	S	*	5/2010	Choi	D14/126
D617,291	S	*	6/2010	Lee	D14/126
D622,233	S	*	8/2010	Shin et al.	D14/126
D624,895	S	*	10/2010	Kasuga et al.	D14/126
D625,278	S	*	10/2010	Kim et al.	D14/126
D630,599	S	*	1/2011	Lim et al.	D14/126

* cited by examiner

Primary Examiner — Raphael Barkai

(74) *Attorney, Agent, or Firm* — Birch, Stewart, Kolasch & Birch, LLP

(57) **CLAIM**

The ornamental design for a television receiver, as shown and described.

DESCRIPTION

FIG. 1 is a top, front, perspective view of a television receiver showing our new design;
FIG. 2 is a front view thereof;
FIG. 3 is a rear view thereof;
FIG. 4 is a left side view thereof;
FIG. 5 is a right side view thereof;
FIG. 6 is a top view thereof;
FIG. 7 is a bottom view thereof; and,
FIG. 8 is a right side view thereof in an alternate position. The broken lines shown in FIG. 8 are for illustrative purposes only and form no part of the claimed design.

1 Claim, 7 Drawing Sheets

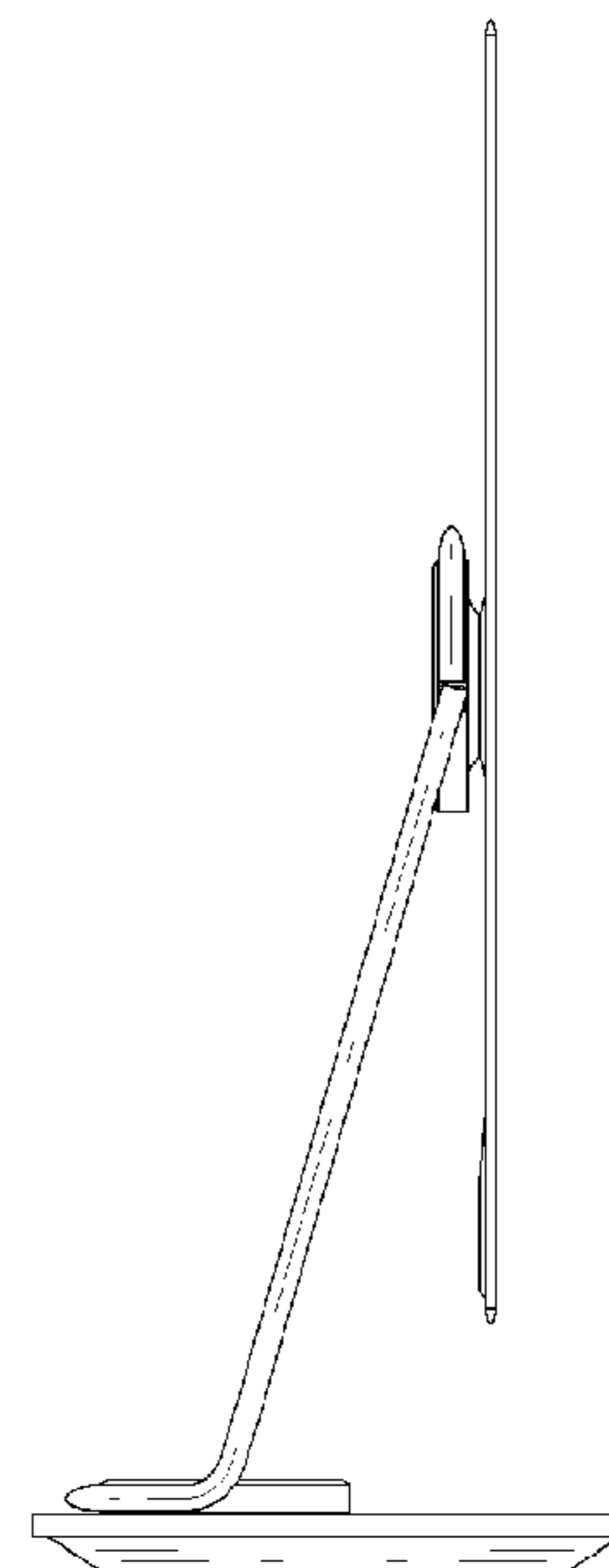
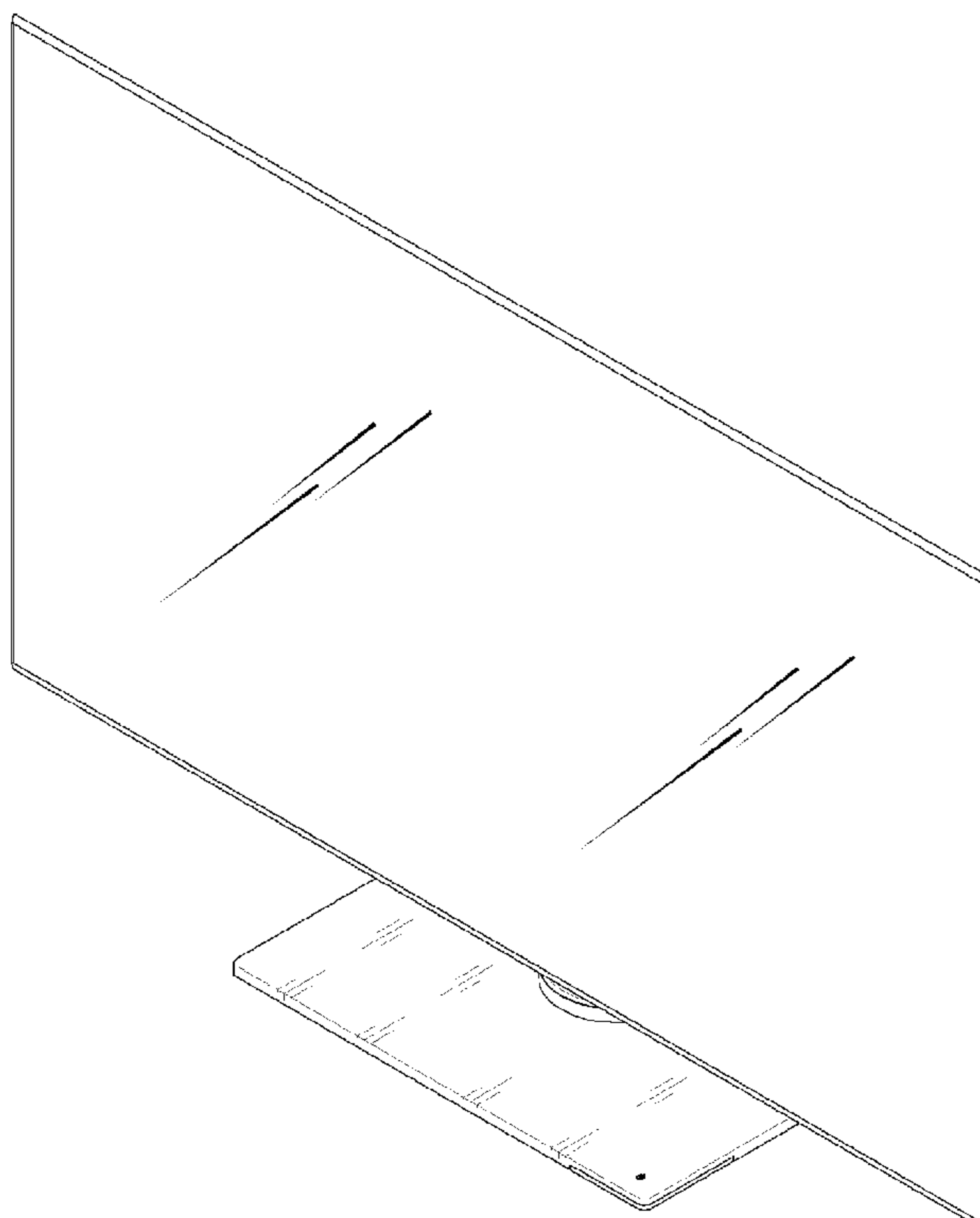

FIG. 1

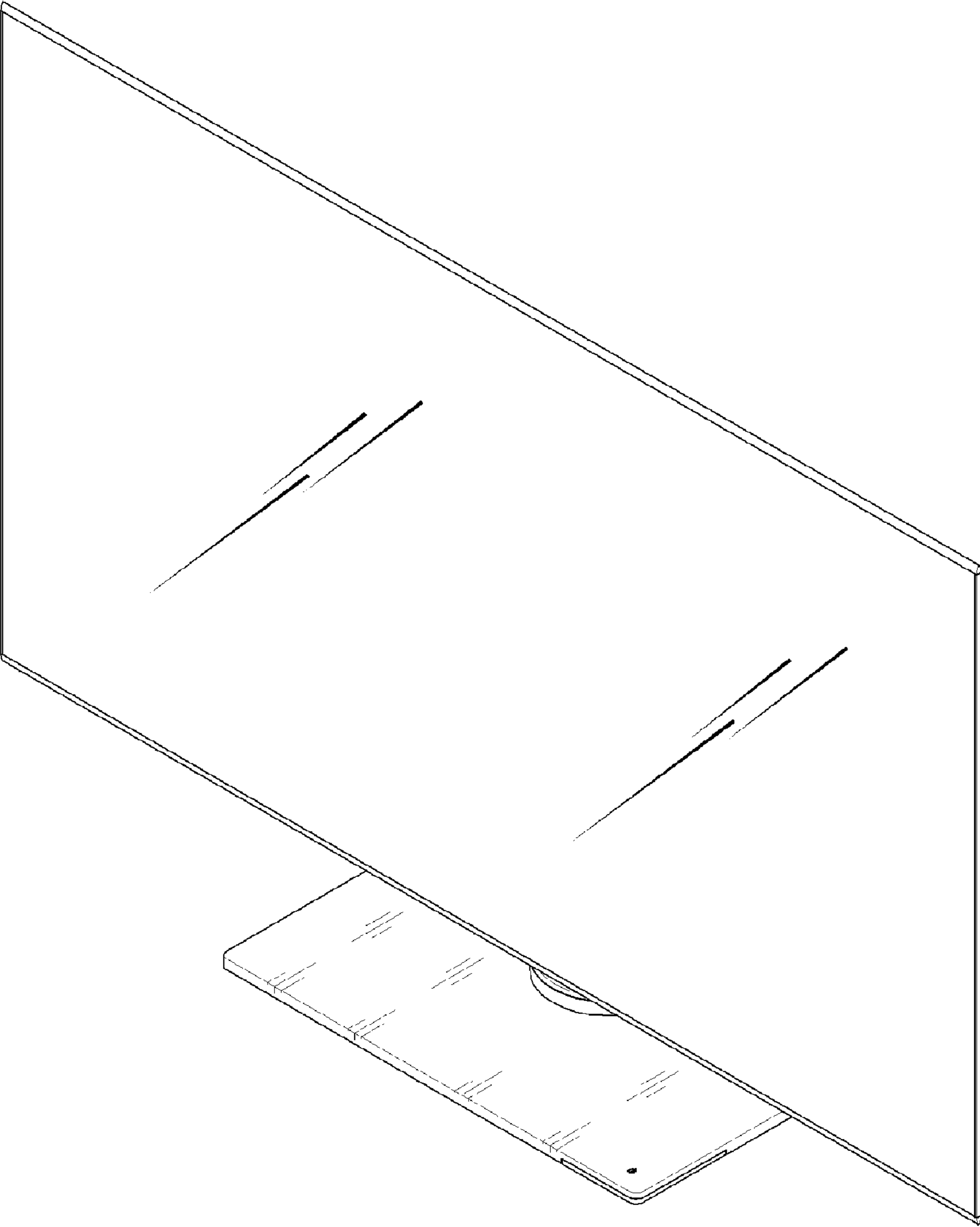

FIG. 2

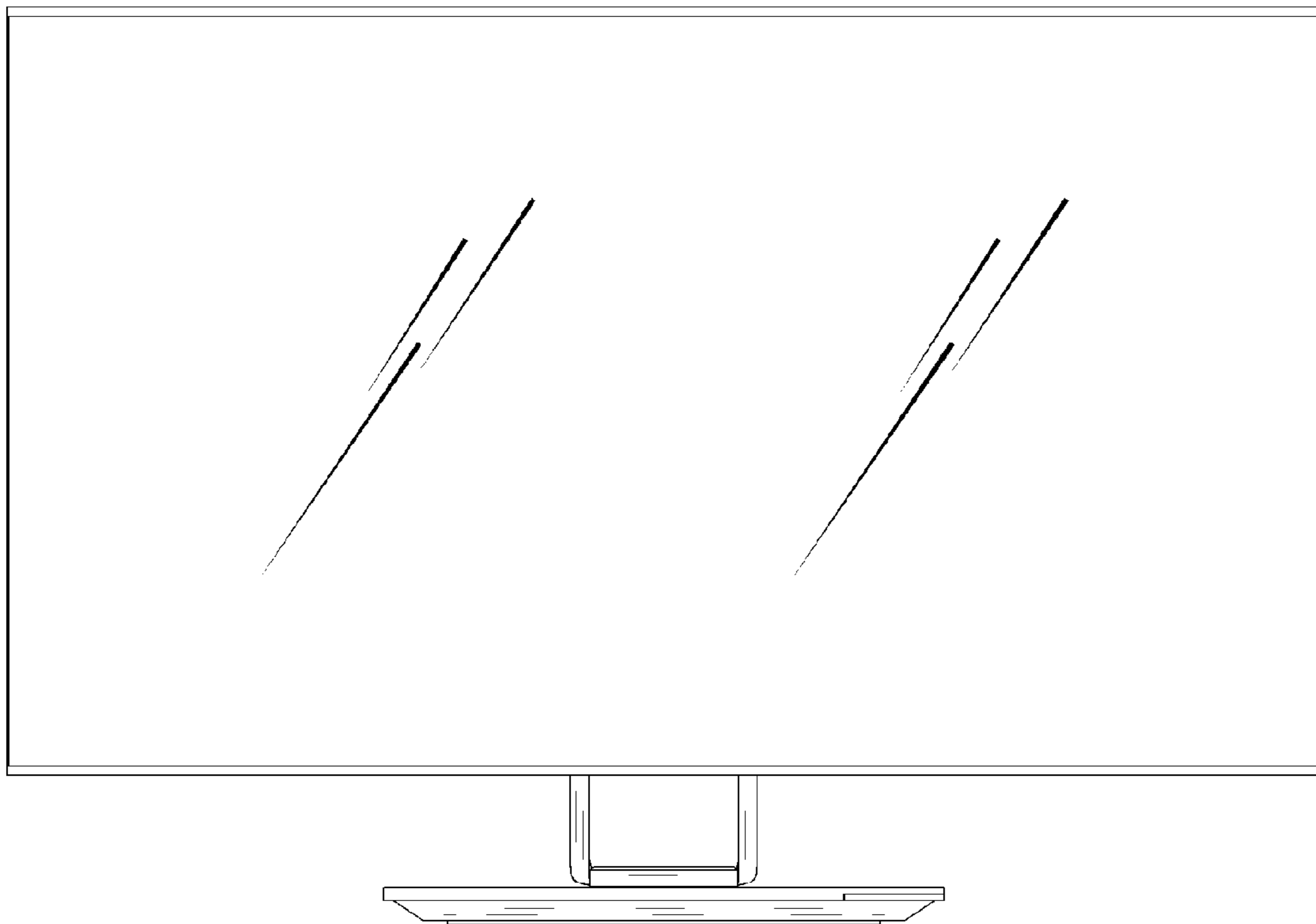

FIG. 3

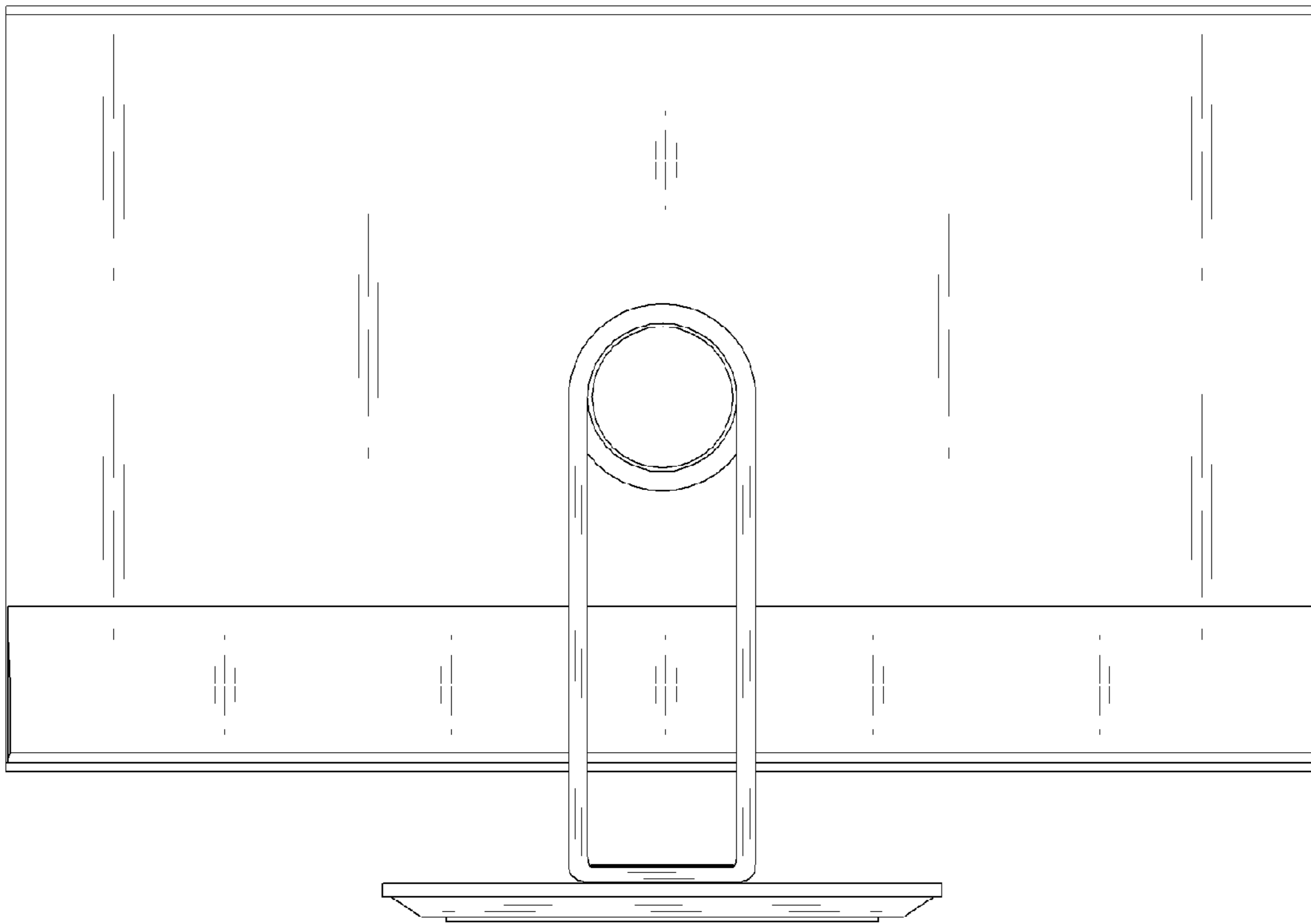

FIG. 4

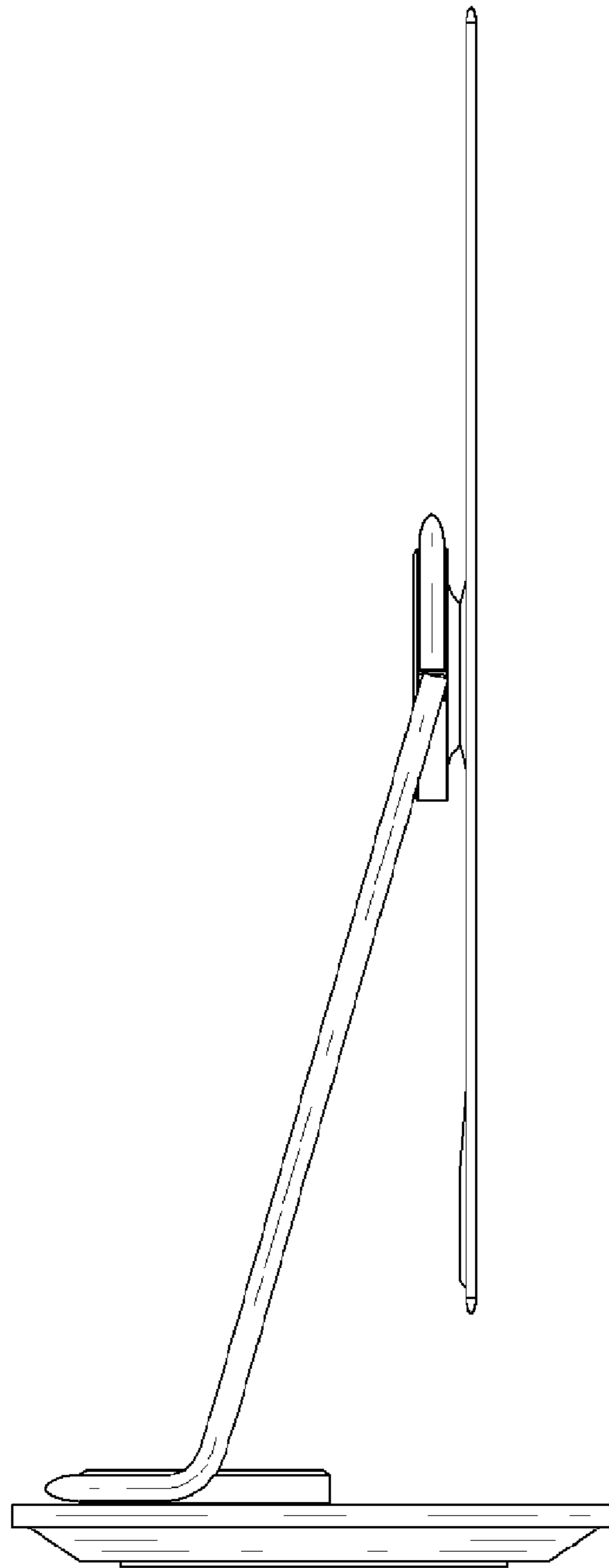

FIG. 5

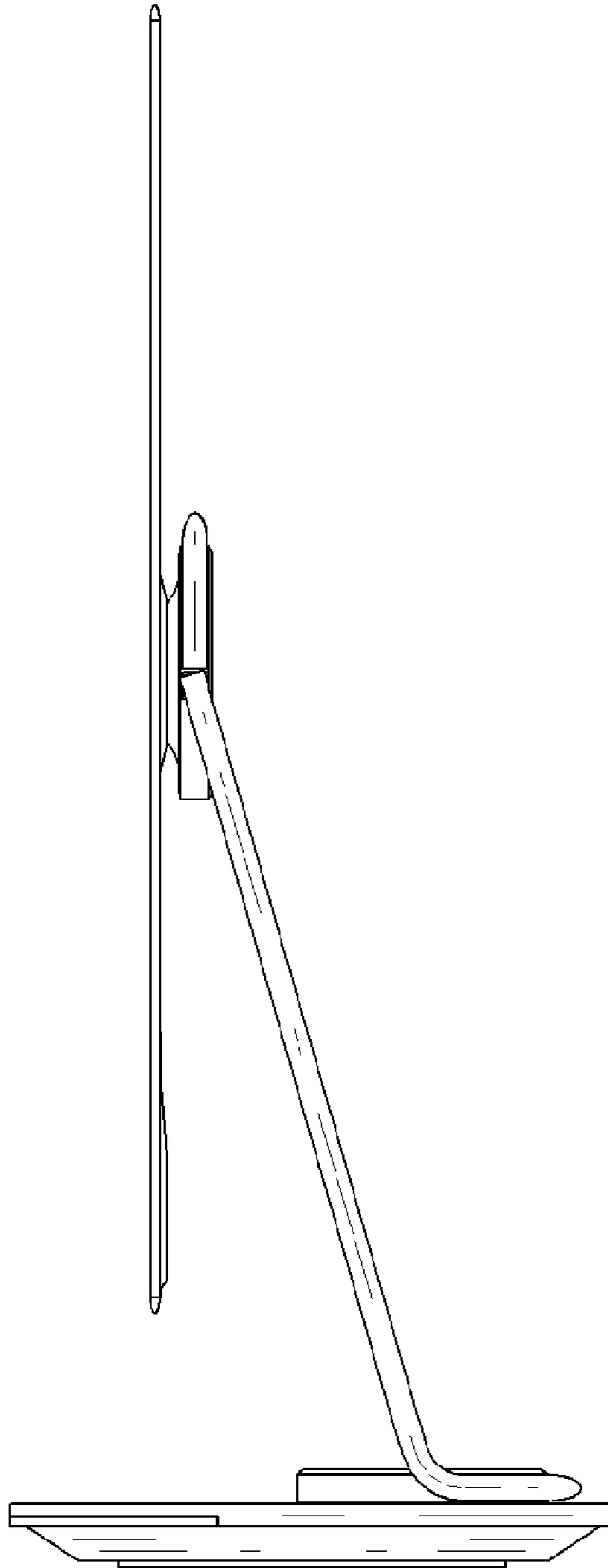

FIG. 6

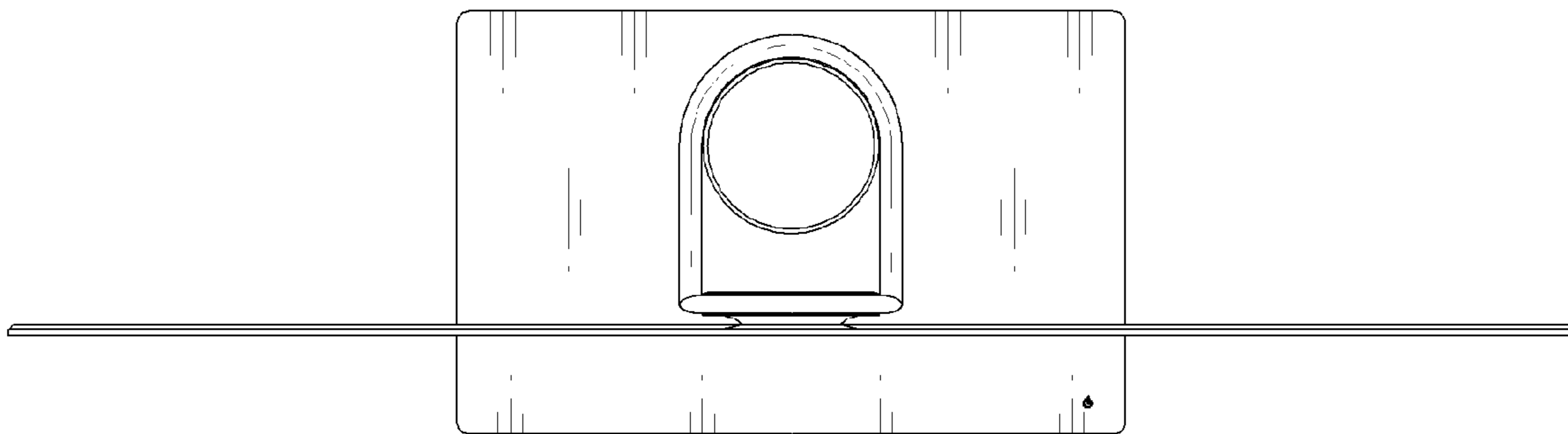

FIG. 7

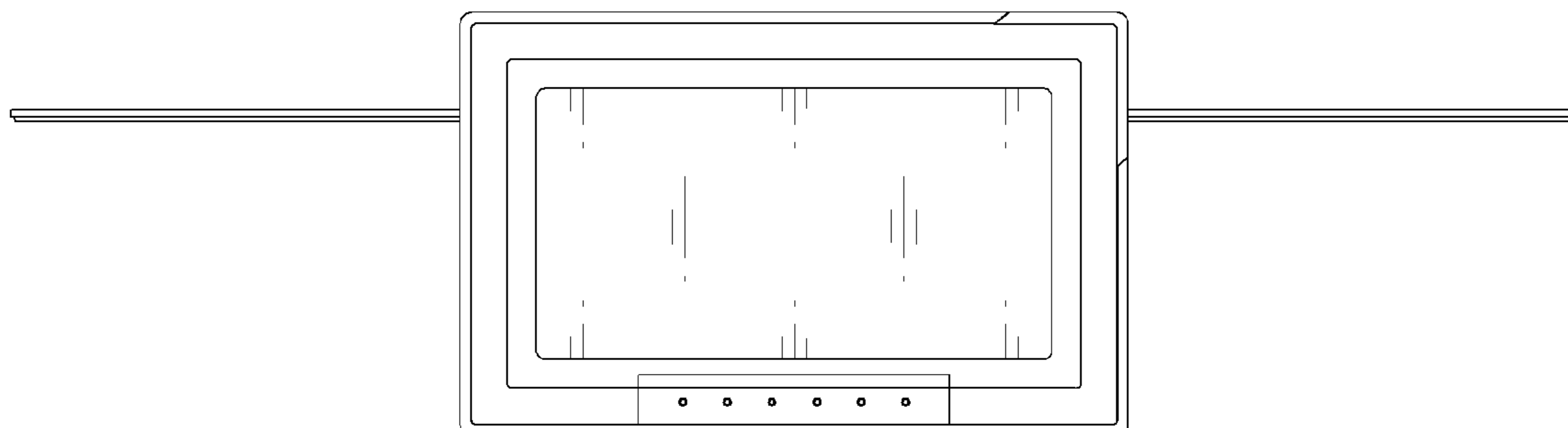

FIG. 8

