



US00D637020S

(12) **United States Design Patent**
Heimbrock et al.

(10) **Patent No.:** **US D637,020 S**
(45) **Date of Patent:** **** May 3, 2011**

(54) **SIDE RAIL FOR A BED**

(76) Inventors: **Richard H Heimbrock**, Cincinnati, OH (US); **Robert M Zerhusen**, Cincinnati, OH (US)

(**) Term: **14 Years**

(21) Appl. No.: **29/359,807**

(22) Filed: **Apr. 15, 2010**

Related U.S. Application Data

(62) Division of application No. 29/341,329, filed on Aug. 4, 2009, now Pat. No. Des. 616,678.

(51) **LOC (9) Cl.** **06-06**

(52) **U.S. Cl.** **D6/503**

(58) **Field of Classification Search** D6/382,
D6/392, 502; 5/424-426, 662, 732, 428,
5/611

See application file for complete search history.

(56) **References Cited**

U.S. PATENT DOCUMENTS

5,195,200	A	3/1993	Leoutsakos	
D336,577	S	6/1993	Celestina	
5,337,430	A	8/1994	Schlein	
5,394,581	A	3/1995	Leoutsakos	
D436,474	S	1/2001	Morren	
6,389,622	B1	5/2002	Her	
D479,070	S	9/2003	Goodwin	
7,150,058	B2	12/2006	Rabska	
7,296,312	B2	11/2007	Menkedick	
7,406,731	B2	8/2008	Menkedick	
7,644,457	B2	1/2010	Hensley	
D616,678	S *	6/2010	Heimbrock et al.	D6/503
D616,679	S *	6/2010	Heimbrock et al.	D6/503
D617,586	S *	6/2010	Heimbrock et al.	D6/503
D617,587	S *	6/2010	Heimbrock et al.	D6/503
D617,588	S *	6/2010	Heimbrock et al.	D6/503
D617,589	S *	6/2010	Heimbrock et al.	D6/503

D628,416	S *	12/2010	Heimbrock et al.	D6/503
2004/0177443	A1	9/2004	Simmonds	
2006/0038098	A1	2/2006	Metz	
2006/0059621	A1	3/2006	Poulos	
2009/0119839	A1	5/2009	Guguin	
2009/0229049	A1	9/2009	Heimbrock	

(Continued)

FOREIGN PATENT DOCUMENTS

WO 2006058506 A1 6/2006

OTHER PUBLICATIONS

http://www.arjohuntleigh.com/int/Product.asp?PageNumber=2571&ProductCategory_Id=128&Product_Id=202 ArjoHuntleigh, Enterprise 8000 Hospital Bed, Date: No later than Apr. 28, 2009.

(Continued)

Primary Examiner — Janice E Seeger

(74) *Attorney, Agent, or Firm* — Kenneth C. Baran

(57) **CLAIM**

The ornamental design for a side rail for a bed, substantially as shown and described.

DESCRIPTION

FIG. 1 is a perspective view of a side rail showing a laterally outboard side thereof.

FIG. 2 is a perspective view of the side rail showing a laterally inboard side thereof.

FIG. 3 is an outboard side elevation view of the side rail.

FIG. 4 is a rear elevation view of the side rail.

FIG. 5 is a front elevation view of side rail.

FIG. 6 is a top elevation view of the side rail.

FIG. 7 is a bottom elevation view of the side rail; and,

FIG. 8 is an inboard side elevation view of the side rail.

The broken lines are for environmental purposes only and form no part of the claimed design.

1 Claim, 6 Drawing Sheets

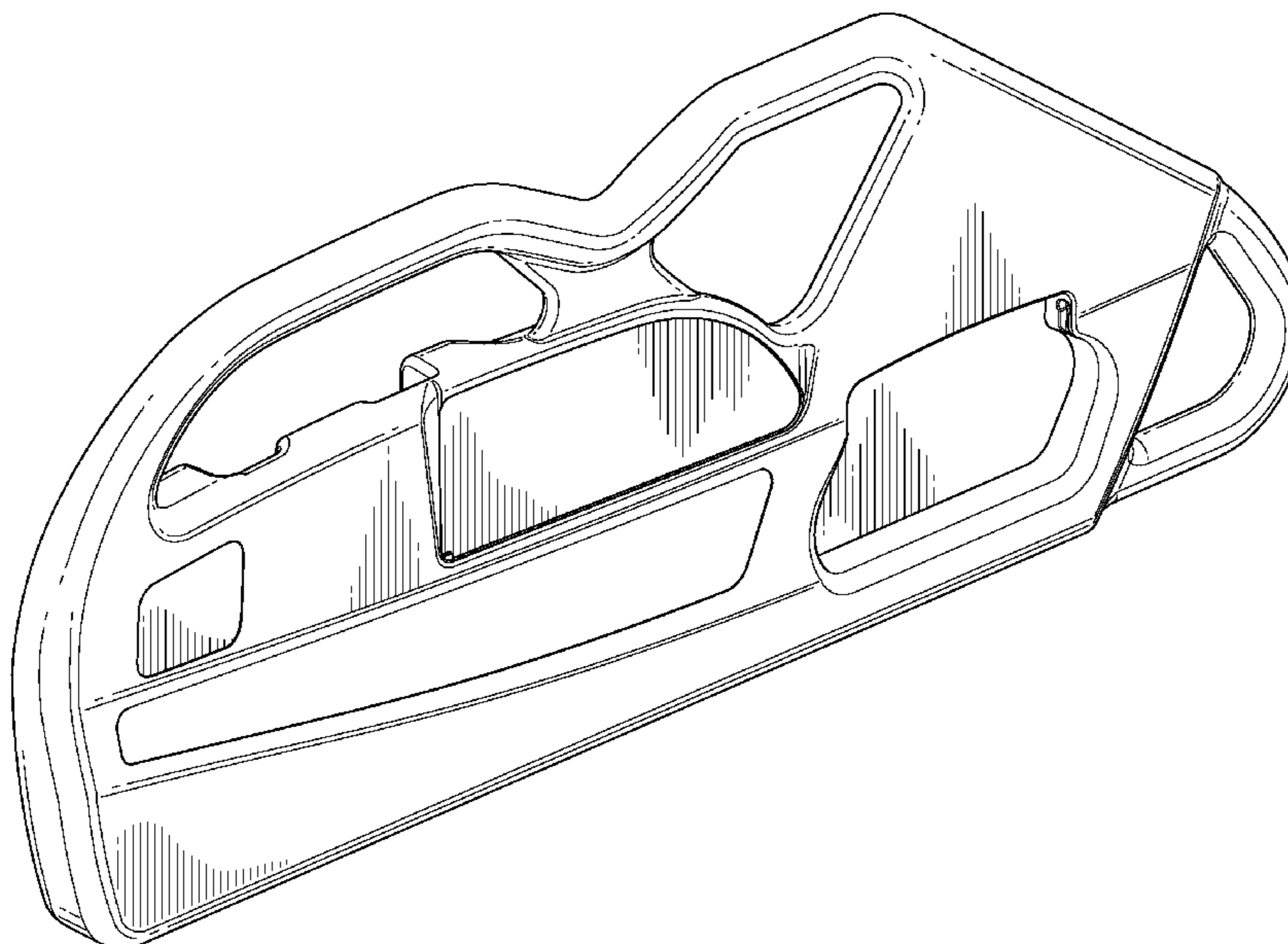

U.S. PATENT DOCUMENTS

2009/0229050 A1 9/2009 Heimbrock

OTHER PUBLICATIONS

http://www.arjohuntleigh.com/int/Product.asp?pagenumber=2571&Product_Id=291&ProductCategory_Id=128 ArjoHuntleigh, Enterprise 9000 Hospital Bed, Date: No later than Apr. 28, 2009.
http://www.arjohuntleigh.com/int/ProductDetails.asp?PageNumber=2571&ProductCategory_Id=128&Product_Id=291 ArjoHuntleigh, Enterprise 9000—Product Details—Nurse Handset, Date: No later than Apr. 28, 2009.
http://www.arjohuntleigh.com/int/ProductDetails.asp?PageNumber=2571&ProductCategory_Id=128&Product_Id=291 ArjoHuntleigh, Enterprise 9000—Product Details—Plug in controls allow for easy changes, Date: No later than Apr. 28, 2009.
Photo # 1297 (Hill-Rom Clinitron Rite-Hite), Date: No later than Feb. 14, 2009.
Photo # 1298 (Hill-Rom TotalCare Bariatric), Date: No later than Feb. 14, 2009.
Photo # 1299 (Hill-Rom 1000), Date: No later than Feb. 14, 2009.
Photo # 1300 (Hill-Rom Century P1400), Date: No later than Feb. 14, 2009.
Photo # 1301 (Hill-Rom Home Care), Date: No later than Feb. 14, 2009.
Photo # 1302 (Hill-Rom Affinity), Date: No later than Feb. 14, 2009.
Photo # 1303 (Hill-Rom Efica CC), Date: No later than Dec. 1994.
Photo # 1304 (Hill-Rom Efica CC), Date: No later than Dec. 1994.
Photo # 1305 (Hill-Rom Clinitron Elexis), Date: No later than Dec. 1993.
Photo # 1306 (Hill-Rom Clinitron Elexis), Date: No later than Dec. 1993.

Photo # 1307 (Hill-Rom Affinity), Date: No later than Feb. 14, 2009.
Photo # 1308 (Hill-Rom Century CC), Date: No later than Dec. 1987.
Photo # 1309 (Hill-Rom Clinitron), Date: No later than Feb. 14, 2009.
Photo # 1310 (Hill-Rom 1,000,000th Bed), Date: No later than Dec. 1974.
Photo # 1311 (Hill-Rom Unknown Model), Date: No later than Dec. 1976.
Photo # 1312 (Hill-Rom Unknown Model), Date: No later than Feb. 14, 2009.
Photo # 1313 (Hill-Rom Unknown Model), Date: No later than Feb. 14, 2009.
Photo # 1314 (Hill-Rom Unknown Model), Date: No later than Feb. 14, 2009.
Photo # 1315 (Hill-Rom CareAssist), Date: No later than Dec. 2004.
U.S. Appl. No. 61/225,921, filed Jul. 15, 2009 Titled “Siderail with Storage Area”, Applicant(s) Robert M. Zerhusen, Assignee Name and Address: Hill-Rom Services, Inc. 300 Delaware Ave., Suite 530 Wilmington, DE 19801.
U.S. Appl. No. 12/547,054, filed Aug. 25, 2009 Titled “Medical Line Manager”, Applicant(s) Richard H. Heimbrock, Assignee Name and Address: Hill-Rom Services, Inc. 300 Delaware Ave., Suite 530 Wilmington, DE 19801.
U.S. Appl. No. 12/546,756, filed Aug. 25, 2009 Titled “Siderail with Storage Area”, Applicant(s) Robert M. Zerhusen, Assignee Name and Address: Hill-Rom Services, Inc. 300 Delaware Ave., Suite 530 Wilmington, DE 19801.
U.S. Appl. No. 12/548,874, filed Aug. 27, 2009 Titled “Siderail with Storage Area”, Applicant(s) Charles A. Howell, Assignee Name and Address: Hill-Rom Services, Inc. 300 Delaware Ave., Suite 530 Wilmington, DE 19801.

* cited by examiner

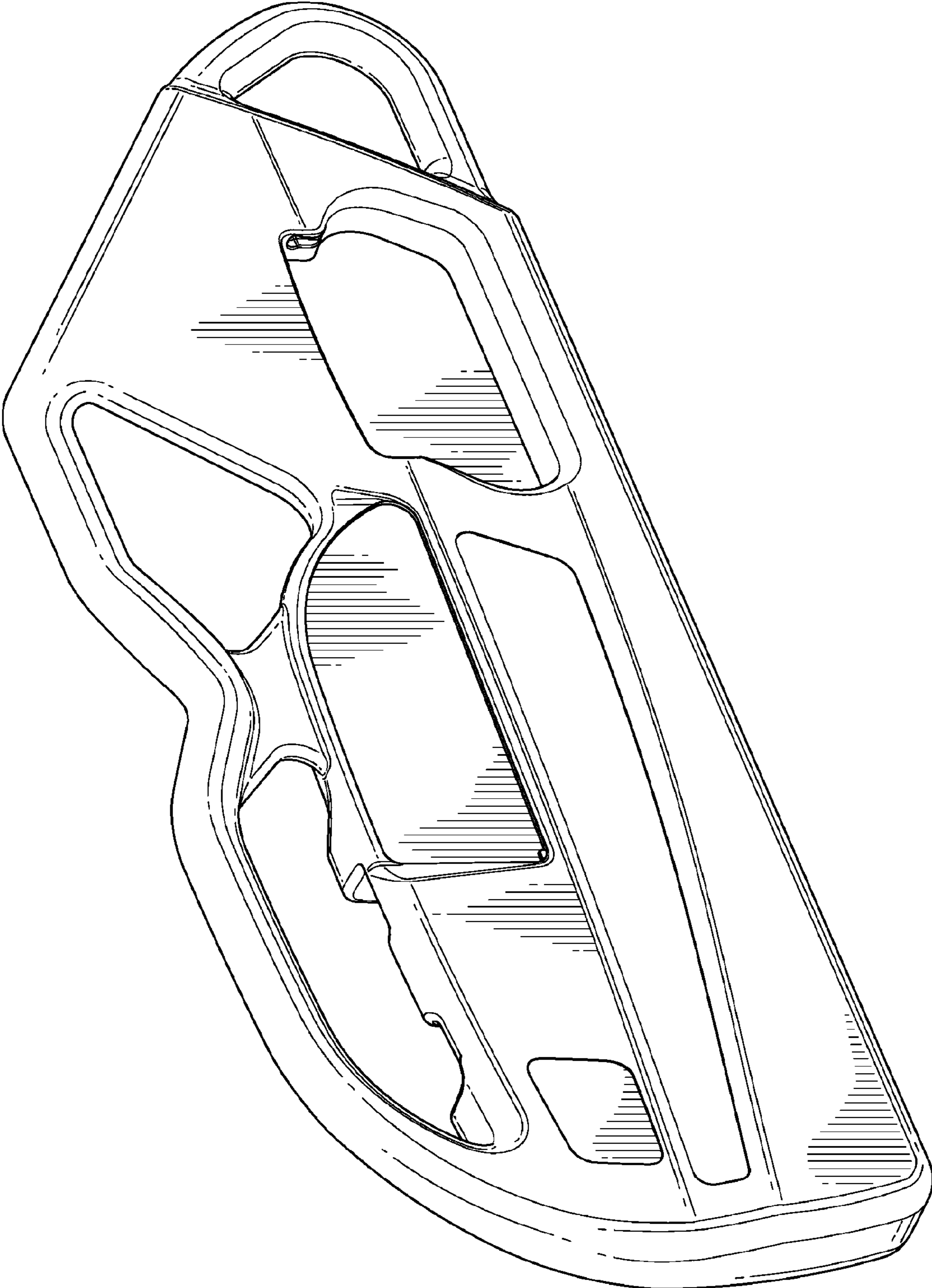

FIG. 1

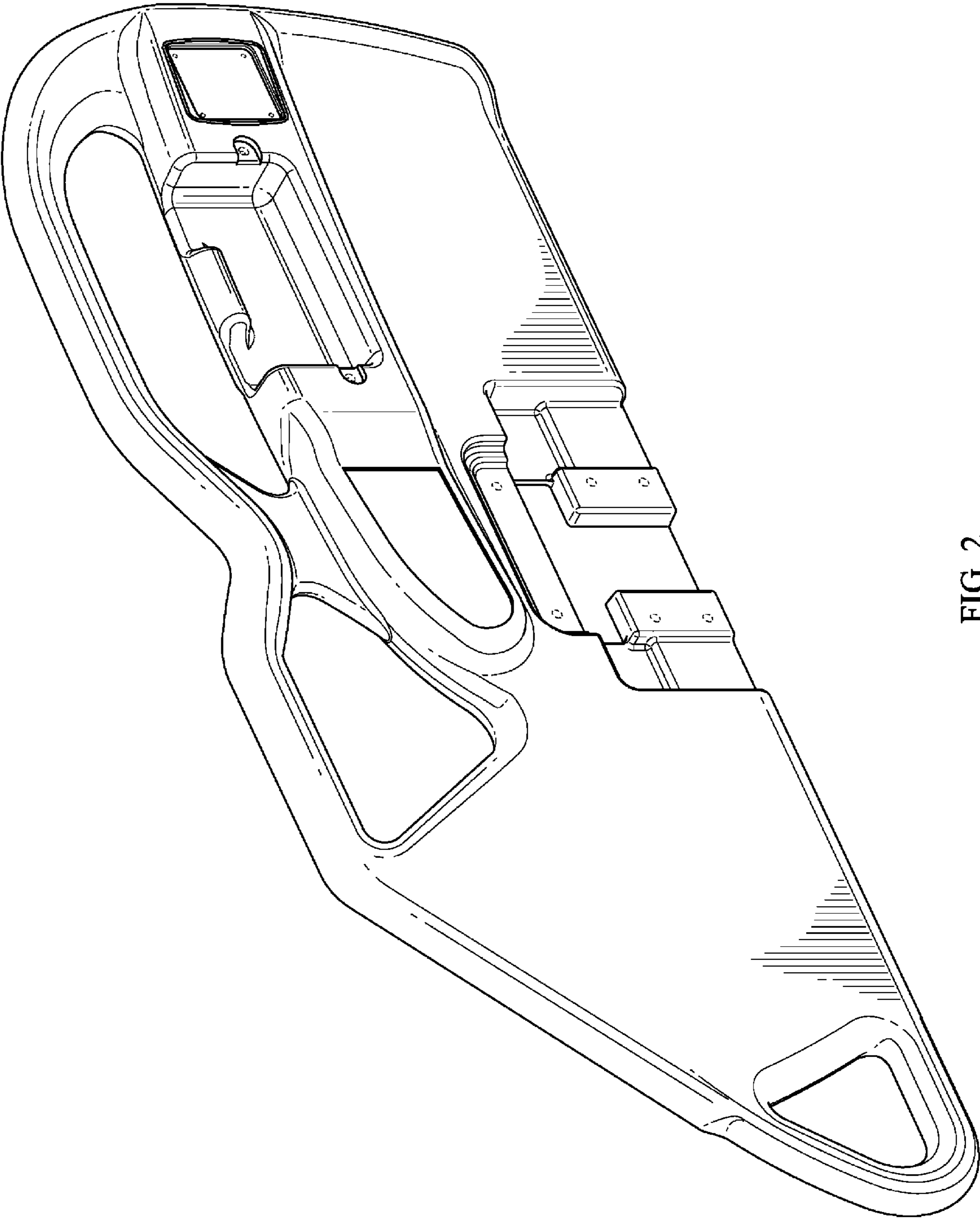

FIG. 2

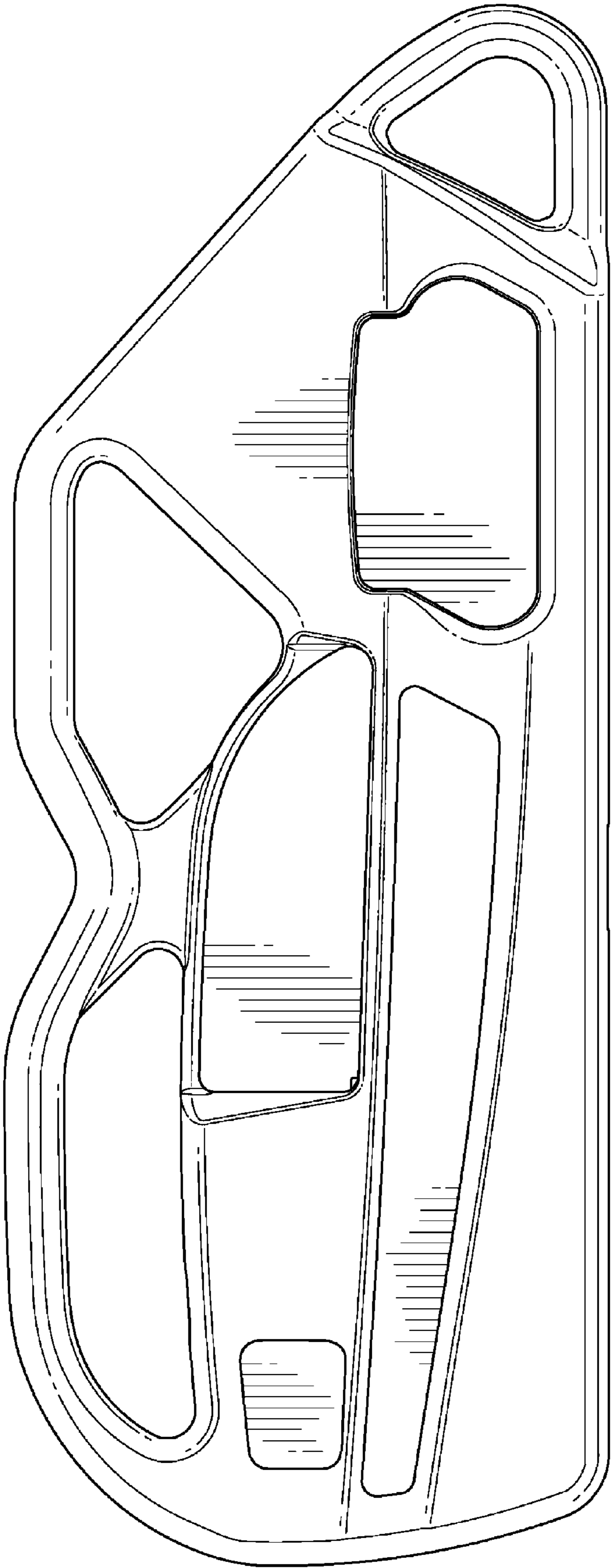

FIG. 3

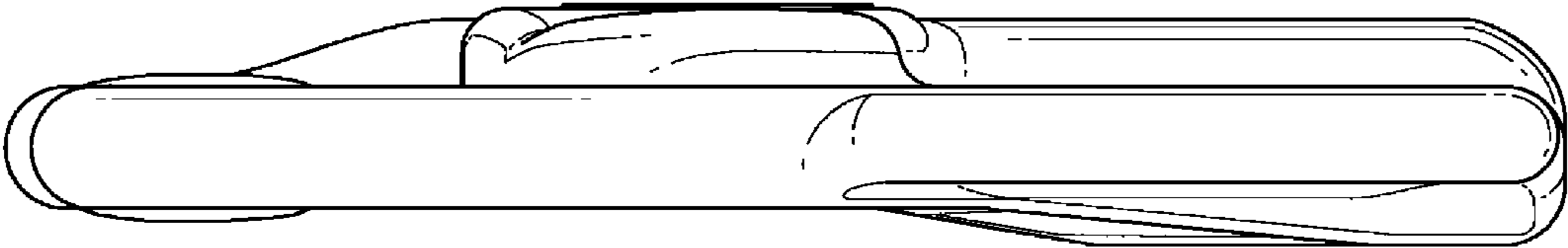

FIG. 5

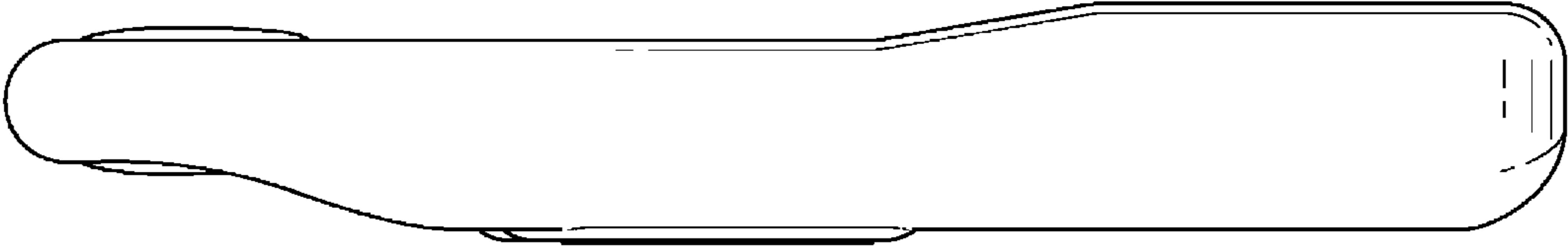

FIG. 4

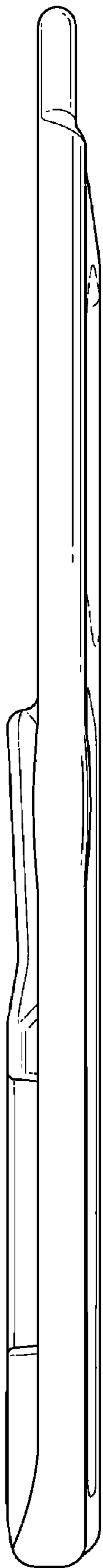

FIG. 6

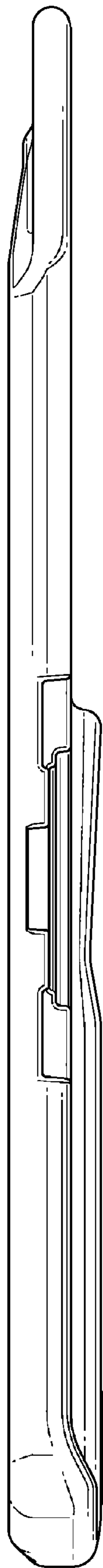

FIG. 7

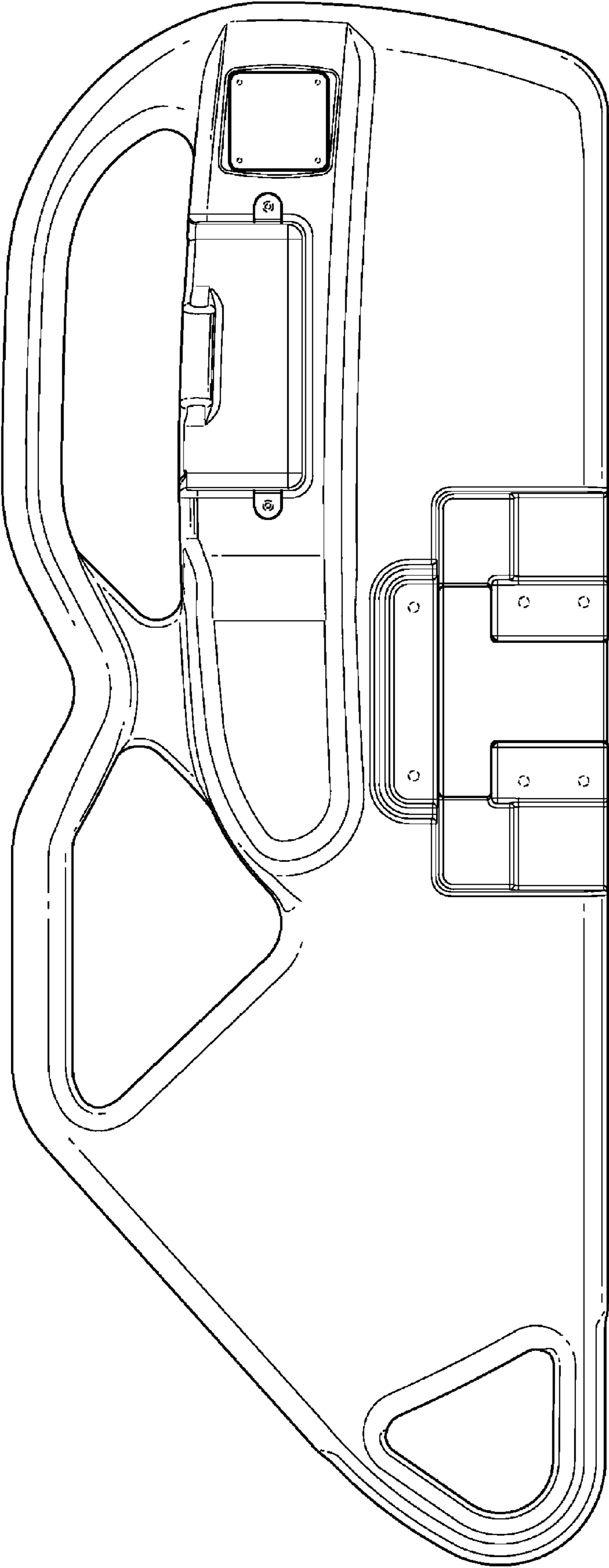

FIG. 8