



US00D636906S

(12) **United States Design Patent**
Leahy et al.

(10) **Patent No.:** **US D636,906 S**
(45) **Date of Patent:** **** Apr. 26, 2011**

(54) **LED LAMP FACE**

(75) Inventors: **James Leahy**, Greenwich, CT (US);
Edward Rodriguez, Wakefield, MA (US)

(73) Assignee: **Solais Lighting, Inc.**, Stamford, CT (US)

(**) Term: **14 Years**

(21) Appl. No.: **29/359,946**

(22) Filed: **Apr. 16, 2010**

(51) **LOC (9) Cl.** **26-04**

(52) **U.S. Cl.** **D26/2**

(58) **Field of Classification Search** D26/1-4;
313/313, 315, 316, 317, 318, 493; 315/52,
315/53, 56, 57, 58

See application file for complete search history.

(56) **References Cited**

U.S. PATENT DOCUMENTS

D435,577 S	*	12/2000	McBride	D16/203
D532,532 S	*	11/2006	Maxik	D26/2
D566,300 S	*	4/2008	Lo	D26/2
D581,555 S	*	11/2008	To et al.	D26/2
D582,578 S	*	12/2008	Tsai et al.	D26/2
D584,838 S	*	1/2009	To et al.	D26/2
D610,271 S	*	2/2010	Bi	D26/2

* cited by examiner

Primary Examiner — Marcus A Jackson

(74) *Attorney, Agent, or Firm* — Kristofer E. Elbing

(57) **CLAIM**

The ornamental design for a LED lamp face, as shown and described.

DESCRIPTION

This application is related to our United States Utility Patent Application entitled "Miniature Cellular Structure for Retrofit LED Lamp Secondary Optics" filed on the same day as the present application. This application is also related to a design application filed on the same day as this application and entitled LED Lamp Face and two design applications filed on the same day as this application and entitled LED Lamp.

FIG. 1 is a front perspective view of an LED lamp face showing our new design;

FIG. 2 is a rear perspective view of the LED lamp face of FIG. 1;

FIG. 3 is a side elevation view of the LED lamp face of FIG. 1;

FIG. 4 is a front elevation view of the LED lamp face of FIG. 1;

FIG. 5 is another side elevation view of the LED lamp face of FIG. 1 inverted with respect to the view of FIG. 3; and,

FIG. 6 is a rear elevation view of the LED lamp face of FIG. 1.

The broken line showing of the remaining portion of the Bulb is included for the purpose of illustrating only and forms no part of the claimed design.

1 Claim, 3 Drawing Sheets

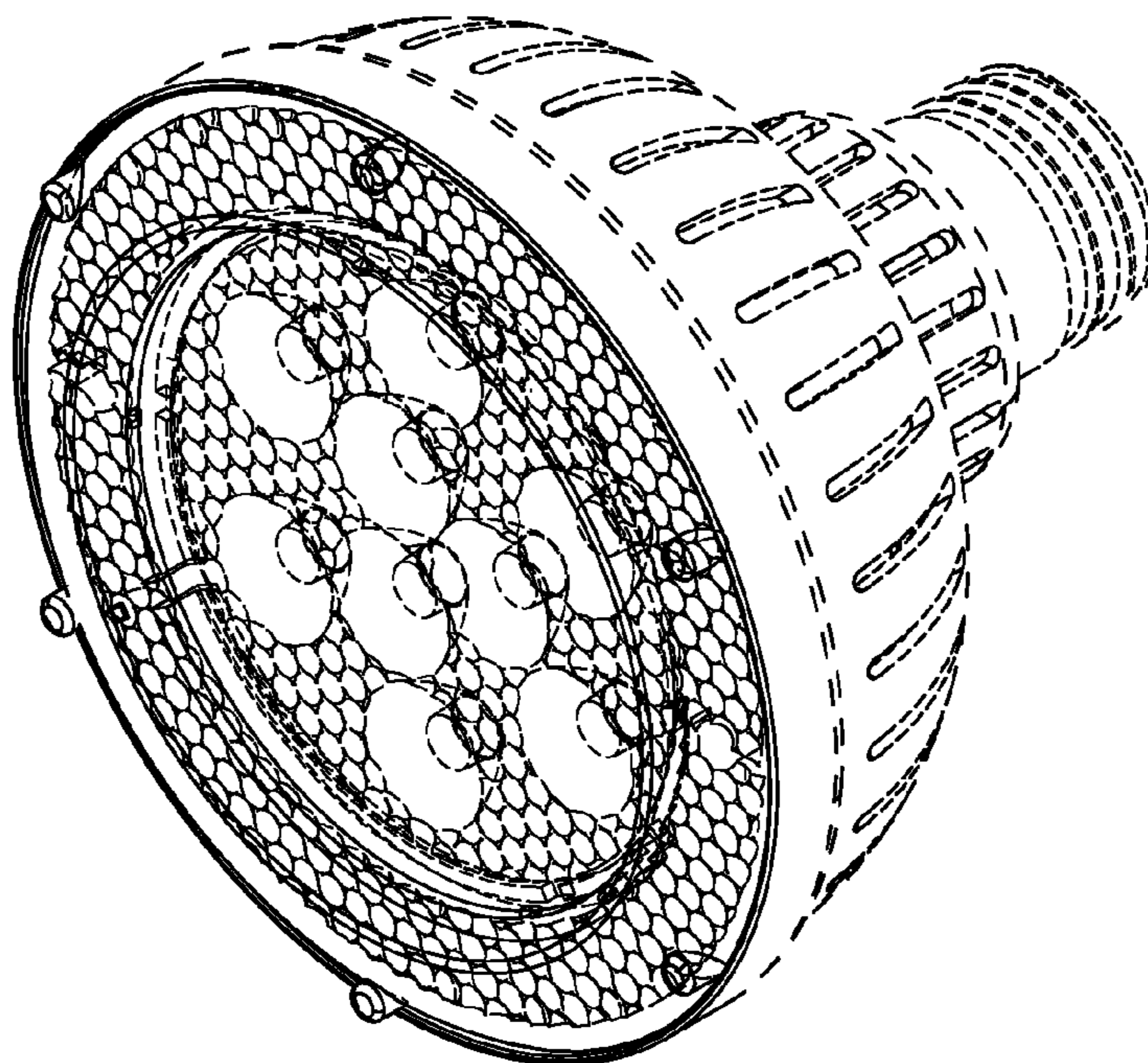

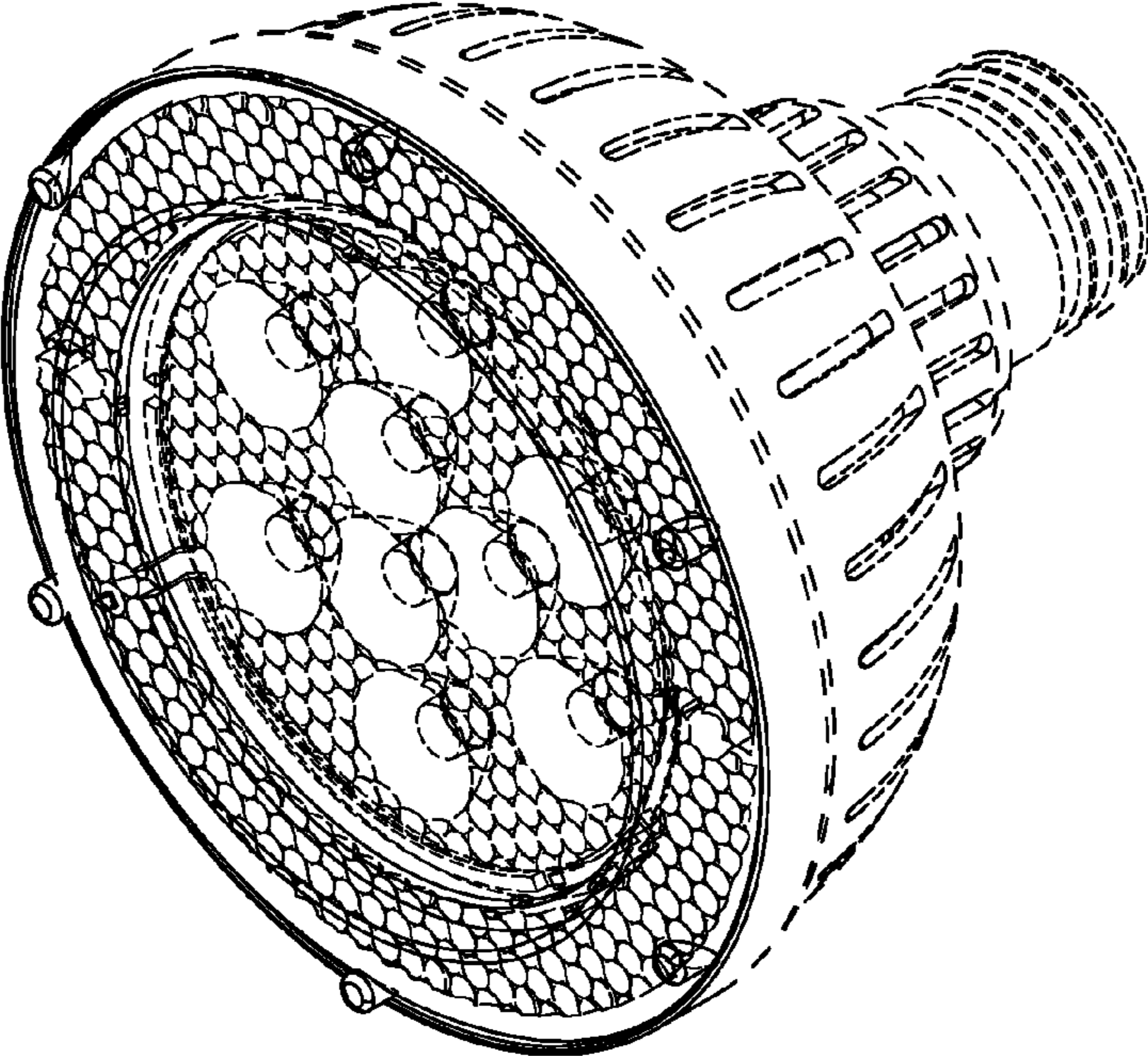

FIG. 1

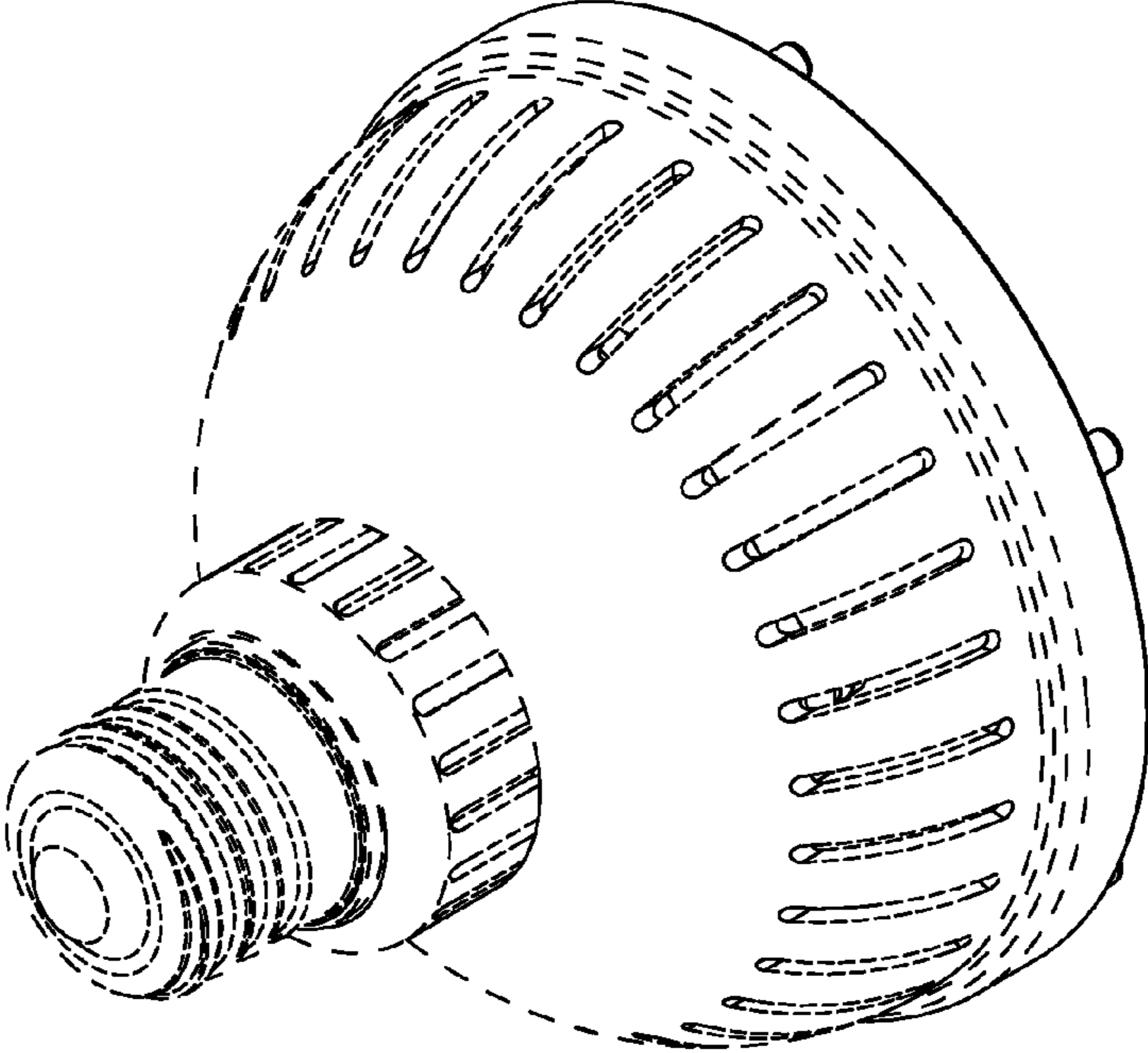

FIG. 2

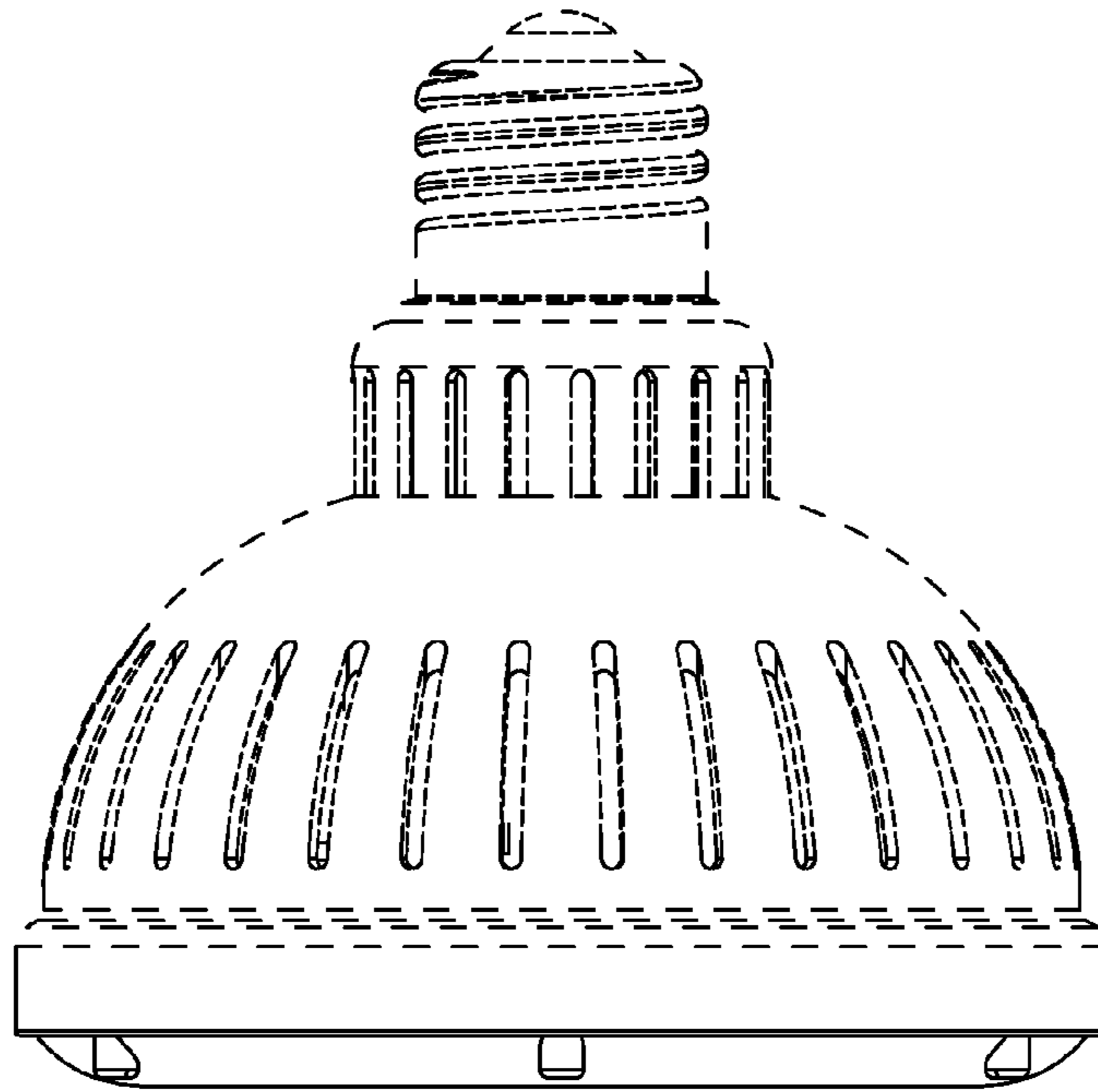

FIG. 3

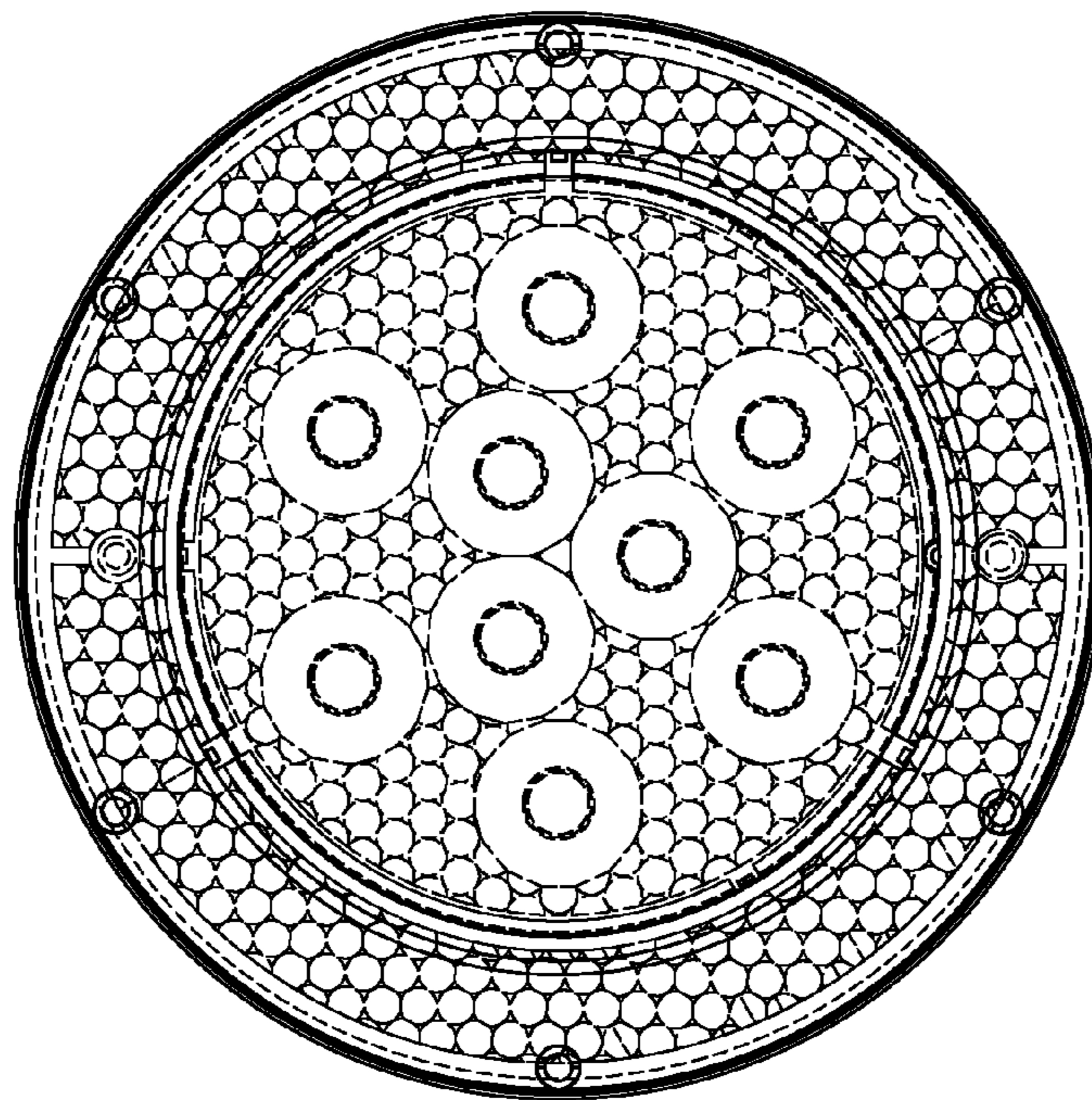

FIG. 4

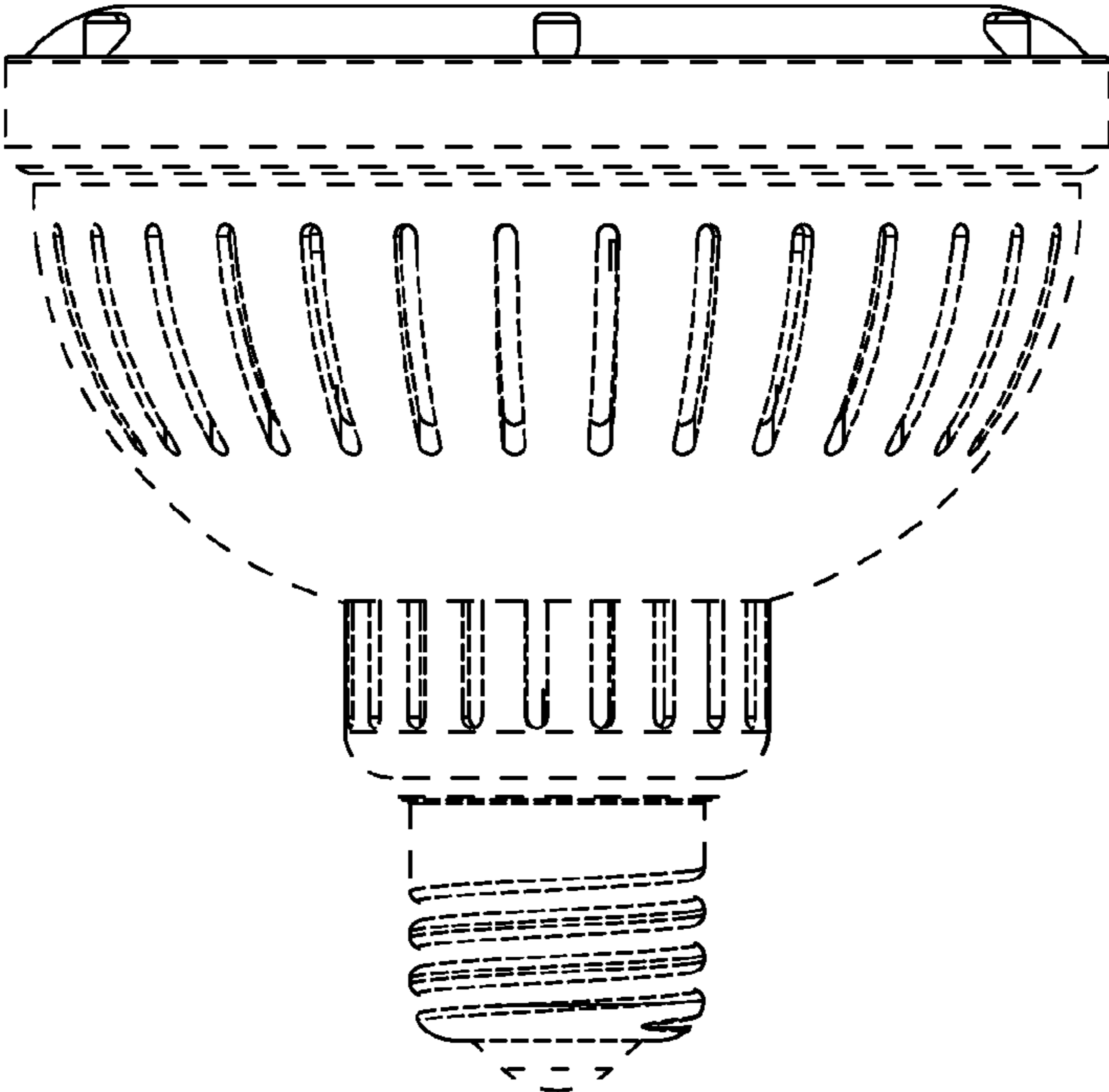

FIG. 5

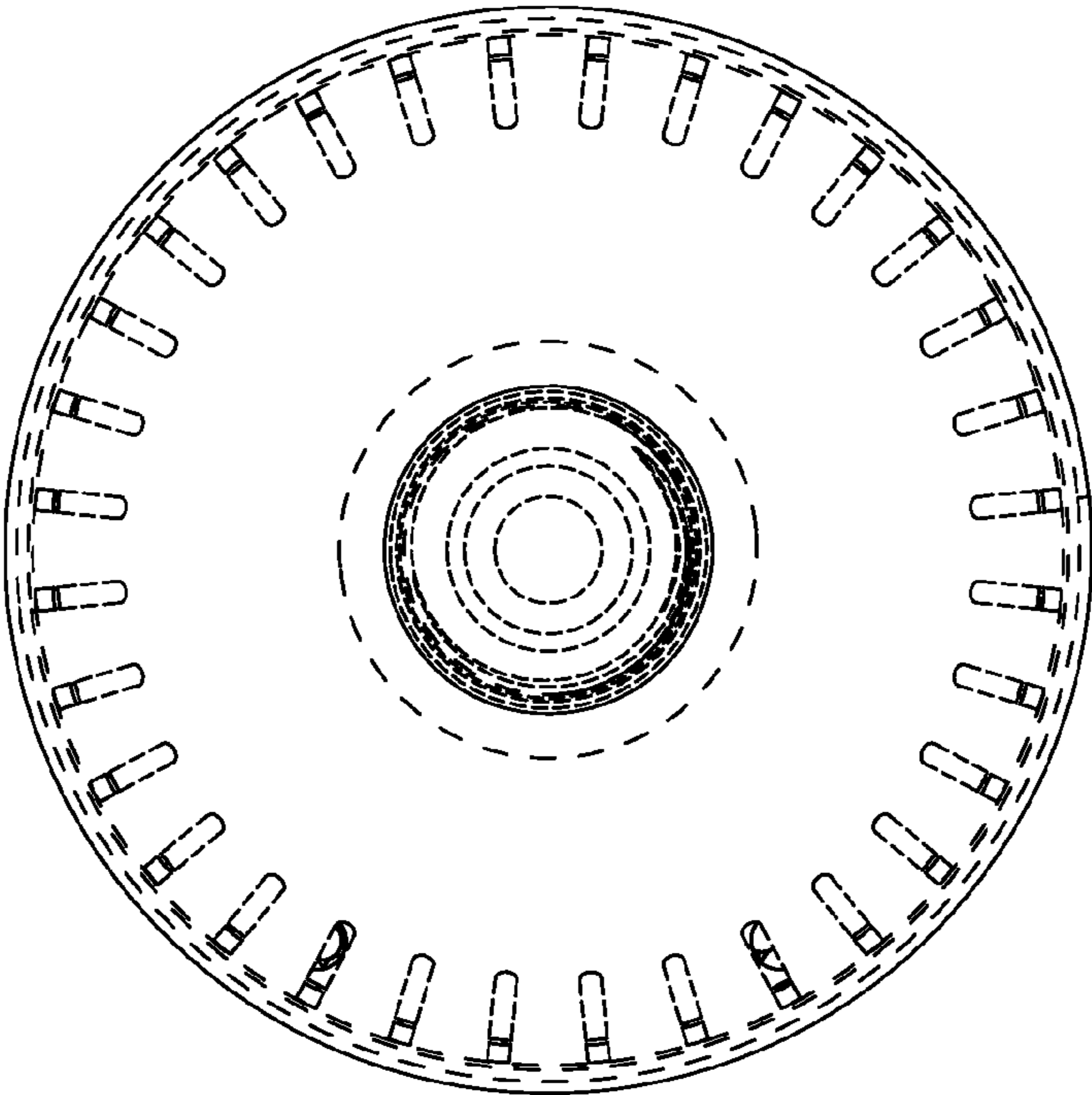

FIG. 6