



US00D636798S

(12) **United States Design Patent**  
**Fukano et al.**

(10) **Patent No.:** **US D636,798 S**  
(45) **Date of Patent:** **\*\* Apr. 26, 2011**

(54) **ELECTRIC ACTUATOR**

(75) Inventors: **Yoshihiro Fukano**, Tsukubamirai (JP);  
**Toru Sugiyama**, Tsukubamirai (JP);  
**Masaki Miyahara**, Tsukubamirai (JP)

(73) Assignee: **SMC Corporation**, Chiyoda-ku, Tokyo  
(JP)

(\*\*) Term: **14 Years**

(21) Appl. No.: **29/368,062**

(22) Filed: **Aug. 18, 2010**

(30) **Foreign Application Priority Data**

May 24, 2010 (JP) ..... 2010-012691

(51) **LOC (9) Cl.** ..... **15-09**

(52) **U.S. Cl.** ..... **D15/143**

(58) **Field of Classification Search** ..... D13/158,  
D13/162, 184; D15/5, 7, 9, 143, 148, 199;  
74/89.15, 411.5, 490.09; 297/14, 325, 327;  
310/10, 12, 15, 20, 80, 300

See application file for complete search history.

(56) **References Cited**

U.S. PATENT DOCUMENTS

D378,214 S \* 2/1997 Ikumi ..... D15/7  
D399,491 S \* 10/1998 Nagai et al. .... D13/158  
D399,830 S \* 10/1998 Nagai et al. .... D13/158  
D413,129 S \* 8/1999 Nagai et al. .... D15/199  
6,344,718 B1 \* 2/2002 Nagai et al. .... 318/14  
D480,405 S \* 10/2003 Kleffmann et al. .... D15/143

D596,653 S \* 7/2009 Fukano et al. .... D15/143  
D611,514 S \* 3/2010 Fukano et al. .... D15/143  
D624,098 S \* 9/2010 Fukano et al. .... D15/143  
D624,572 S \* 9/2010 Fukano et al. .... D15/143  
2009/0260463 A1 \* 10/2009 Fukano et al. .... 74/89.33

\* cited by examiner

*Primary Examiner* — Patricia Palasik

(74) *Attorney, Agent, or Firm* — Yokoi & Co., U.S.A., Inc.;  
Toshiyuki Yokoi

(57) **CLAIM**

The ornamental design for an electric actuator, as shown and described.

**DESCRIPTION**

FIG. 1 shows a front view of an electric actuator showing my new design;  
FIG. 2 shows a rear view thereof;  
FIG. 3 shows a right side view thereof;  
FIG. 4 shows a left side view thereof;  
FIG. 5 shows a top view thereof;  
FIG. 6 shows a bottom view thereof;  
FIG. 7 shows a top, front and left side perspective view thereof; and,  
FIG. 8 shows a top, front and right side perspective view thereof.

The broken lines in the drawings depict unclaimed environmental subject matter.

**1 Claim, 5 Drawing Sheets**

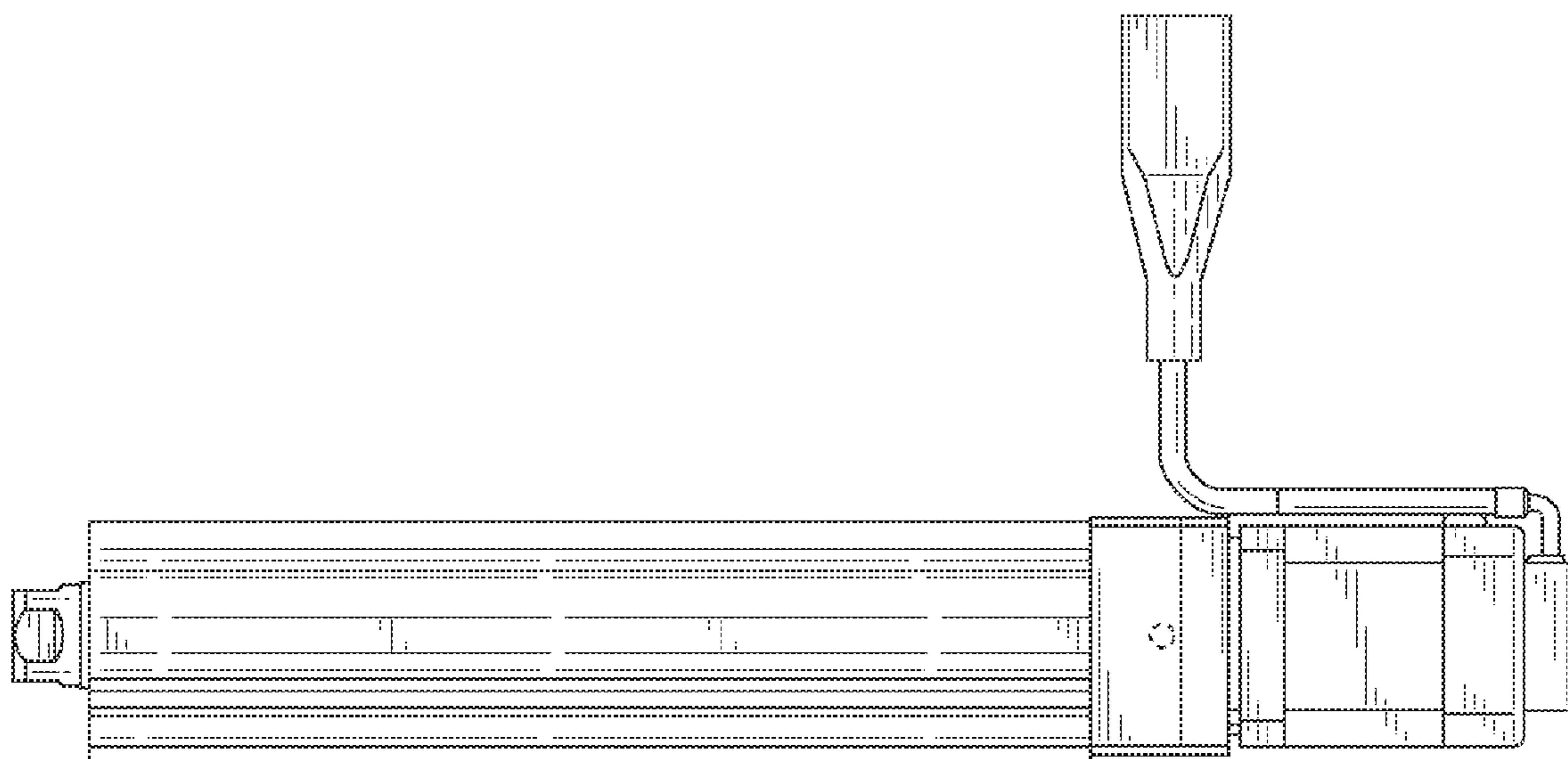

FIG. 1

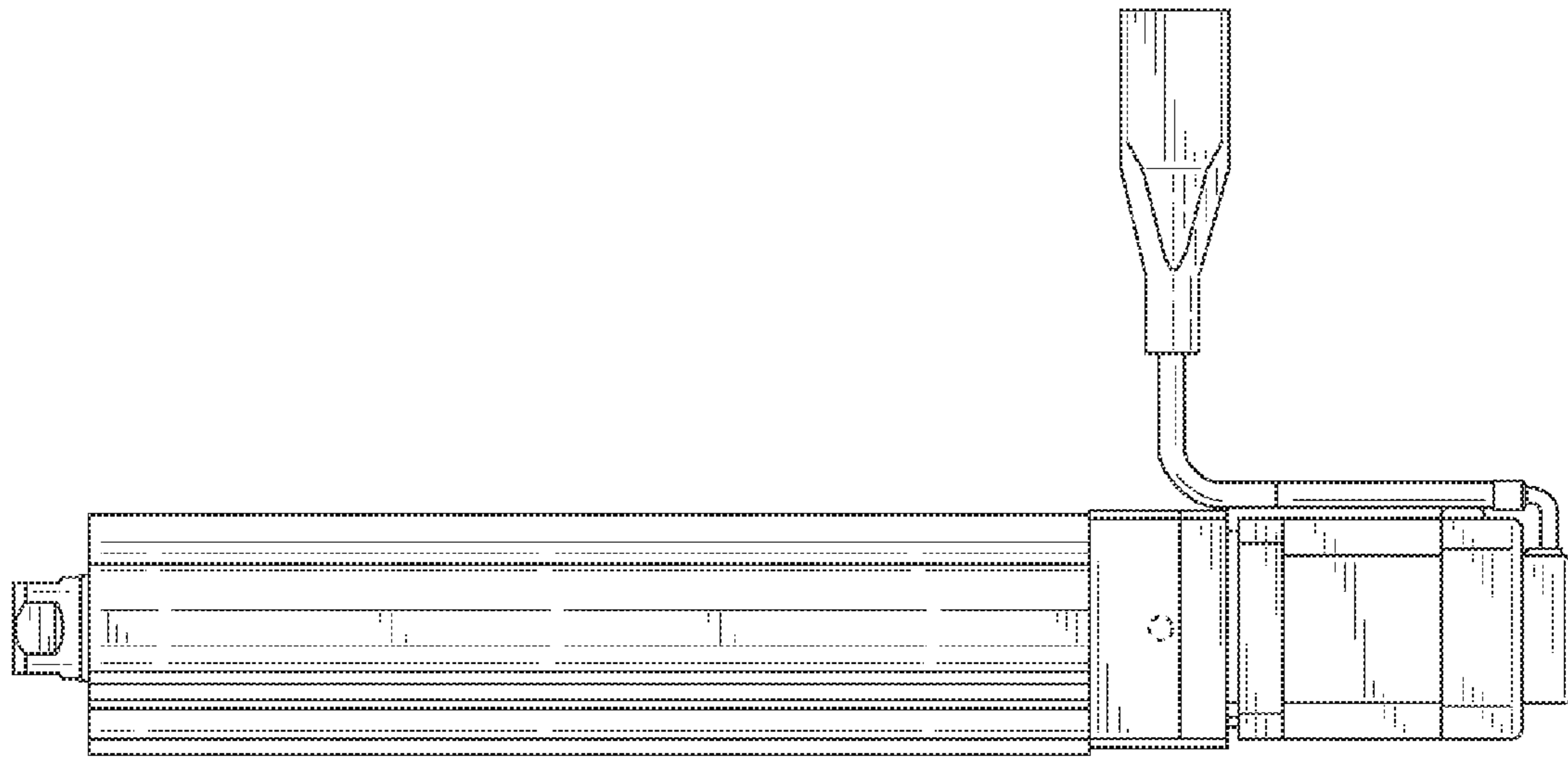

FIG. 2

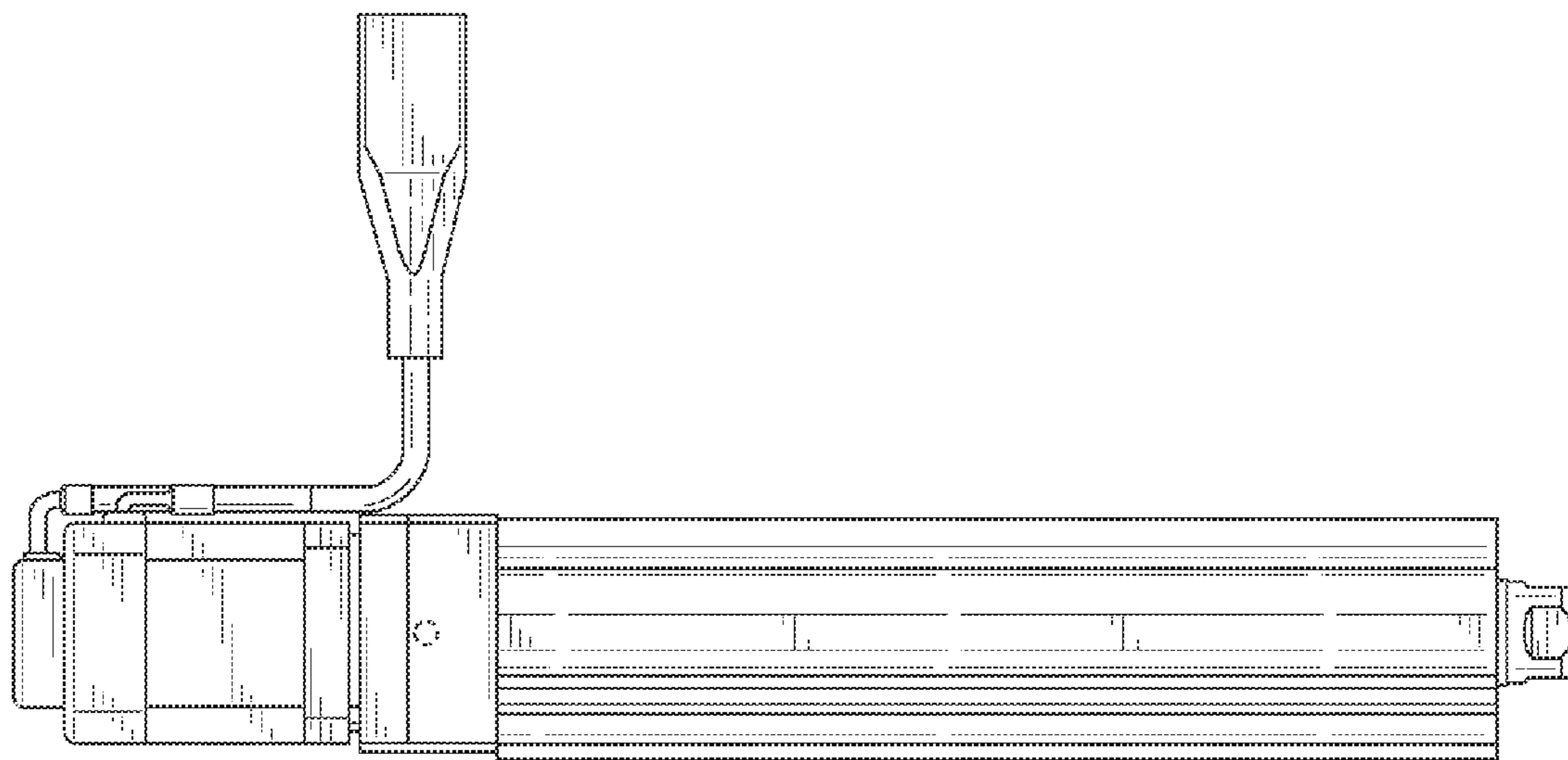

FIG. 3

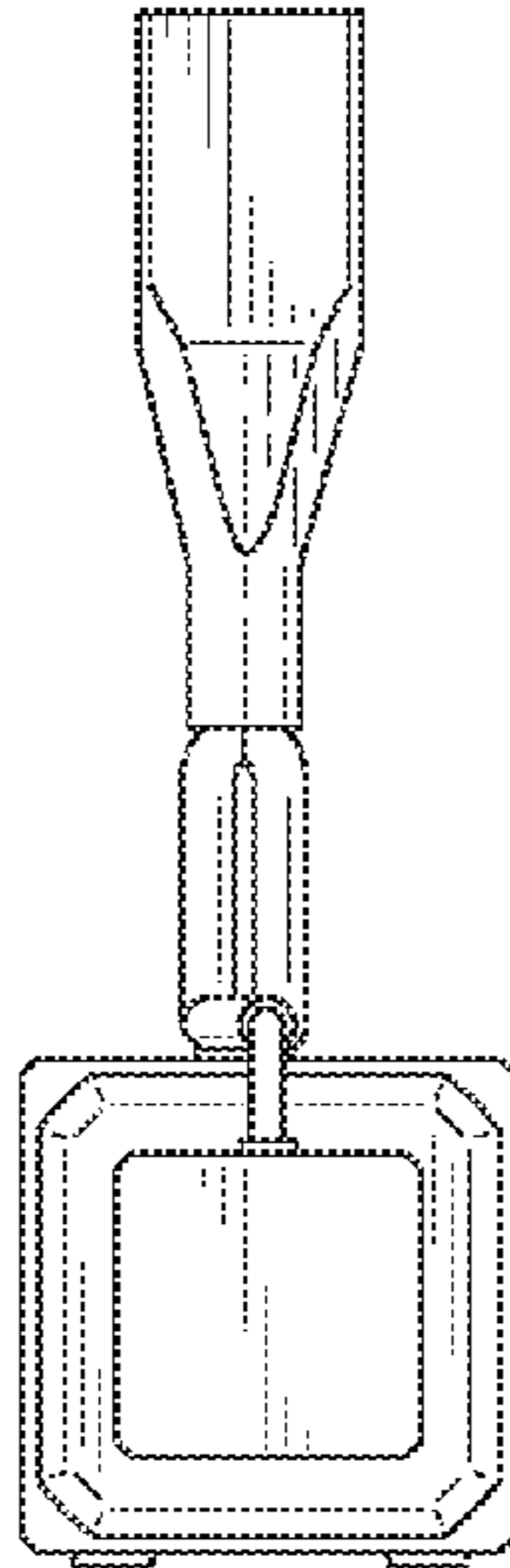

FIG. 4

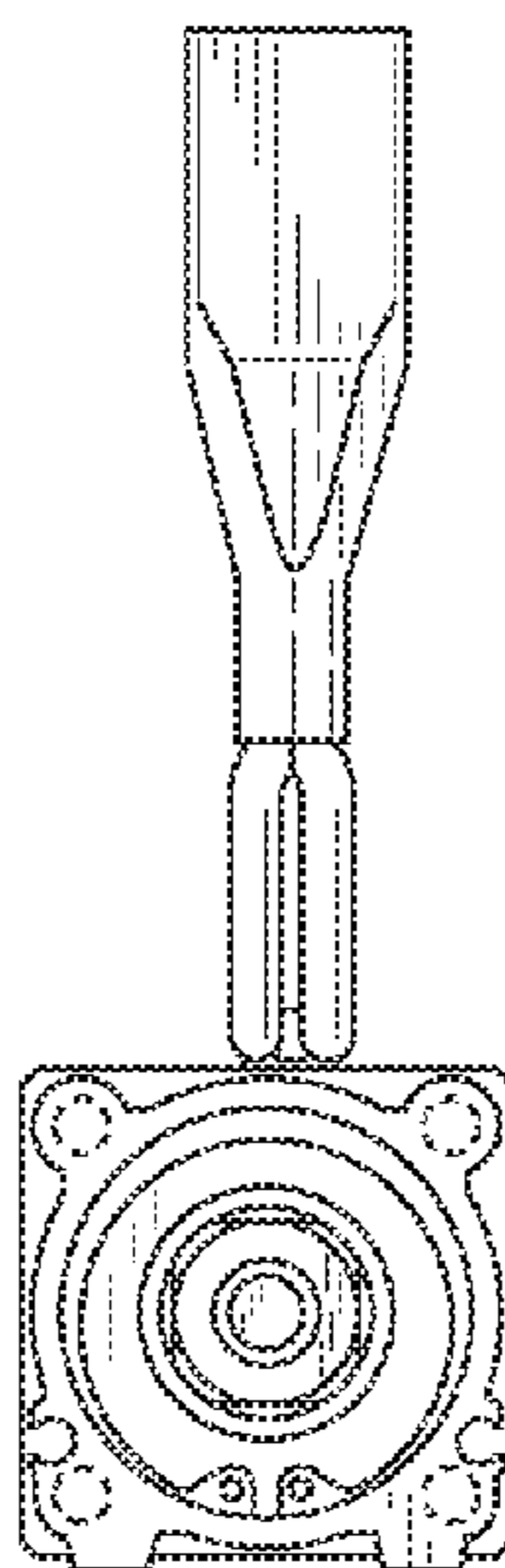

FIG. 5

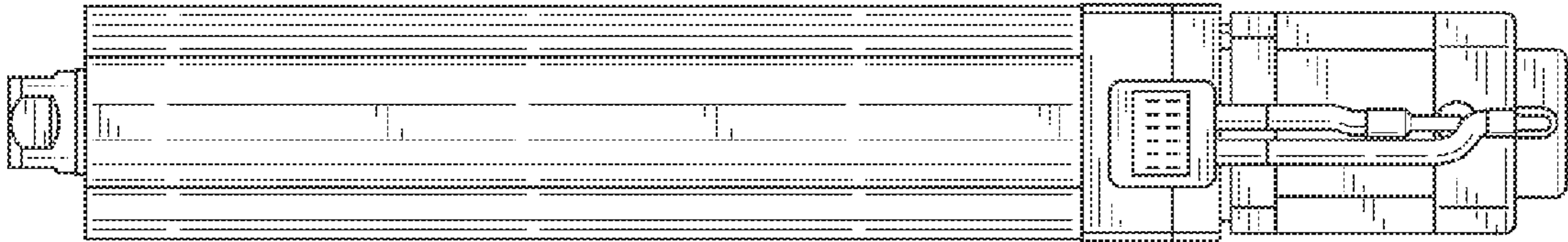

FIG. 6

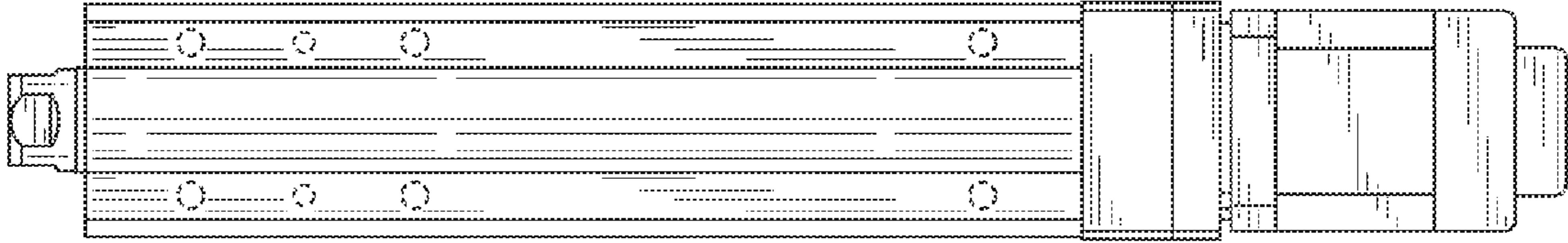

FIG. 7

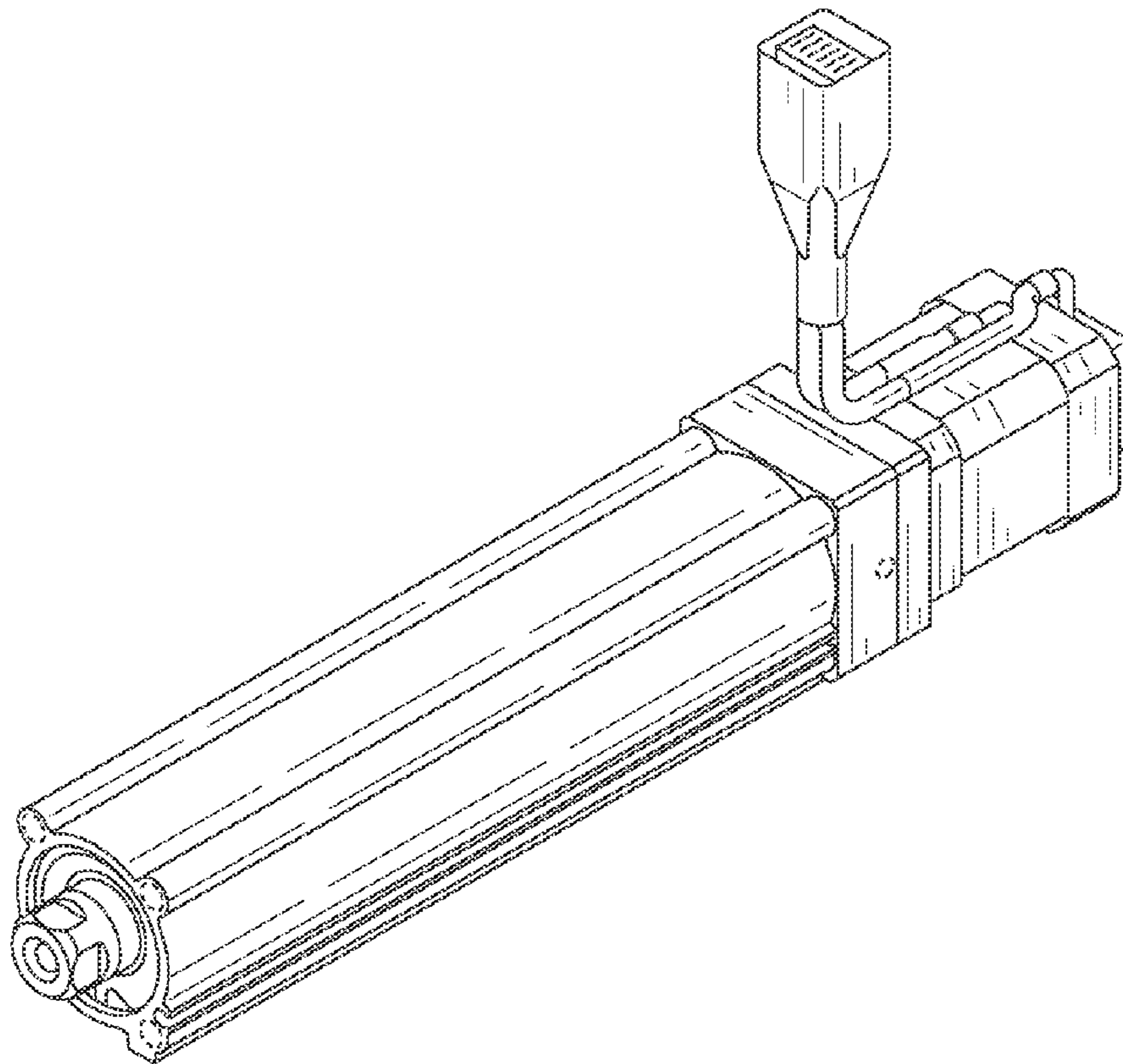

FIG. 8

