



US00D636678S

(12) **United States Design Patent**
Baird et al.

(10) **Patent No.:** **US D636,678 S**

(45) **Date of Patent:** **** Apr. 26, 2011**

(54) **CONICAL CENTRIFUGE BOTTLE**

(75) Inventors: **Peter Kevin Baird**, Honeoye Falls, NY (US); **Keith Owen Whittlinger**, Penfield, NY (US)

(73) Assignee: **Nalge Nunc International Corporation**, Rochester, NY (US)

(**) Term: **14 Years**

(21) Appl. No.: **29/381,183**

(22) Filed: **Dec. 16, 2010**

Related U.S. Application Data

(62) Division of application No. 29/357,201, filed on Mar. 9, 2010.

(51) **LOC (9) Cl.** **09-01**

(52) **U.S. Cl.** **D9/500; D9/521; D9/547; D24/224**

(58) **Field of Classification Search** D9/500, D9/502-505, 516, 521, 545, 547, 549, 558, D9/690-691, 778; D10/101, 107; D24/219, D24/224

See application file for complete search history.

(56) **References Cited**

U.S. PATENT DOCUMENTS

D42,287 S *	3/1912	Ingram	D9/521
D47,278 S	4/1915	Weicker		
D53,909 S *	10/1919	Hitzeman	D9/521
D63,796 S	1/1924	Mulholland		
1,879,820 A	9/1932	Perry		
D207,924 S *	6/1967	Revillon	D9/503
3,342,379 A *	9/1967	Foley	222/173
D209,951 S	1/1968	Smith		
D212,585 S	11/1968	Joy		
D213,897 S	4/1969	Swampscott		
D232,355 S *	8/1974	Wiedmann	D24/224
D244,562 S *	5/1977	Hagglund et al.	D9/558 X
D247,578 S	3/1978	Sponseller		
D255,492 S *	6/1980	Meierhoefer	D24/117
D258,534 S	3/1981	Nagel		
D265,549 S *	7/1982	Houts et al.	D9/521 X
D286,468 S	11/1986	Fuchs		

D302,722 S	8/1989	Baxter		
D304,997 S	12/1989	Baxter		
D307,052 S *	4/1990	Baxter	D24/224
D312,128 S	11/1990	Headley		
D319,407 S	8/1991	Paulovitz et al.		
D340,993 S	11/1993	Bellotti		
D345,114 S *	3/1994	Puls	D10/101
5,382,409 A	1/1995	Baxter		
D355,604 S *	2/1995	De Baschmakoff	D9/545 X
D357,645 S	4/1995	Wang		
D358,468 S	5/1995	Howard		

(Continued)

Primary Examiner — Carol Rademaker

(74) *Attorney, Agent, or Firm* — Wood, Herron & Evans, LLP

(57) **CLAIM**

The ornamental design for a conical centrifuge bottle, as shown and described.

DESCRIPTION

FIG. 1 is a top, front, and left side isometric view of our new conical centrifuge bottle, shown with unclaimed environment of a cap and measurement markings;

FIG. 2 is a front elevational view thereof;

FIG. 3 is a top, front, and left side isometric view of the conical centrifuge bottle of FIG. 1, shown with the unclaimed environment removed;

FIG. 4 is a front elevational view thereof;

FIG. 5 is a right side elevational view thereof;

FIG. 6 is a rear elevational view thereof;

FIG. 7 is a left side elevational view thereof;

FIG. 8 is a cross-sectional view taken along section line 8—8 in FIG. 3;

FIG. 9 is a top plan view of the conical centrifuge bottle of FIG. 3; and,

FIG. 10 is a bottom plan view thereof.

The broken line showing of a cap and of measurement markings in drawing FIGS. 1 & 2 is included for the purpose of illustrating environmental structure and forms no part of the claimed design.

1 Claim, 3 Drawing Sheets

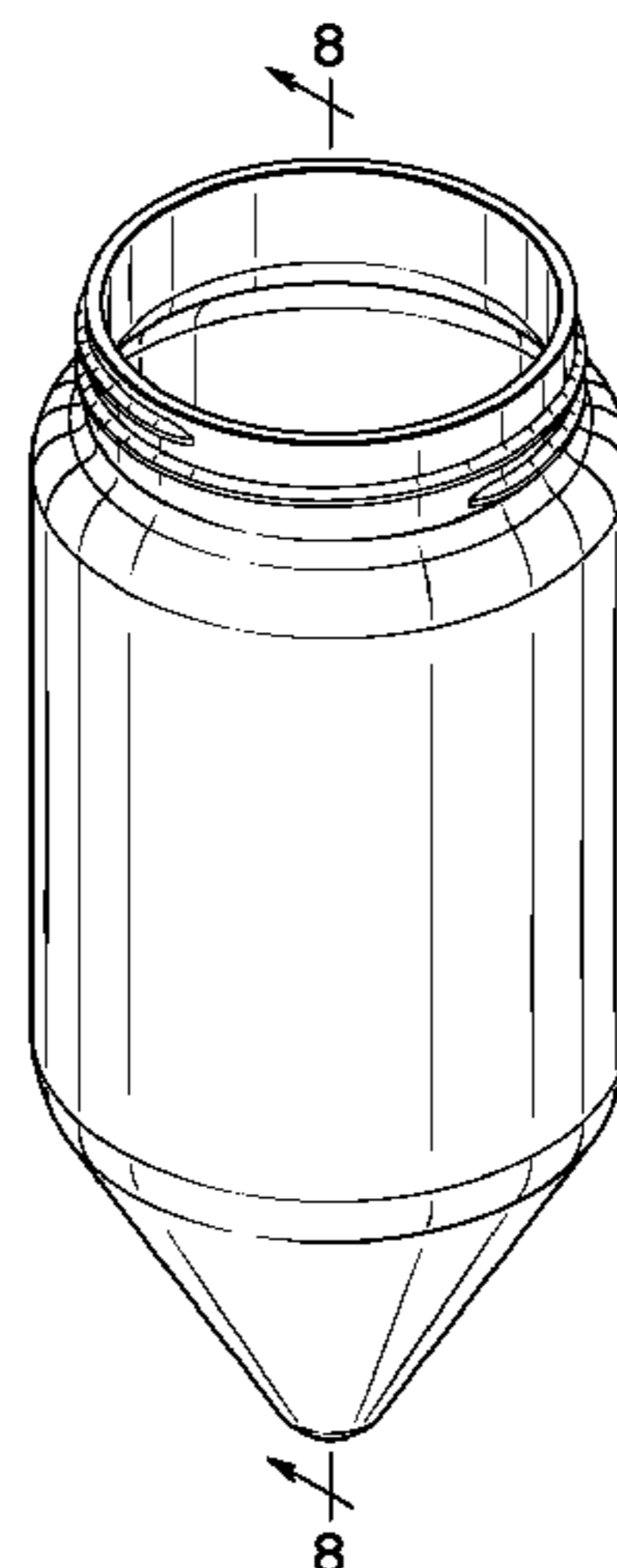
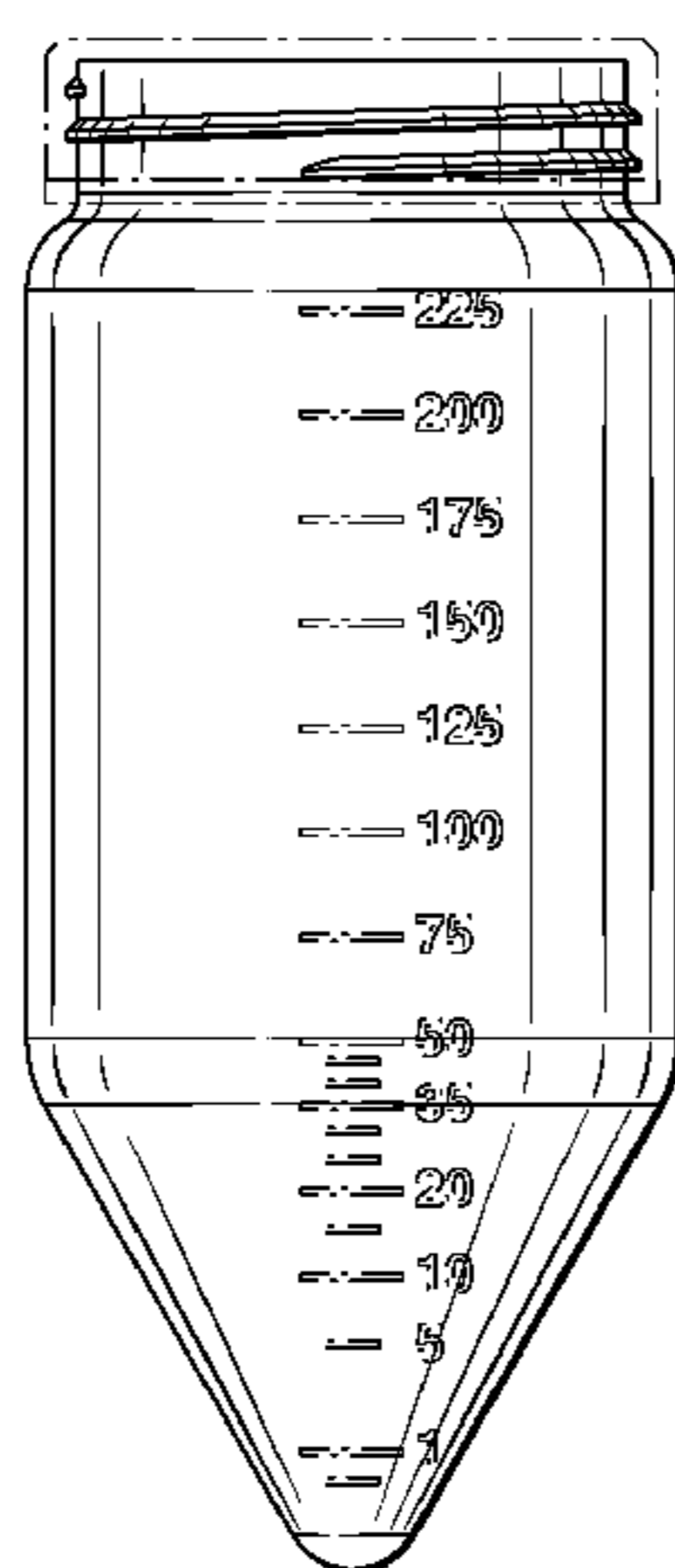

US D636,678 S

Page 2

U.S. PATENT DOCUMENTS

D363,985	S	*	11/1995	Van Hovel et al.	D24/111	D453,837	S		2/2002	Lodge	
5,470,537	A		11/1995	Siegel		D492,603	S	*	7/2004	Rashid	D9/521
D377,586	S		1/1997	McBride		D517,919	S		3/2006	Walters	
D395,239	S	*	6/1998	Davis	D9/778	D567,660	S	*	4/2008	Gautier	D9/545 X
D401,115	S		11/1998	Huang		D589,805	S	*	4/2009	Kunesh et al.	D9/521
D402,545	S	*	12/1998	Kerdoon et al.	D9/601	D602,785	S	*	10/2009	Rothberg et al.	D9/547 X
D447,419	S		9/2001	Jaketic		D607,731	S	*	1/2010	Soliman	D9/558 X
D453,573	S		2/2002	Lafond et al.		D615,866	S	*	5/2010	Lepoitevin	D9/504 X

* cited by examiner

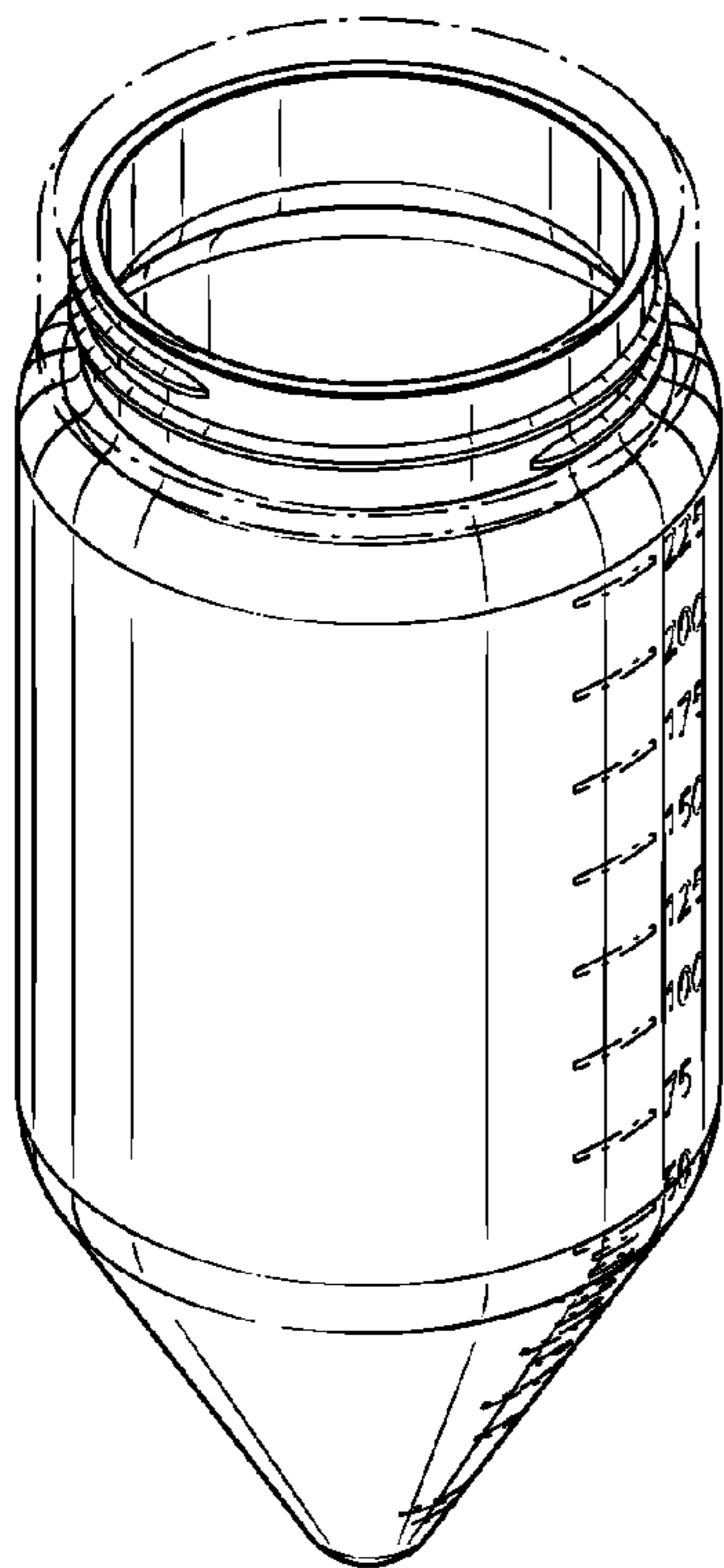

FIG. 1

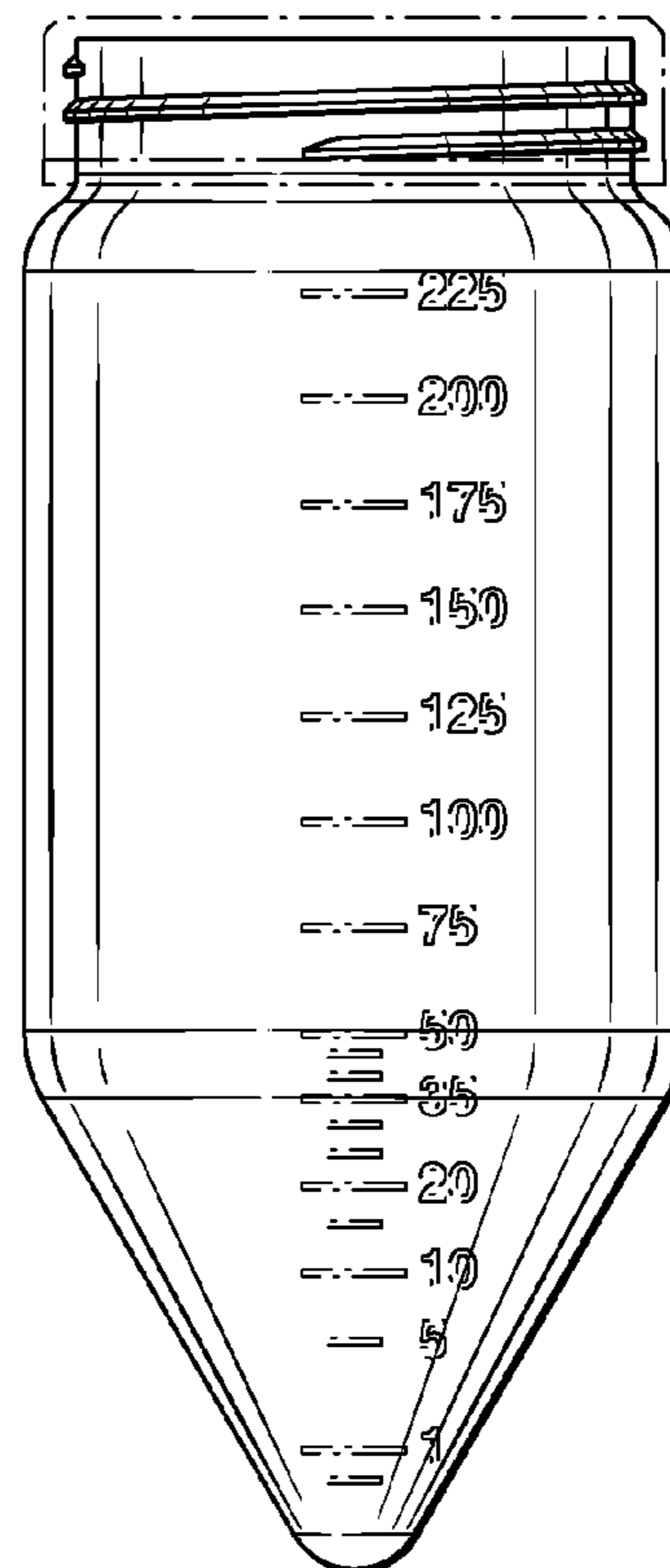

FIG. 2

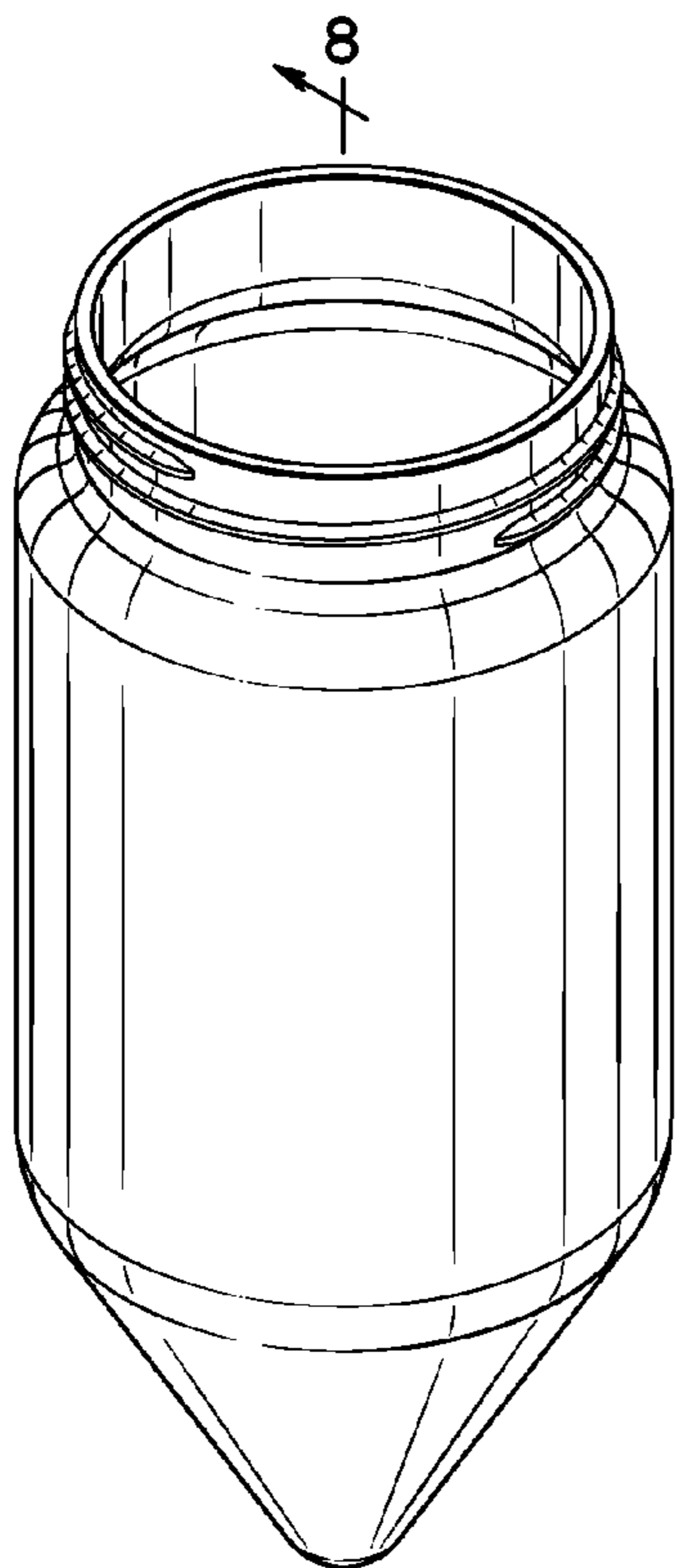

FIG. 3

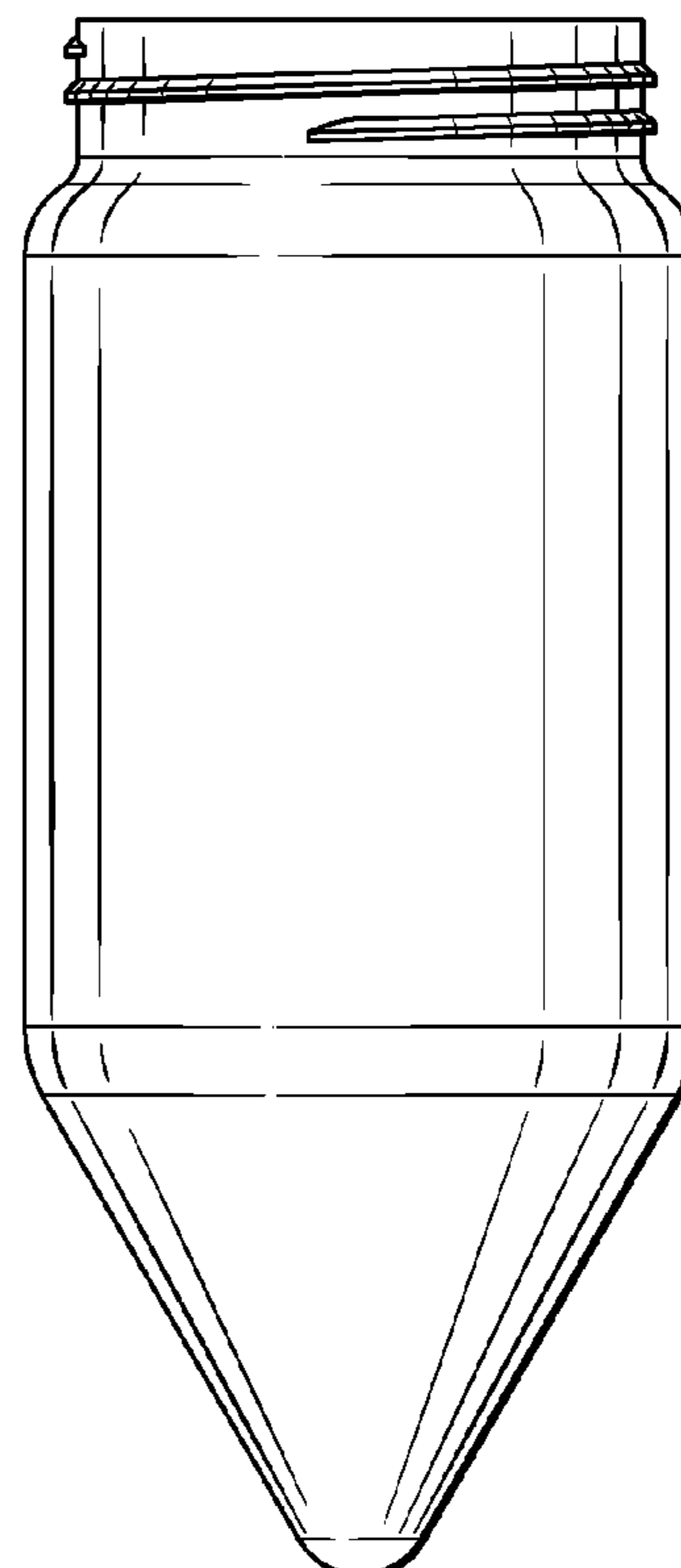

FIG. 4

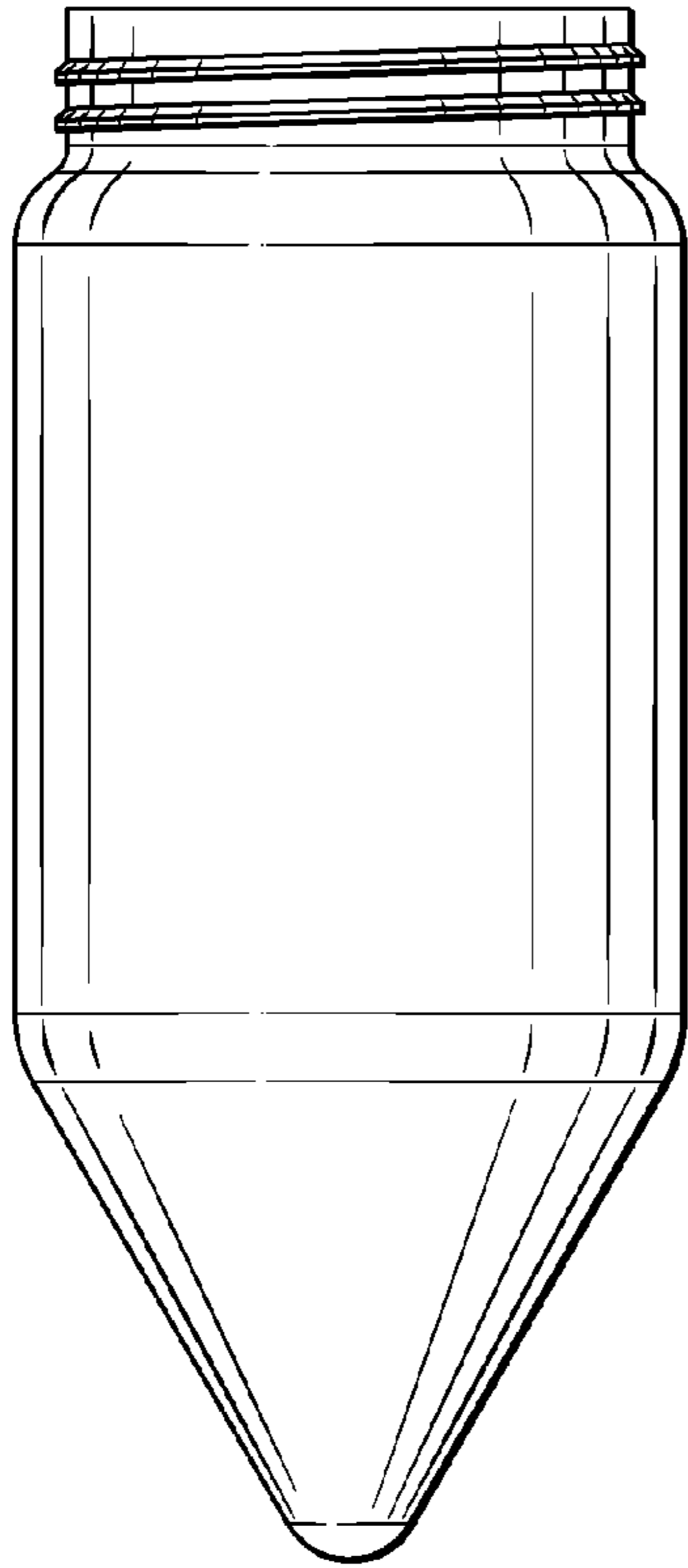

FIG. 5

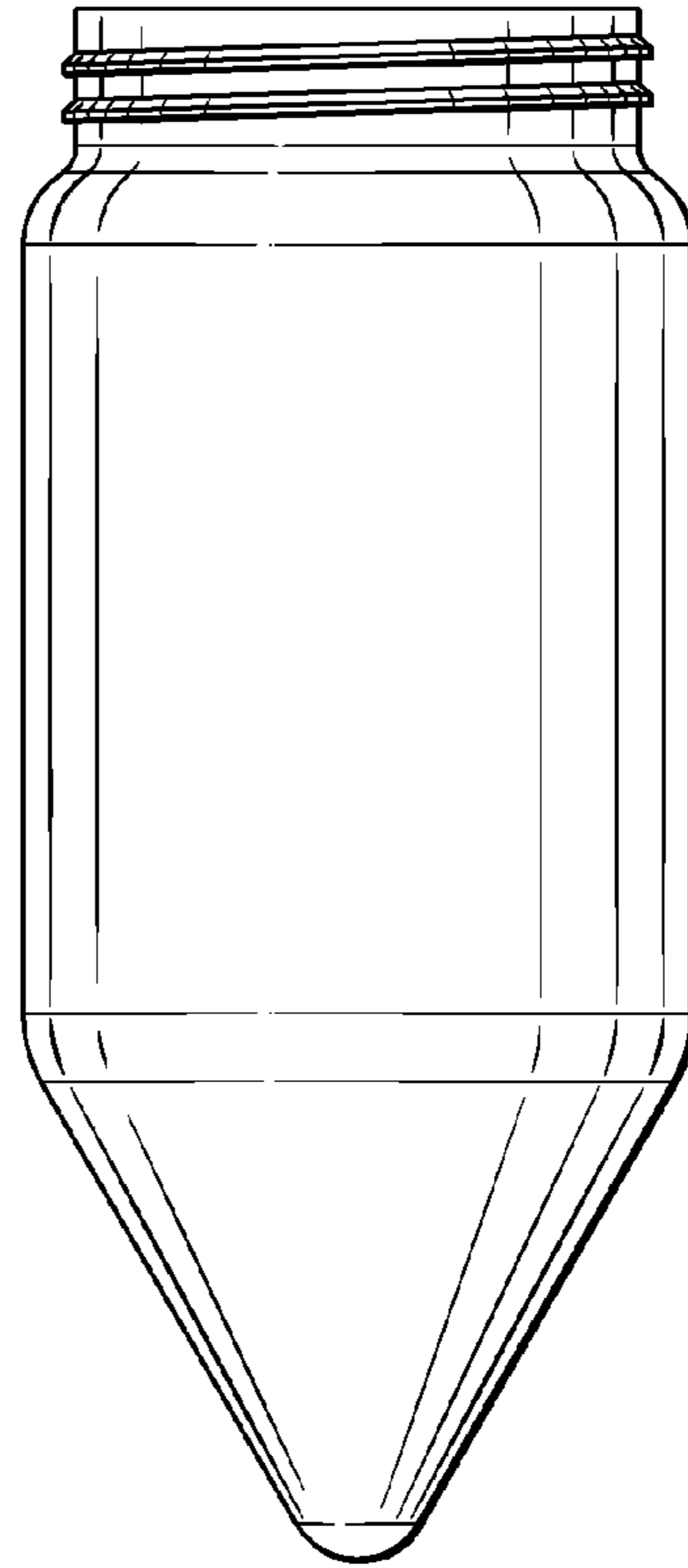

FIG. 6

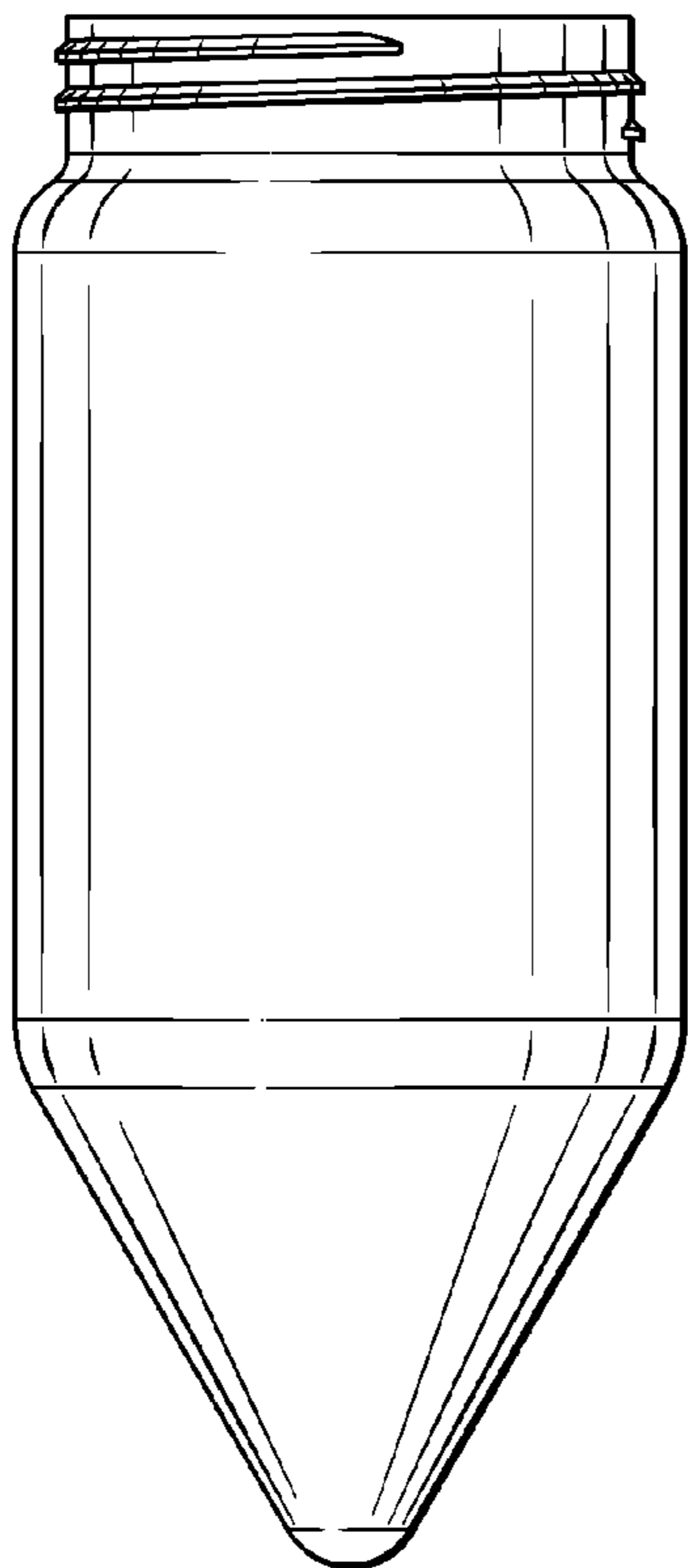

FIG. 7

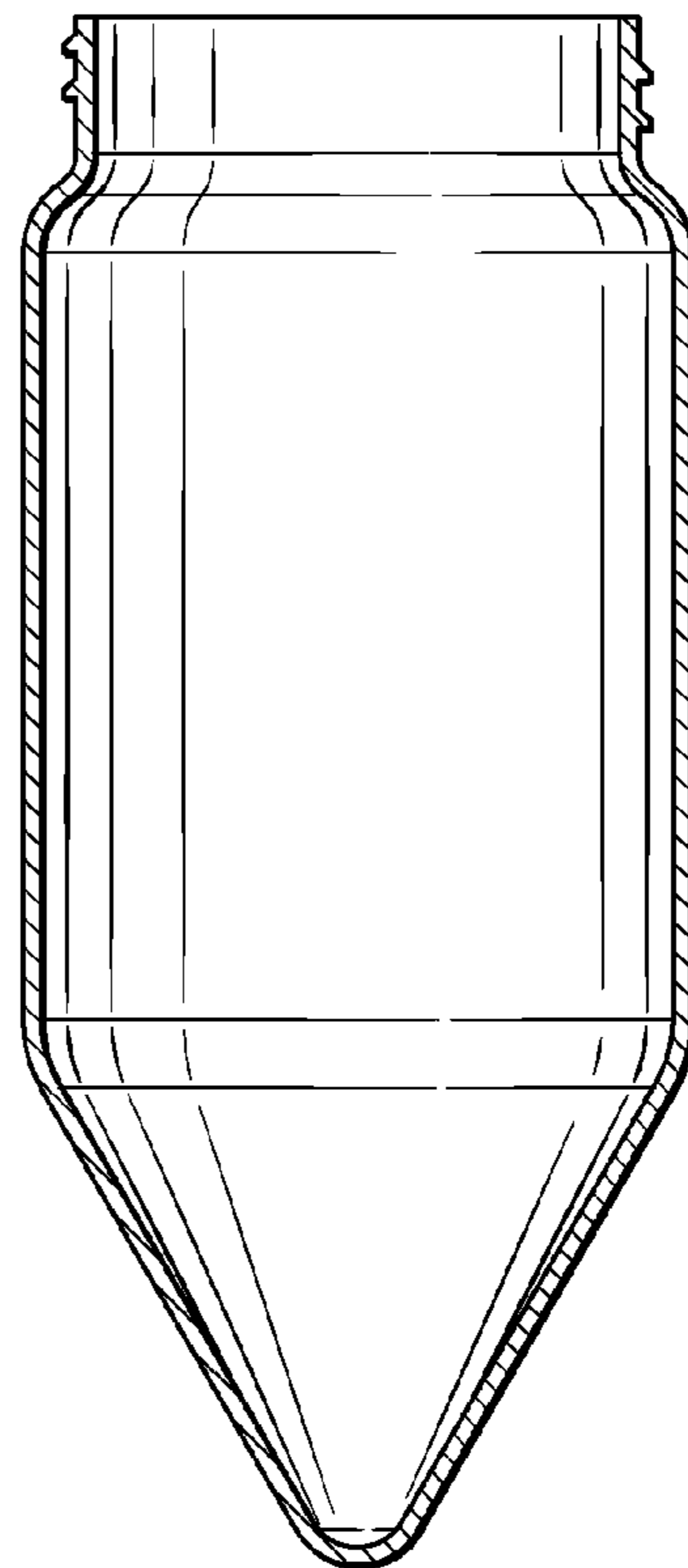

FIG. 8

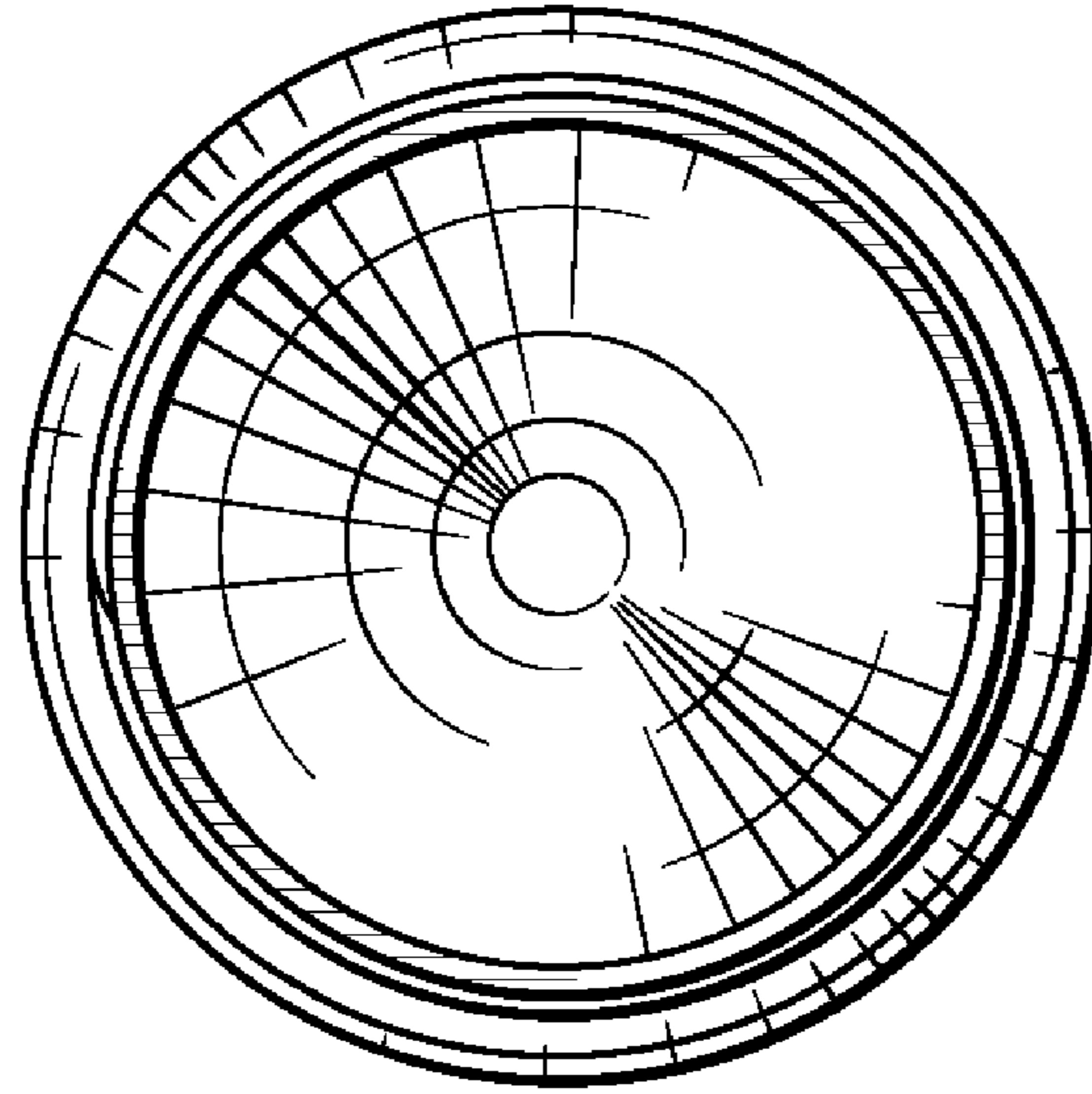

FIG. 9

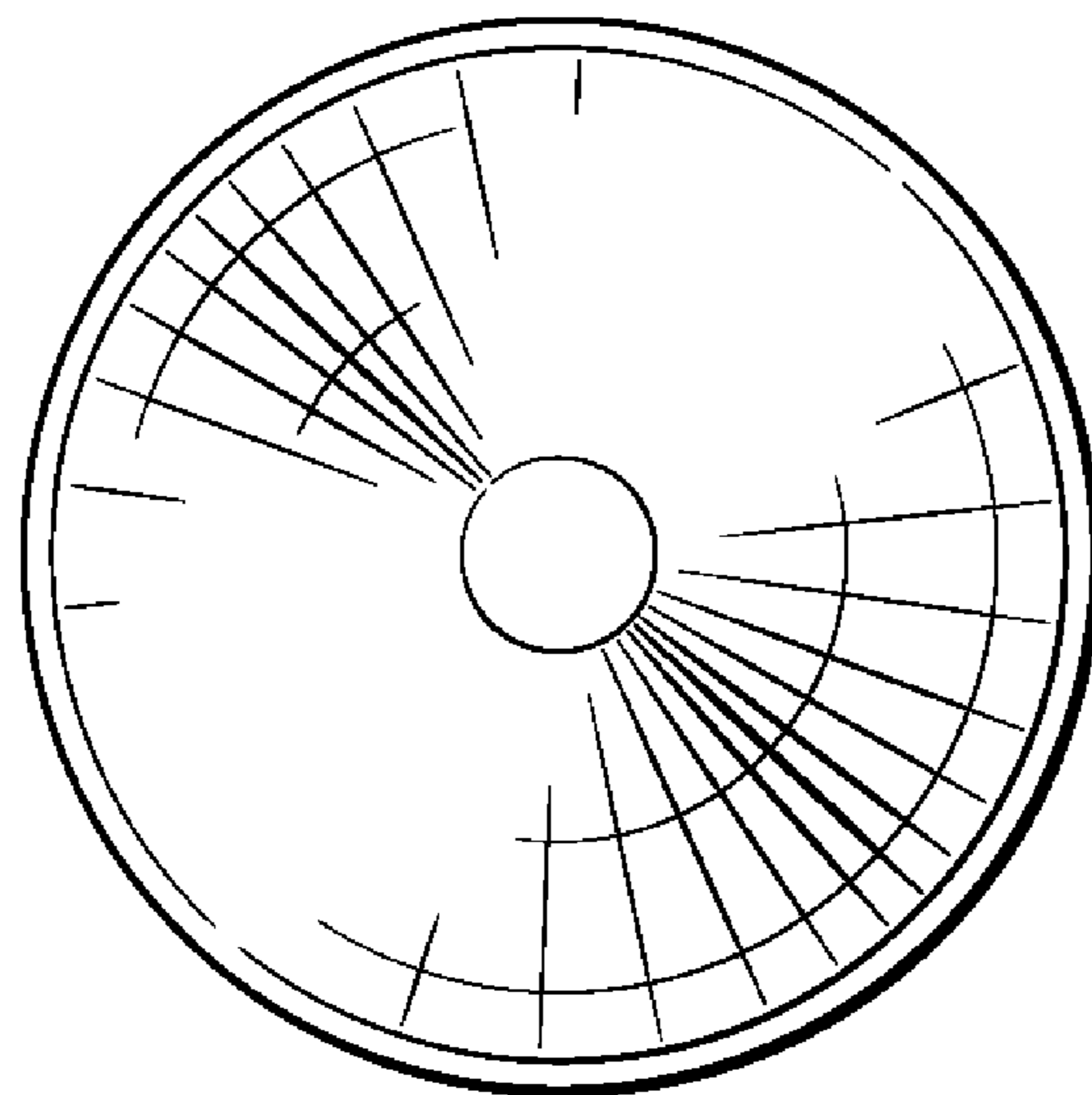

FIG. 10