



US00D636643S

(12) **United States Design Patent**
Tiemann

(10) **Patent No.:** **US D636,643 S**
(45) **Date of Patent:** **** Apr. 26, 2011**

(54) **CAROUSEL USED IN DRYING AND DISPLAYING COLORED EGGS**
(75) Inventor: **Frank R. Tiemann**, Madison Lake, MN (US)

(73) Assignee: **Nifty Home Products, Inc.**, Madison Lake, MN (US)

(**) Term: **14 Years**

(21) Appl. No.: **29/367,943**

(22) Filed: **Aug. 16, 2010**

(51) **LOC (9) Cl.** **06-04**

(52) **U.S. Cl.** **D7/702; D7/600.4; D7/611**

(58) **Field of Classification Search** D7/600.1–600.4, D7/701–708, 611; D6/462–469, 514, 449; 211/71.01, 70.6, 70.7, 77, 78, 74, 85.31, 211/181.1, 119.12, 128.1, 133.2
See application file for complete search history.

(56) **References Cited**

U.S. PATENT DOCUMENTS

D386,363 S *	11/1997	Dardashti	D7/704
D516,385 S *	3/2006	Franczyk	D7/704
D536,936 S *	2/2007	Tiemann	D7/704
D544,308 S *	6/2007	Tiemann	D7/590

D558,529 S *	1/2008	McDavitt et al.	D7/704
D558,530 S *	1/2008	McDavitt et al.	D7/610
D586,185 S *	2/2009	Tiemann	D7/600.2
D609,057 S *	2/2010	Hertaus	D7/600.2
D609,533 S *	2/2010	Tiemann	D7/600.2
D617,124 S	6/2010	Snider		
D621,640 S	8/2010	Tiemann		
D626,382 S	11/2010	Tiemann		
2007/0045206 A1 *	3/2007	Tiemann	211/77

* cited by examiner

Primary Examiner — Terry A Wallace

(74) *Attorney, Agent, or Firm* — Thomas J. Nikolai; Nikolai & Mersereau, P.A.

(57) **CLAIM**

The ornamental design for the “carousel used in drying and displaying colored eggs,” as shown and described.

DESCRIPTION

FIG. 1 is a perspective view of the carousel used in drying and displaying colored eggs;
FIG. 2 is a front view thereof;
FIG. 3 is a side view thereof;
FIG. 4 is a back view thereof;
FIG. 5 is a second side view thereof;
FIG. 6 is a top view thereof; and,
FIG. 7 is a bottom view thereof.

1 Claim, 6 Drawing Sheets

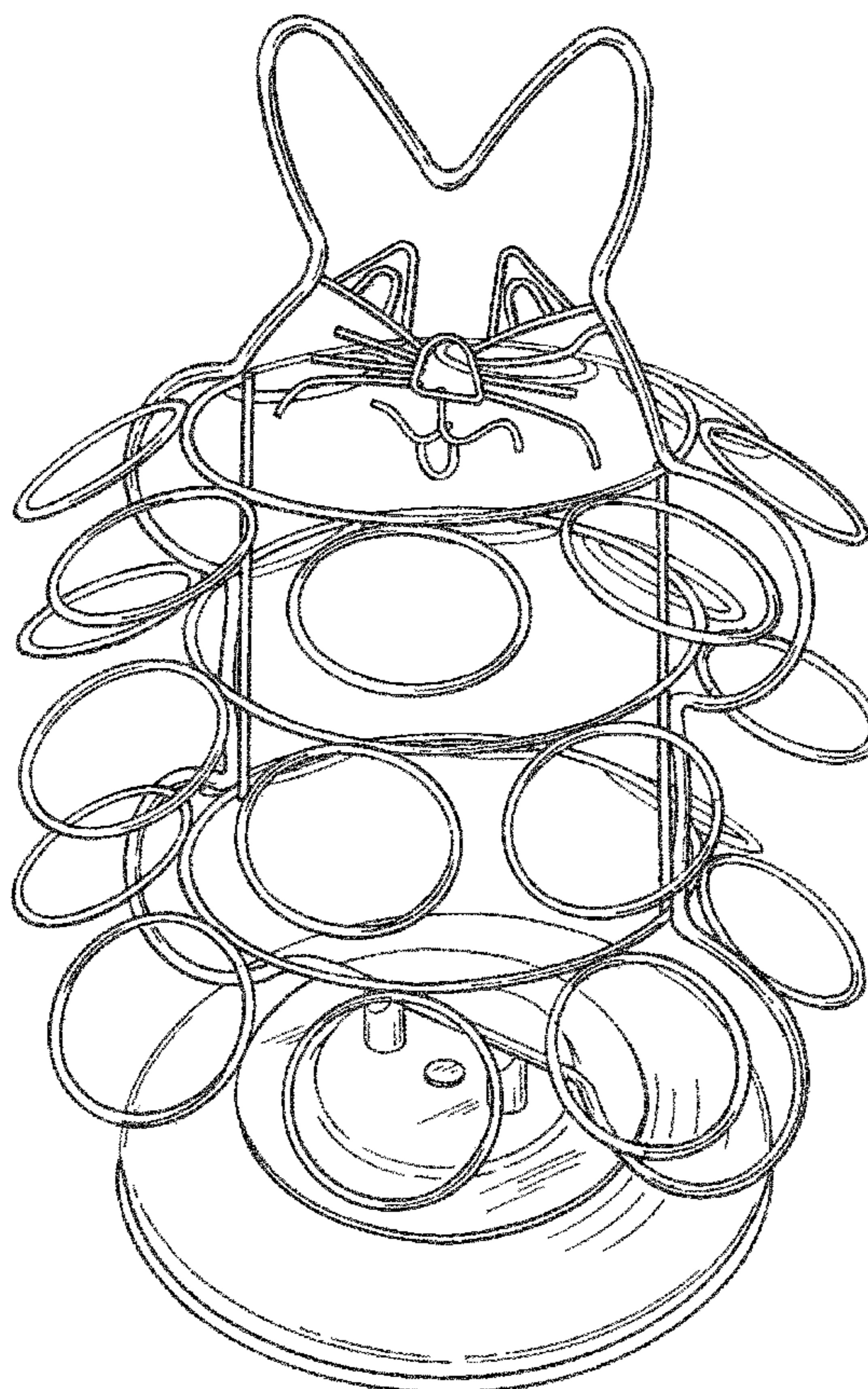

FIG. 1

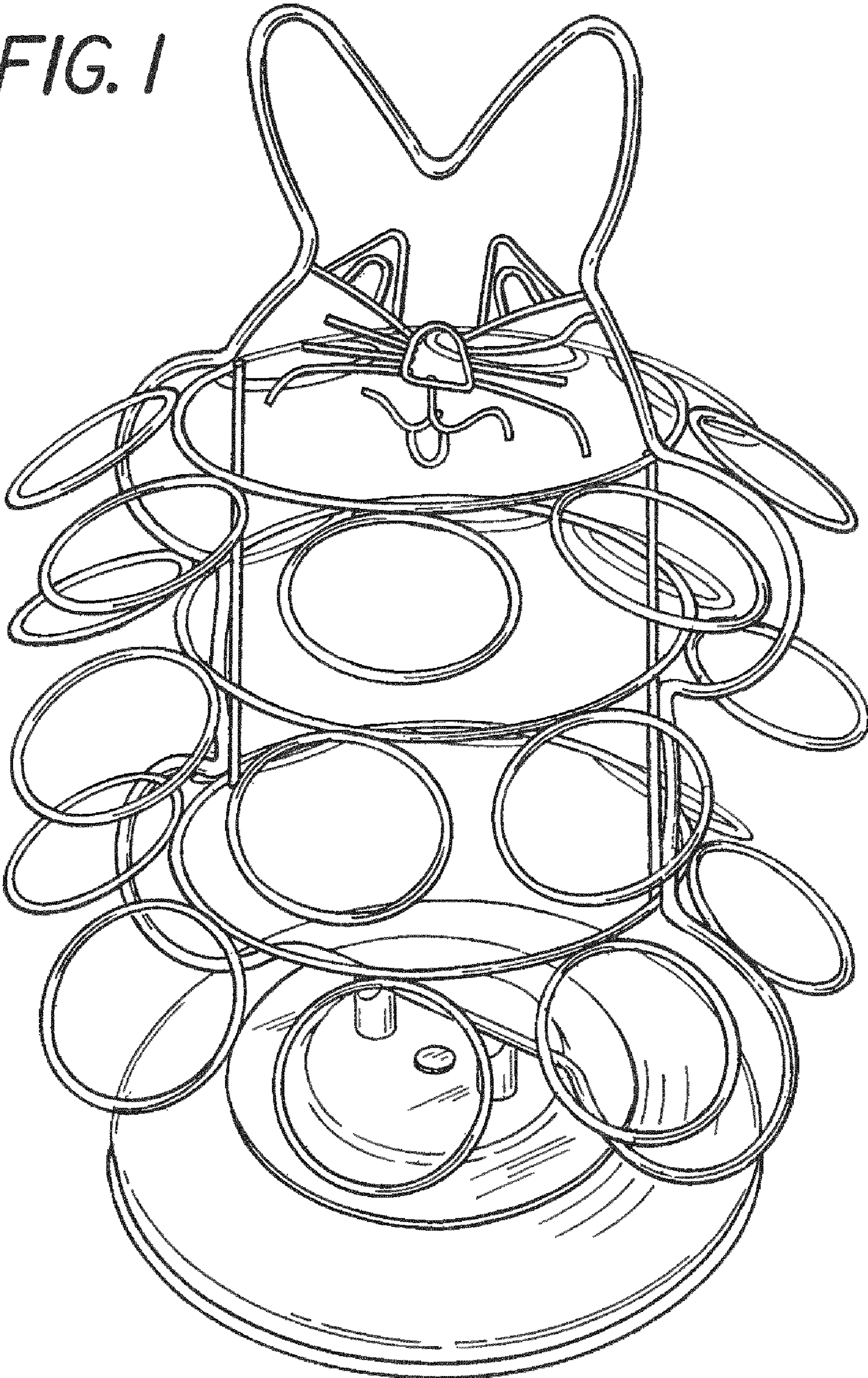

FIG. 2

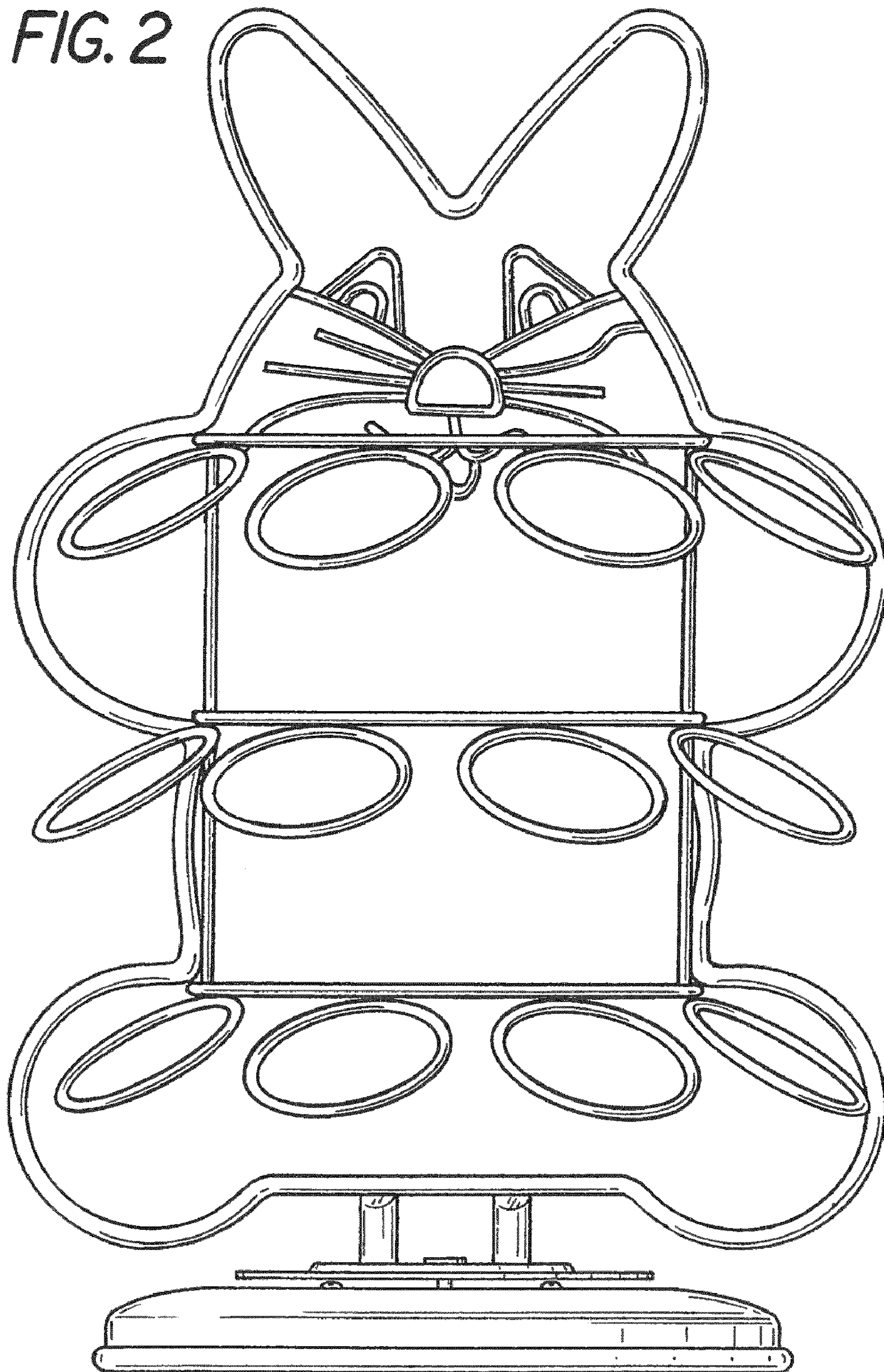

FIG. 3

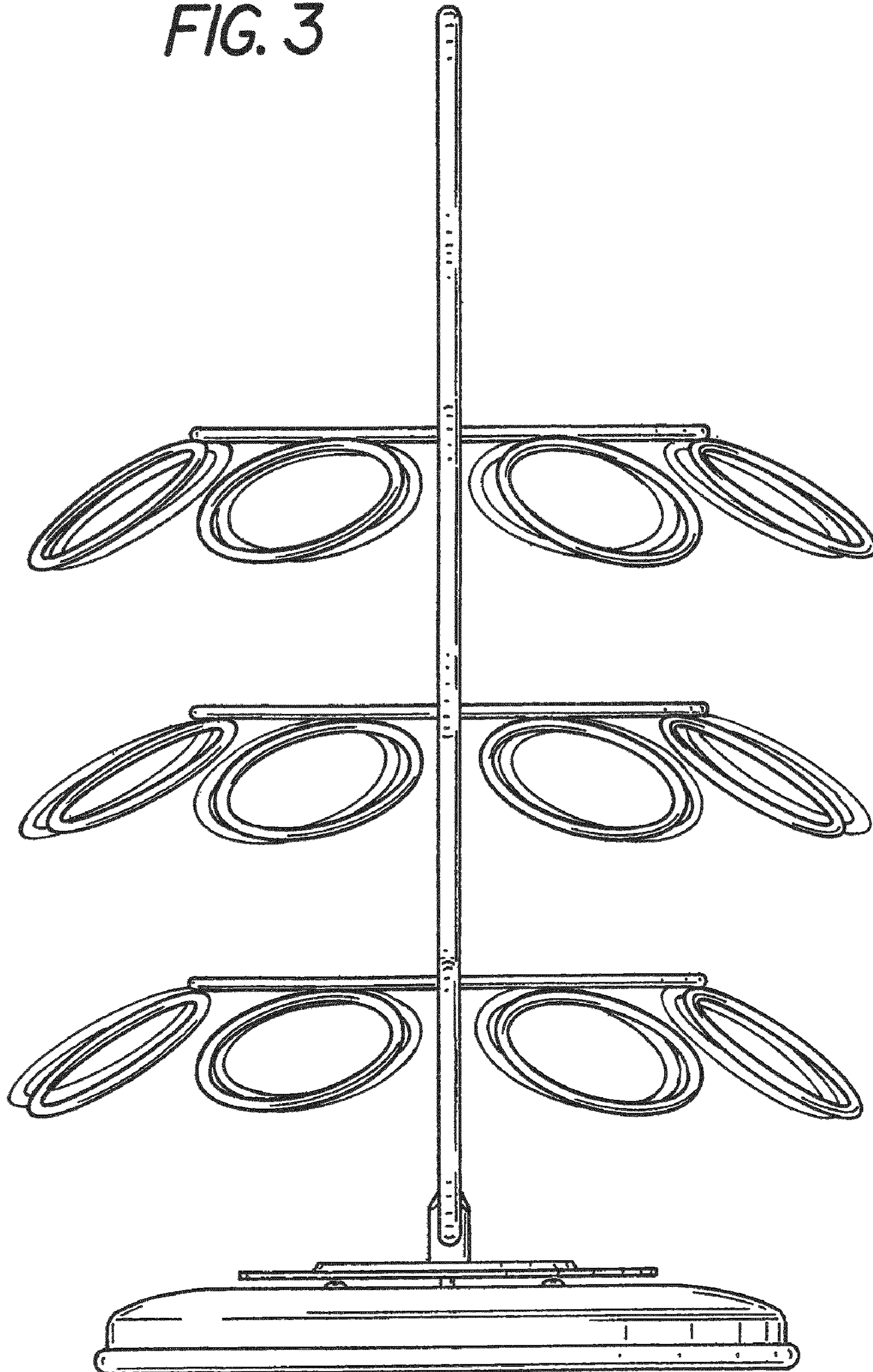

FIG. 4

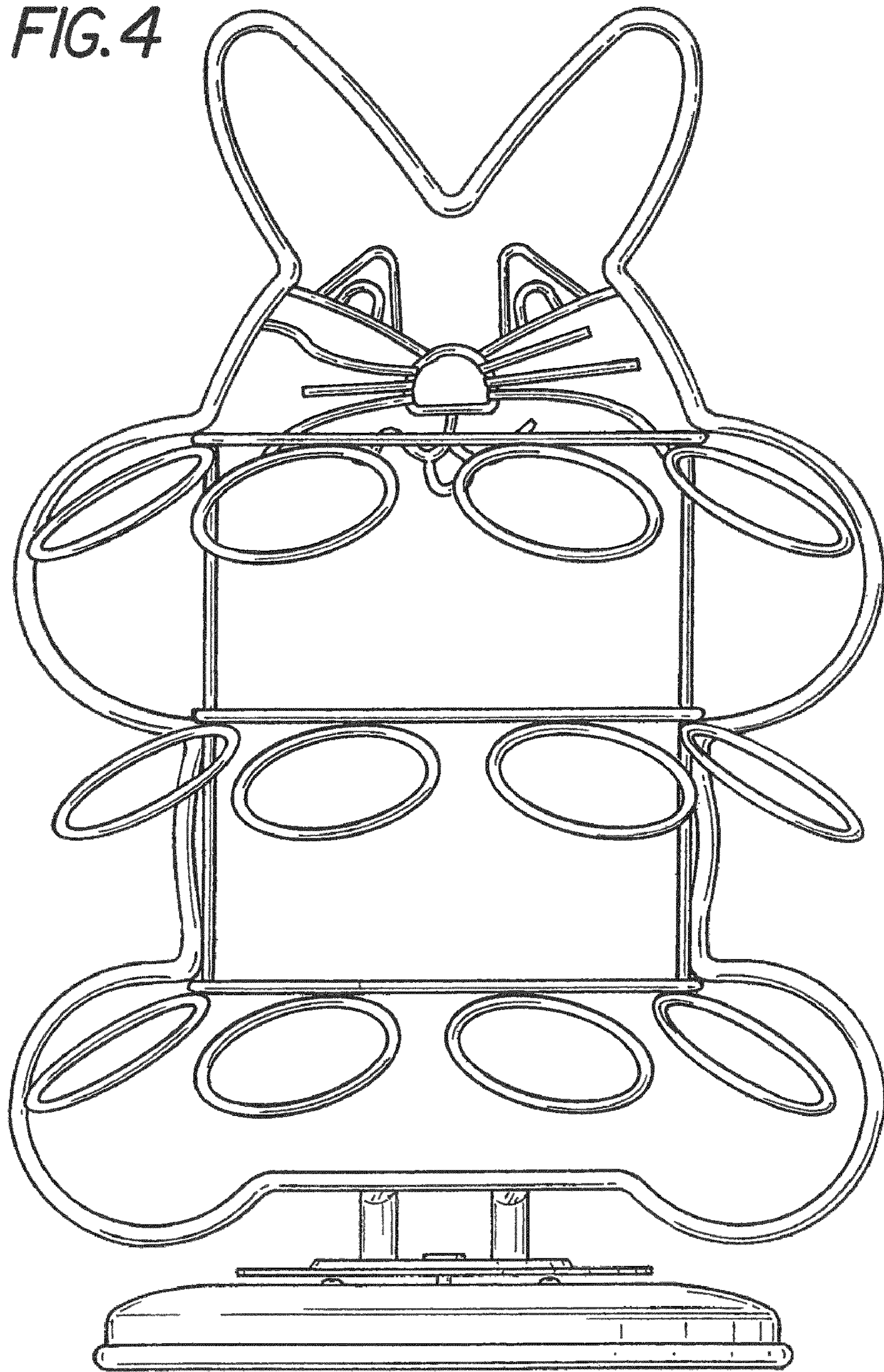

FIG. 5

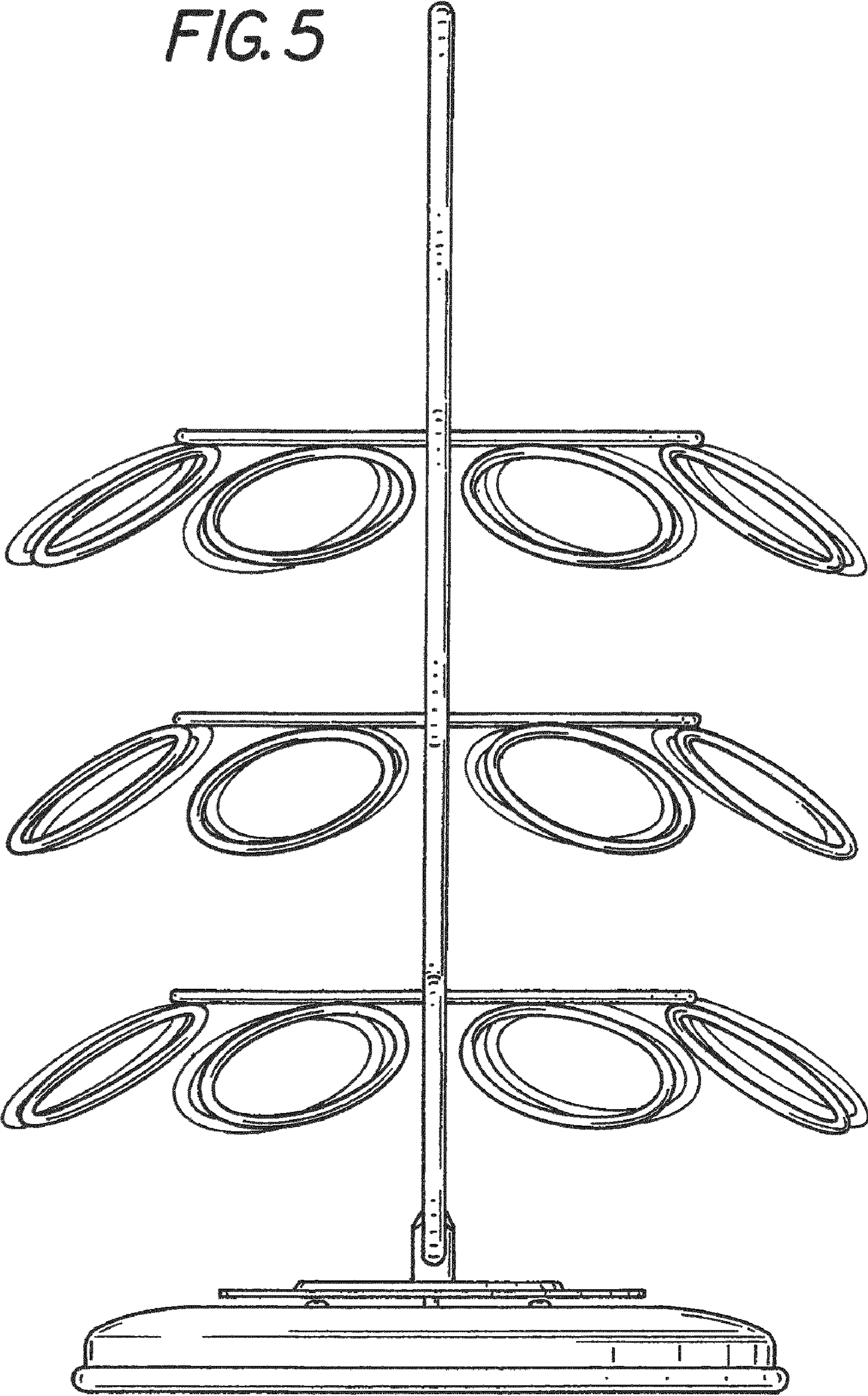

FIG. 6

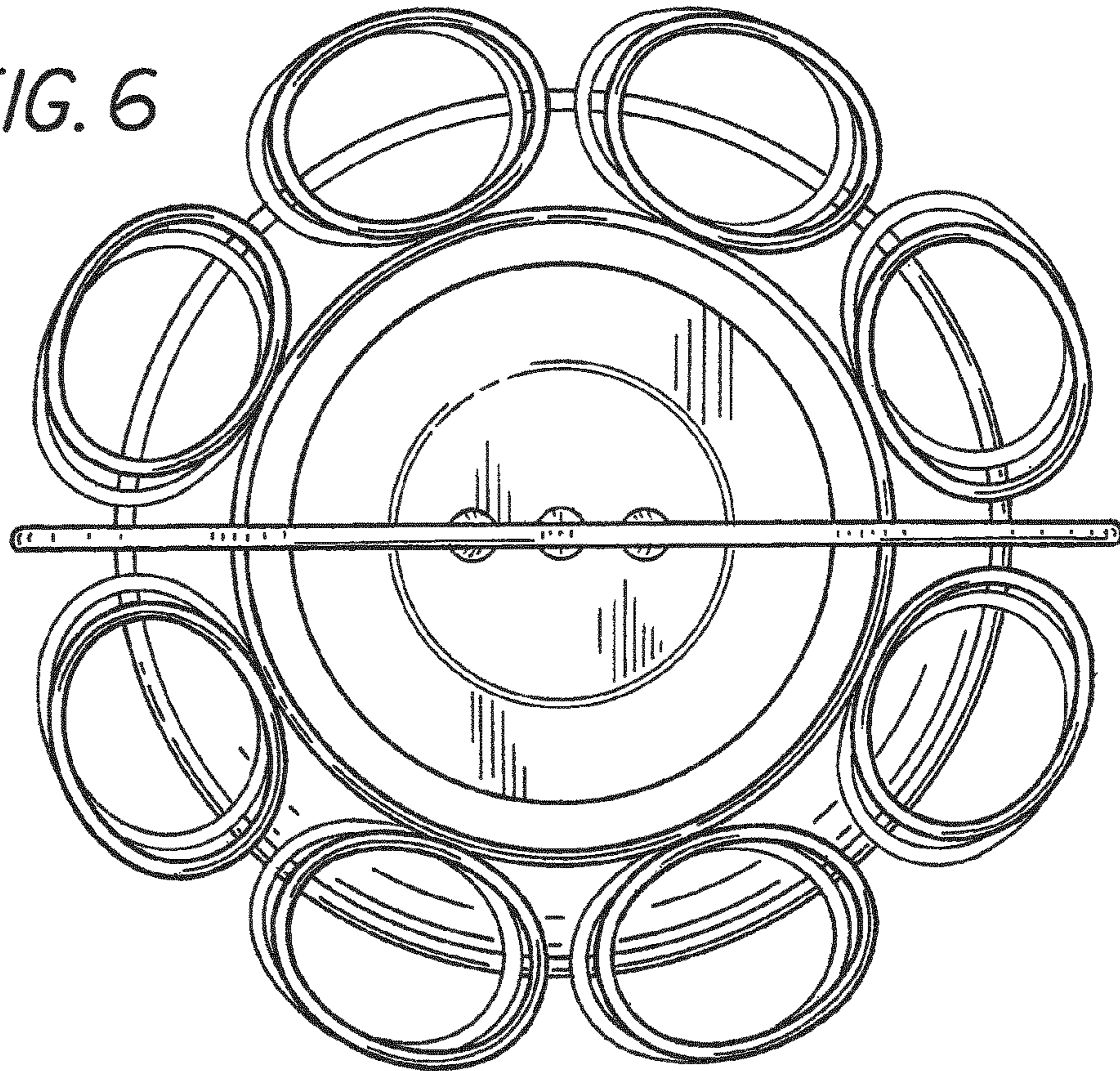

FIG. 7

