

US00D636615S

(12) **United States Design Patent**
Grela

(10) **Patent No.:** **US D636,615 S**
(45) **Date of Patent:** **** Apr. 26, 2011**

(54) **TOOLBOX**

(76) Inventor: **Larry Mitchell Grela**, Plainfield, IL
(US)

(**) Term: **14 Years**

(21) Appl. No.: **29/314,644**

(22) Filed: **Apr. 15, 2009**

(51) **LOC (9) Cl.** **06-07**

(52) **U.S. Cl.** **D6/400**

(58) **Field of Classification Search** D6/445,
D6/396, 422-428, 432, 436-439, 559-560,
D6/589, 400, 434, 510, 441; D34/17, 19,
D34/20, 21; D3/279, 297, 905, 318; 312/249.4,
312/249.8, 249.9, 249.11, 309, 282, 332.1;
206/349, 372, 376, 370; 280/47.34; 362/154;
451/361; 70/78; D24/185, 172

See application file for complete search history.

(56) **References Cited**

U.S. PATENT DOCUMENTS

2,981,549	A *	4/1961	Hotton	280/47.35
D205,523	S *	8/1966	Doman	D34/19
3,462,208	A	8/1969	Pittman et al.	
4,288,132	A	9/1981	Znamirovski	
D272,111	S *	1/1984	Anzalone	D6/400
D273,906	S *	5/1984	Norlin	D34/19
D283,263	S *	4/1986	Richey	D34/19
4,836,626	A	6/1989	Taylor et al.	
D337,404	S *	7/1993	Miles	D34/19
5,257,860	A	11/1993	Slivon	
5,403,139	A	4/1995	Slivon et al.	

(Continued)

OTHER PUBLICATIONS

PCT Search Report of Aug. 12, 2009 for PCT/US2008/003543.

(Continued)

Primary Examiner — Philip S Hyder

Assistant Examiner — Sydney R Buffalow

(74) *Attorney, Agent, or Firm* — John G. Chupa

(57) **CLAIM**

The ornamental design for a design for a toolbox, as shown and described.

DESCRIPTION

FIG. 1 is a front view thereof;
 FIG. 2 is a back view thereof;
 FIG. 3 is a top view thereof;
 FIG. 4 is a bottom view thereof;
 FIG. 5 is a right side view thereof;
 FIG. 6 is a left side view thereof;
 FIG. 7 is a perspective view thereof;
 FIG. 8 is an enlarged view of the handle portion taken from FIG. 7;
 FIG. 9 is a front view of a second embodiment of a toolbox;
 FIG. 10 is a back view of the second embodiment thereof;
 FIG. 11 is a top view of the second embodiment thereof;
 FIG. 12 is a bottom view of the second embodiment thereof;
 FIG. 13 is a right side view of the second embodiment thereof;
 FIG. 14 is a left side view of the second embodiment thereof;
 FIG. 15 is a perspective view of the second embodiment thereof;
 FIG. 16 is a front view of a third embodiment of a toolbox;
 FIG. 17 is a back view of the third embodiment thereof;
 FIG. 18 is a top view of the third embodiment thereof;
 FIG. 19 is a bottom view of the third embodiment thereof;
 FIG. 20 is a right side view of the third embodiment thereof;
 FIG. 21 is a left side view of the third embodiment thereof;
 FIG. 22 is a perspective view of the third embodiment thereof;
 FIG. 23 is an enlarged view of the third embodiment thereof;
 FIG. 24 is a front view of a fourth embodiment of a toolbox;
 FIG. 25 is a back view of the fourth embodiment thereof;
 FIG. 26 is a top view of the fourth embodiment thereof;
 FIG. 27 is a bottom view of the fourth embodiment thereof;
 FIG. 28 is a right side view of the fourth embodiment thereof;
 FIG. 29 is a left side view of the fourth embodiment thereof;
 and,
 FIG. 30 is a perspective view of the fourth embodiment thereof.

The broken line shown in the drawings are directed to environment, and are for informational purposes only and form no part of the claimed design.

1 Claim, 20 Drawing Sheets

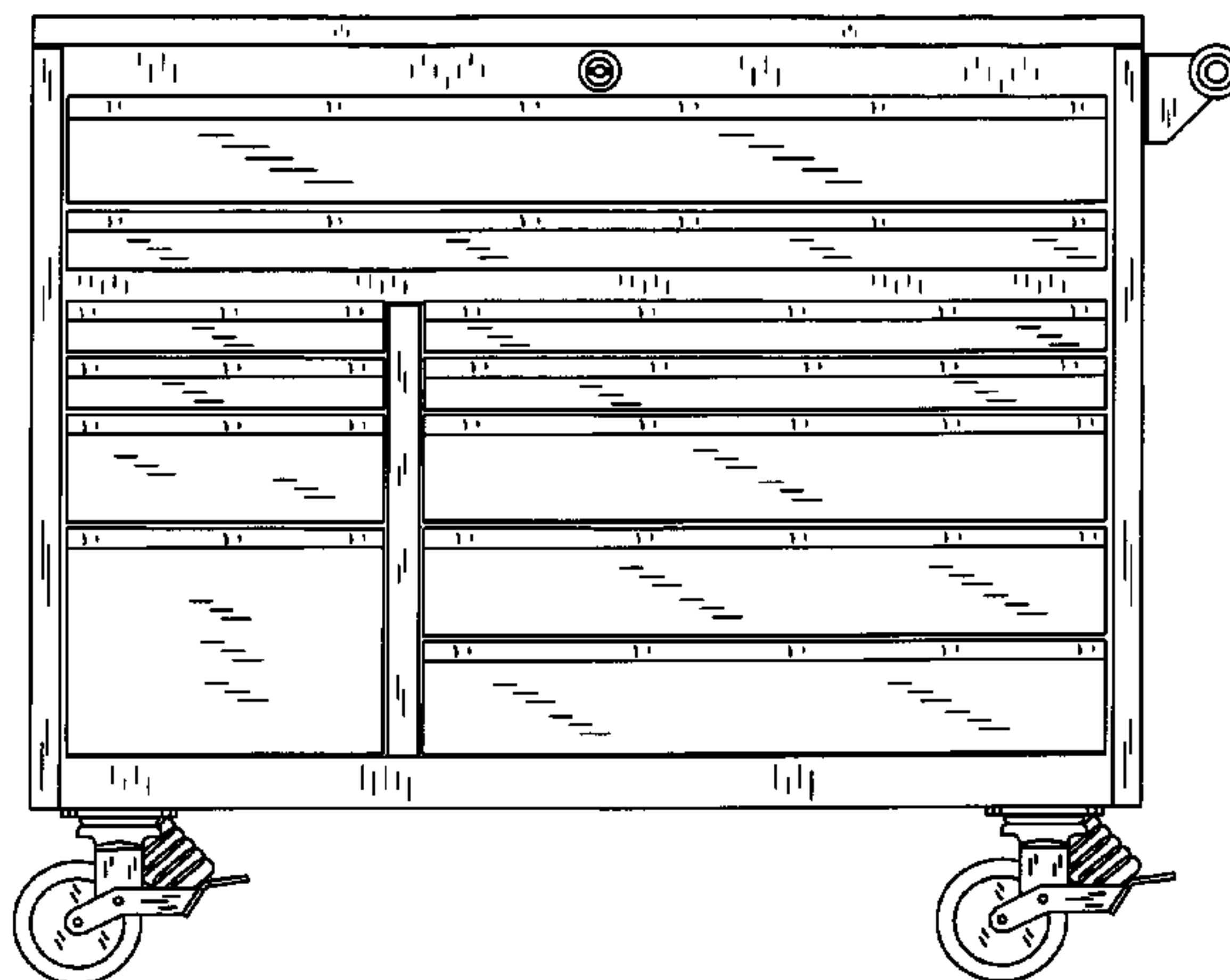

US D636,615 S

Page 2

U.S. PATENT DOCUMENTS

5,645,332 A 7/1997 Snoke et al.
5,720,535 A 2/1998 Mehman
5,816,550 A 10/1998 Watanabe et al.
5,857,757 A 1/1999 Bieker et al.
5,862,689 A 1/1999 Wen
6,039,417 A 3/2000 Snoke et al.
D423,817 S * 5/2000 Holcomb et al. D6/445
D423,818 S * 5/2000 Holcomb et al. D6/445
6,076,906 A 6/2000 Royal
D427,807 S * 7/2000 Holcomb et al. D6/445
6,095,532 A 8/2000 Martin
6,109,709 A 8/2000 Holcomb et al.
6,152,552 A 11/2000 Snoke et al.
D444,930 S * 7/2001 Brown D34/19
6,283,292 B1 9/2001 Chen
D448,586 S * 10/2001 O'Hare et al. D6/446
6,341,511 B1 1/2002 Snoke et al.
6,374,649 B1 * 4/2002 Holcomb et al. 70/78
6,375,235 B1 4/2002 Mehmen
6,409,187 B1 6/2002 Crow, Jr.
D470,687 S * 2/2003 Binse et al. D6/436
D477,724 S * 7/2003 Bishop D6/434
6,736,265 B2 5/2004 Kipper et al.
6,851,286 B2 2/2005 Dube et al.
6,935,641 B2 8/2005 Hahn
7,048,347 B1 * 5/2006 Liu 312/332.1
D523,607 S * 6/2006 Huguet D34/21
7,121,638 B1 10/2006 Eggert et al.
D546,017 S * 7/2007 Wise D34/19
7,296,808 B2 * 11/2007 Huguet 280/47.34

D560,079 S * 1/2008 Mehmen D6/441
7,338,354 B2 * 3/2008 Liu 451/361
D574,628 S * 8/2008 Grela D6/445
D587,047 S * 2/2009 Kalkwarf D6/510
D588,849 S * 3/2009 Kalkwarf D6/510
7,510,078 B2 3/2009 Schmidt et al.
D596,399 S 7/2009 Decarlo et al.
D610,830 S * 3/2010 Hand D6/400
D610,831 S * 3/2010 Hand D6/400
D615,208 S * 5/2010 Keffeler et al. D24/185
2003/0210517 A1 11/2003 Syring et al.
2004/0188296 A1 * 9/2004 Chen 206/370
2004/0195790 A1 10/2004 Wong Hahn
2006/0103278 A1 * 5/2006 Bousquet 312/332.1
2006/0145574 A1 * 7/2006 Hung 312/249.11
2006/0220503 A1 10/2006 Bousquet
2007/0013280 A1 1/2007 Retchloff
2007/0054608 A1 * 3/2007 Liu 451/361
2007/0063624 A1 * 3/2007 Liao 312/282
2007/0080511 A1 4/2007 Campbell
2007/0222166 A1 * 9/2007 Ruiz 280/47.35
2007/0228903 A1 * 10/2007 Liu 312/280
2007/0274042 A1 * 11/2007 Jackson et al. 361/695
2008/0180944 A1 * 7/2008 Galvez et al. 362/154
2009/0085448 A1 * 4/2009 Zhang 312/309
2009/0212676 A1 * 8/2009 Liu 312/249.11

OTHER PUBLICATIONS

Matco catalog and material.

* cited by examiner

FIG. 1

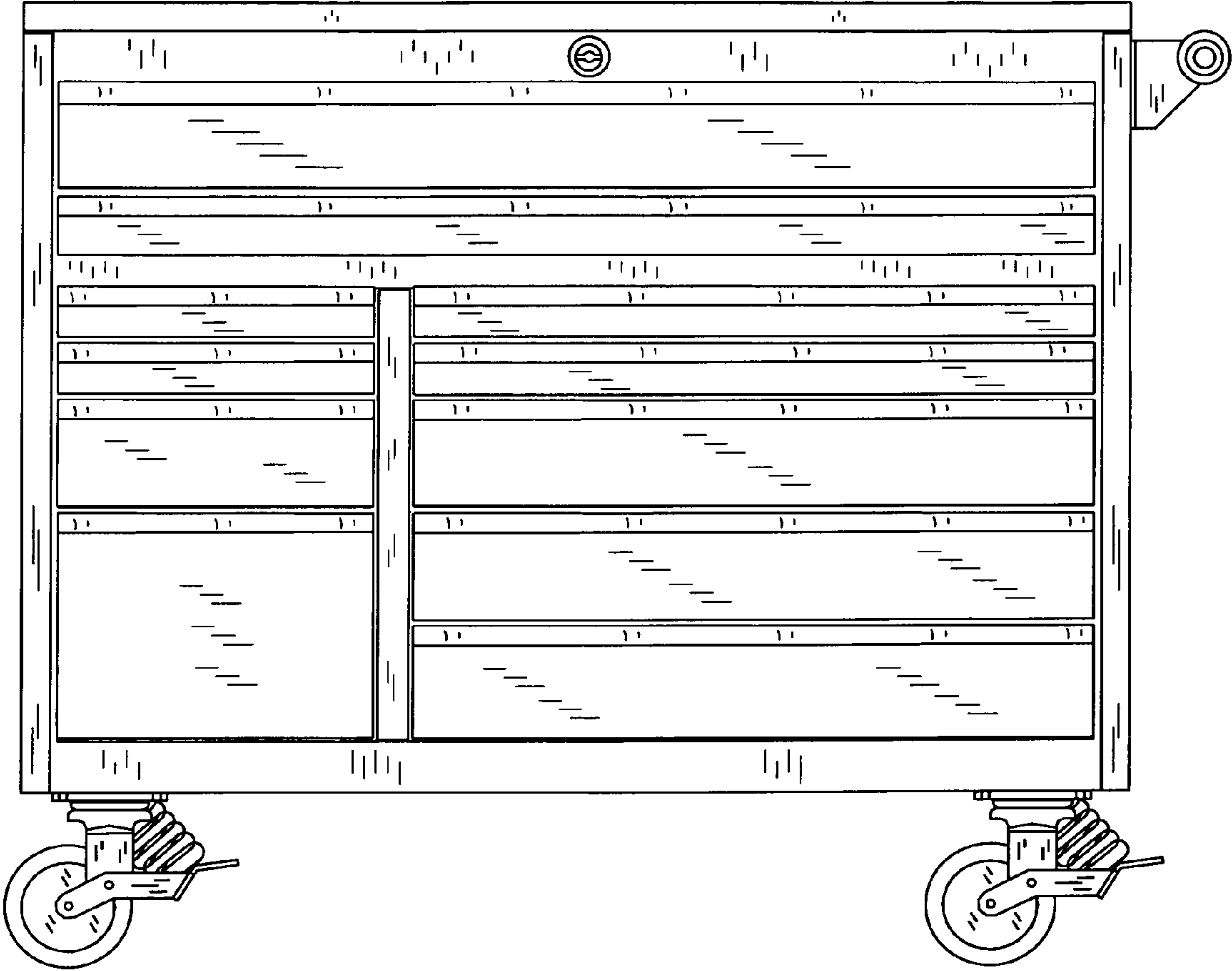

FIG. 2

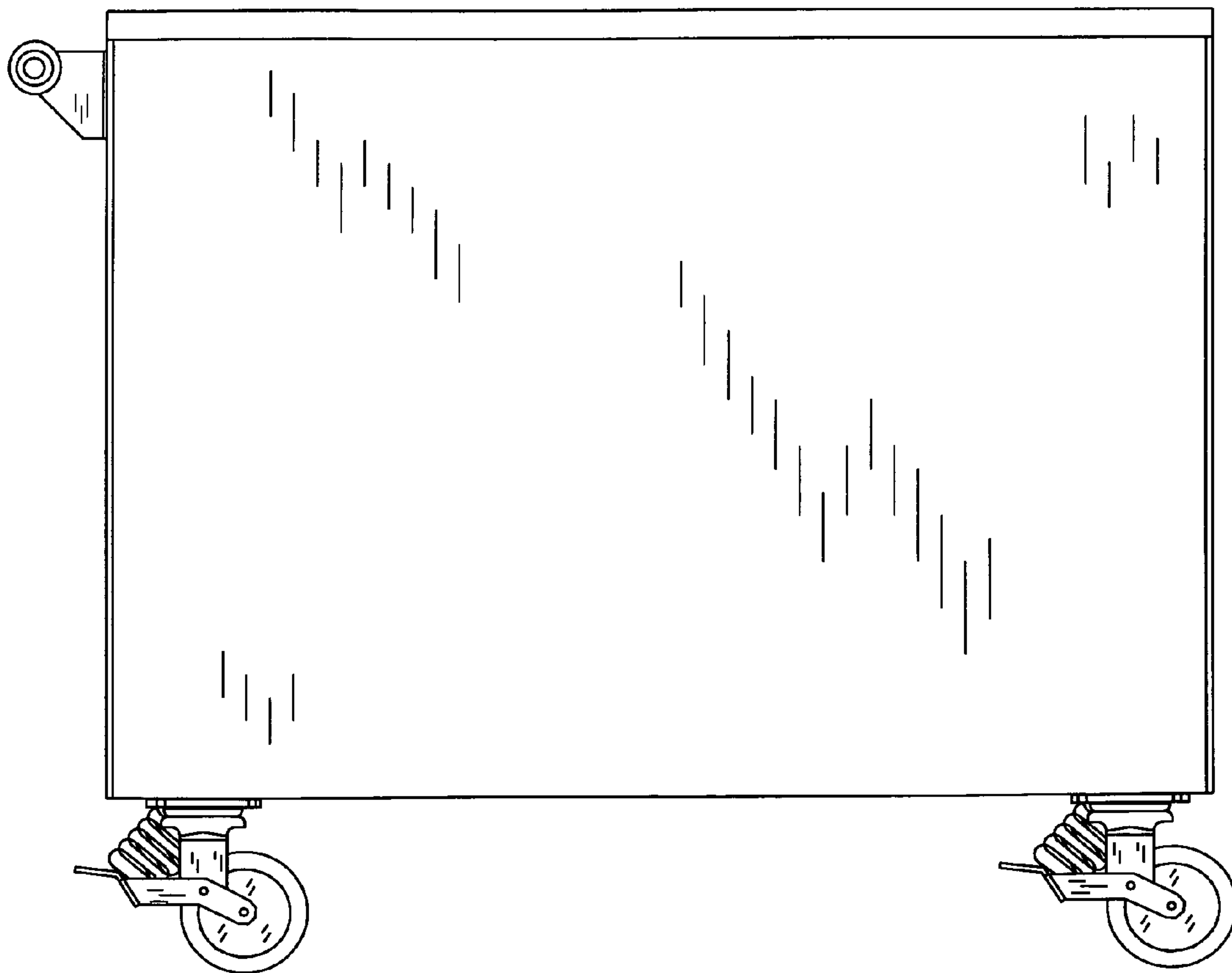

FIG. 3

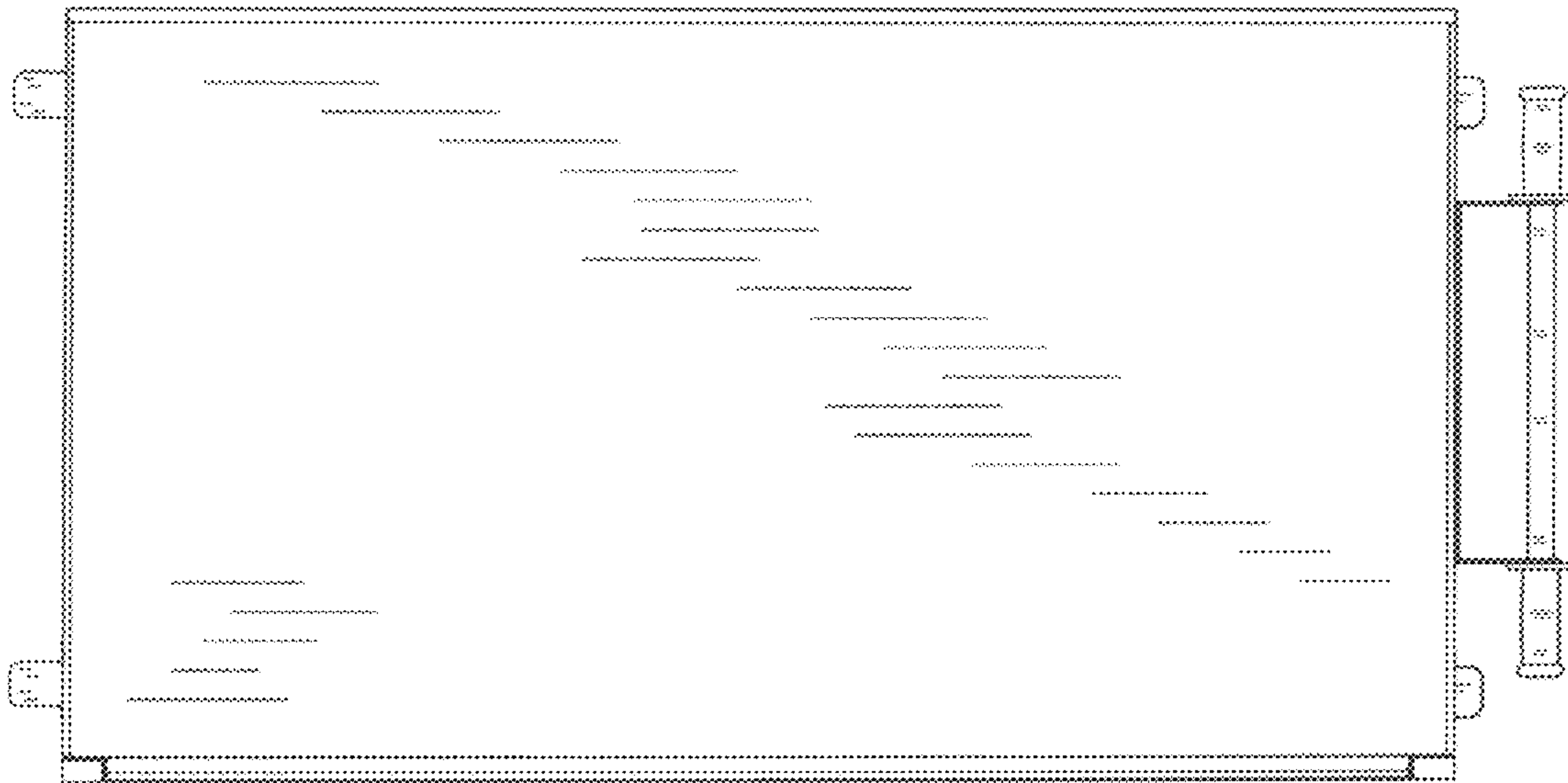

FIG. 4

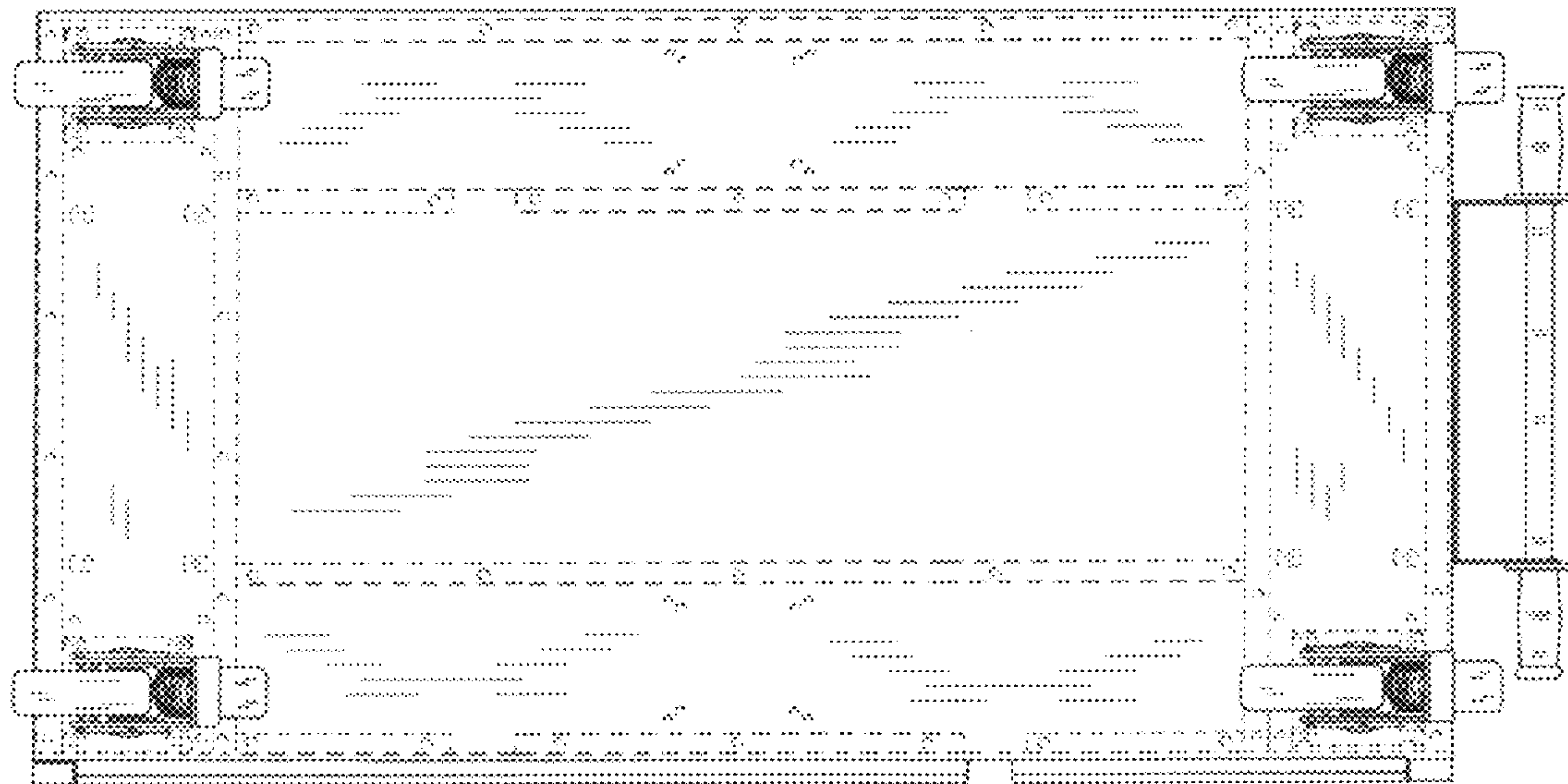

FIG. 5

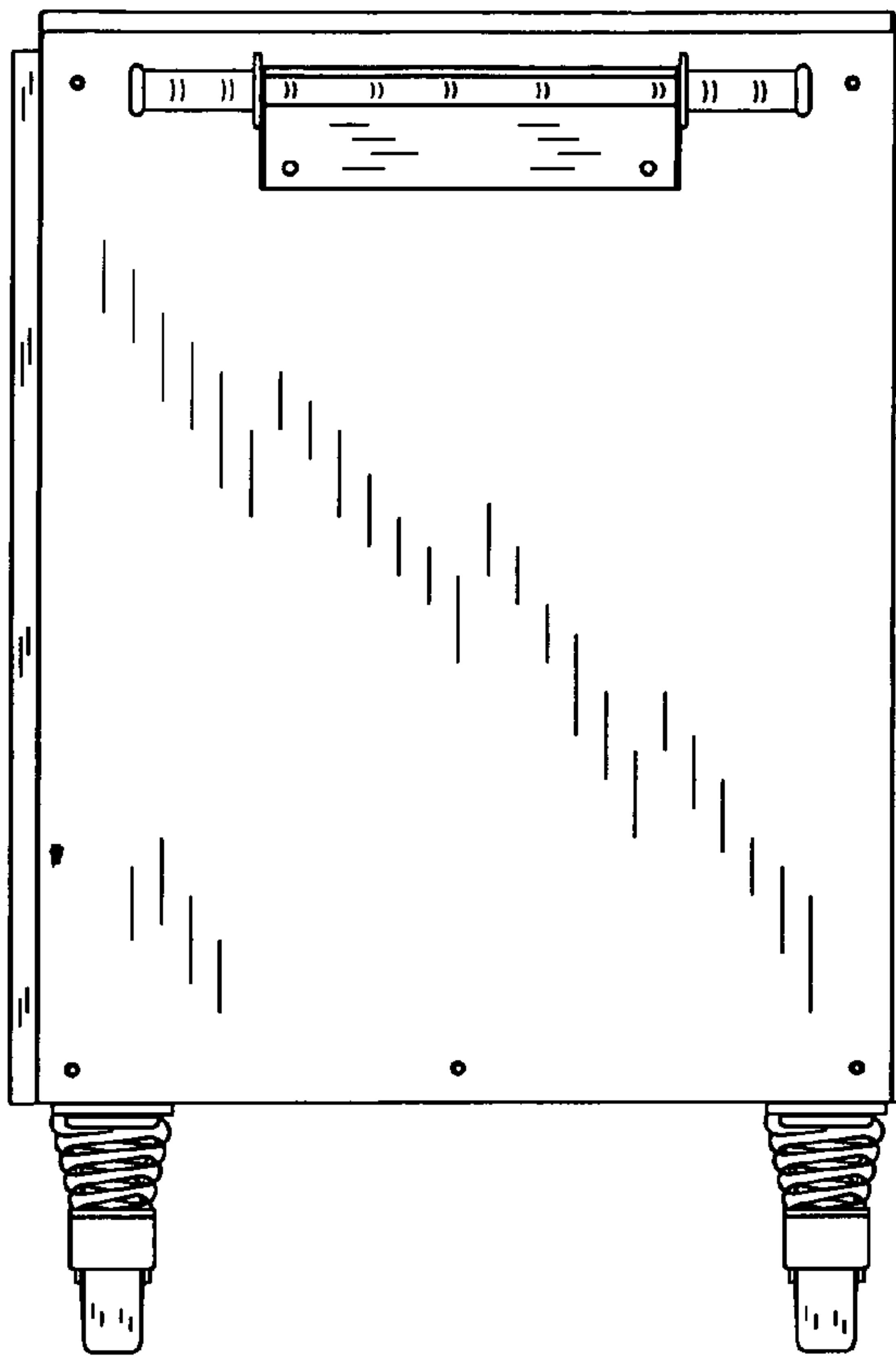

FIG. 6

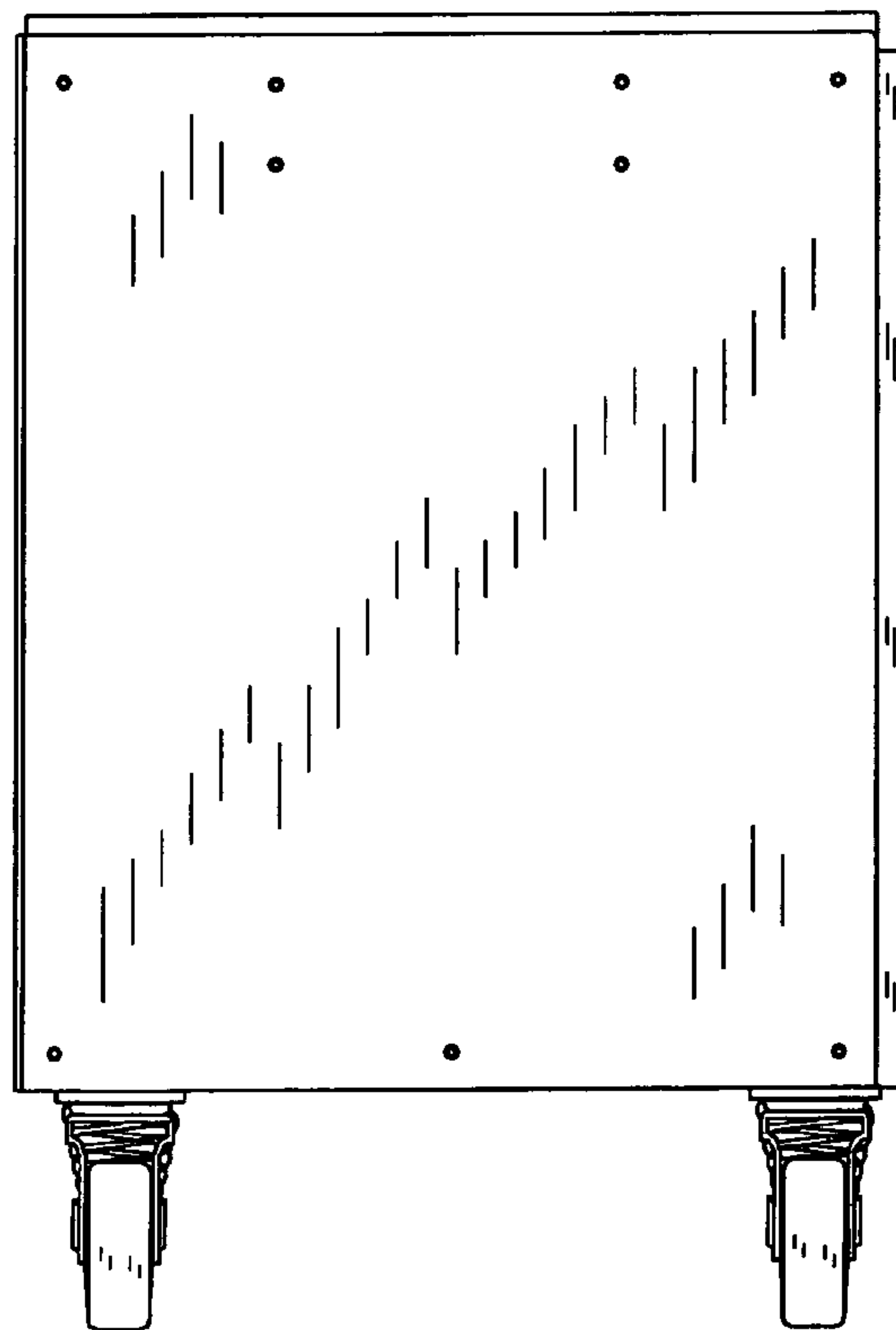

FIG. 7

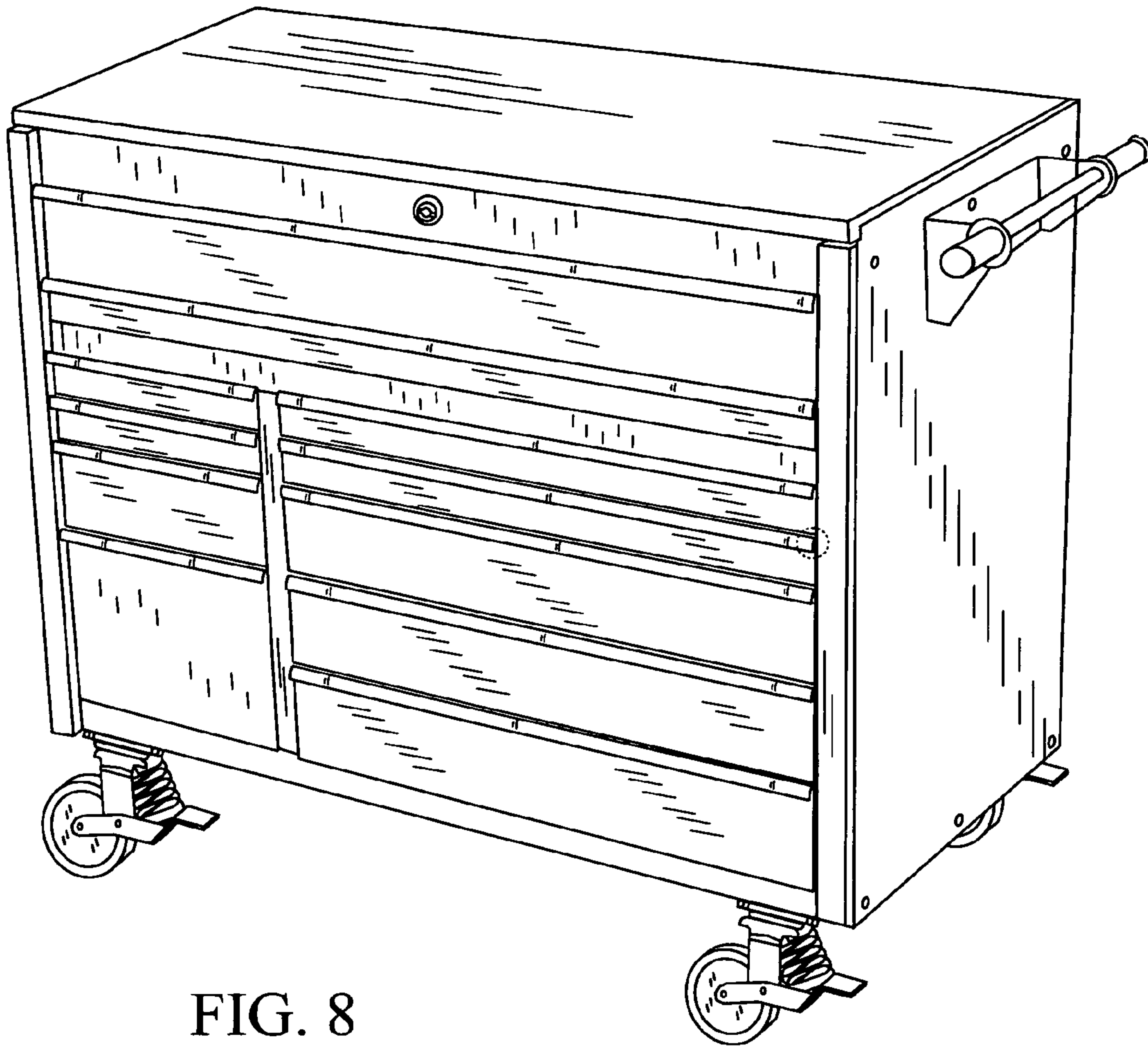

FIG. 8

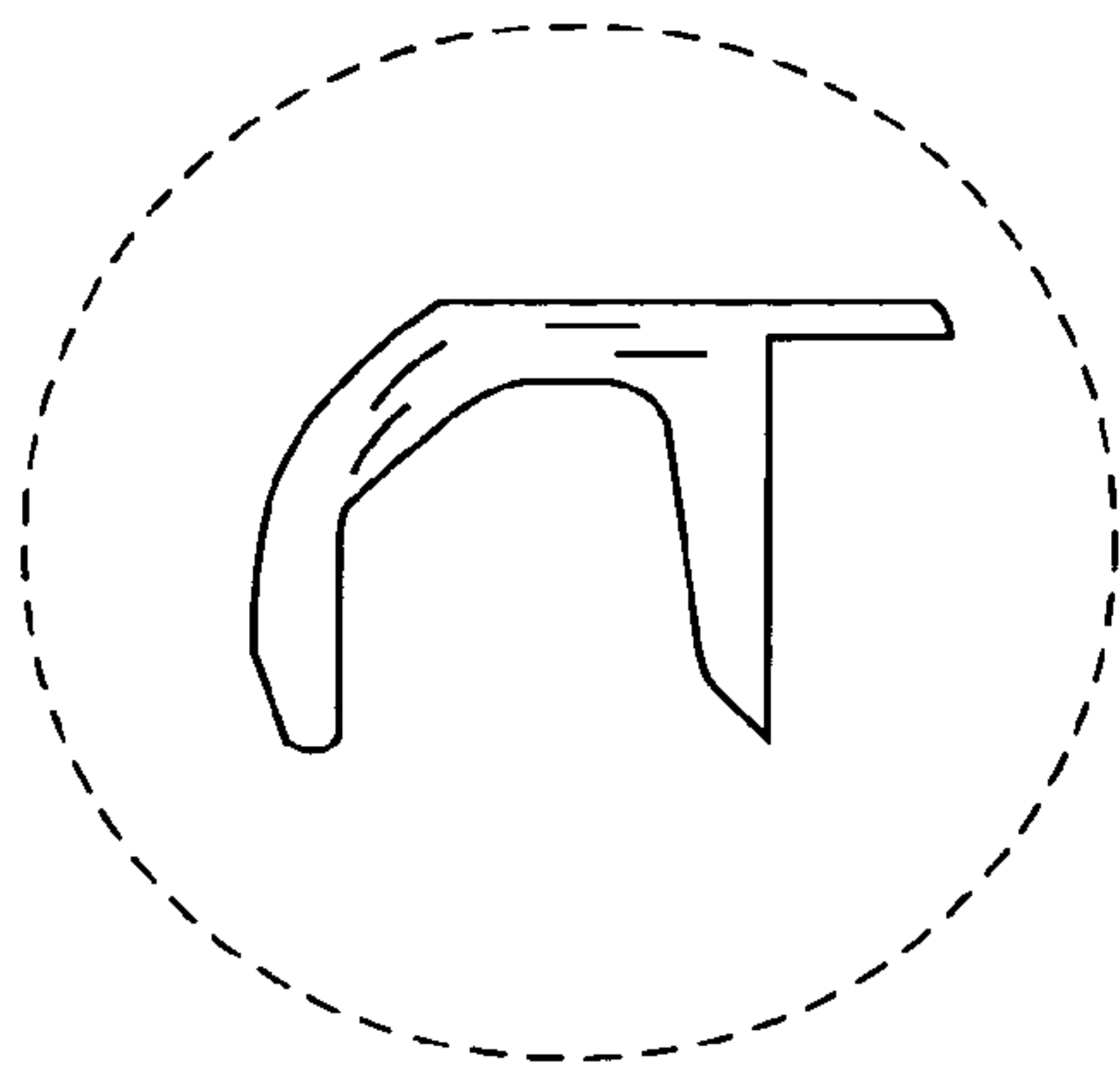

FIG. 9

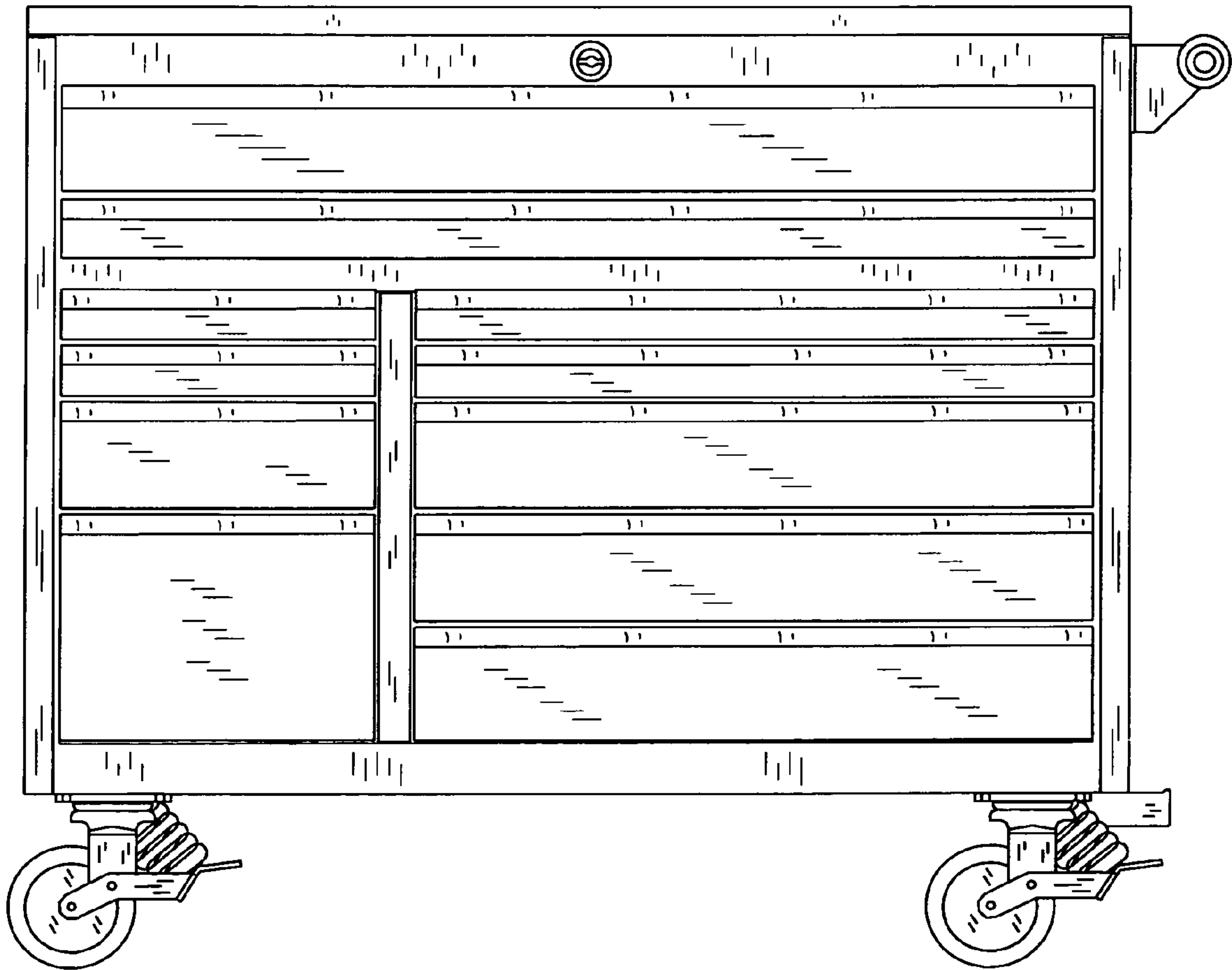

FIG. 10

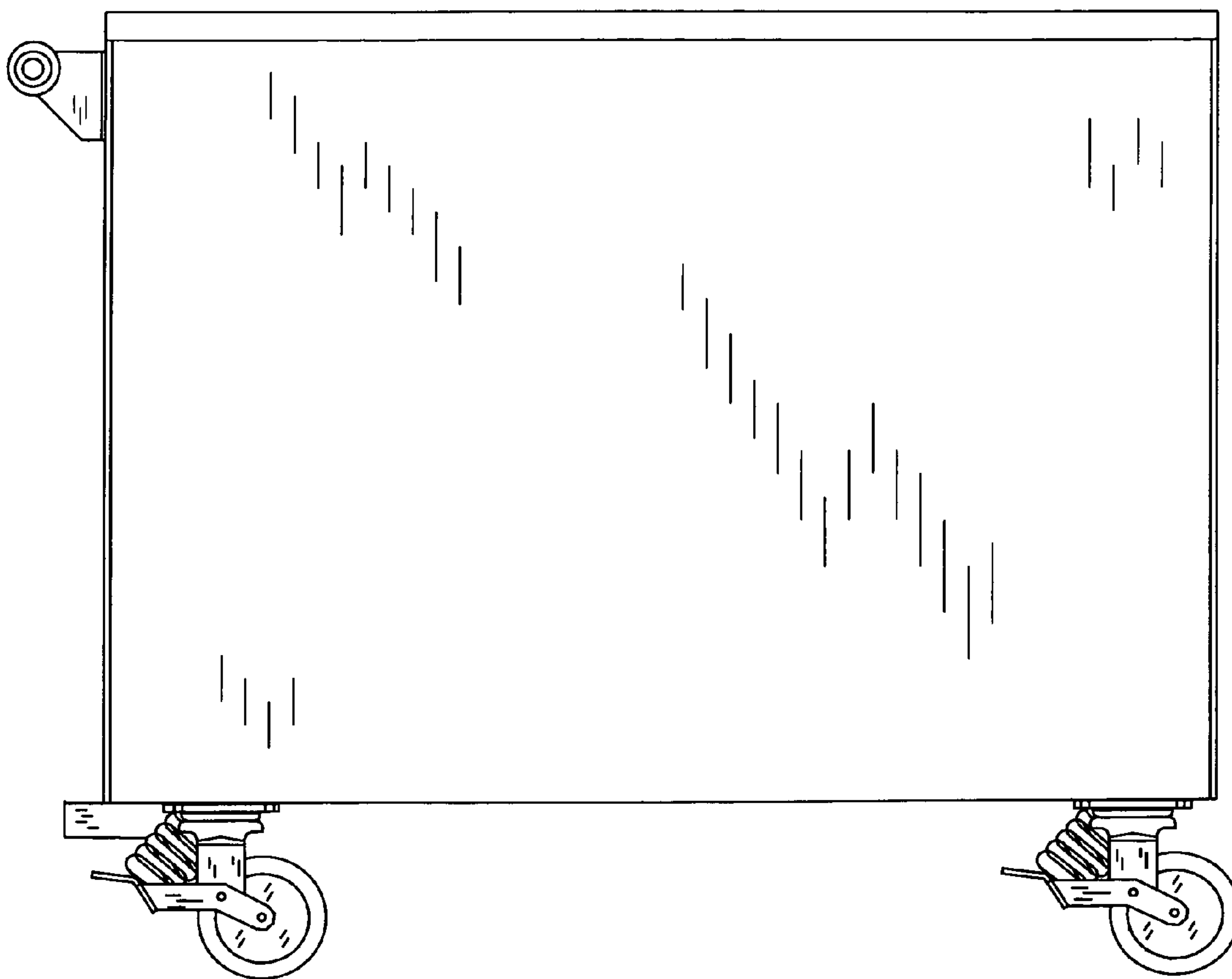

FIG. 11

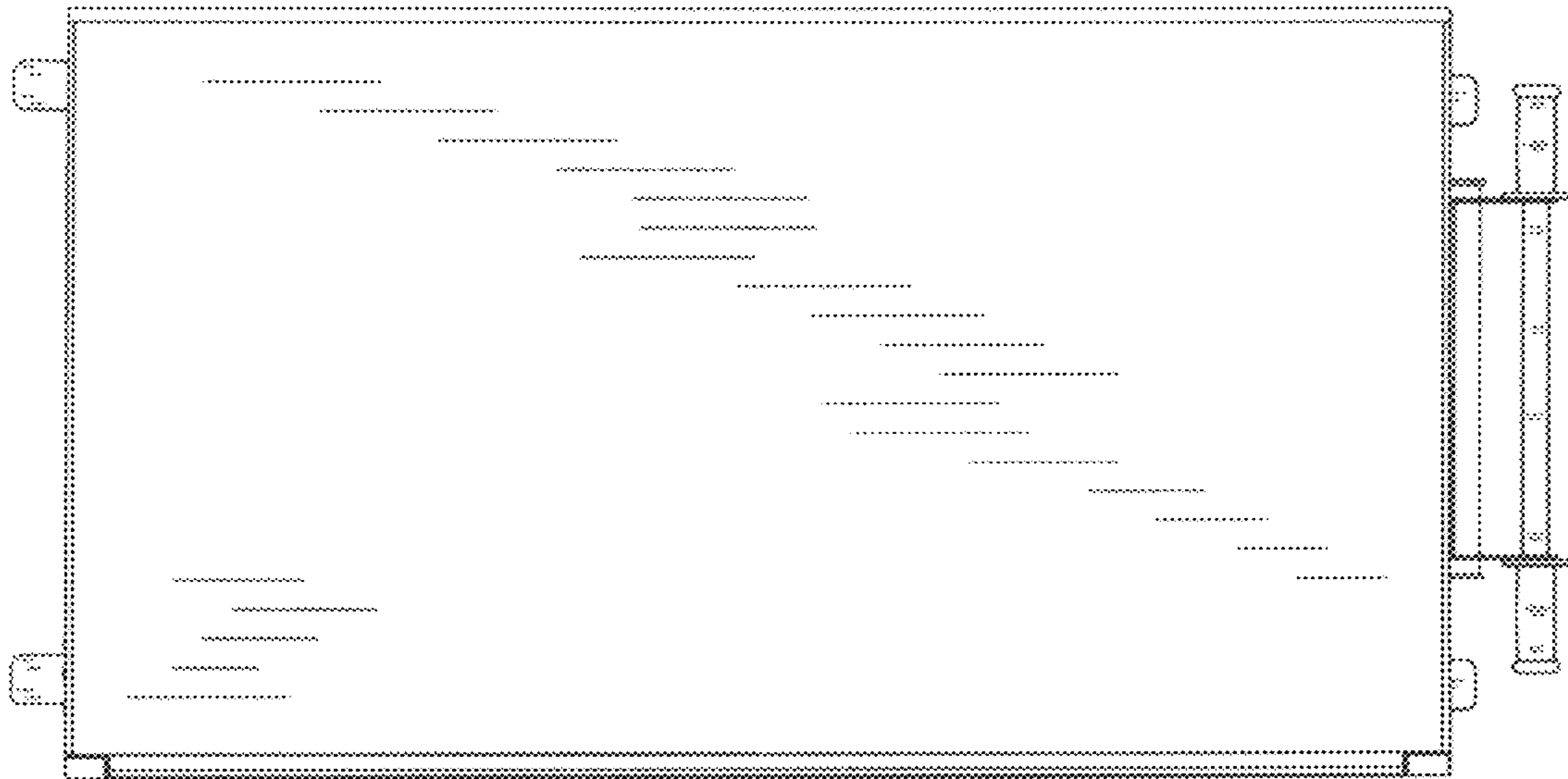

FIG. 12

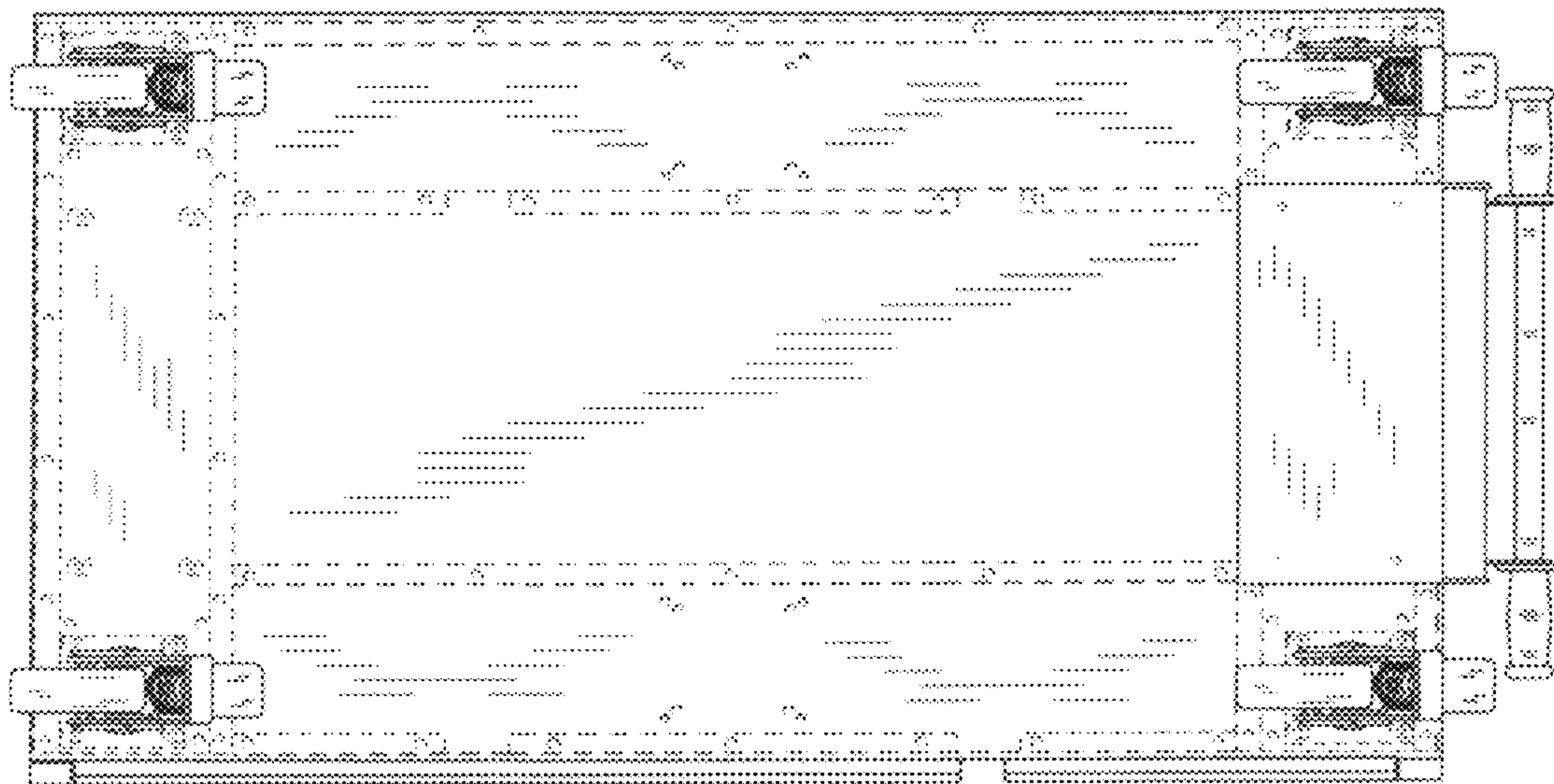

FIG. 13

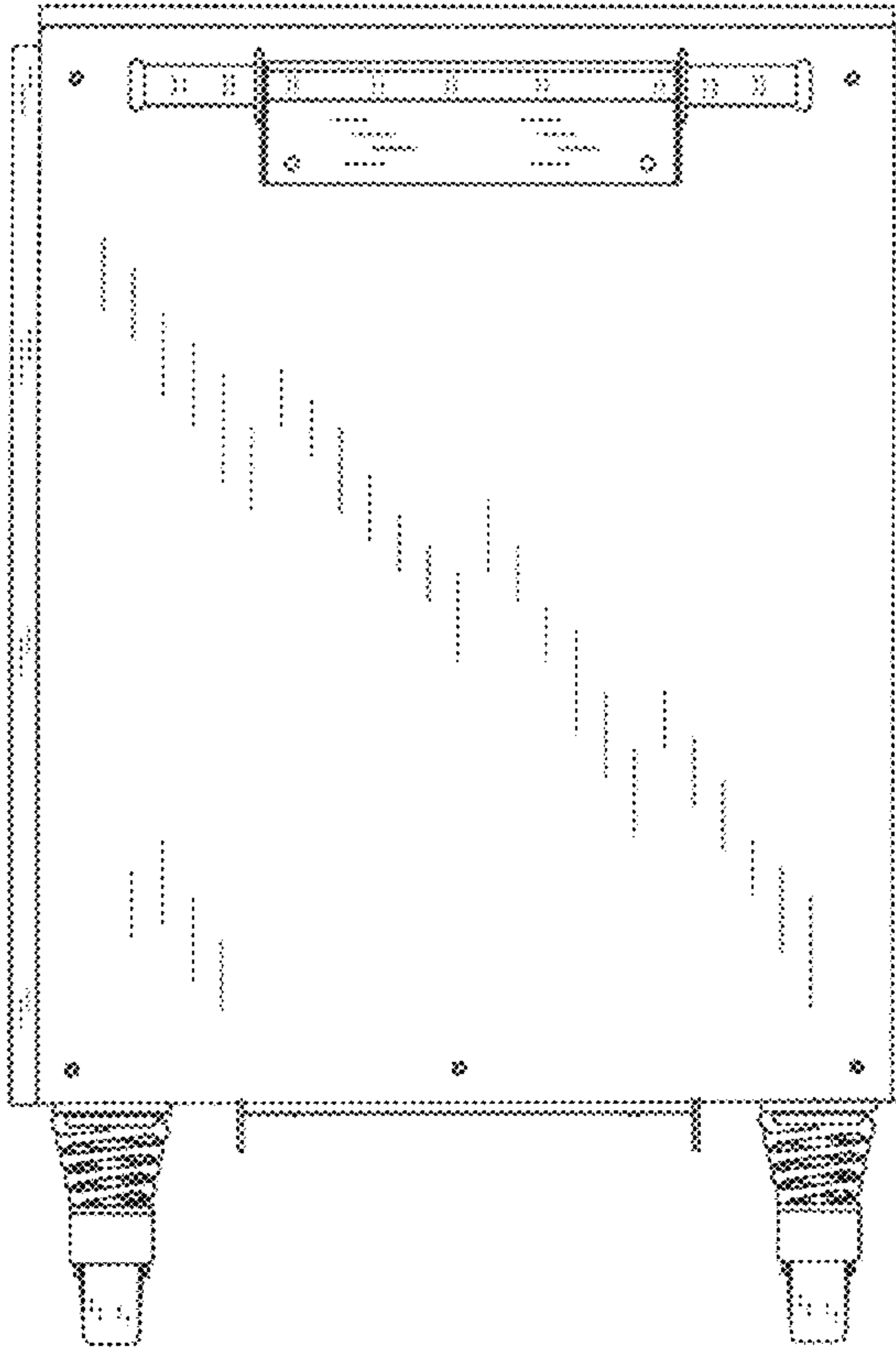

FIG. 14

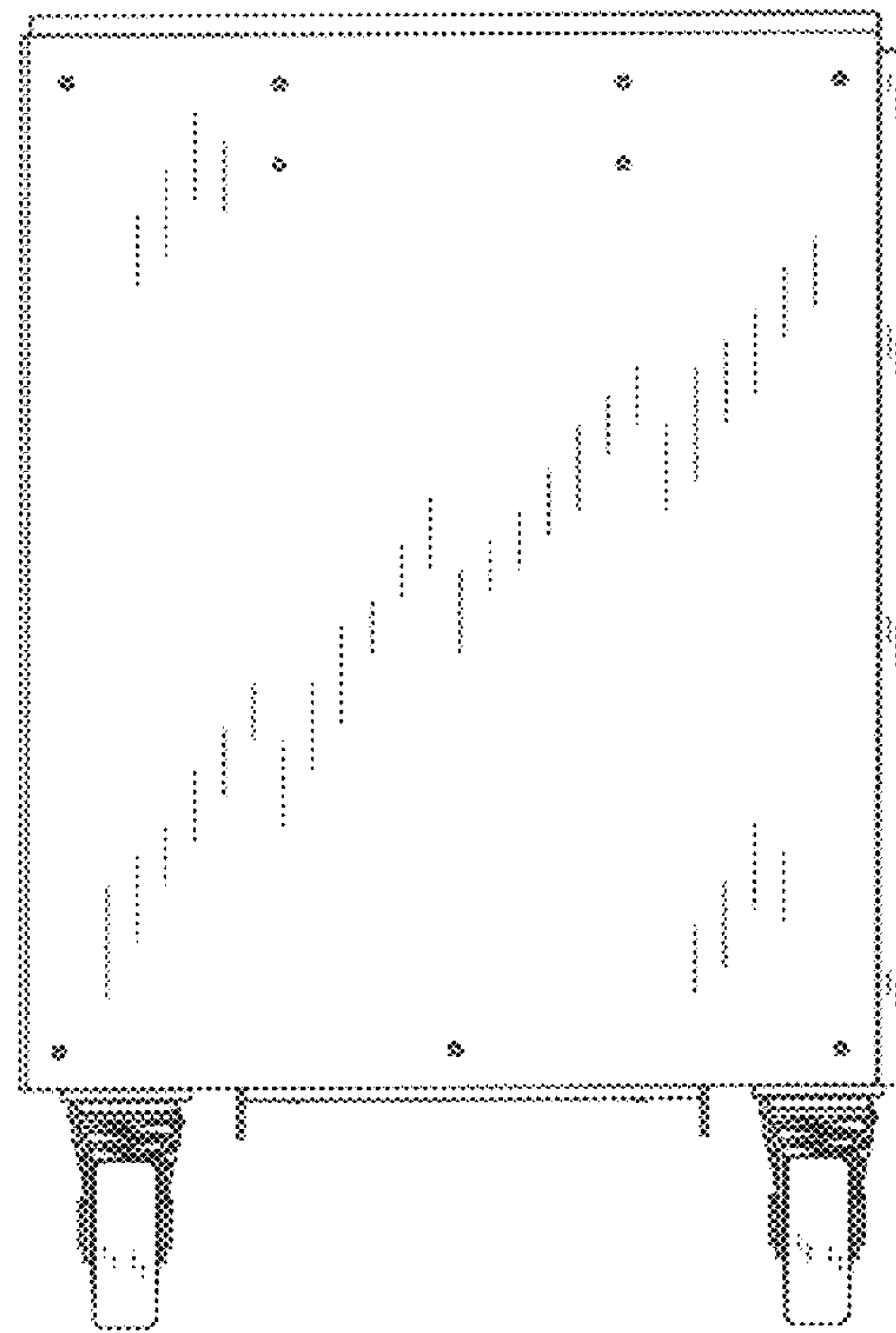

FIG. 15

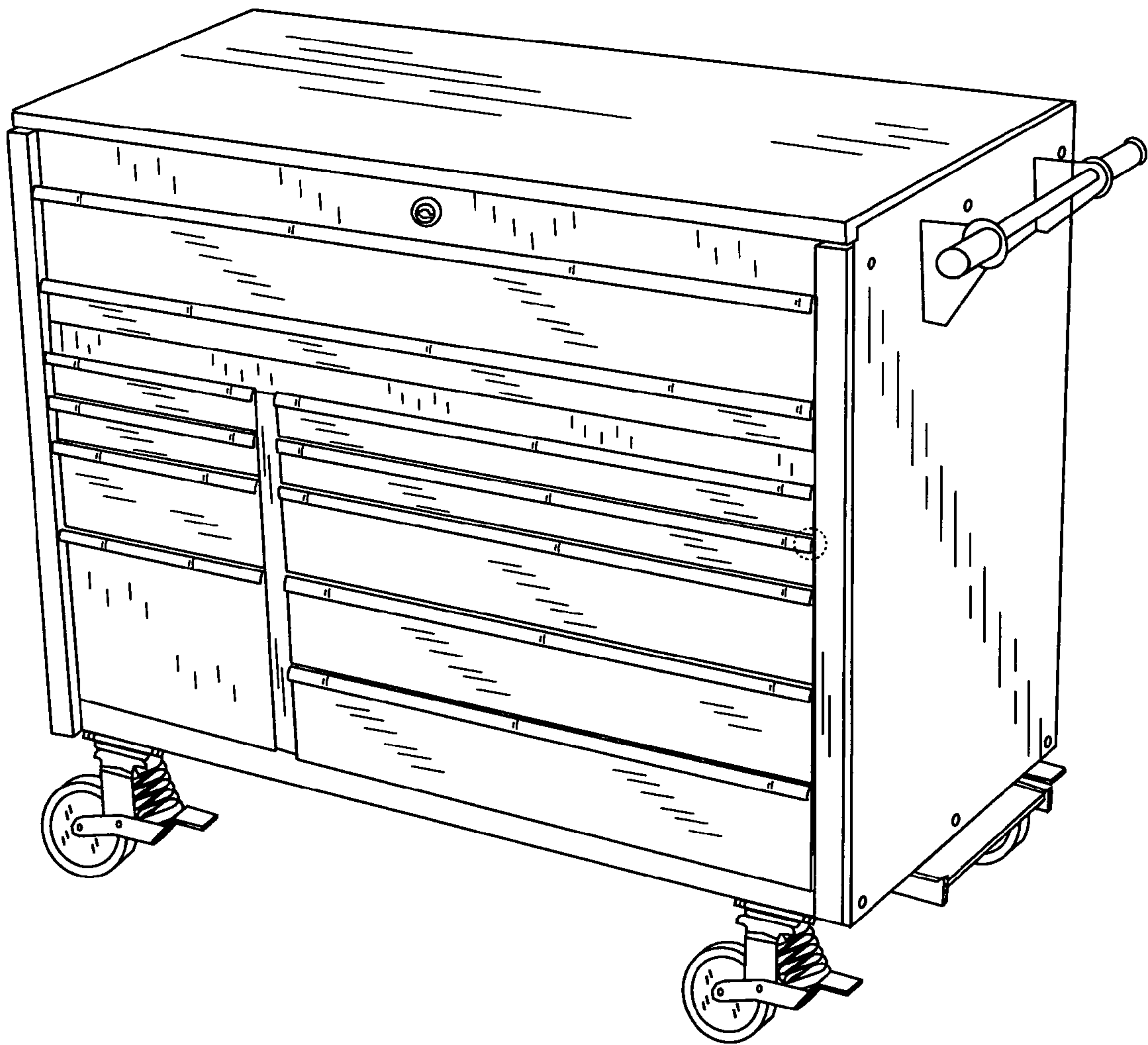

FIG. 16

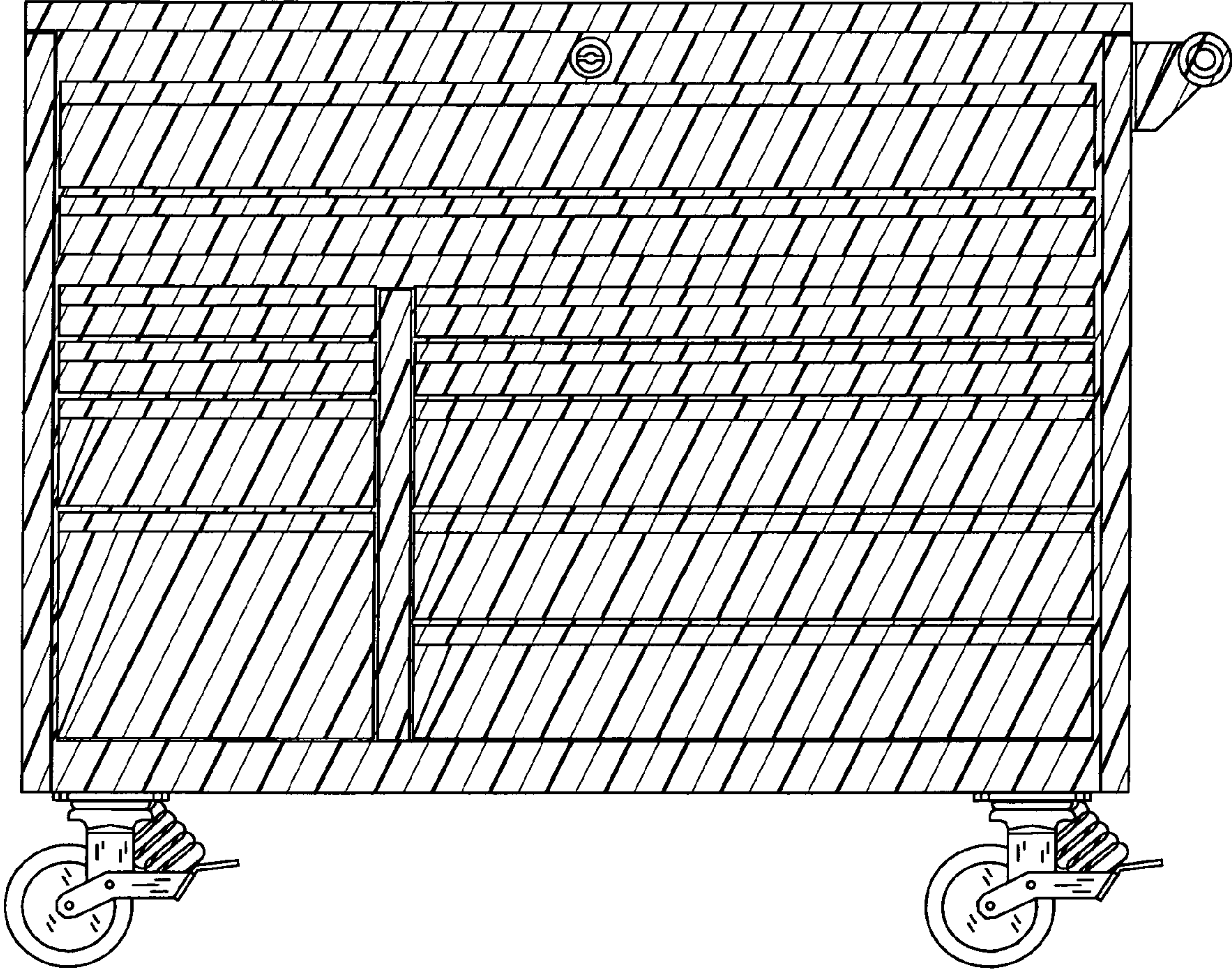

FIG. 17

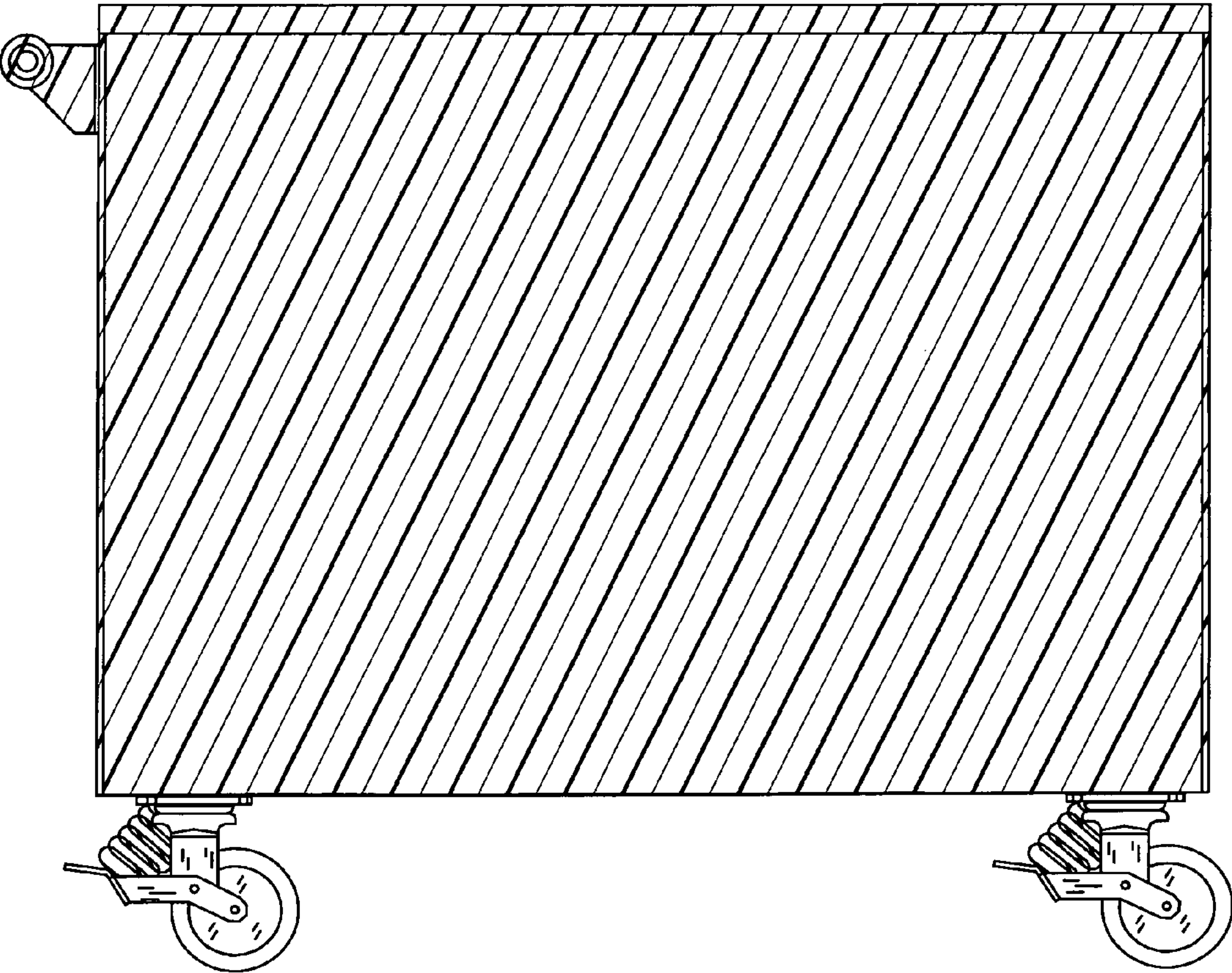

FIG. 18

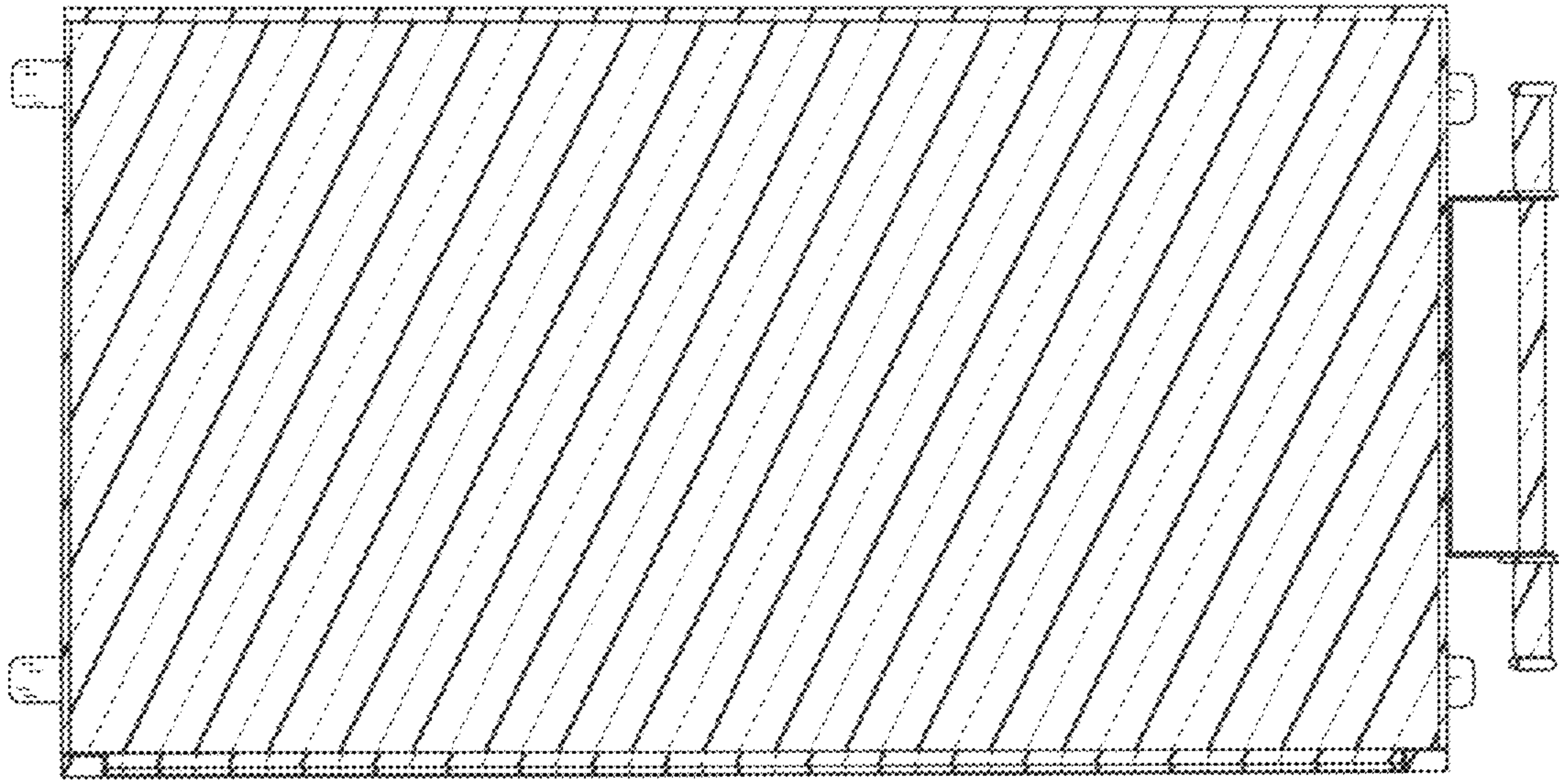

FIG. 19

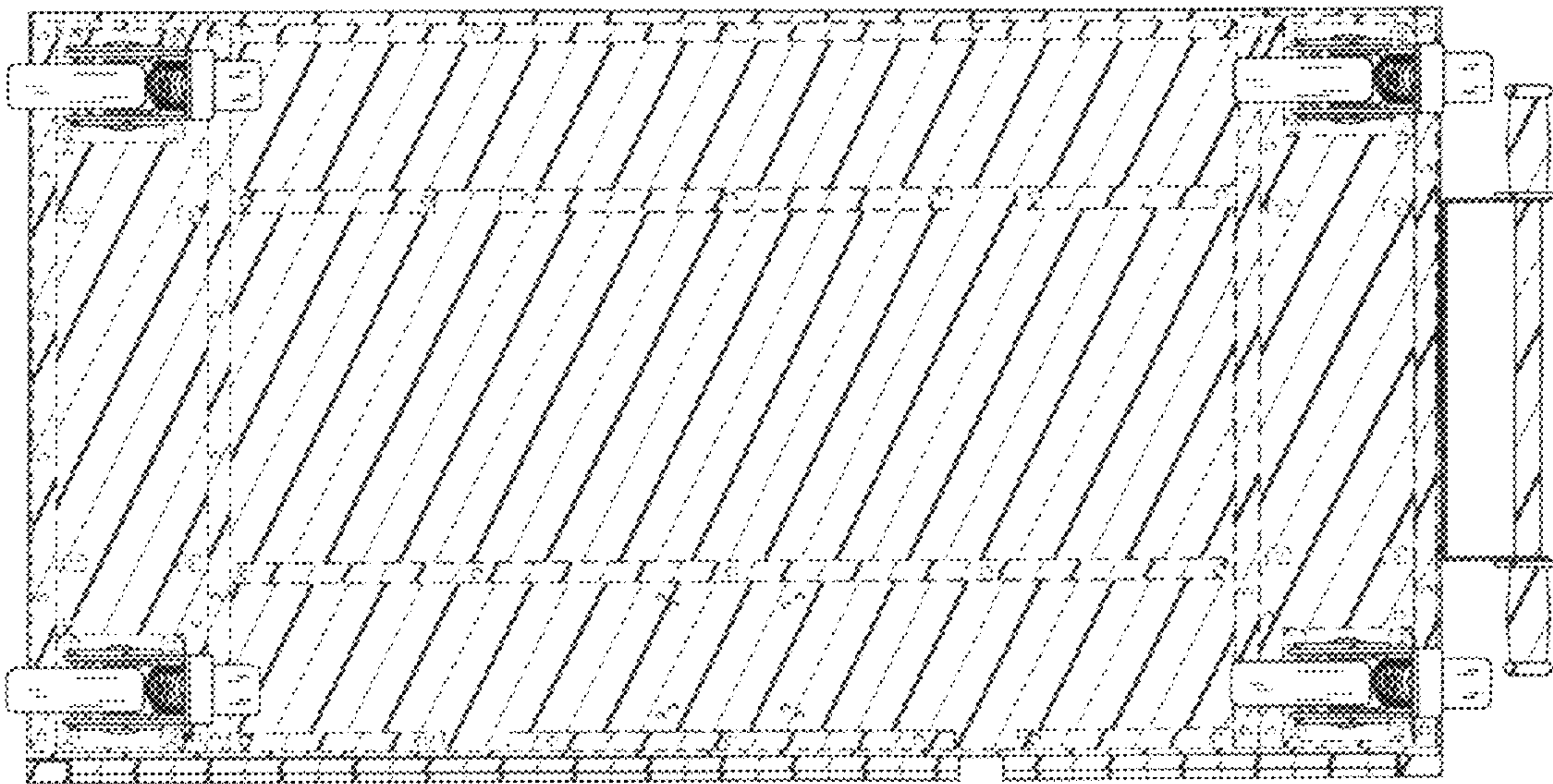

FIG. 20

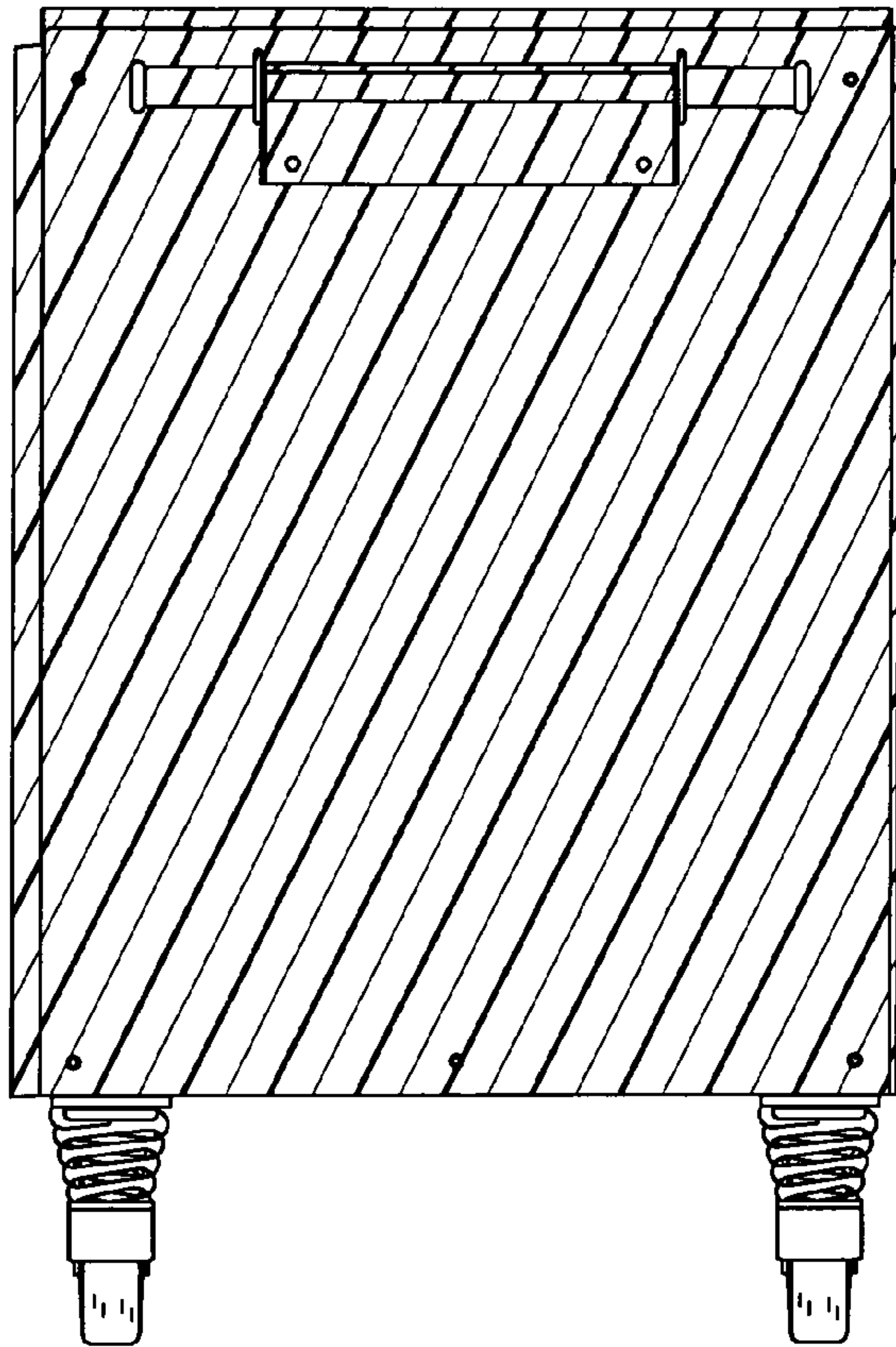

FIG. 21

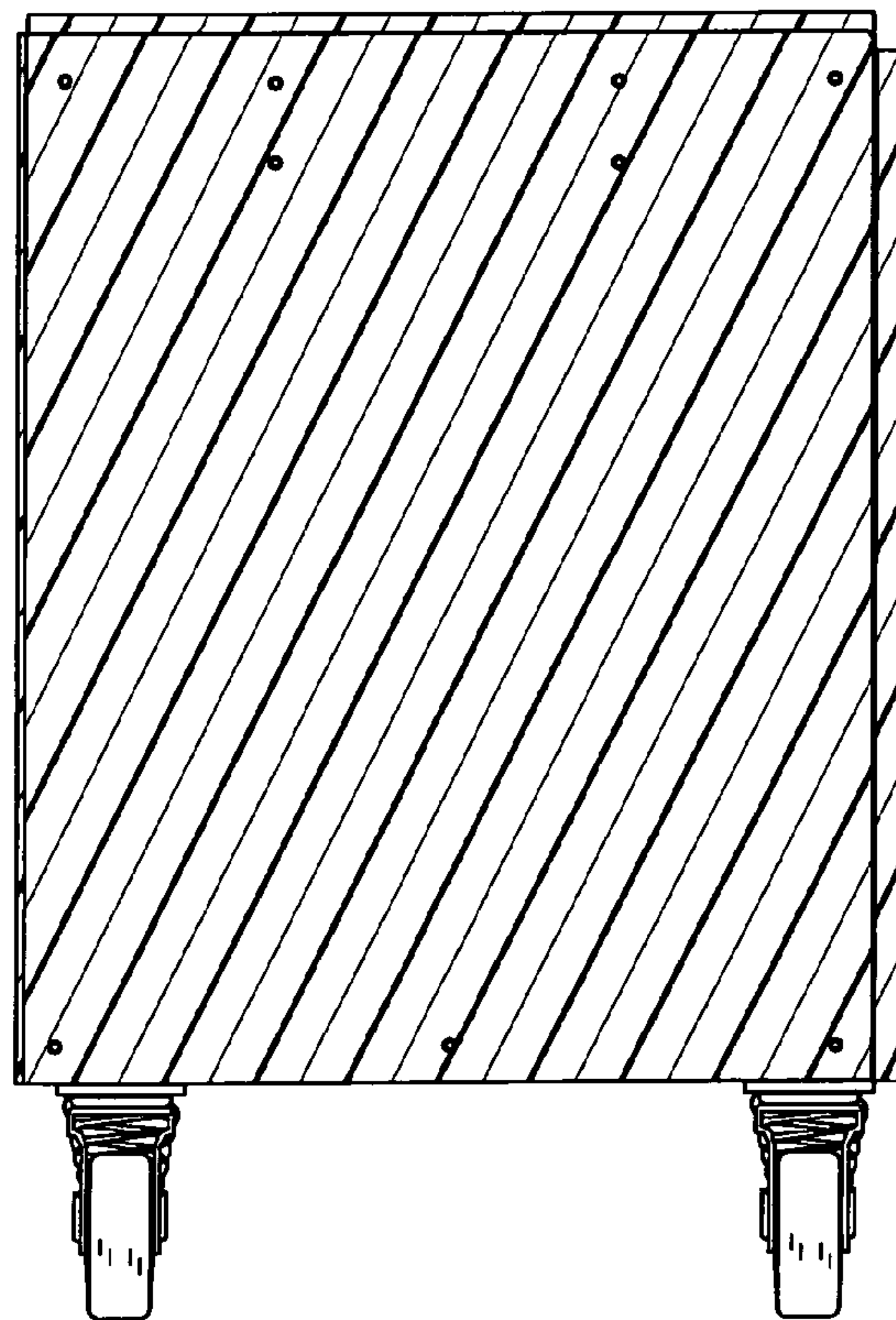

FIG. 22

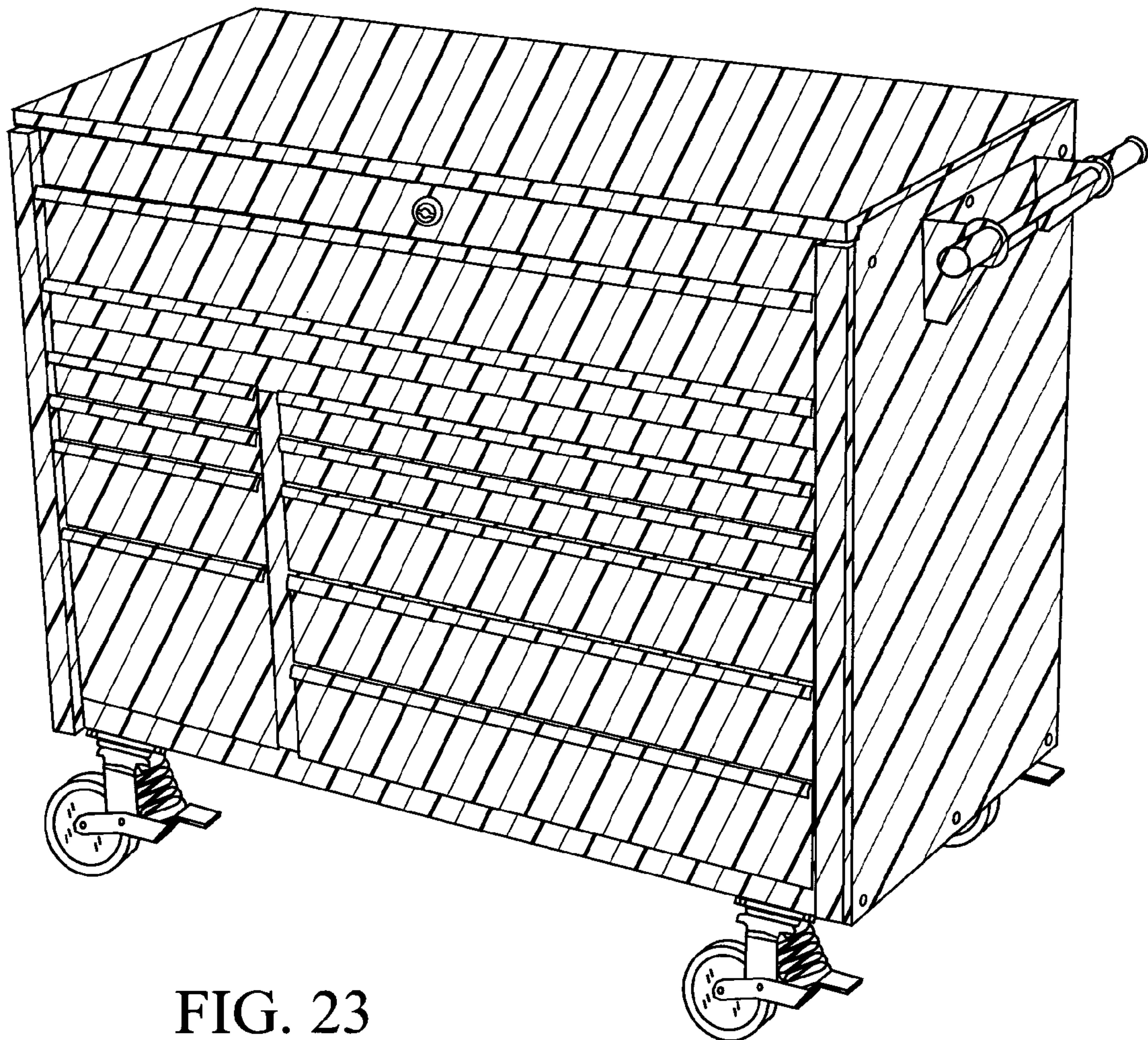

FIG. 23

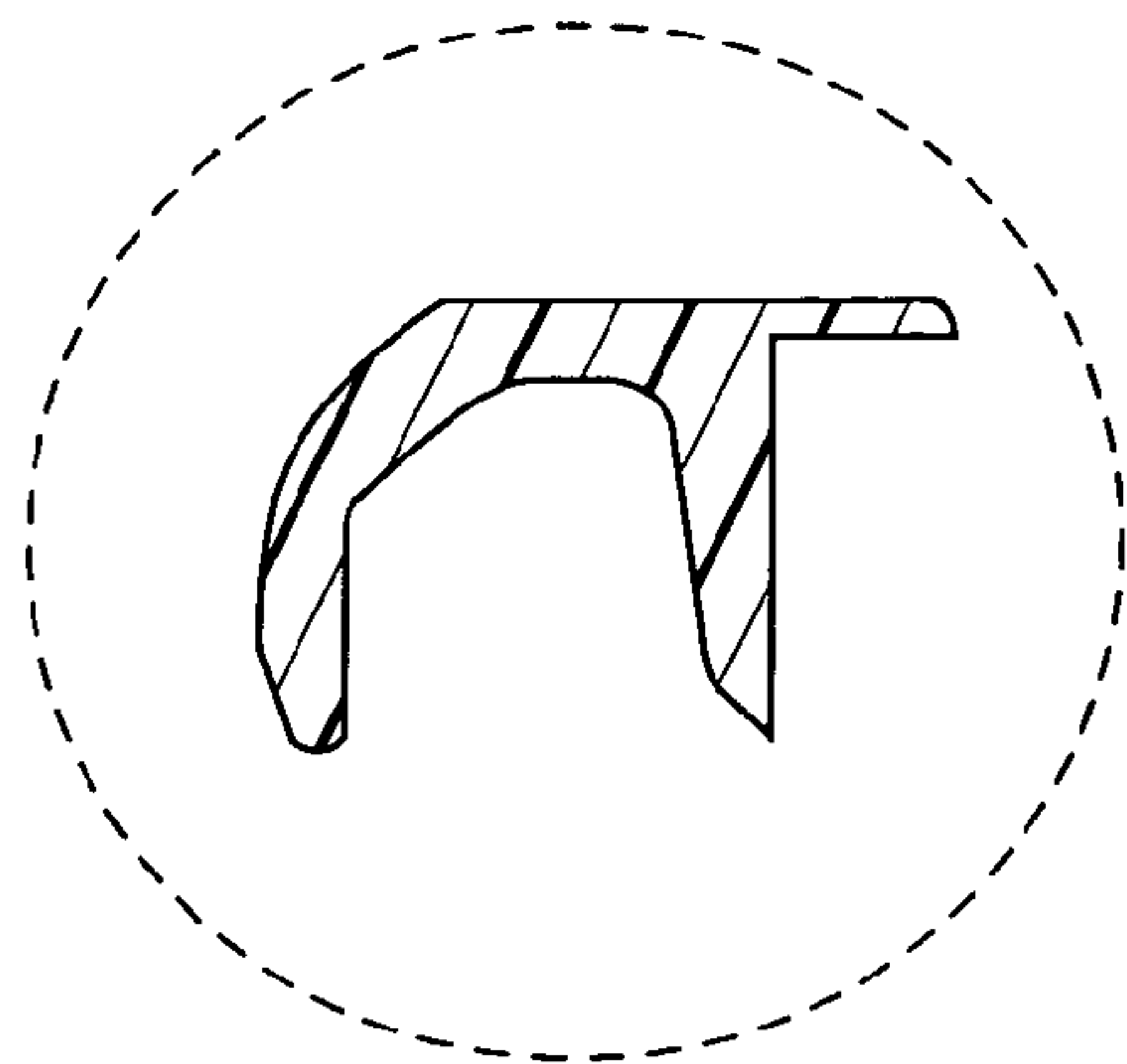

FIG. 24

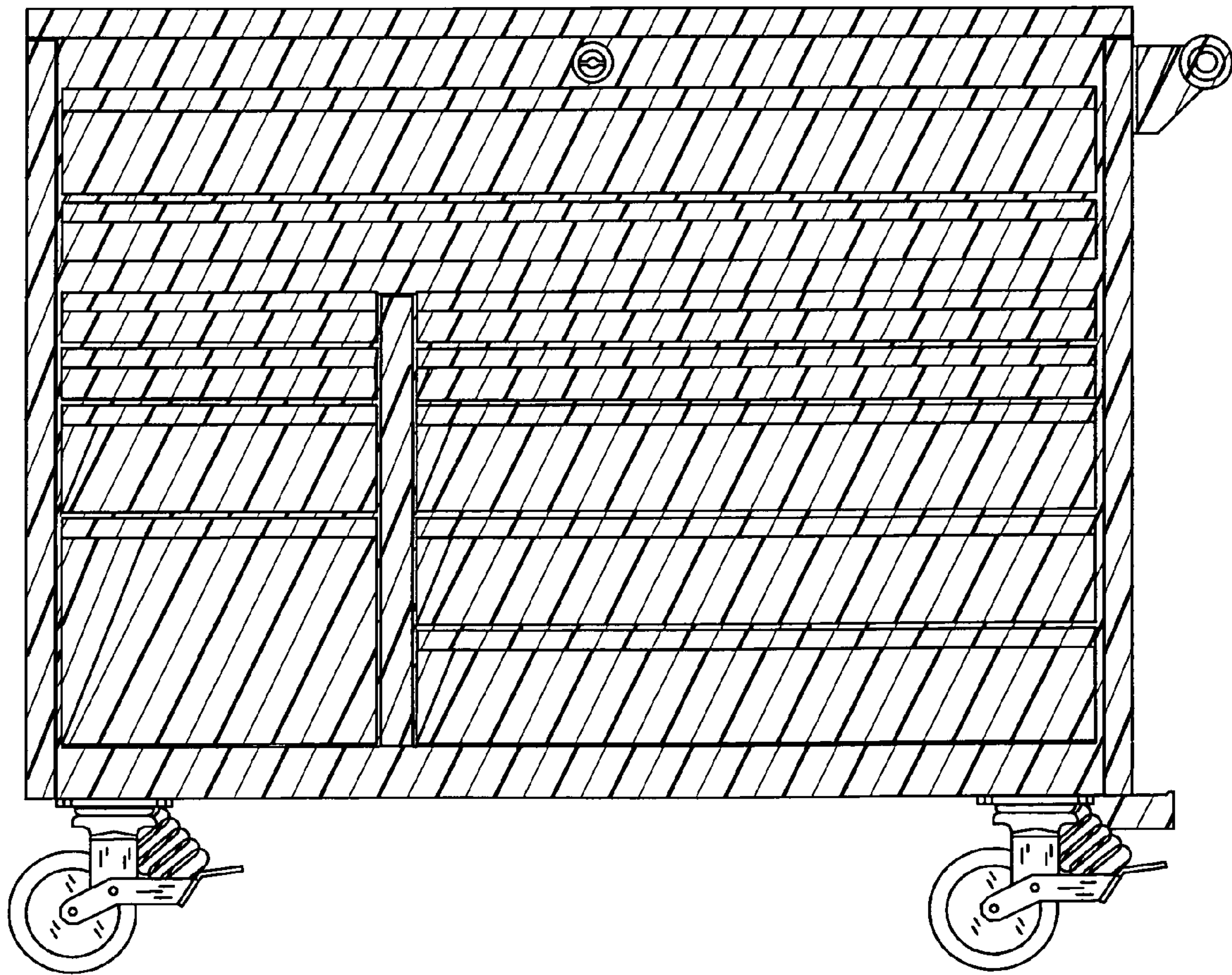

FIG. 25

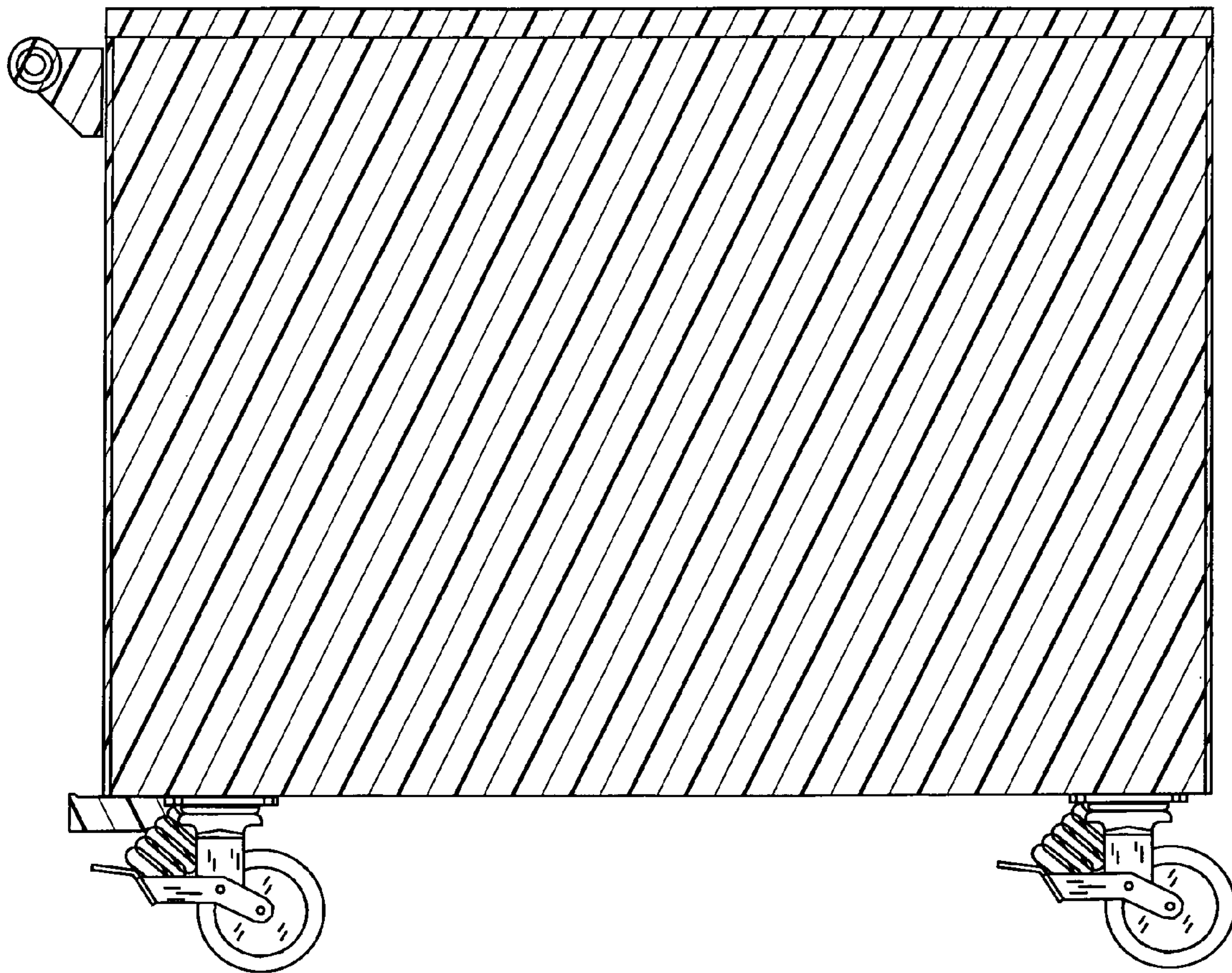

FIG. 26

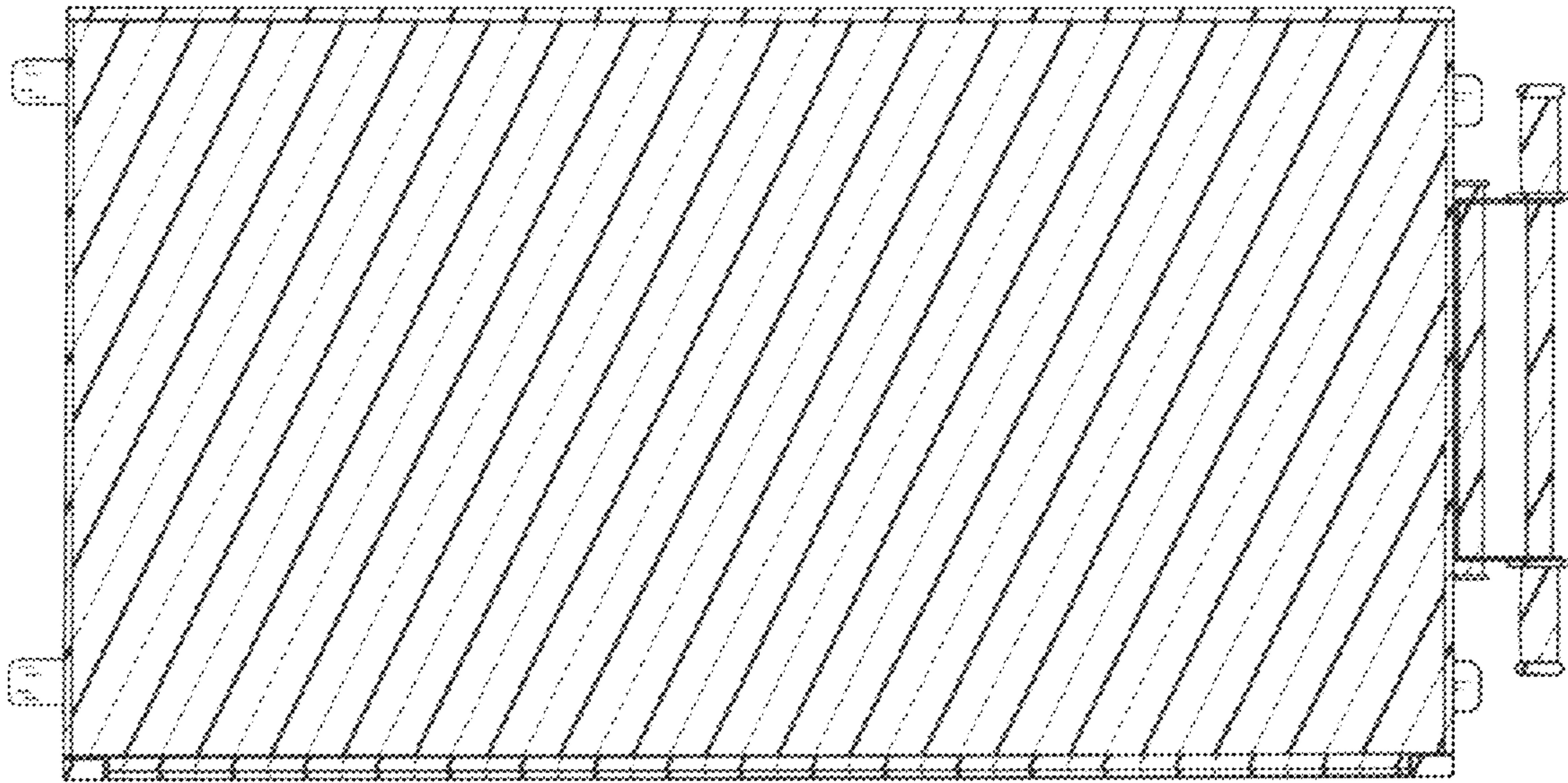

FIG. 27

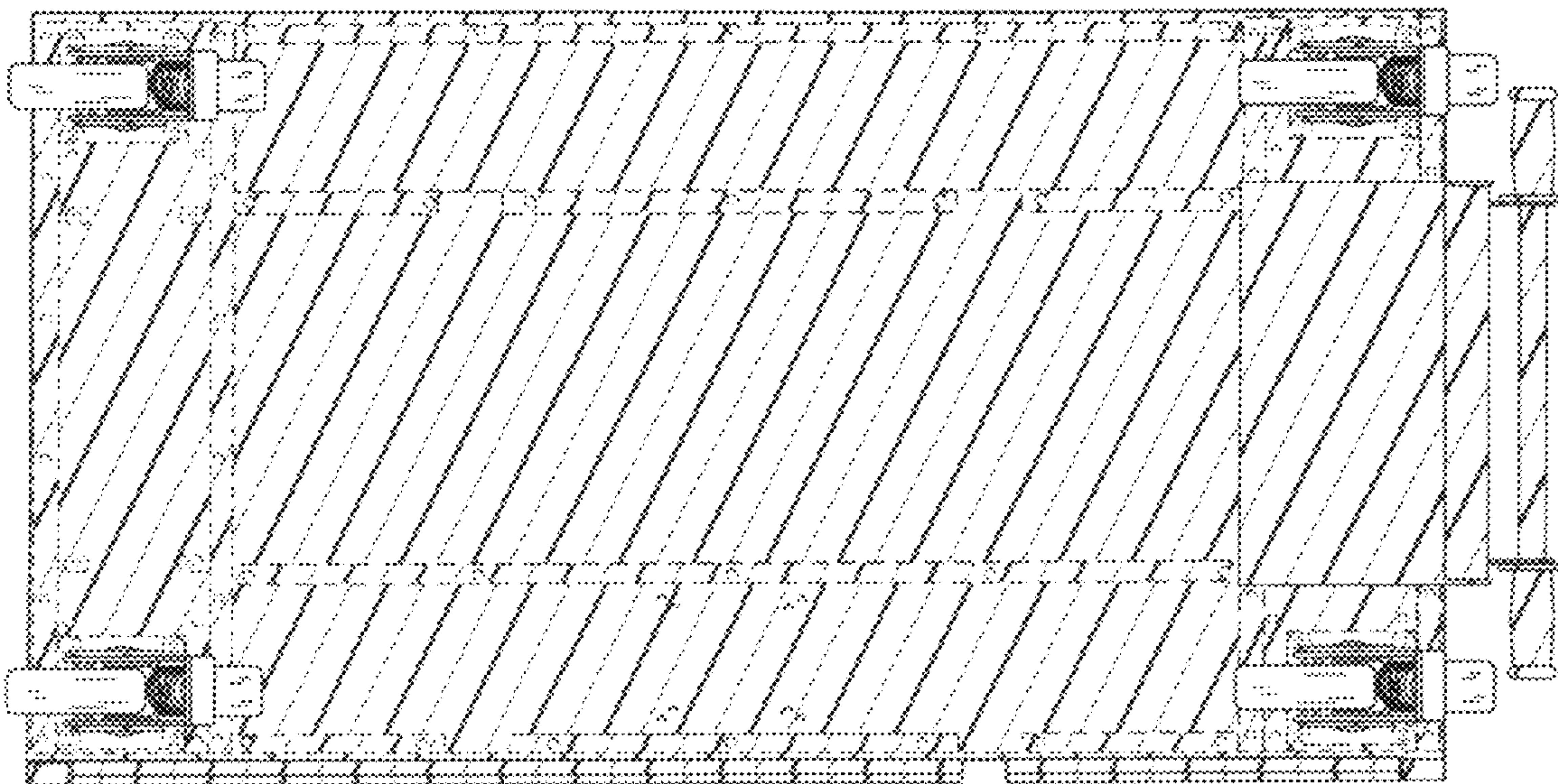

FIG. 28

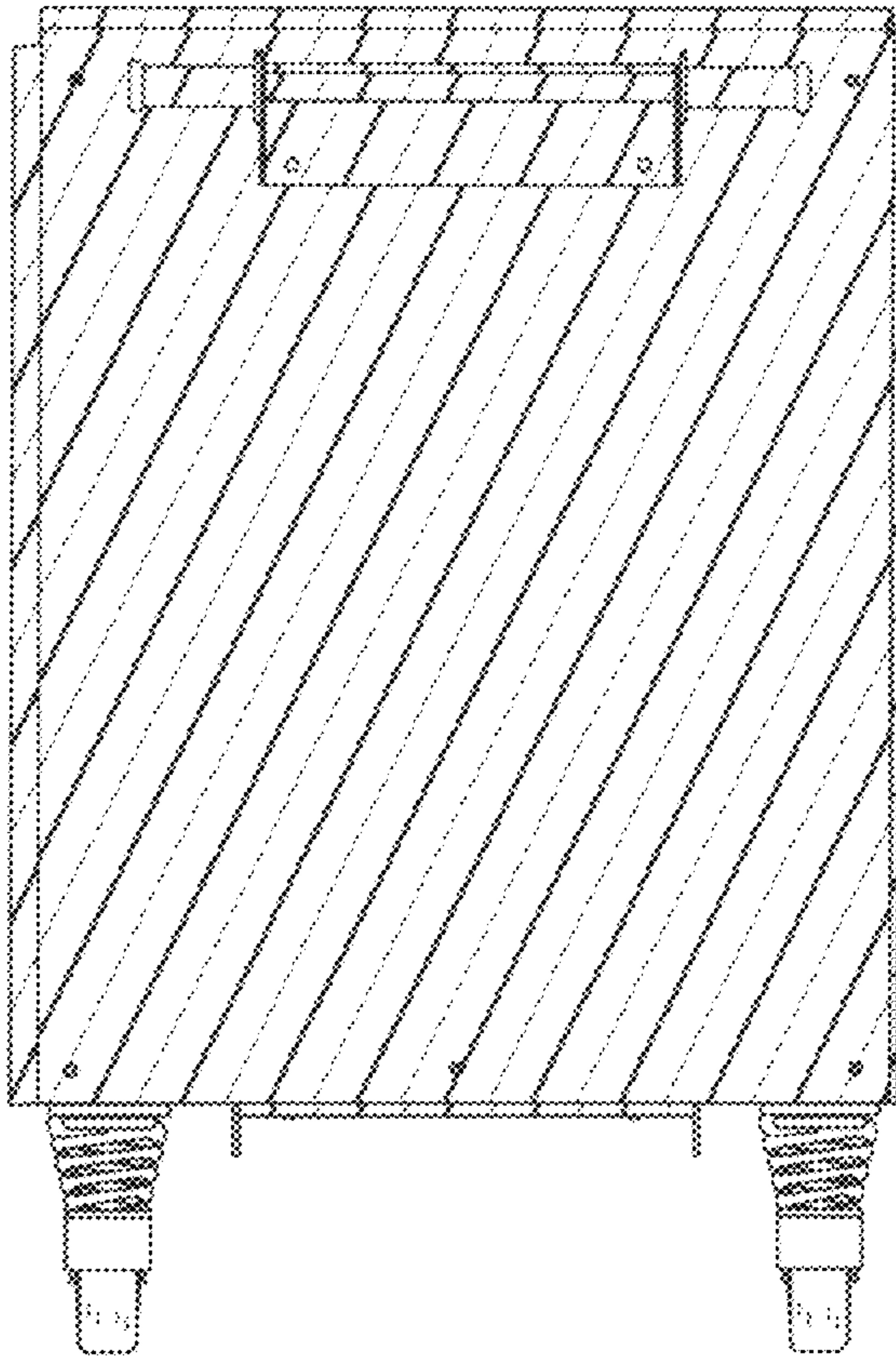

FIG. 29

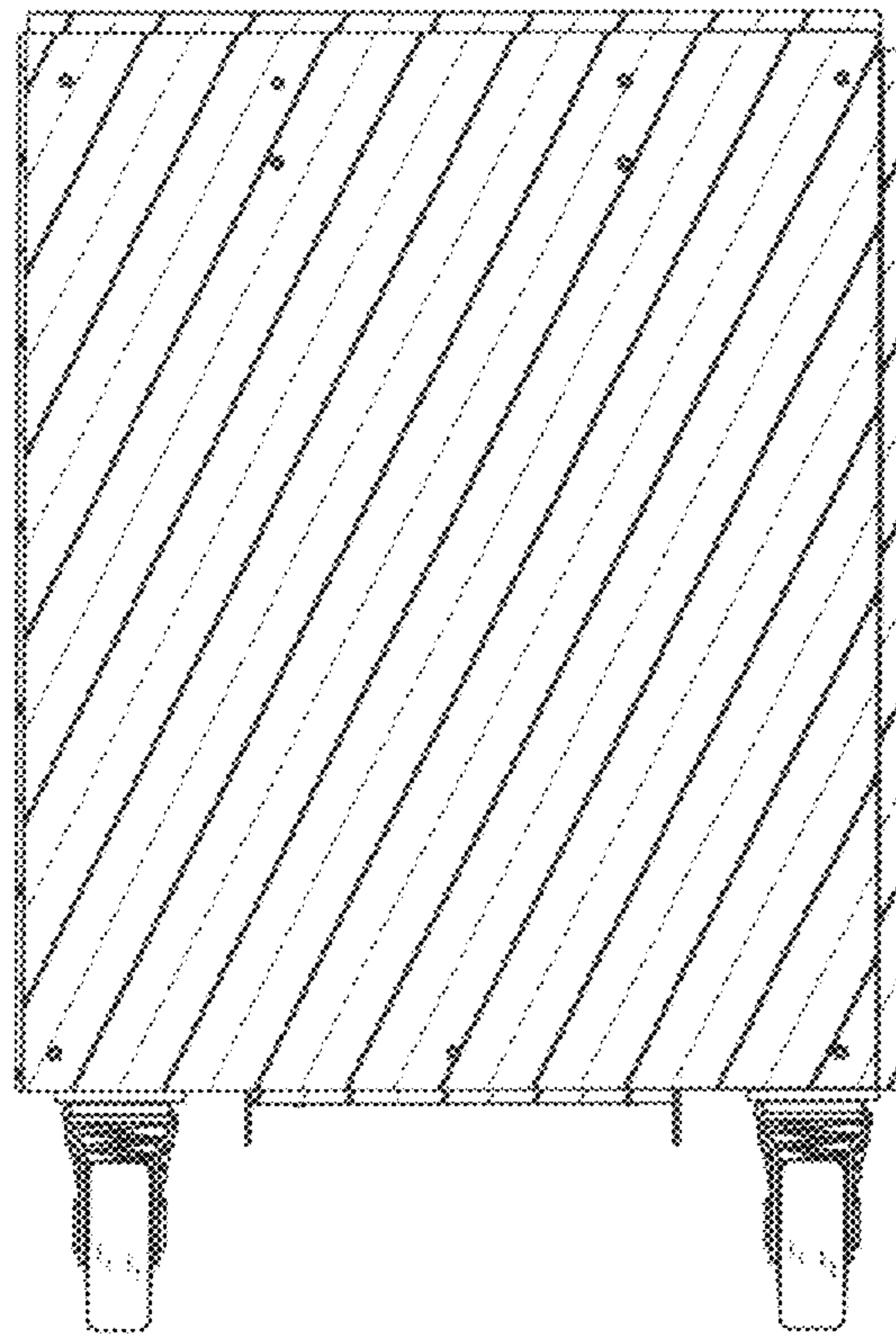

FIG. 30

