



US00D636522S

(12) **United States Design Patent**  
**Gutting**

(10) **Patent No.:** **US D636,522 S**  
(45) **Date of Patent:** **\*\* Apr. 19, 2011**

(54) **LUMINAIRE**

(75) Inventor: **David James Gutting**, Richmond, CA (US)

(73) Assignee: **Cooper Technologies Company**, Houston, TX (US)

(\*\*) Term: **14 Years**

(21) Appl. No.: **29/375,189**

(22) Filed: **Sep. 17, 2010**

(51) **LOC (9) Cl.** ..... **26-03**

(52) **U.S. Cl.** ..... **D26/88; D26/137**

(58) **Field of Classification Search** ..... D26/85, D26/87, 88, 90, 91, 118, 128-130, 137, 144; 362/147, 404-408, 431, 432

See application file for complete search history.

(56) **References Cited**

**U.S. PATENT DOCUMENTS**

D79,705 S \* 10/1929 Flood, Jr. .... D26/90  
(Continued)

**OTHER PUBLICATIONS**

Sundborn Collection light fixtures #42185/1 and 42186/1 shown on p. 413 of the E.L.K. Lighting catalog 2900. © 2009. (2 pages).\*

(Continued)

*Primary Examiner* — Clare E Heflin

(74) *Attorney, Agent, or Firm* — King & Spalding LLP

(57) **CLAIM**

The ornamental design for a luminaire, as shown and described.

**DESCRIPTION**

FIG. 1 is a perspective view of a luminaire, showing our new design;

FIG. 2 is a front elevation view thereof;

FIG. 3 is a rear elevation view thereof;

FIG. 4 is a right-side elevation view thereof;

FIG. 5 is a left-side elevation view thereof;

FIG. 6 is a bottom plan view thereof;

FIG. 7 is a top plan view thereof;

FIG. 8 is a perspective view of another embodiment of the new design for a luminaire;

FIG. 9 is a front elevation view of the luminaire of FIG. 8;

FIG. 10 is a rear elevation view of the luminaire of FIG. 8;

FIG. 11 is a right-side elevation view of the luminaire of FIG. 8;

FIG. 12 is a left-side elevation view of the luminaire of FIG. 8;

FIG. 13 is a bottom plan view of the luminaire of FIG. 8;

FIG. 14 is a top plan view of the luminaire of FIG. 8;

FIG. 15 is a perspective view of another embodiment of the new design for a luminaire;

FIG. 16 is a front elevation view of the luminaire of FIG. 15;

FIG. 17 is a rear elevation view of the luminaire of FIG. 15;

FIG. 18 is a right-side elevation view of the luminaire of FIG. 15;

FIG. 19 is a left-side elevation view of the luminaire of FIG. 15;

FIG. 20 is a bottom plan view of the luminaire of FIG. 15;

FIG. 21 is a top plan view of the luminaire of FIG. 15;

FIG. 22 is a perspective view of another embodiment of the new design for a luminaire;

FIG. 23 is a front elevation view of the luminaire of FIG. 22;

FIG. 24 is a rear elevation view of the luminaire of FIG. 22;

FIG. 25 is a right-side elevation view of the luminaire of FIG. 22;

FIG. 26 is a left-side elevation view of the luminaire of FIG. 22;

FIG. 27 is a bottom plan view of the luminaire of FIG. 22;

FIG. 28 is a top plan view of the luminaire of FIG. 22;

FIG. 29 is a perspective view of another embodiment of the new design for a luminaire;

FIG. 30 is a front elevation view of the luminaire of FIG. 29;

FIG. 31 is a rear elevation view of the luminaire of FIG. 29;

FIG. 32 is a right-side elevation view of the luminaire of FIG. 29;

FIG. 33 is a left-side elevation view of the luminaire of FIG. 29;

FIG. 34 is a bottom plan view of the luminaire of FIG. 29;

FIG. 35 is a top plan view of the luminaire of FIG. 29;

FIG. 36 is a perspective view of another embodiment of the new design for a luminaire;

FIG. 37 is a front elevation view of the luminaire of FIG. 36;

FIG. 38 is a rear elevation view of the luminaire of FIG. 36;

FIG. 39 is a right-side elevation view of the luminaire of FIG. 36;

FIG. 40 is a left-side elevation view of the luminaire of FIG. 36;

FIG. 41 is a bottom plan view of the luminaire of FIG. 36; and, FIG. 42 is a top plan view of the luminaire of FIG. 36.

The broken lines shown represent unclaimed subject matter and form no part of the claimed design.

**1 Claim, 42 Drawing Sheets**

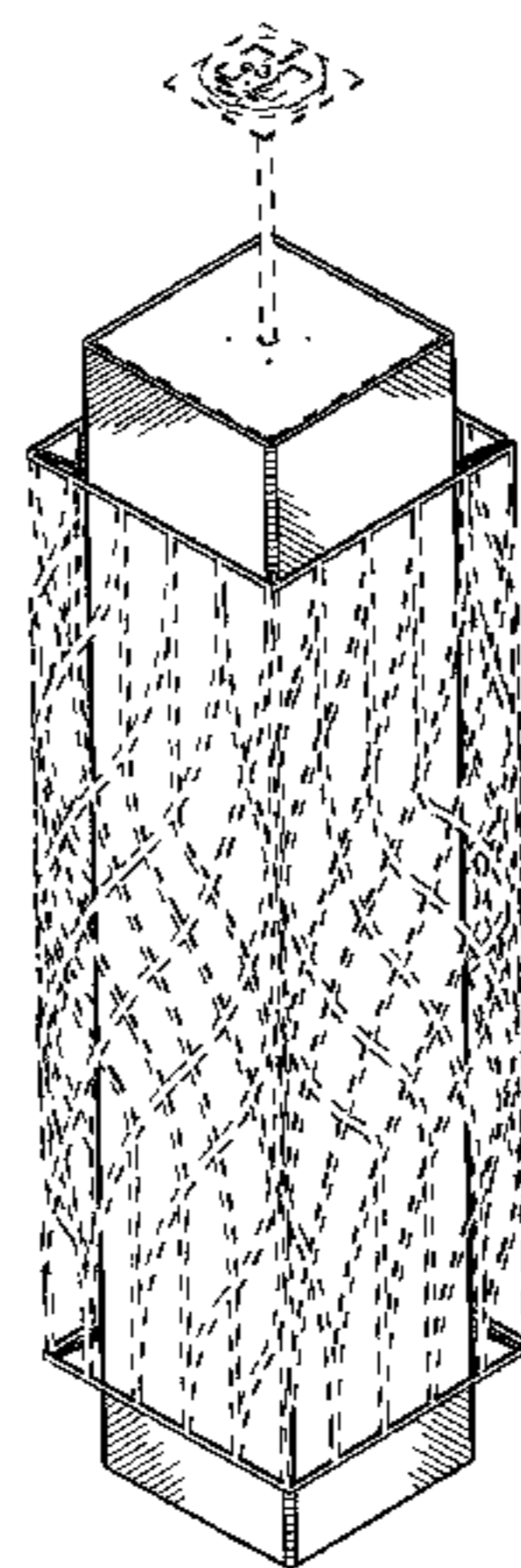

# US D636,522 S

Page 2

## U.S. PATENT DOCUMENTS

D160,809 S \* 11/1950 Schear et al. .... D26/85  
D162,723 S \* 4/1951 Gregg ..... D26/85  
D215,171 S \* 9/1969 Meltzer ..... D26/88  
D399,330 S \* 10/1998 Geier et al. .... D26/88  
D451,628 S \* 12/2001 Hutton ..... D26/110  
6,921,186 B1 \* 7/2005 Viskovich ..... 362/404  
D536,478 S \* 2/2007 McMinn ..... D26/118  
D544,637 S \* 6/2007 McMinn ..... D26/118  
D548,386 S \* 8/2007 McDowell ..... D26/118  
D548,387 S \* 8/2007 McDowell ..... D26/118  
D557,451 S \* 12/2007 McDowell ..... D26/118  
D561,928 S \* 2/2008 Silver ..... D26/88  
D563,590 S \* 3/2008 Hetfield et al. .... D26/88  
D564,696 S \* 3/2008 Hetfield et al. .... D26/88  
D574,545 S \* 8/2008 Baldele ..... D26/88  
D583,090 S \* 12/2008 Silver ..... D26/85

D585,583 S \* 1/2009 Campbell ..... D26/88  
D596,335 S \* 7/2009 Sabernig ..... D26/88  
D596,337 S \* 7/2009 Sabernig ..... D26/88  
D596,782 S \* 7/2009 Silver ..... D26/90  
D596,783 S \* 7/2009 Silver ..... D26/90  
D604,452 S \* 11/2009 Smith ..... D26/118  
D620,183 S \* 7/2010 Sabernig ..... D26/88  
D620,184 S \* 7/2010 Sabernig ..... D26/88

## OTHER PUBLICATIONS

Caledon pendant and wall mount shown on pp. 18 and 19 of the Eurofase Illuminations Catalog © 2009. (1 page).\*

Saadia pendant on p. 28; and Ayako pendant on p. 29 of the Eurofase Illuminations Catalog © 2009. (1 page).\*

Rear cover of the Eurofase Illuminations catalog. © 2009. (1 page).\*

\* cited by examiner

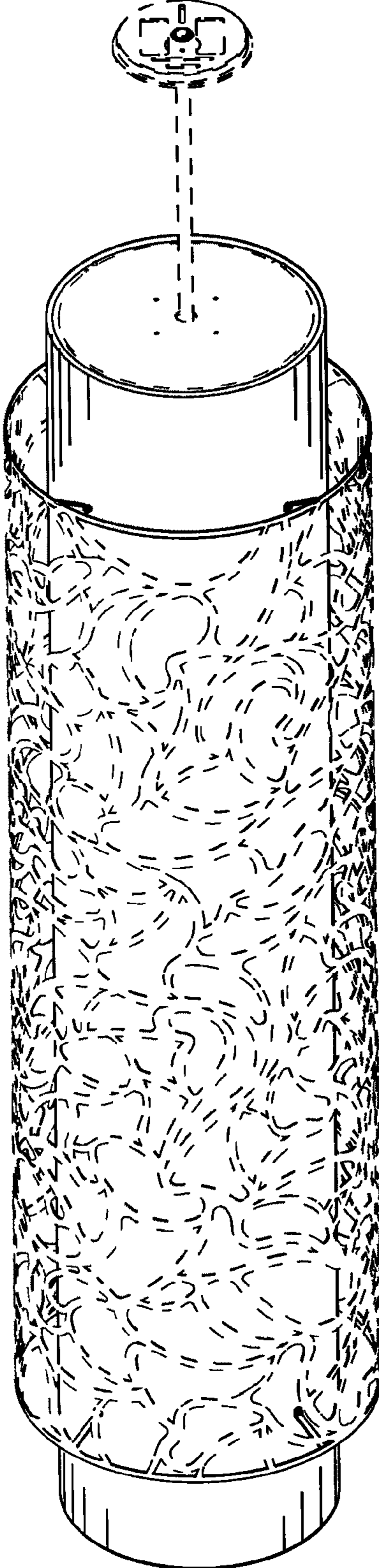

FIG. 1

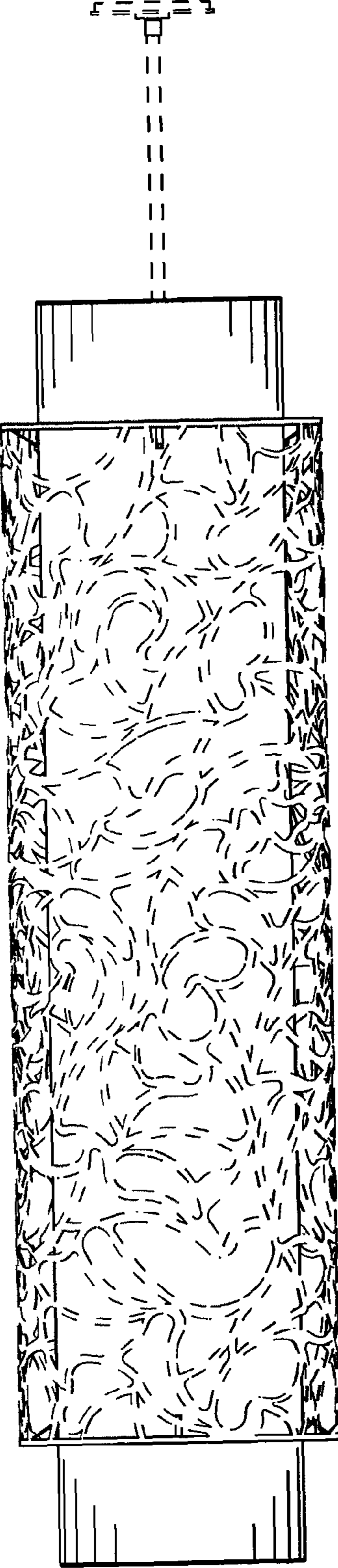

FIG.2

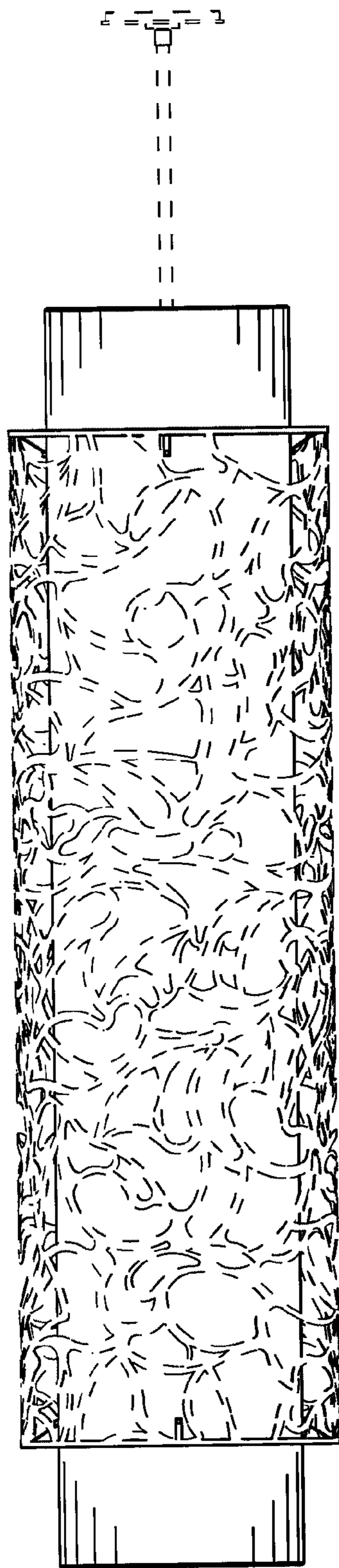

FIG.3

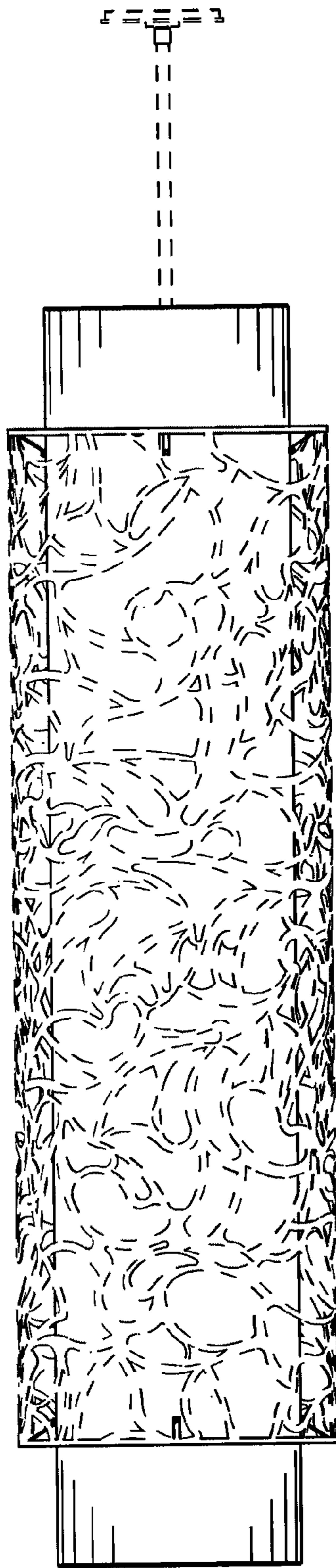

FIG.4

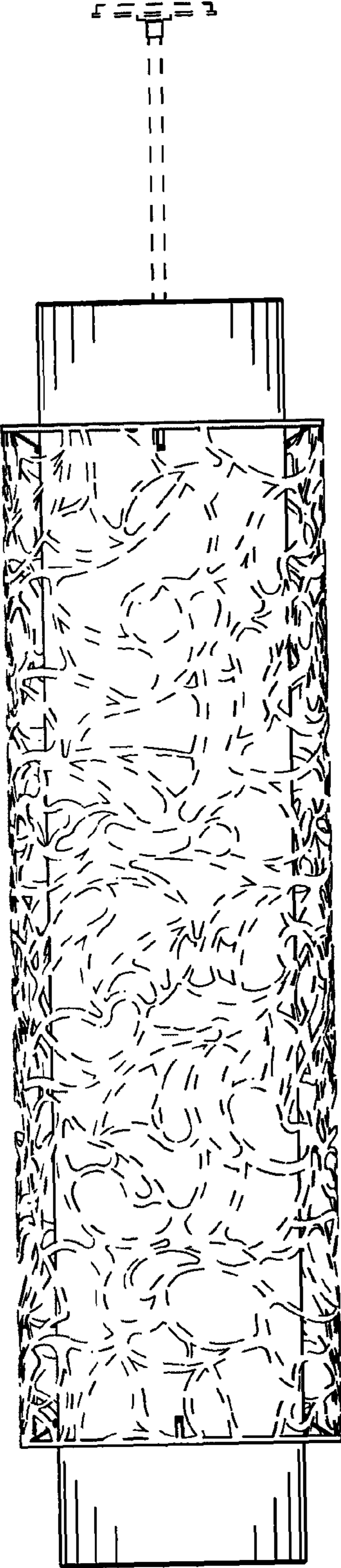
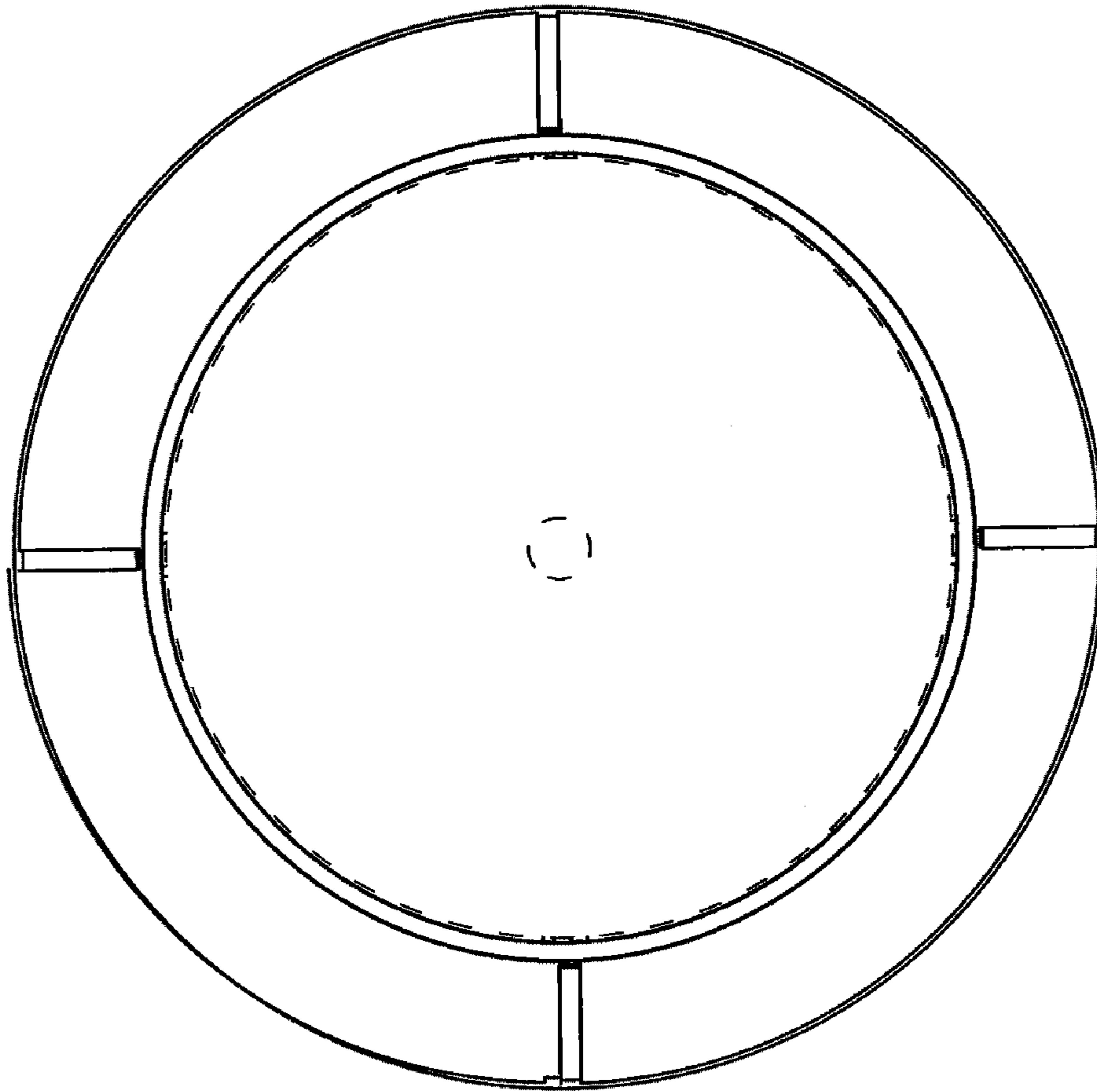

FIG.5



**FIG.6**



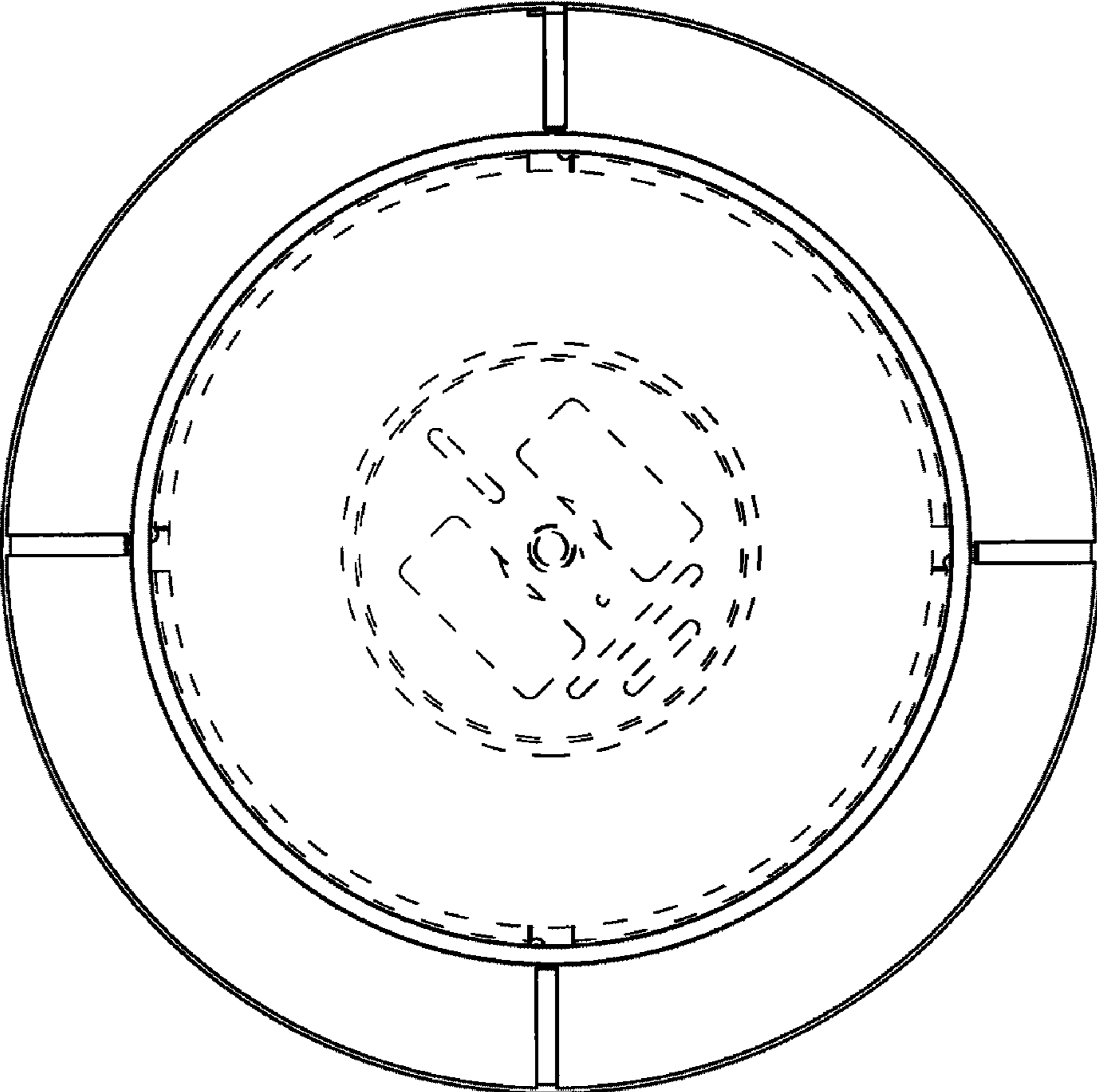

FIG.7

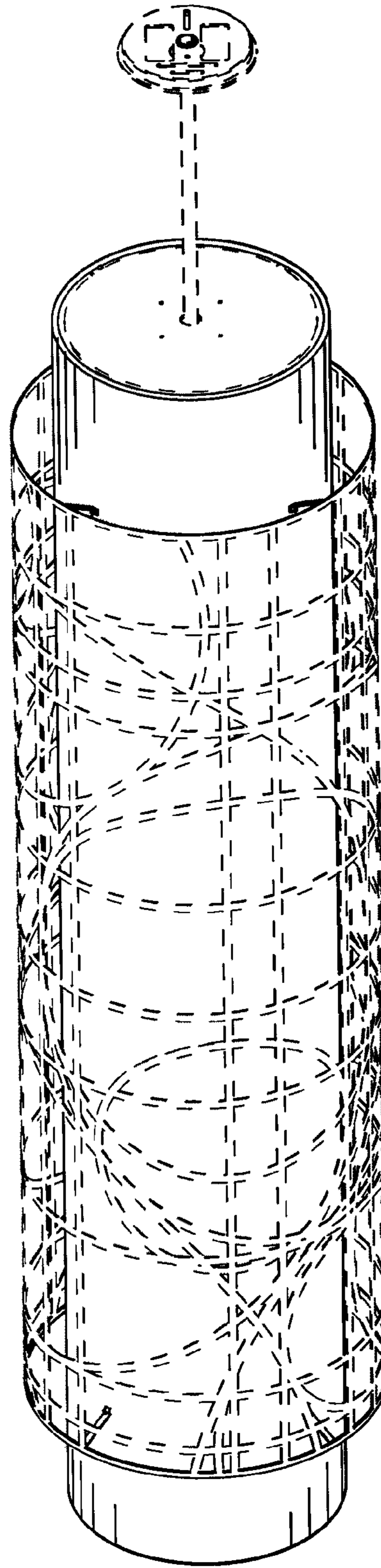

FIG. 8

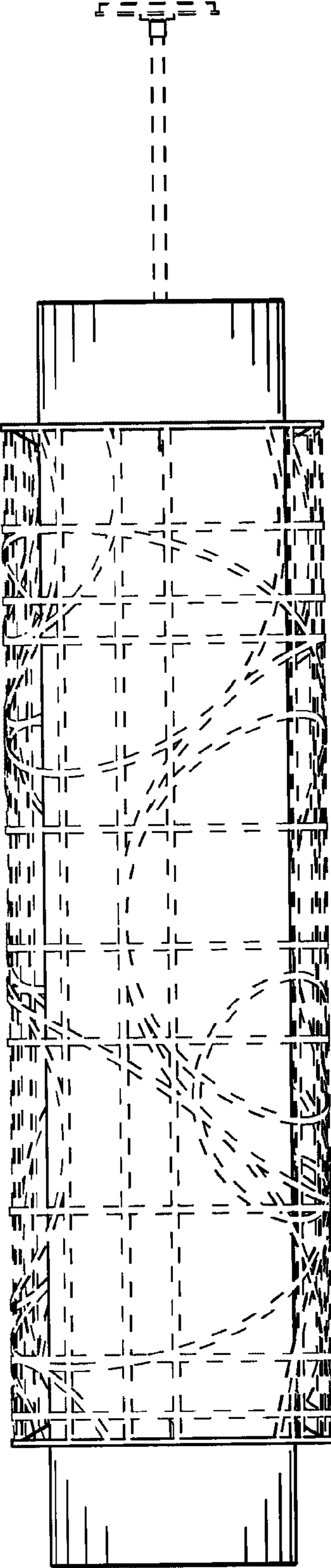

FIG.9

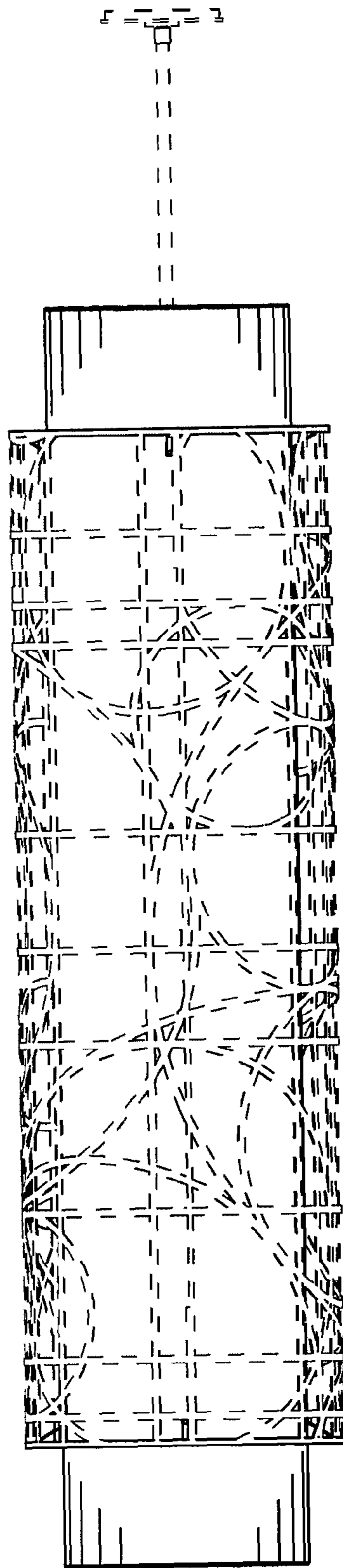

FIG.10

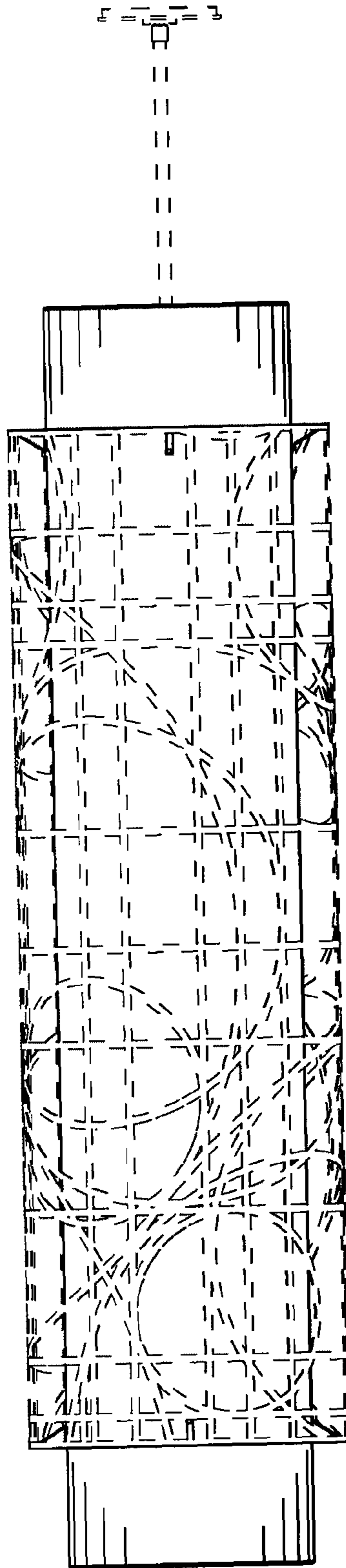

FIG.11

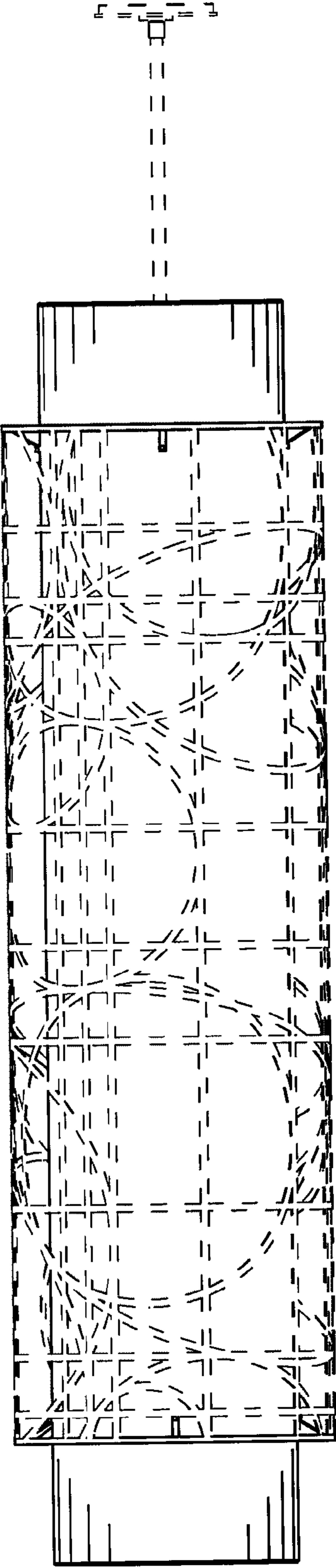
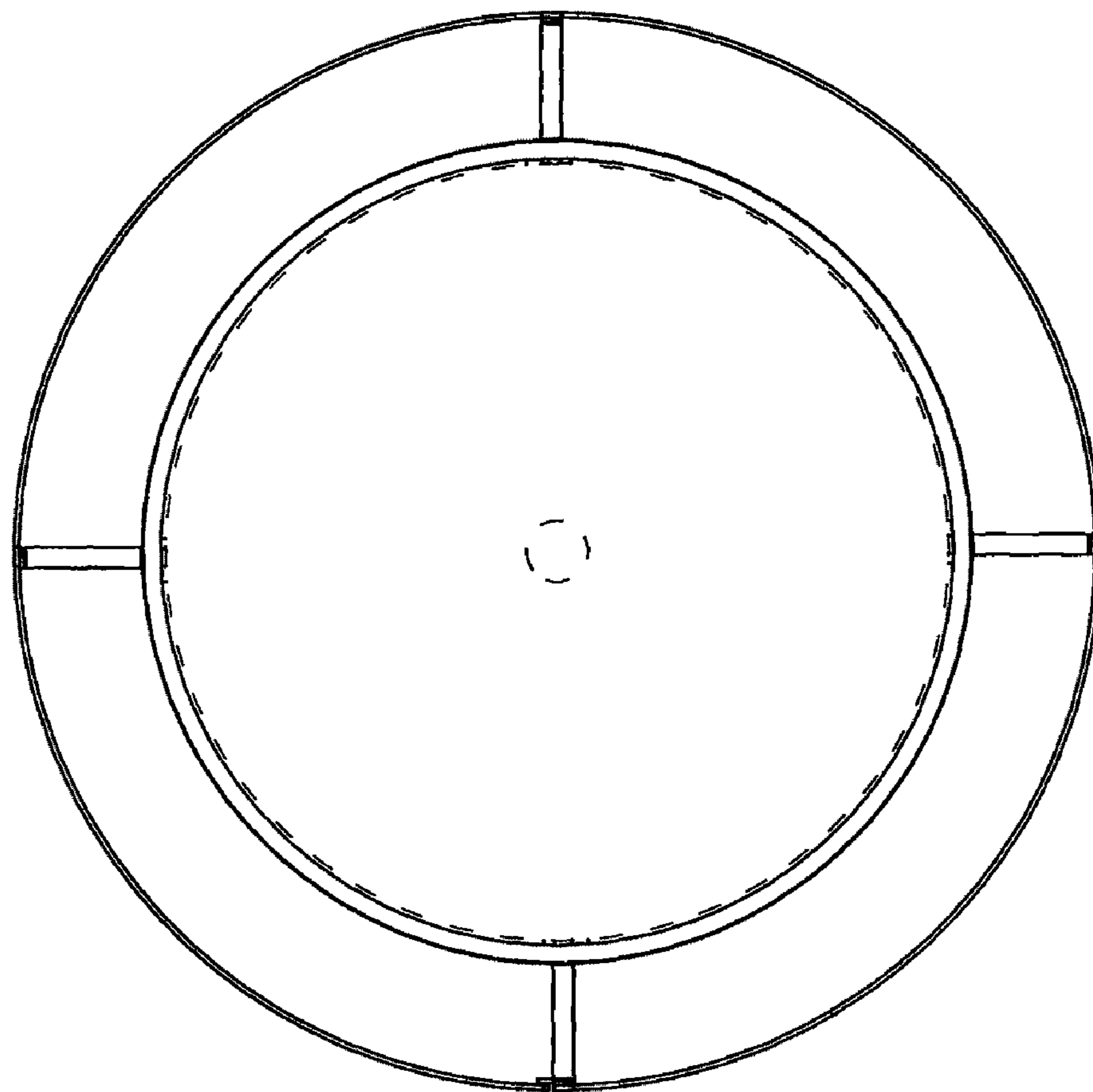
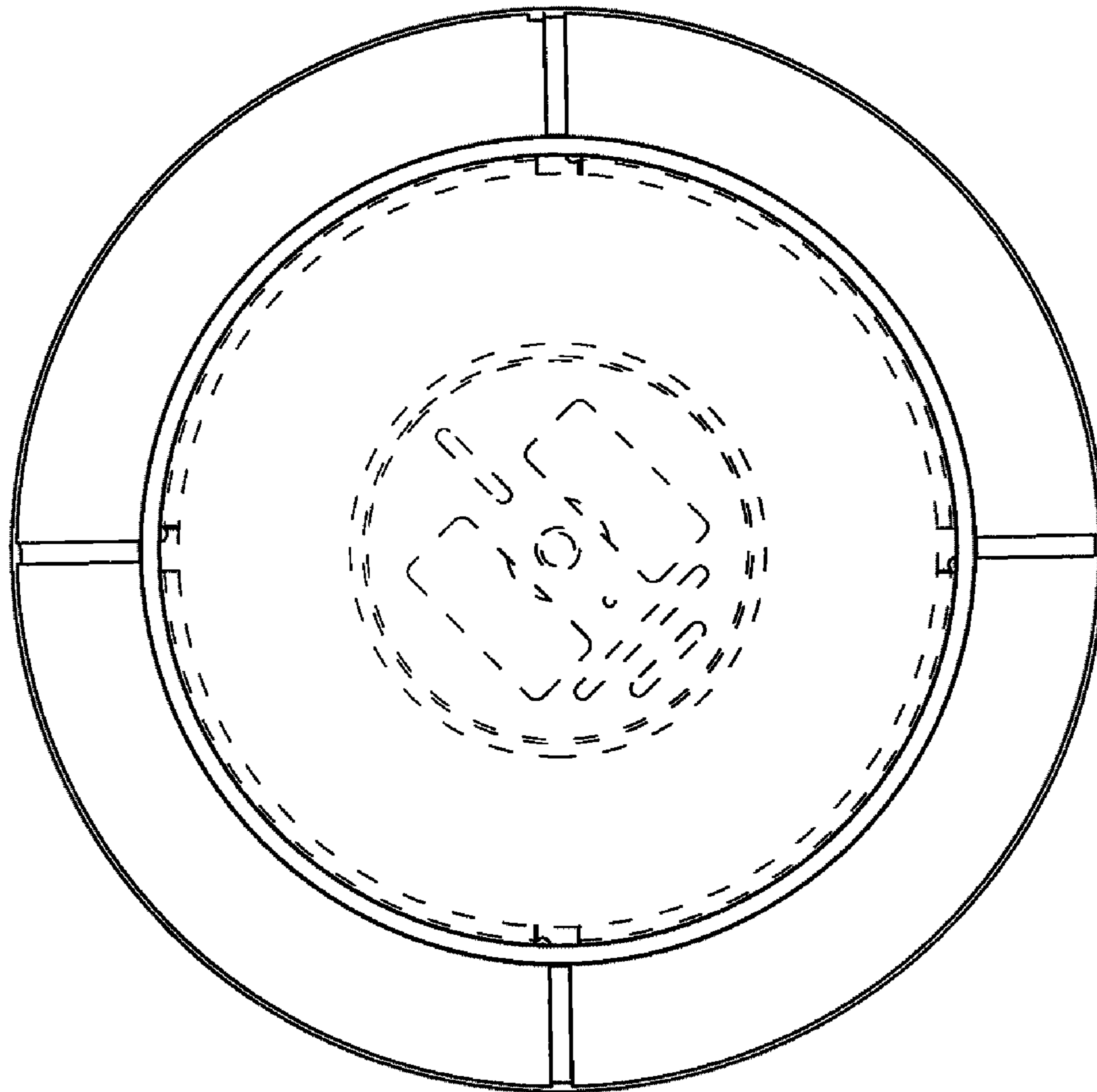

FIG.12



**FIG.13**



**FIG.14**



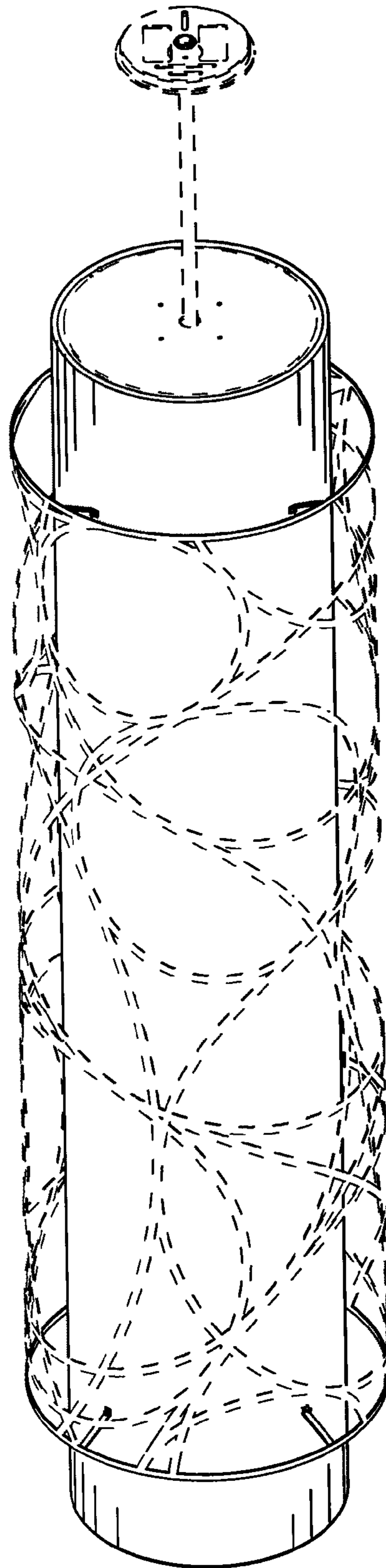

FIG.15

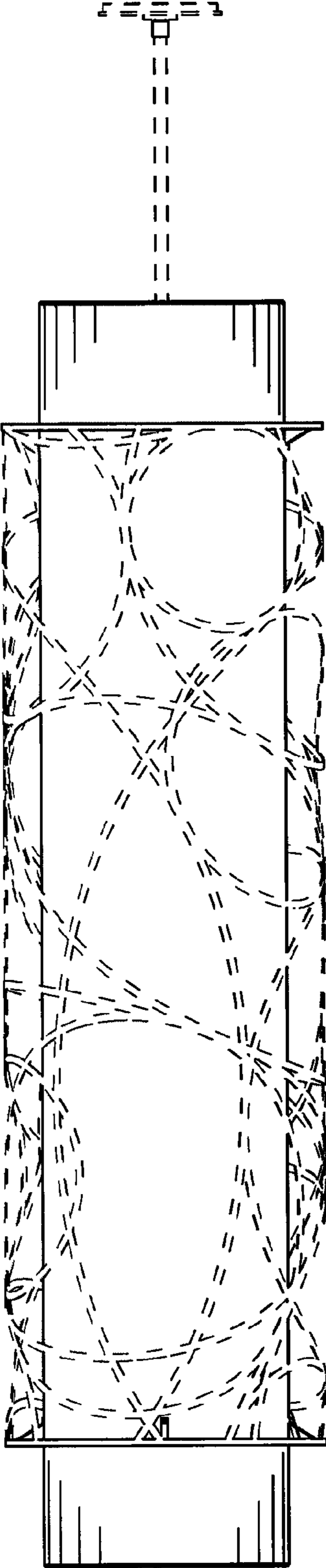

FIG.16

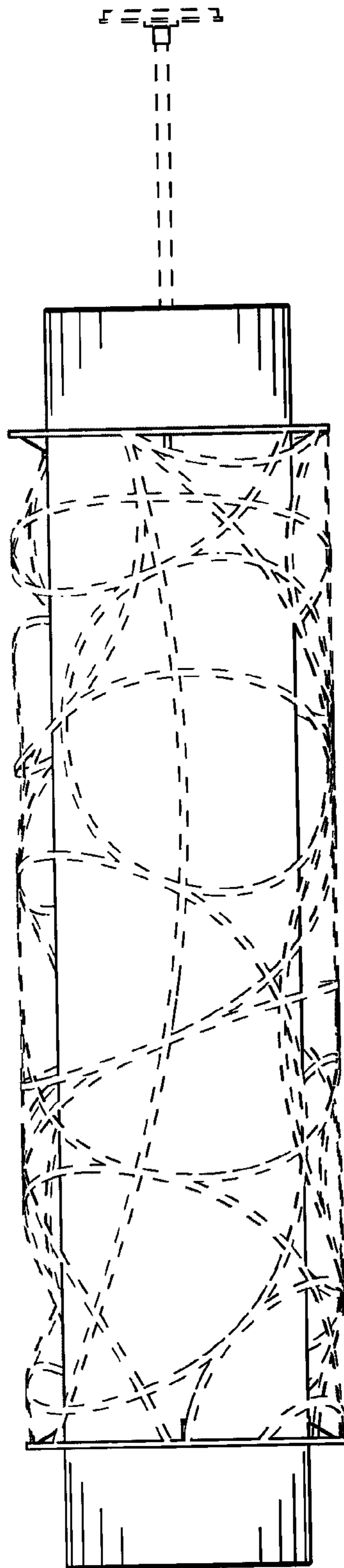

FIG.17

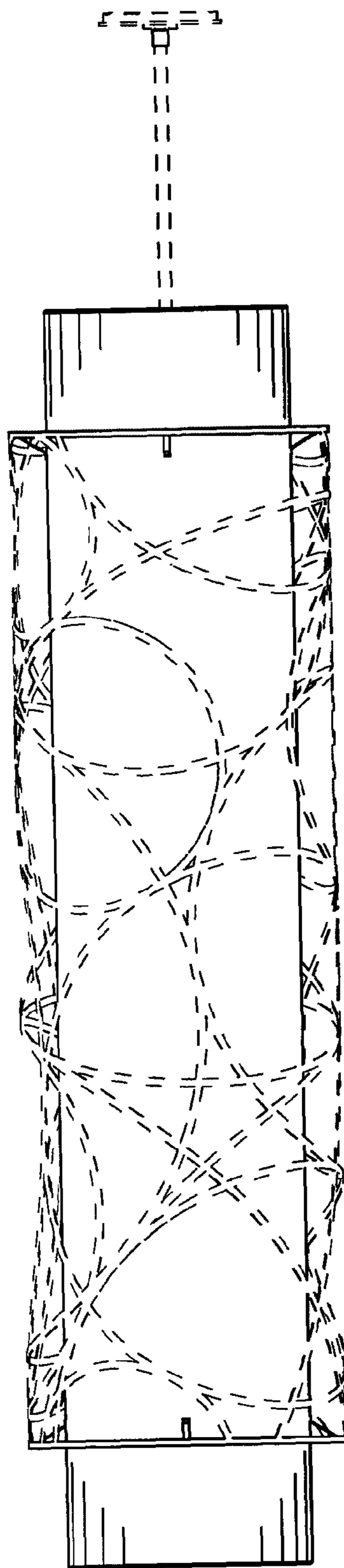

FIG.18

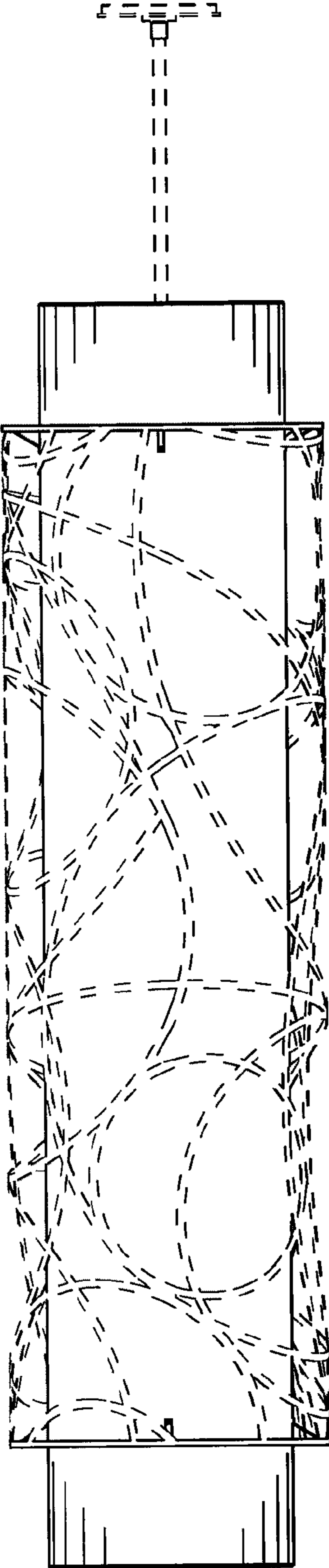
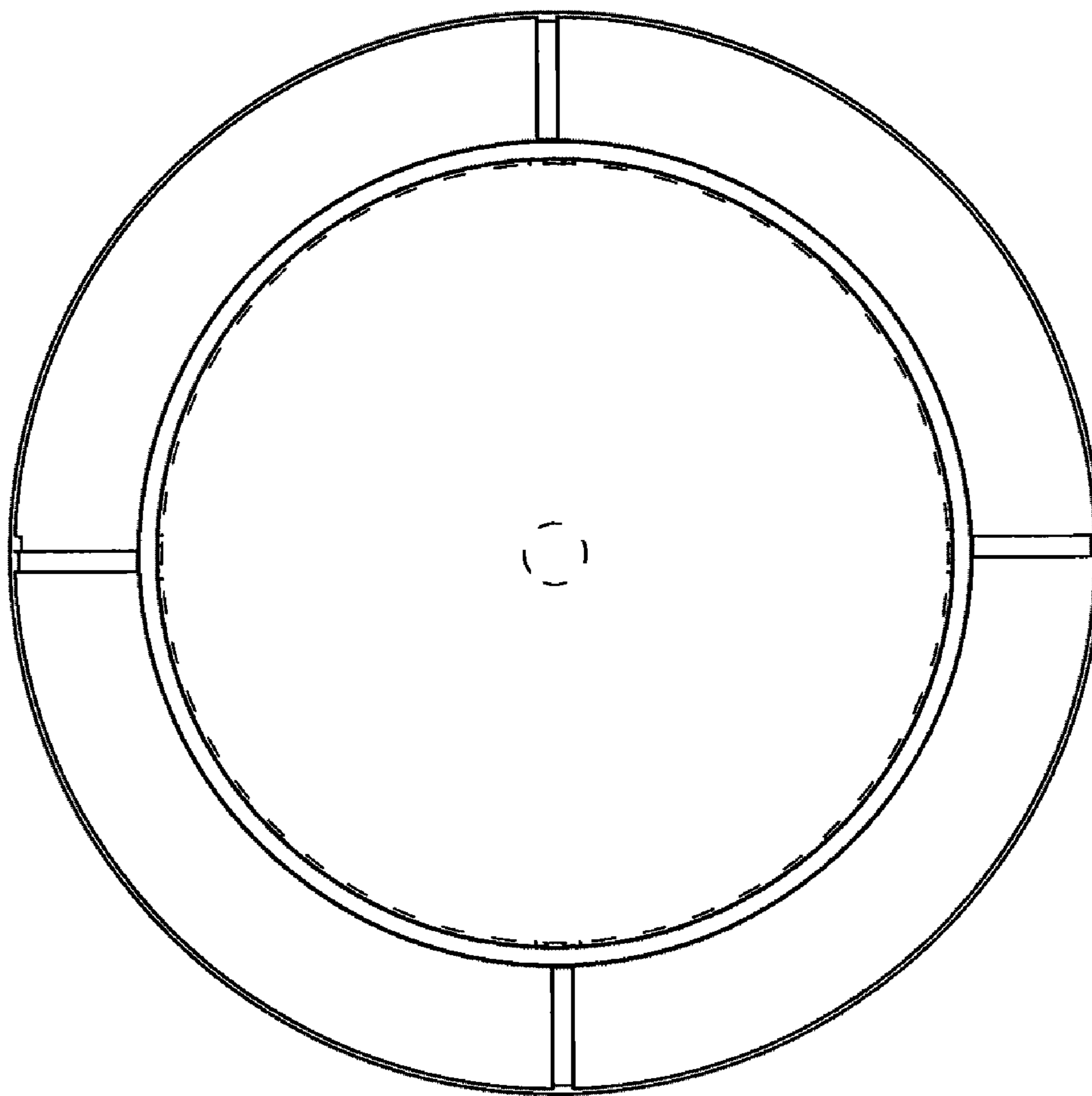

FIG.19



**FIG.20**

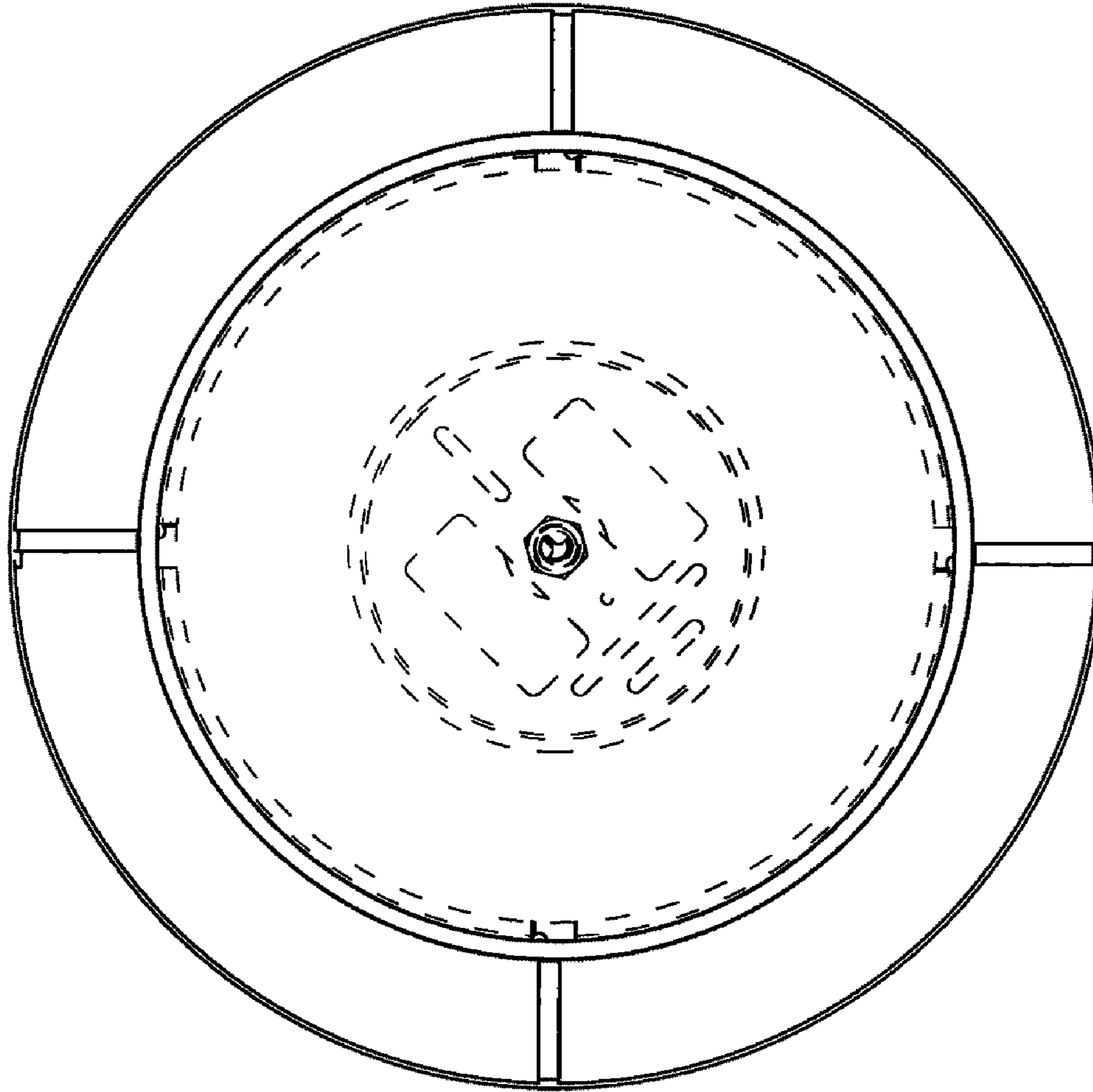

FIG.21

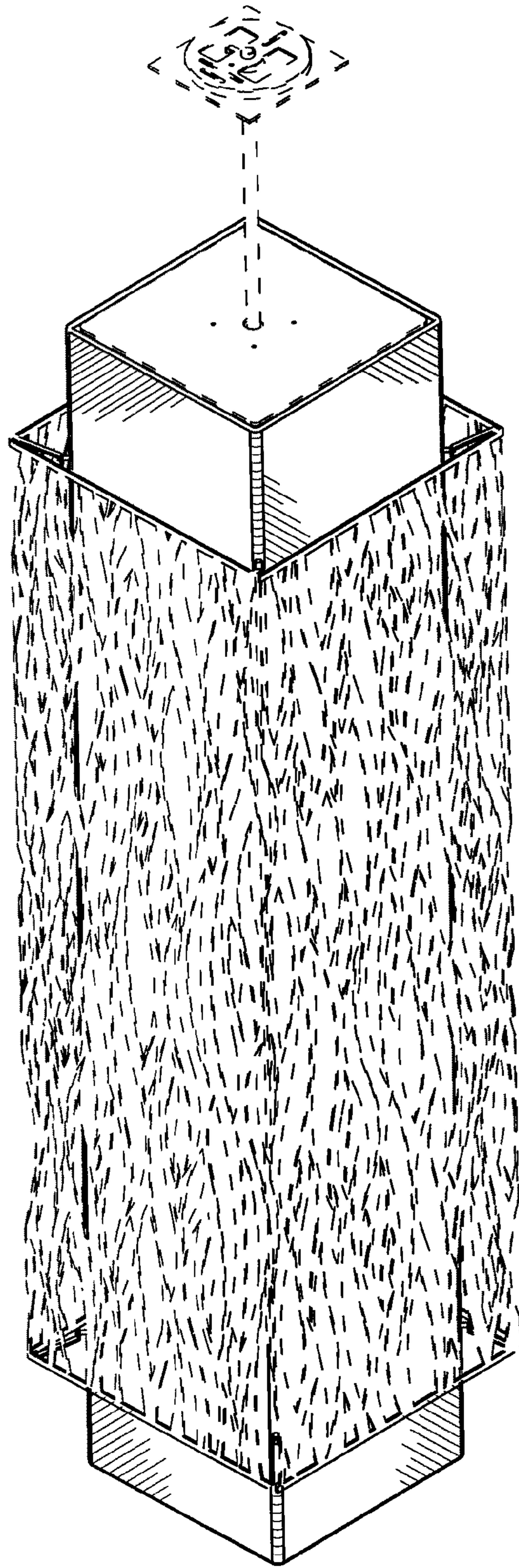

FIG.22



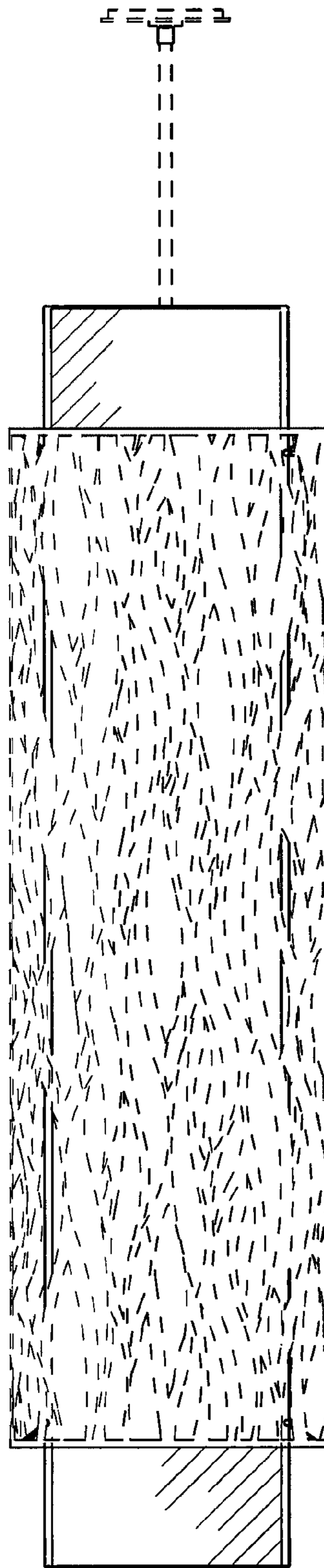

FIG.23

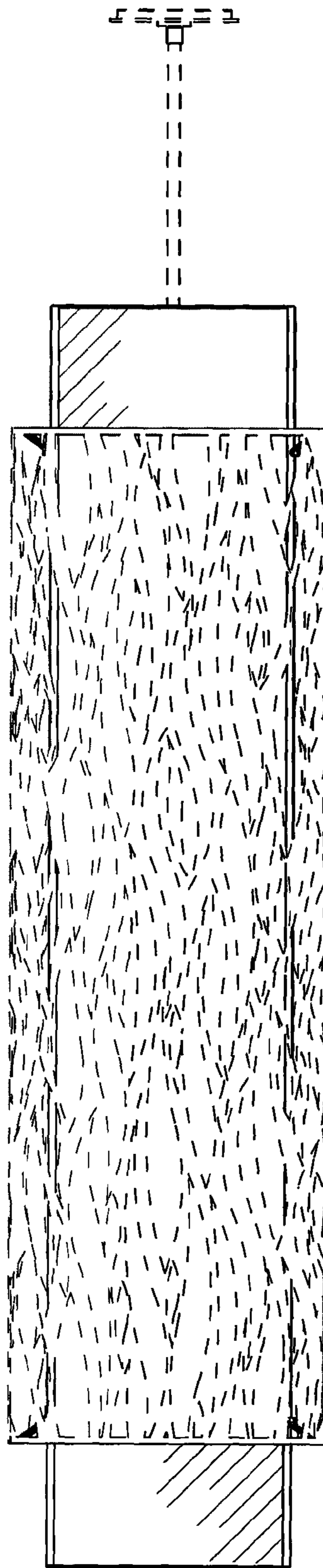

FIG.24

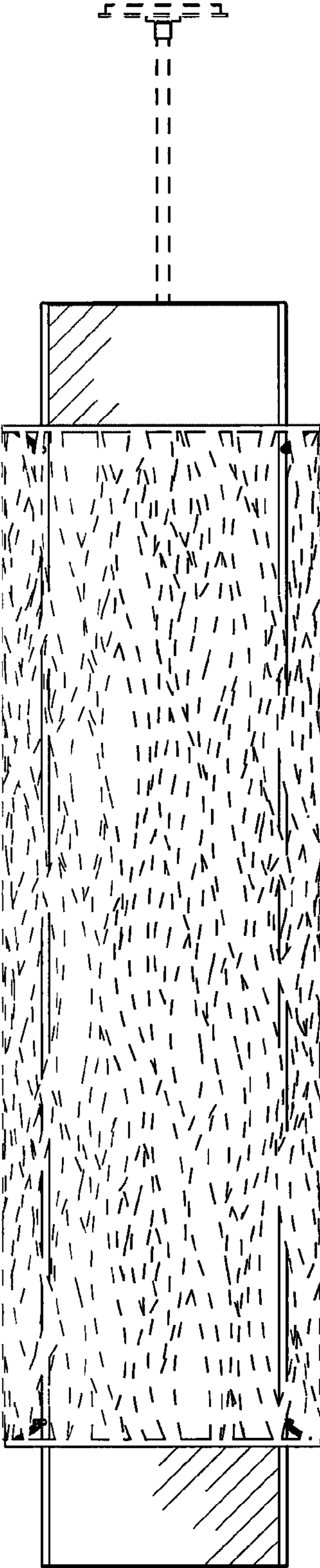

FIG.25

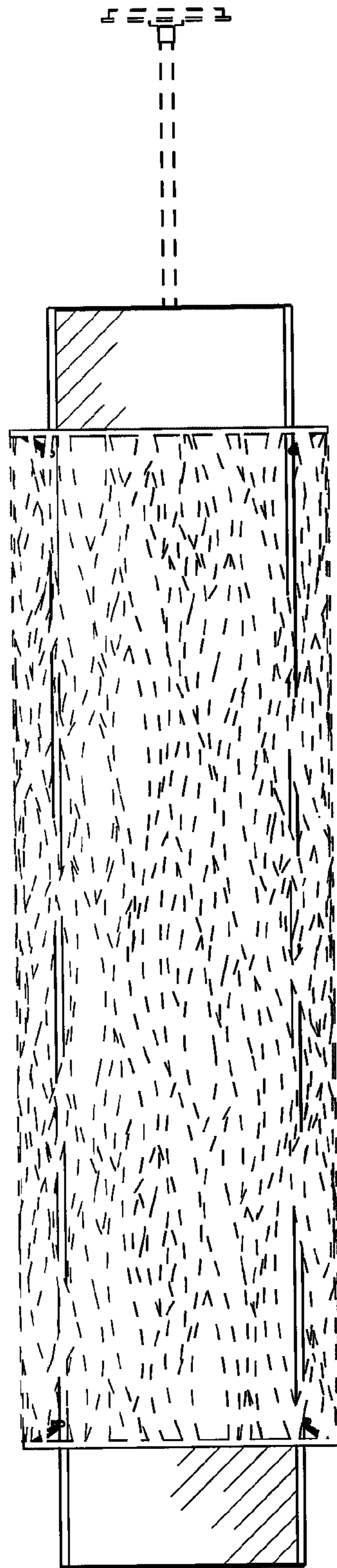

FIG.26

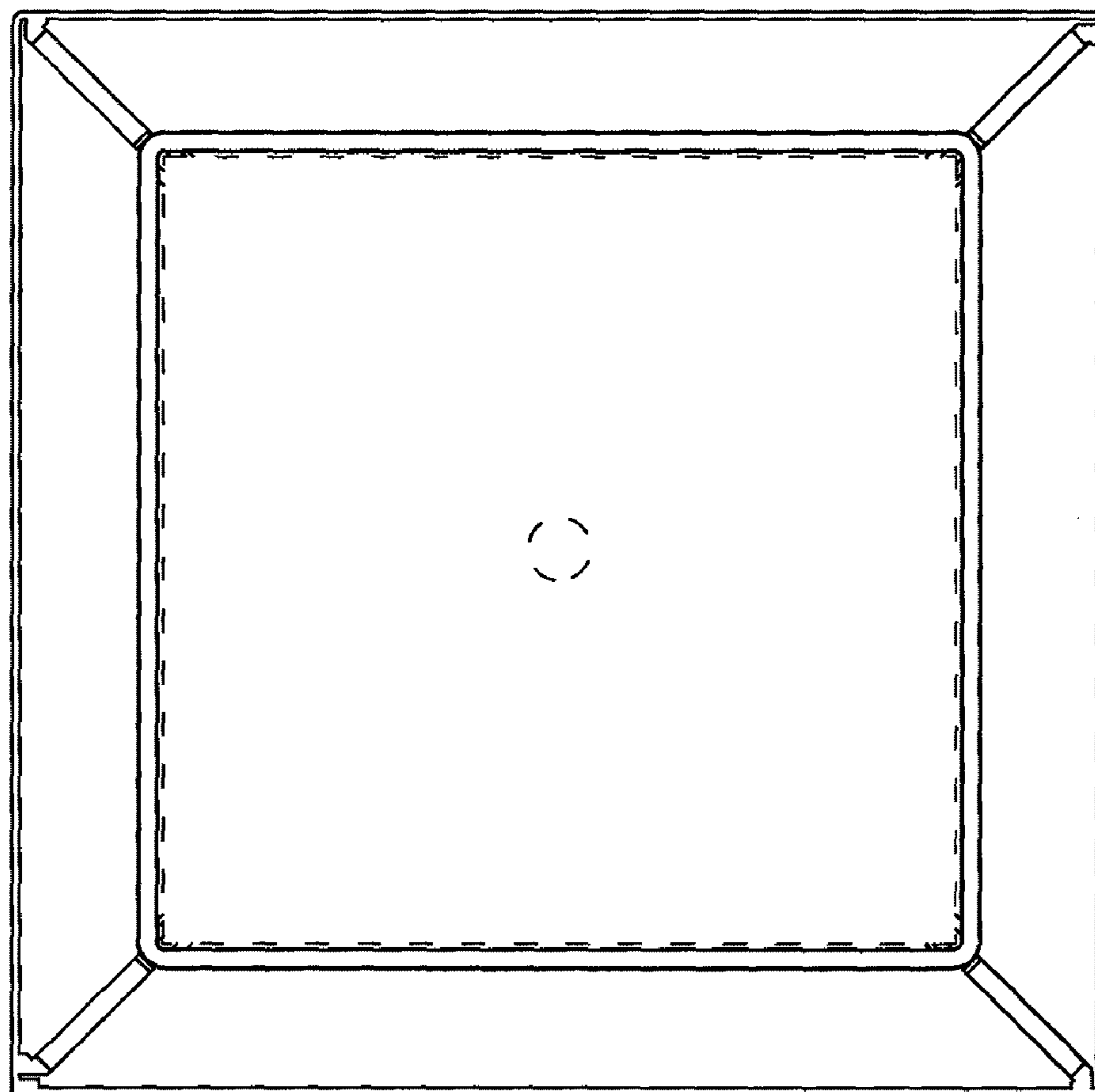

FIG.27

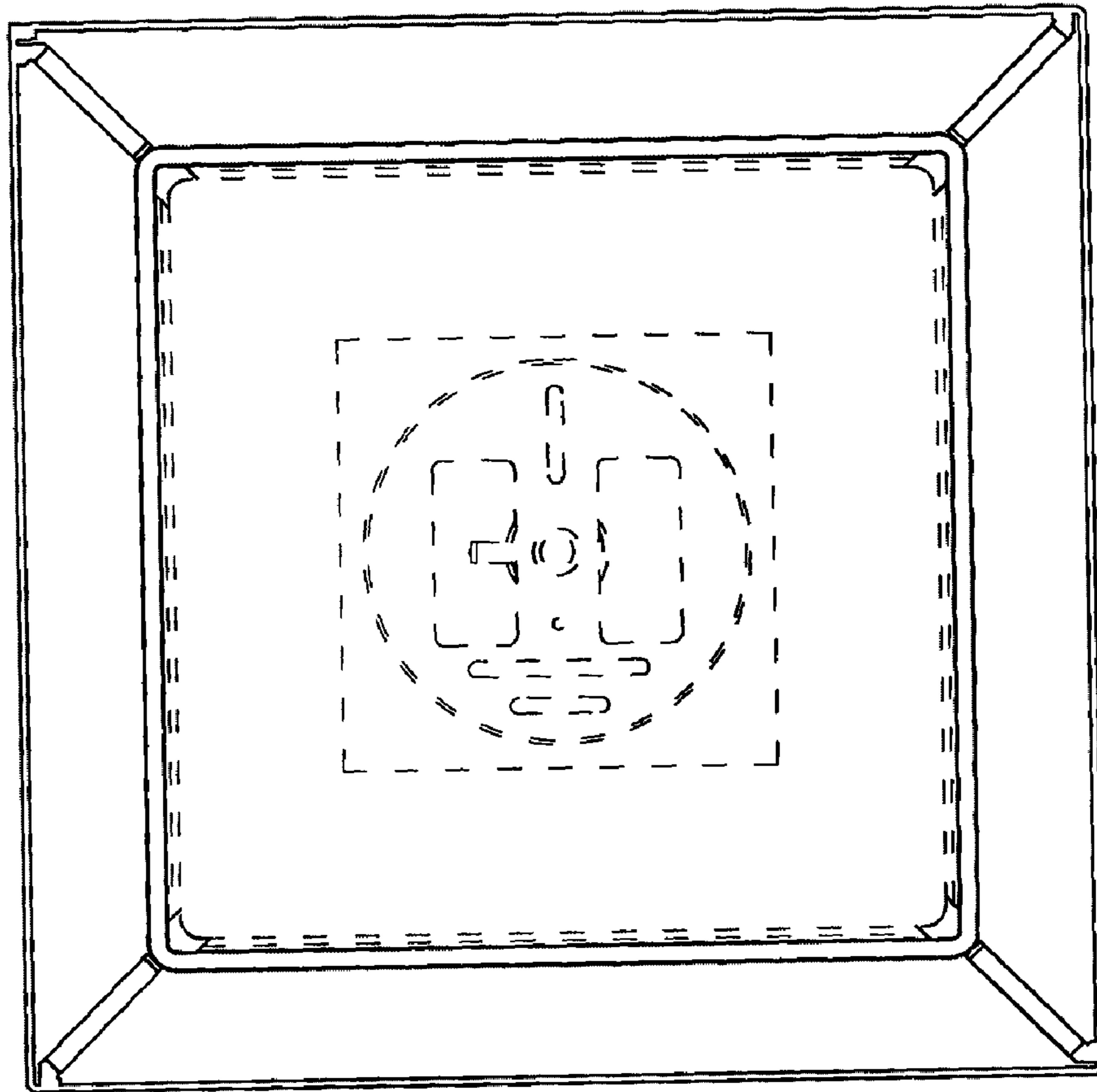

FIG.28

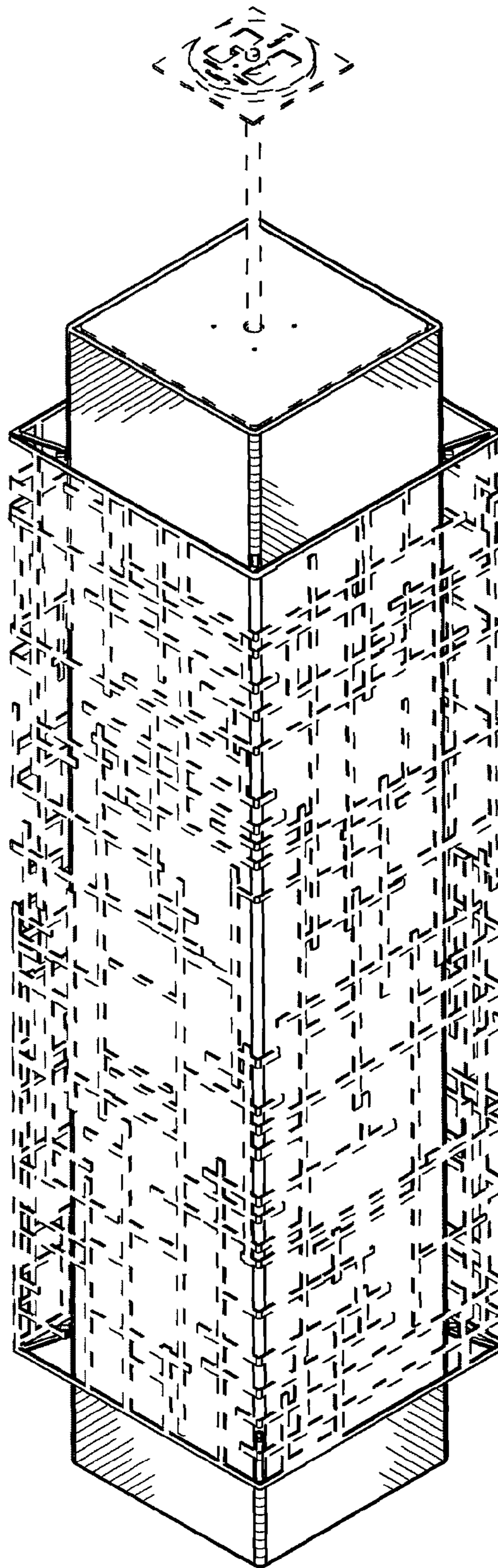

FIG.29

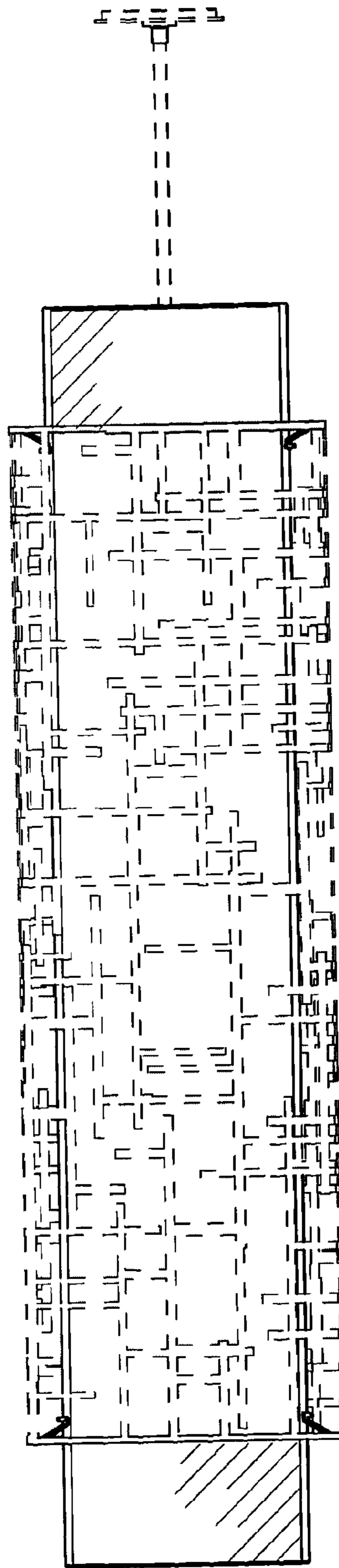

FIG.30



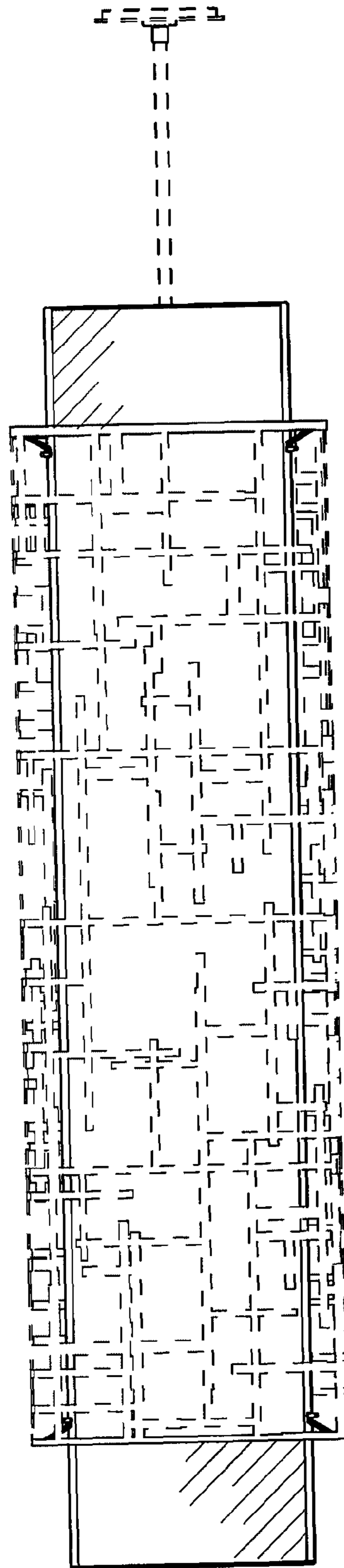

FIG.31

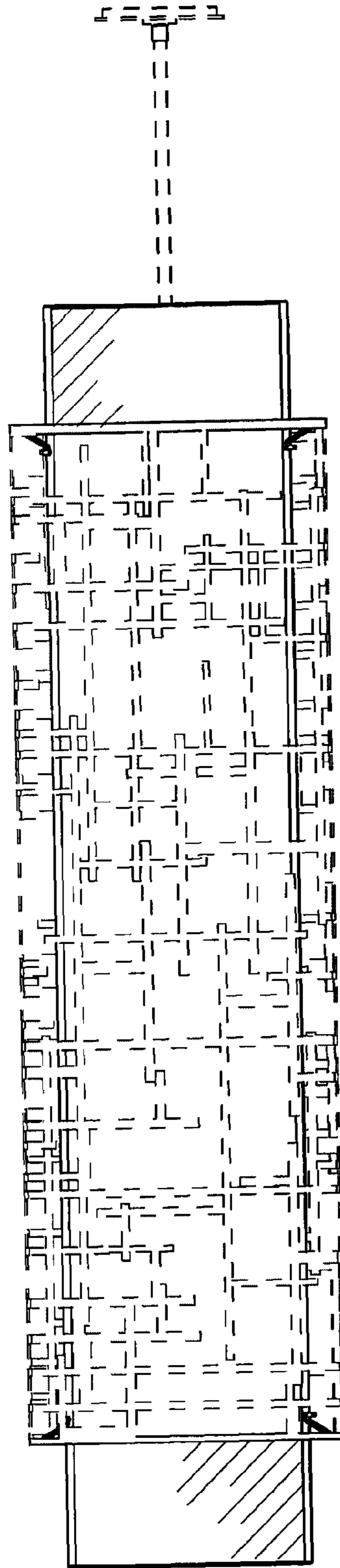

FIG.32

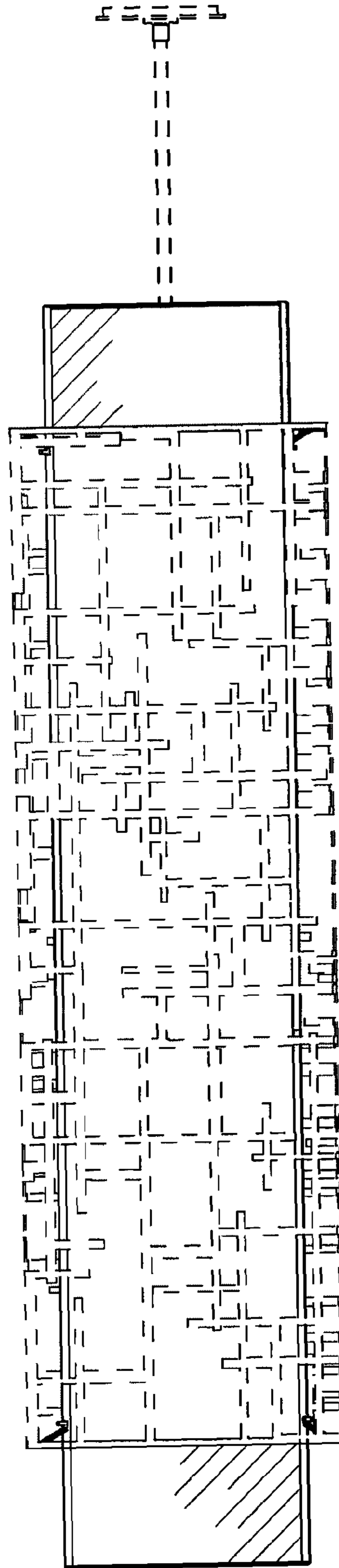
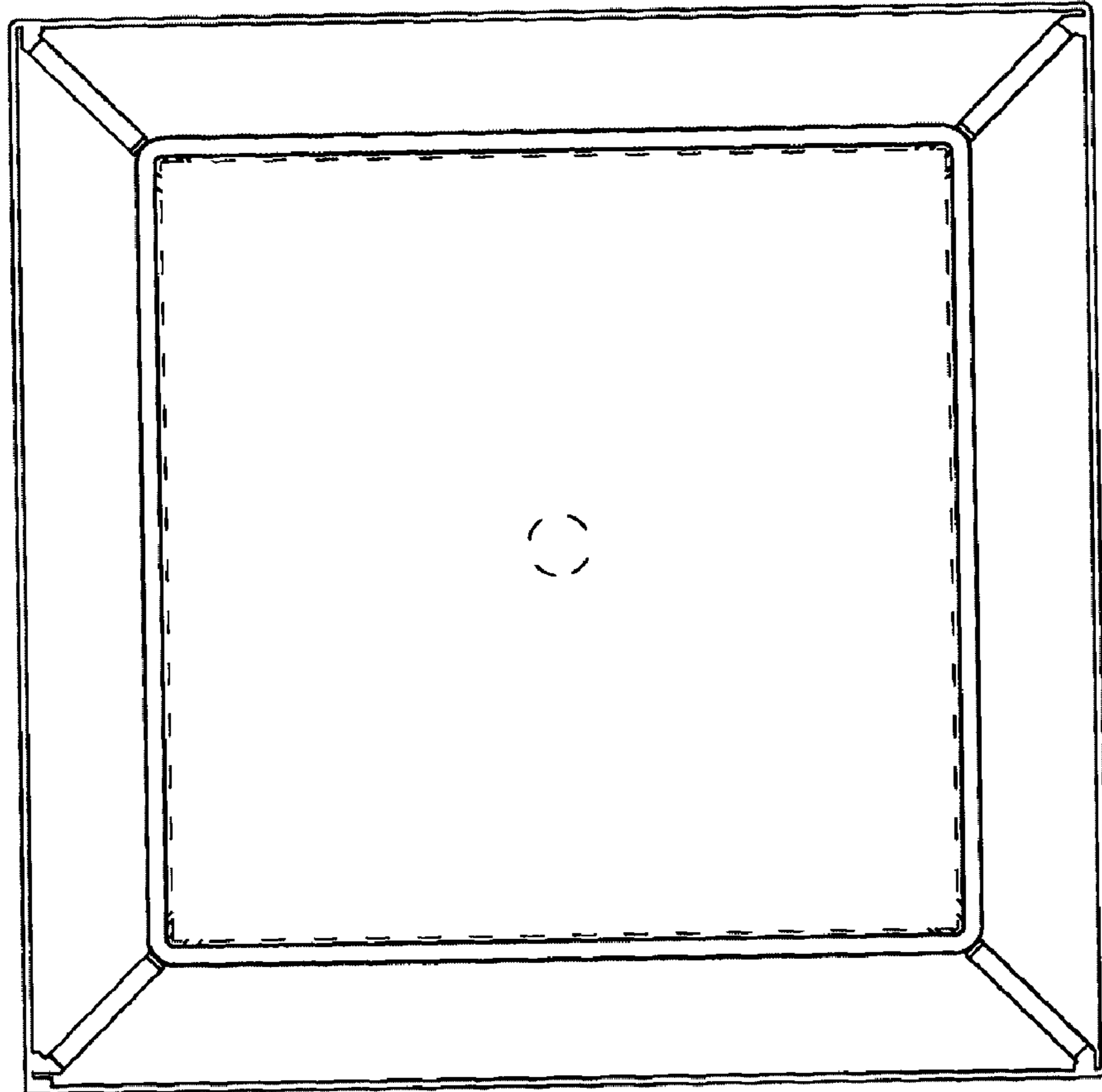

FIG.33



**FIG.34**

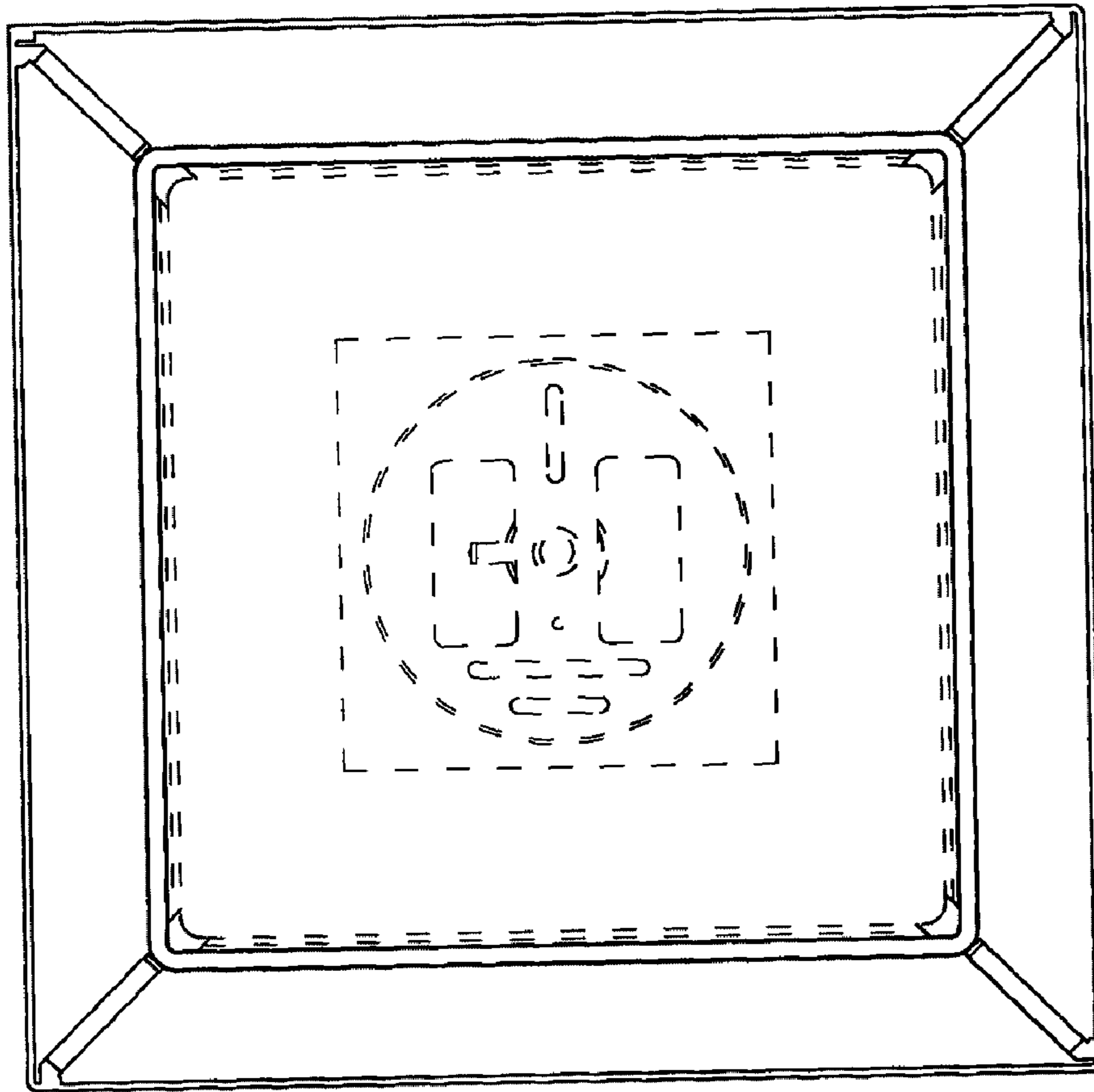

FIG.35

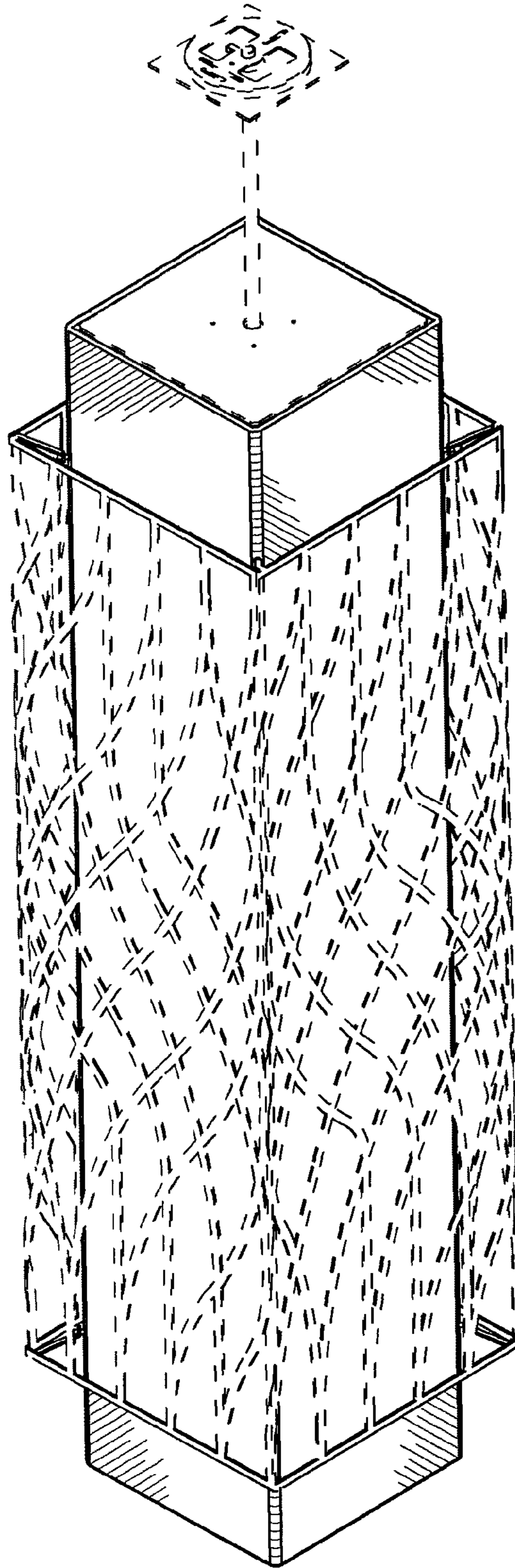

FIG.36

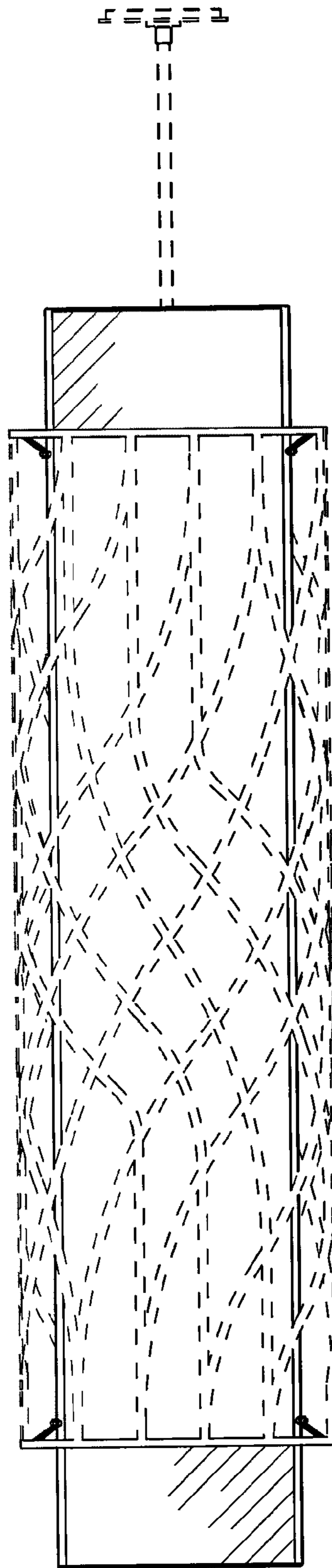

FIG.37

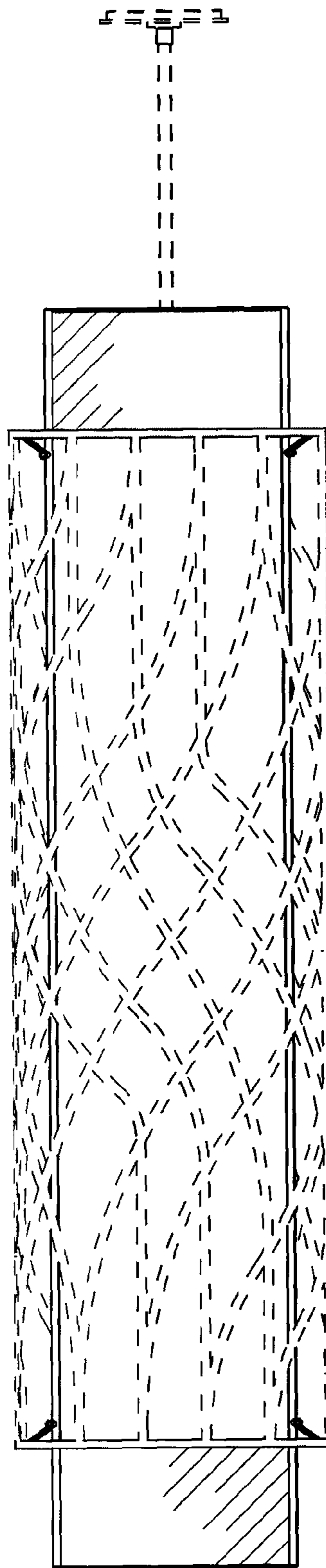

FIG.38



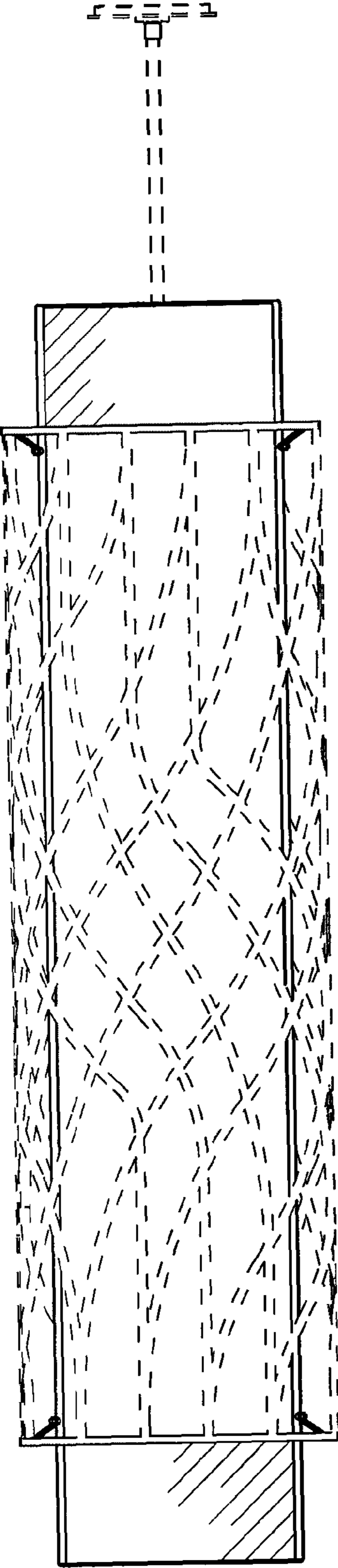

FIG.39

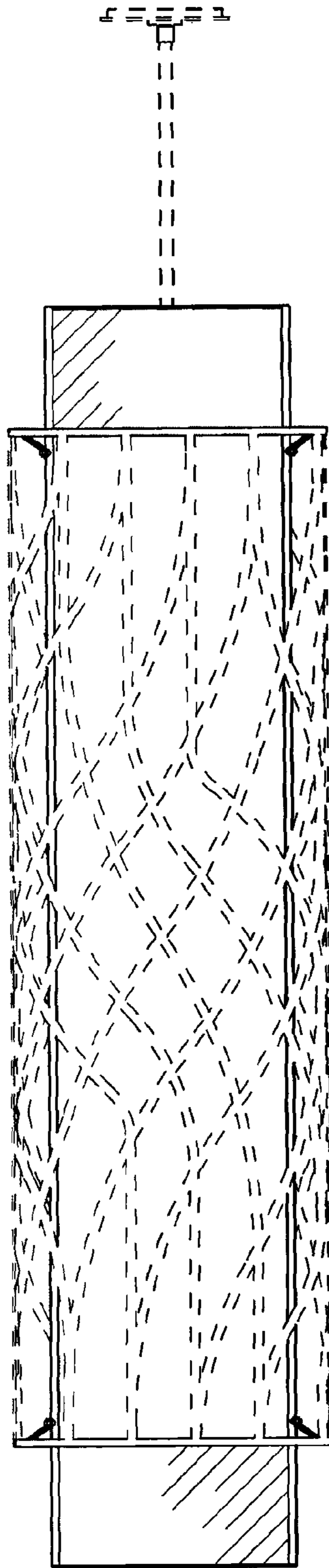

FIG.40

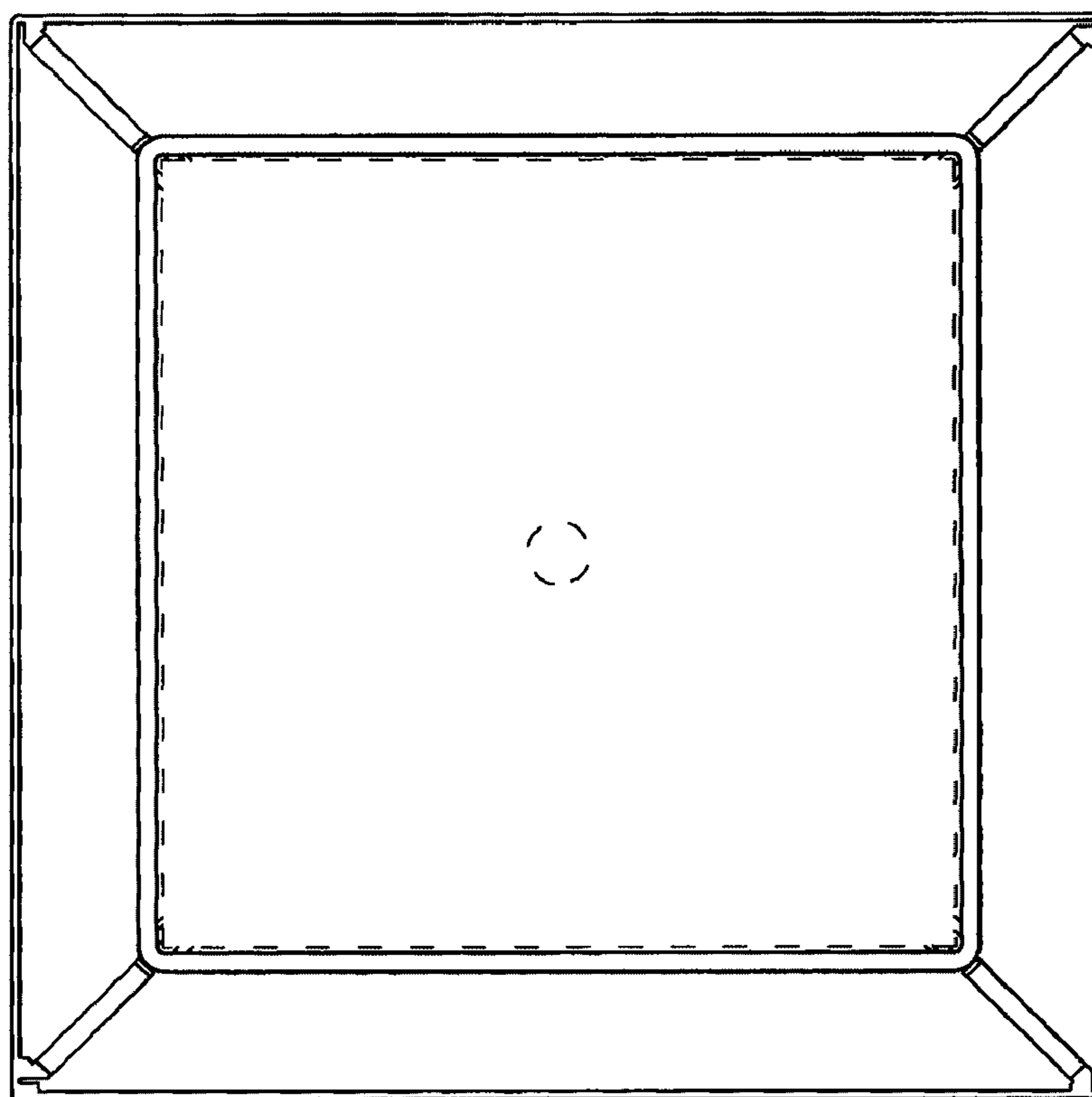

FIG.41

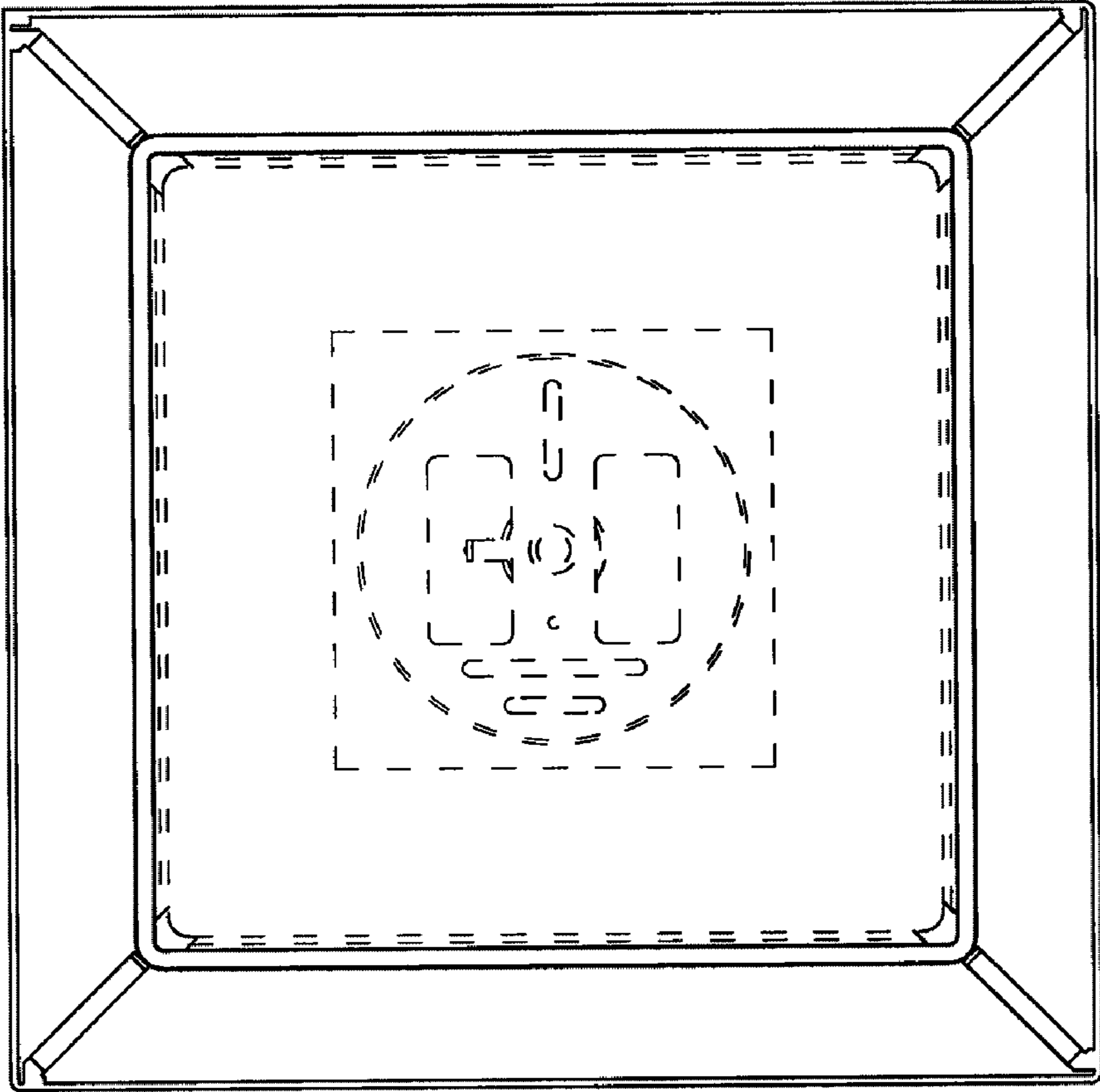

FIG.42