



US00D636514S

(12) **United States Design Patent**
Ruud et al.

(10) **Patent No.:** **US D636,514 S**

(45) **Date of Patent:** **** Apr. 19, 2011**

(54) **LIGHTING FIXTURE**

(75) Inventors: **Alan J. Ruud**, Racine, WI (US); **Brian Kinnune**, Racine, WI (US); **Lisa Ruffalo Cooper**, Franksville, WI (US)

(73) Assignee: **Ruud Lighting, Inc.**, Racine, WI (US)

(**) Term: **14 Years**

(21) Appl. No.: **29/358,365**

(22) Filed: **Mar. 26, 2010**

(51) **LOC (9) Cl.** **26-05**

(52) **U.S. Cl.** **D26/61**

(58) **Field of Classification Search** D26/61,
D26/63-66, 72, 80, 85, 87, 92, 93, 106-109,
D26/102, 113, 118, 122, 134; 362/555, 581,
362/362, 147, 217.01, 220, 217.02, 207.03,
362/217.14-217.17, 269, 270, 277, 278,
362/282-285, 287, 290, 291, 218, 217.1,
362/217.04, 217.05, 279, 280, 323, 419,
362/294, 319, 322, 368, 373, 418, 427, 431,
362/413, 800

See application file for complete search history.

(56) **References Cited**

U.S. PATENT DOCUMENTS

D391,659	S	*	3/1998	Gaskins et al.	D26/71
D566,872	S	*	4/2008	Michel	D26/62
D571,943	S	*	6/2008	Tragatschnig	D26/61
D586,943	S	*	2/2009	Huang	D26/118
D603,077	S	*	10/2009	Kinnune et al.	D26/71
7,637,638	B2	*	12/2009	Chen	362/294
D618,382	S	*	6/2010	Huang	D26/118

D620,165	S	*	7/2010	Huang	D26/63
7,758,207	B1	*	7/2010	Zhou et al.	362/218
D622,889	S	*	8/2010	Zheng	D26/71

* cited by examiner

Primary Examiner — Philip S Hyder

Assistant Examiner — Linda G. Brooks

(74) *Attorney, Agent, or Firm* — Jansson Shupe & Munger Ltd.

(57) **CLAIM**

The ornamental design for a lighting fixture, as shown and described.

DESCRIPTION

FIG. 1 is a perspective view from above of the lighting fixture; FIG. 2 is a perspective view from below of the lighting fixture of FIG. 1, the details of the underside of the fixture being shown in broken lines;

FIG. 3 is a right-side elevation of the lighting fixture of FIG. 1, the left-side elevation view being a mirror image thereof; FIG. 4 is a bottom plan view of the lighting fixture of FIG. 1, the details of the underside of the fixture being shown in broken lines;

FIG. 5 is a top plan view of the lighting fixture of FIG. 1; FIG. 6 is a front elevation of the lighting fixture of FIG. 1; FIG. 7 is a rear elevation of the lighting fixture of FIG. 1; FIG. 8 is a perspective view from above of a second embodiment of the design of FIG. 1, the only difference being in shorter proportional size of the finned portion; and, FIG. 9 is a perspective view from above of a third embodiment of the design of FIG. 1, the only difference being in longer proportional size of the finned portion.

The broken lines illustrate unclaimed portions of the lighting fixture and environmental structure that forms no part of the claimed design.

1 Claim, 6 Drawing Sheets

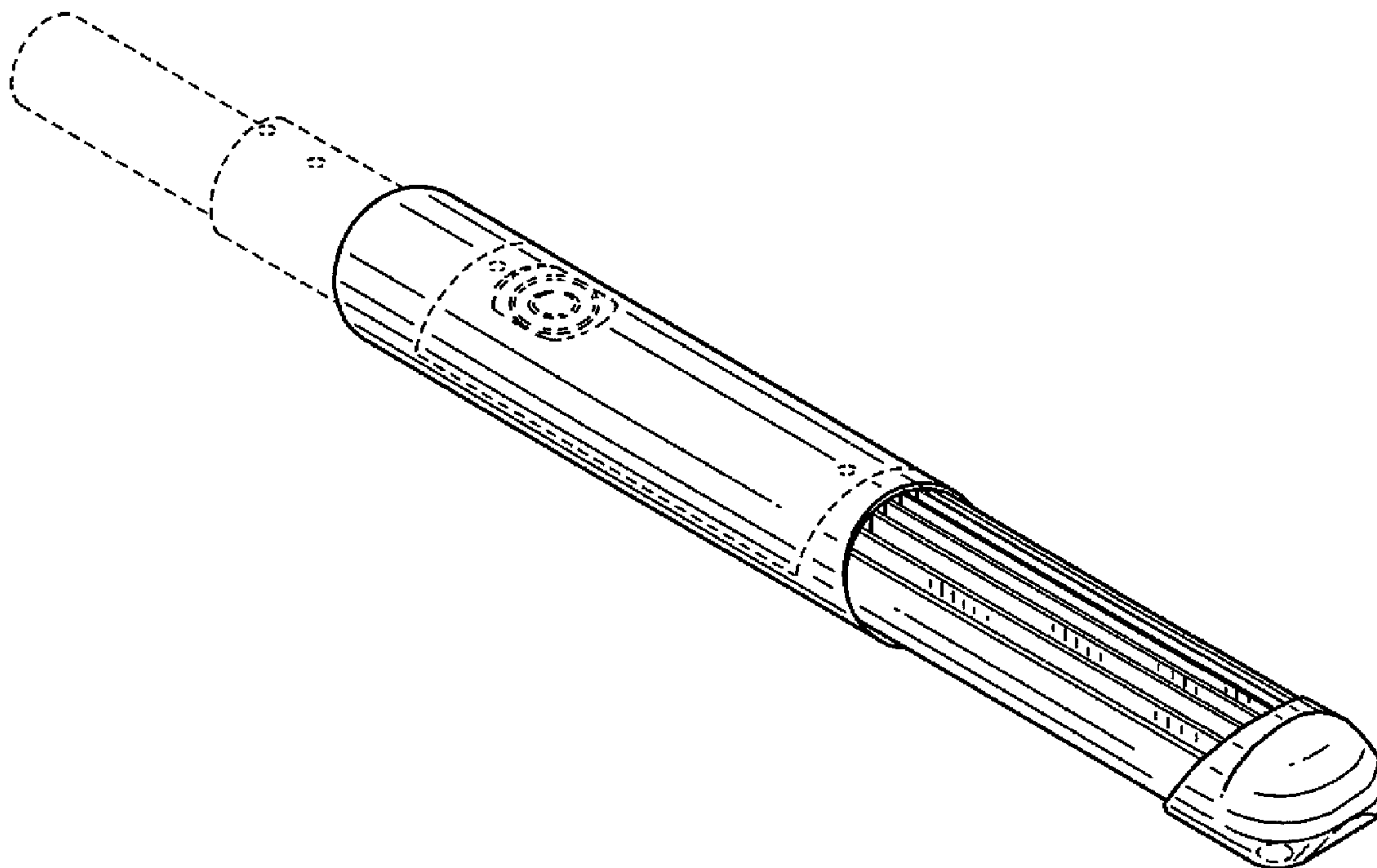

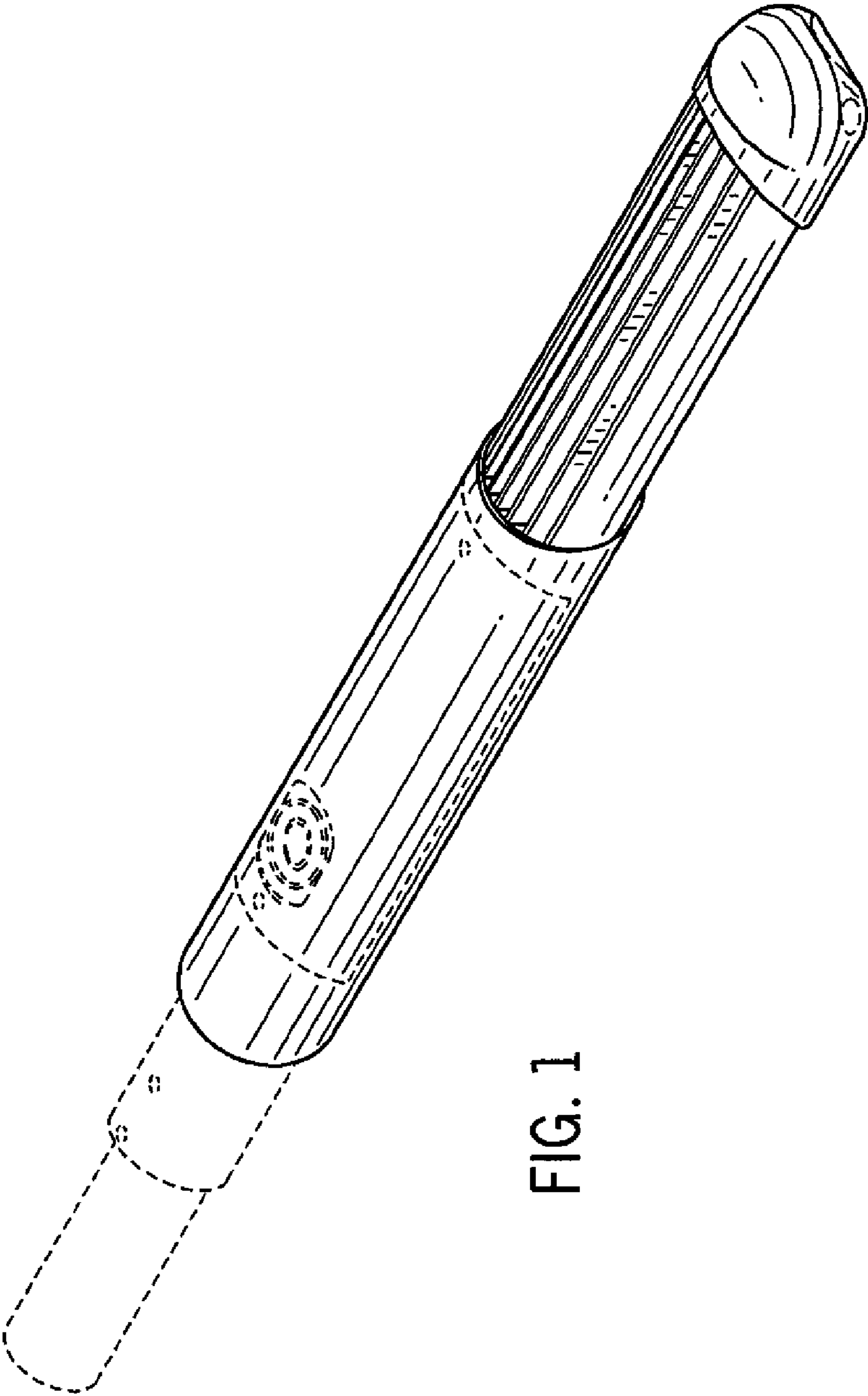

FIG. 1

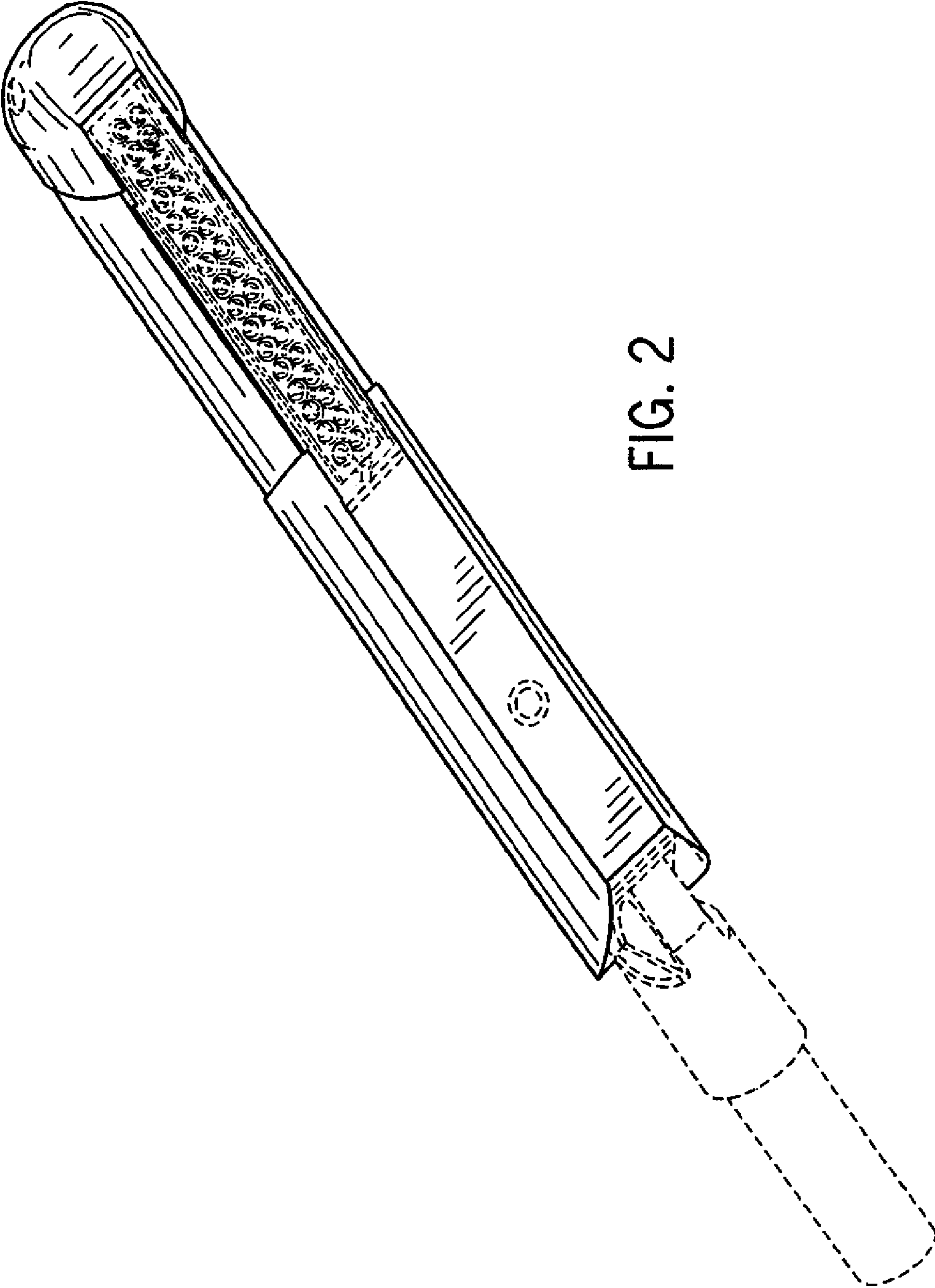

FIG. 2

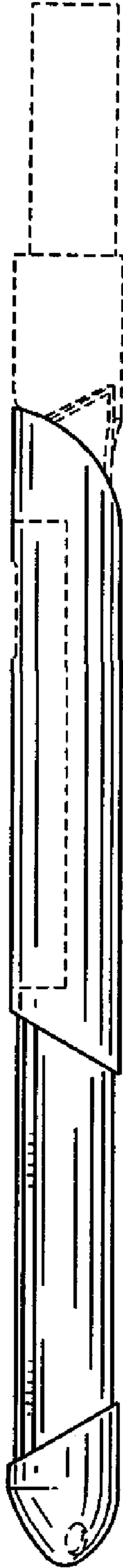

FIG. 3

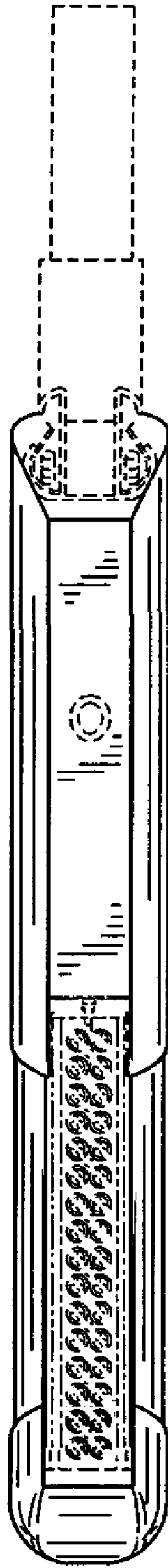

FIG. 4

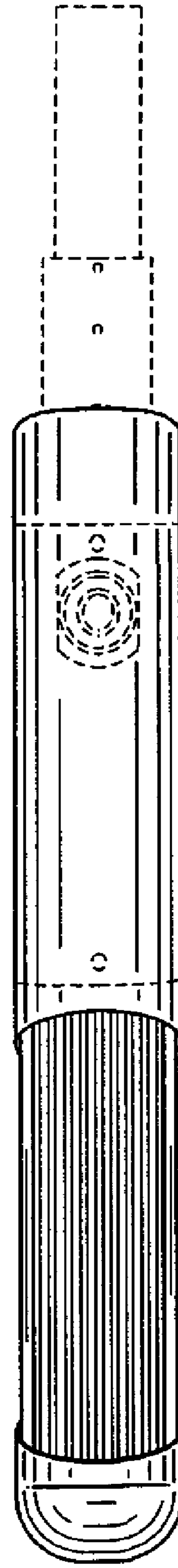

FIG. 5

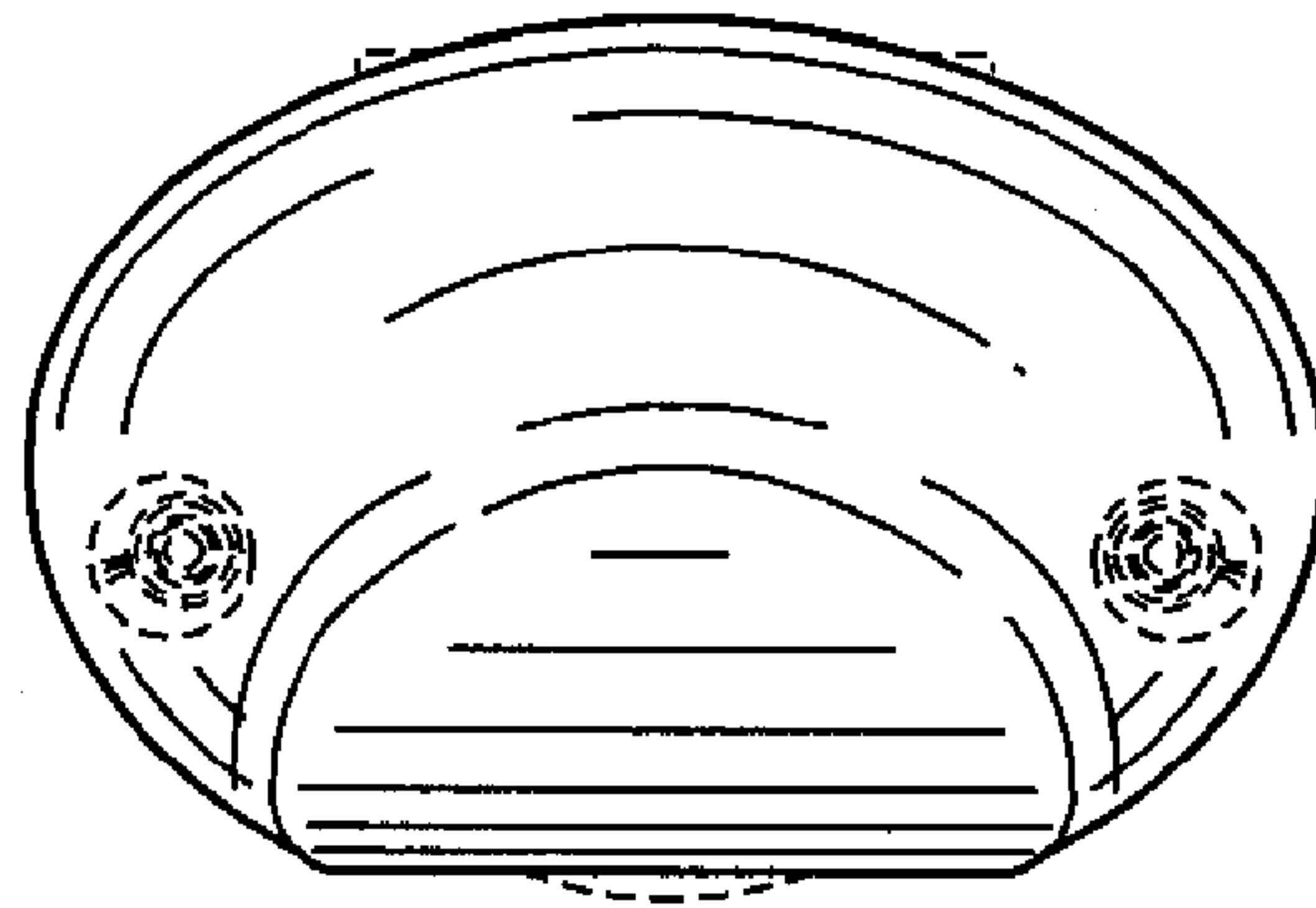

FIG. 6

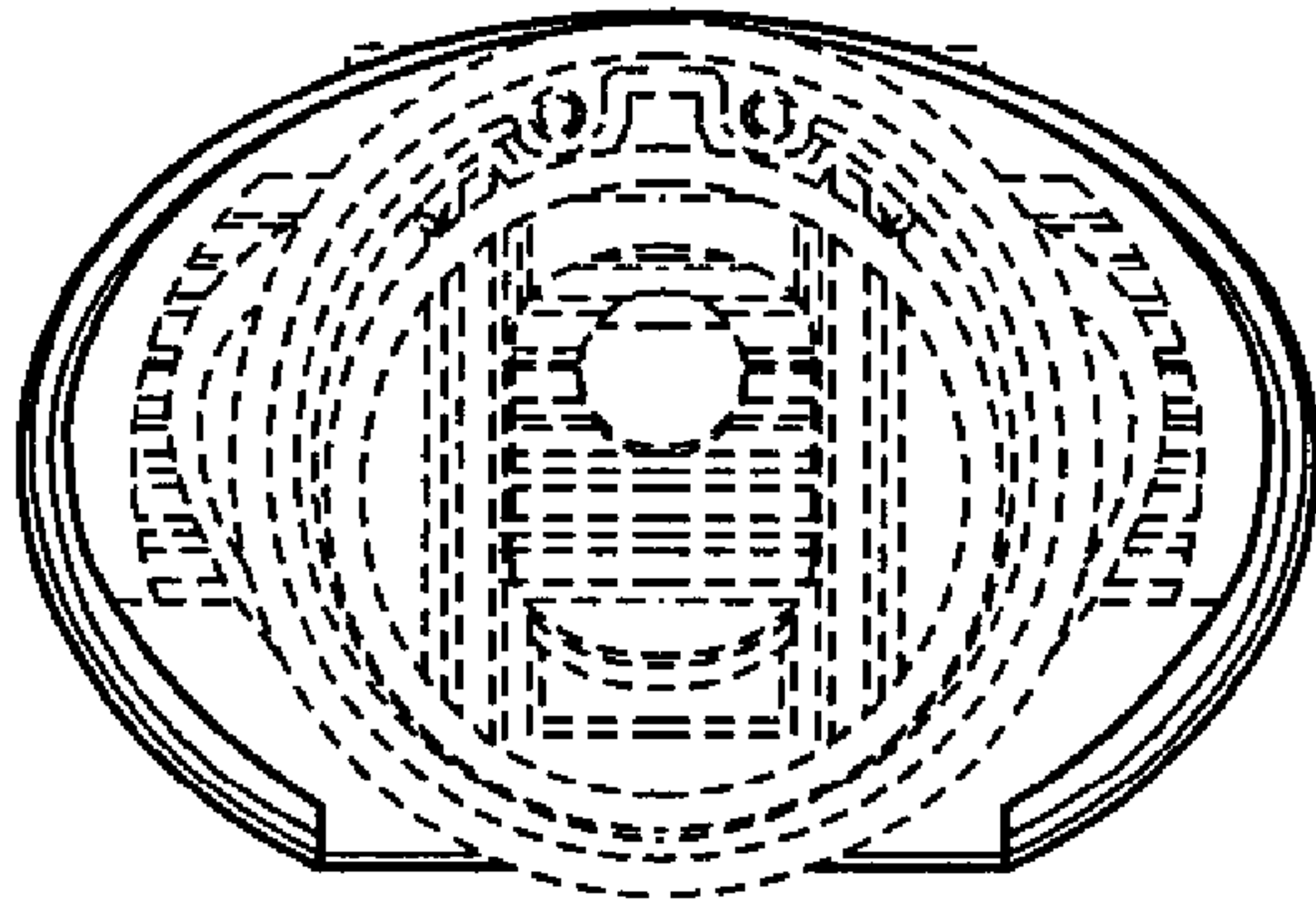

FIG. 7

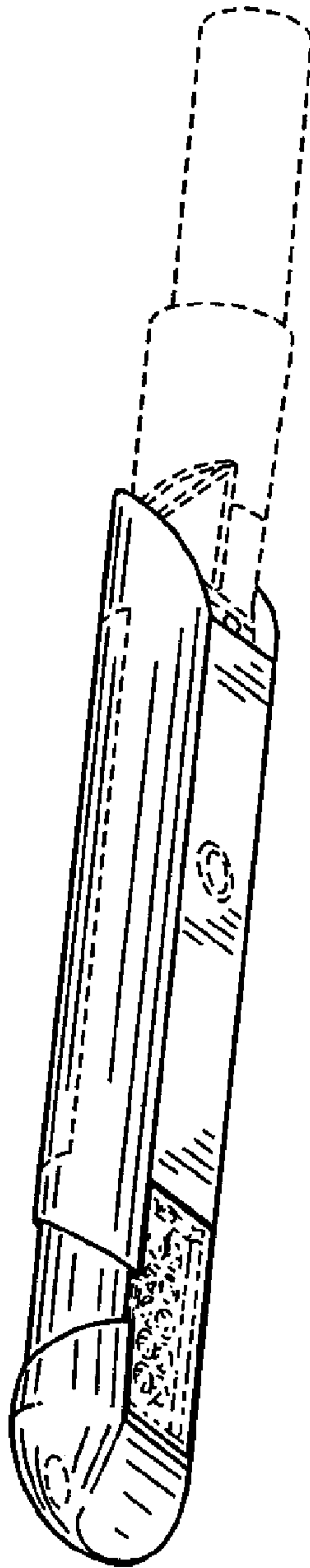

FIG. 8

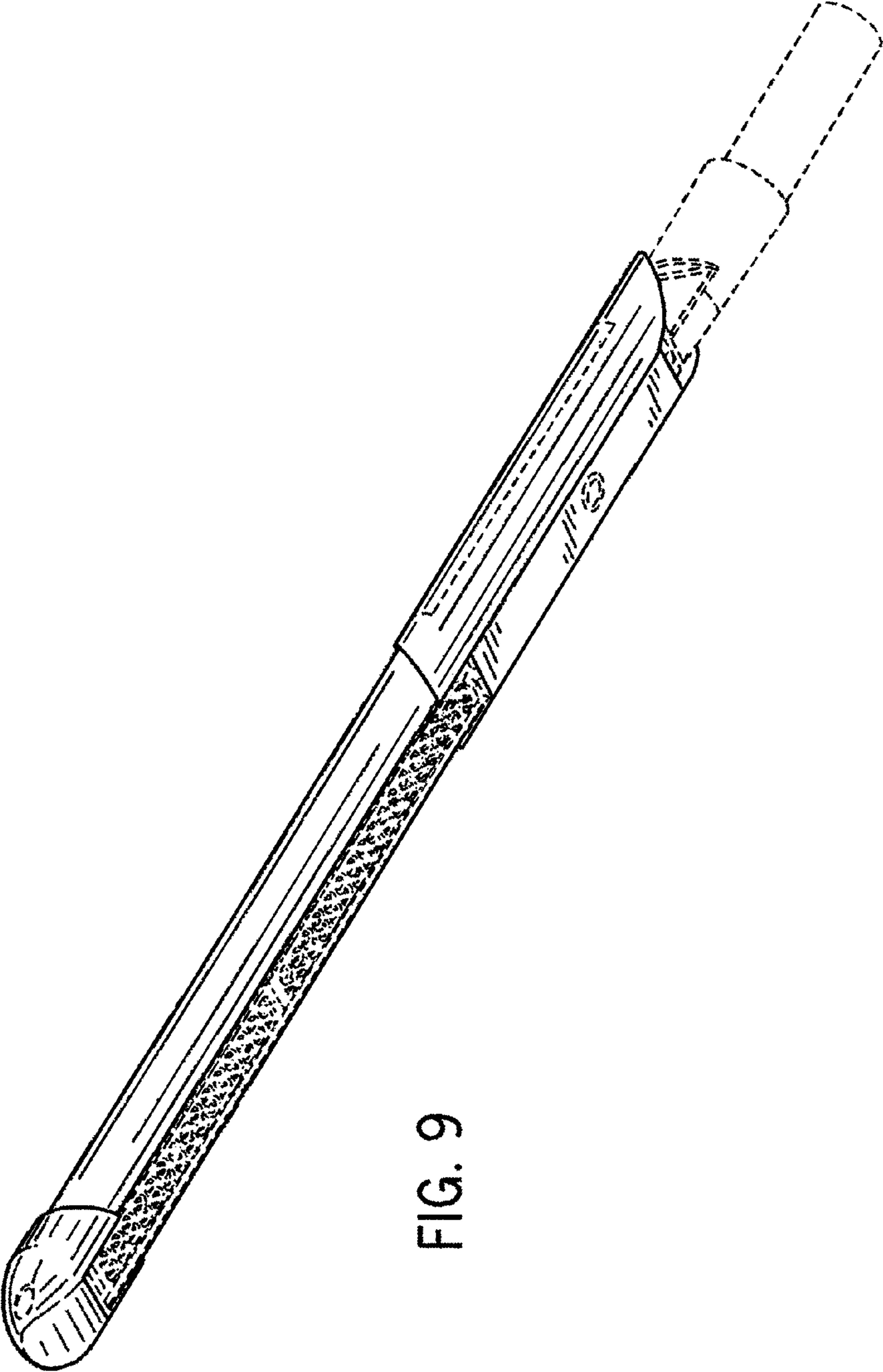

FIG. 9