



US00D636370S

(12) **United States Design Patent**
Huang

(10) **Patent No.:** **US D636,370 S**
(45) **Date of Patent:** **** Apr. 19, 2011**

- (54) **HANDSET**
- (75) Inventor: **QiaoKun Huang**, Guangzhou (CN)
- (73) Assignee: **Nokia Corporation**, Espoo (FI)
- (**) Term: **14 Years**
- (21) Appl. No.: **29/380,089**
- (22) Filed: **Nov. 30, 2010**

- D601,540 S 10/2009 Kim et al.
- D603,406 S 11/2009 Wood et al.
- D606,540 S 12/2009 Liao et al.
- D607,866 S 1/2010 Kim et al.
- D607,868 S 1/2010 Kim et al.
- D612,376 S 3/2010 Cebe
- D613,723 S 4/2010 Tang et al.
- D614,159 S 4/2010 Lee et al.
- D615,058 S 5/2010 Lee et al.
- D615,061 S 5/2010 Choi et al.
- D615,524 S 5/2010 He

(Continued)

Related U.S. Application Data

- (63) Continuation of application No. 29/364,618, filed on Jun. 25, 2010, now Pat. No. Des. 628,187.
- (51) **LOC (9) Cl.** **14-03**
- (52) **U.S. Cl.** **D14/138 AA**
- (58) **Field of Classification Search** D14/138 AA, D14/138 R, 147, 341, 346, 137, 496, 218, D14/148, 248, 137 AD, 203.3, 203.4, 203.7, D14/345; 455/575.1, 556.2, 575.3, 575.4; 379/433.01, 433.04; D21/517; D13/168
See application file for complete search history.

OTHER PUBLICATIONS

Nokia X2-01 telephone, announced Nov. 2010, [online], [site visited Feb. 16, 2011]. Available from Internet ,<URL: <http://www.gsmarena.com>>.*

(Continued)

Primary Examiner — Jeffrey D Asch
(74) *Attorney, Agent, or Firm* — Banner & Witcoff, Ltd.

(57) **CLAIM**
The ornamental design for a handset, as shown and described.

DESCRIPTION

FIG. 1 is a perspective front view of a handset showing my new design;
FIG. 2 is a front view thereof;
FIG. 3 is a rear view thereof;
FIG. 4 is a left side view thereof;
FIG. 5 is a right side thereof;
FIG. 6 is a top view thereof; and,
FIG. 7 is a bottom view thereof.
The broken lines shown throughout the views that are immediately adjacent to the shaded areas, and define unshaded regions, represent the bounds of the claimed design, while all other broken lines are directed to environment and are for illustrative purposes only; the broken lines form no part of the claimed design.

(56) **References Cited**

U.S. PATENT DOCUMENTS

- D548,218 S 8/2007 Hong et al.
- D551,227 S 9/2007 Griffin et al.
- D559,223 S 1/2008 Kim et al.
- D563,378 S 3/2008 Tseng et al.
- D565,599 S * 4/2008 Jang et al. D14/496
- D566,086 S 4/2008 Hong et al.
- D566,094 S 4/2008 Kim et al.
- D573,570 S * 7/2008 Park et al. D14/138 AA
- D573,969 S 7/2008 Tu
- D582,374 S * 12/2008 Hu et al. D14/138 AA
- D584,262 S 1/2009 Hu et al.
- D591,742 S 5/2009 Hofer et al.
- D598,885 S 8/2009 Kangasmaa et al.
- D599,316 S 9/2009 Hong et al.
- D599,794 S 9/2009 Ferrari et al.
- D600,229 S 9/2009 Kangasmaa
- D601,529 S 10/2009 Rouger

1 Claim, 5 Drawing Sheets

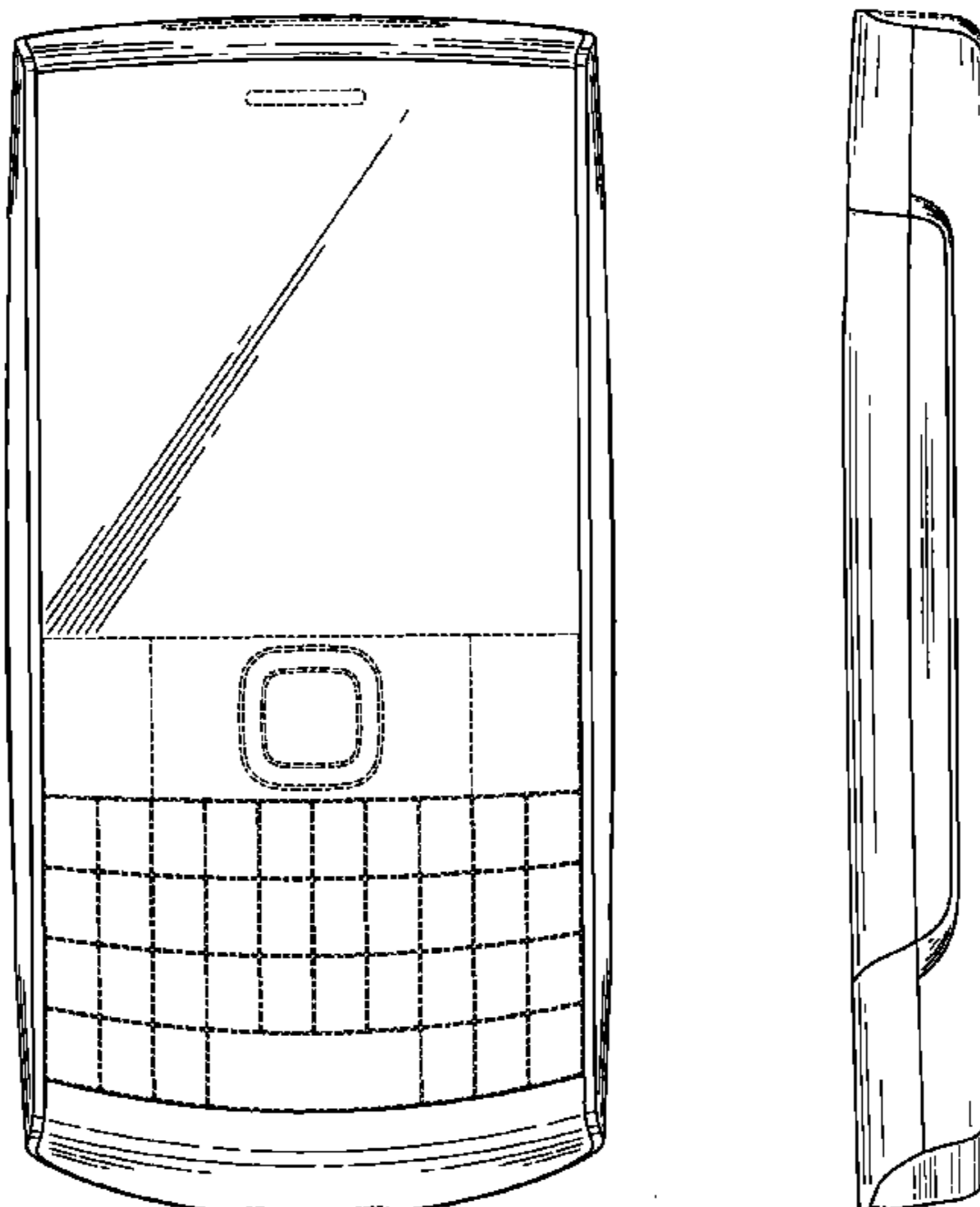

U.S. PATENT DOCUMENTS

D618,656	S	6/2010	Hunt	
D620,468	S	7/2010	Kim et al.	
D623,163	S	9/2010	Choi et al.	
D624,075	S *	9/2010	Corley et al.	D14/346
D624,538	S *	9/2010	Corley et al.	D14/346
D628,182	S *	11/2010	Hirano	D14/138 AA
D628,187	S *	11/2010	Huang	D14/138 AA
D630,608	S *	1/2011	Choi et al.	D14/138 AA
D630,610	S *	1/2011	Li	D14/138 AA
D632,662	S *	2/2011	Ng	D14/138 AA
2009/0203398	A1	8/2009	Griffin	
2010/0273542	A1 *	10/2010	Holman et al.	455/575.4

OTHER PUBLICATIONS

Sony Ericsson Aspen telephone, announced Feb. 2010, [online], [site visited Feb. 16, 2011]. Available from Internet, <URL: <http://www.gsmarena.com>>.*

Acer beTouch E210 telephone, announced Jan. 2011, [online], [site visited Feb. 16, 2011]. Available from Internet, <URL: <http://www.gsmarena.com>>.*

Nokia 6708, Nokia Corporation, 1 color sheet of photographs, disclosed on or about Q1 2005.

Nokia E55, Nokia Corporation, 1 color sheet of photographs, disclosed on or about Feb. 2009.

Nokia E61, Nokia Corporation, 1 color sheet of photographs, disclosed on or about Oct. 2005.

Nokia E63, Nokia Corporation, 1 color sheet of photographs, disclosed on or about Nov. 2008.

Nokia E71, Nokia Corporation, 1 color sheet of photographs, disclosed on or about Jun. 2008.

Nokia C3-01 Touch and Type telephone, announced Sep. 2010, [online], [site visited Sep. 22, 2010]. Available from Internet, <URL: <http://www.gsmarena.com>>.

Nokia C5 TD-SCMA telephone, announced Apr. 2010, [online], [site visited Sep. 22, 2010]. Available from Internet, <URL: <http://www.gsmarena.com>>.

Nokia E71 telephone, announced Jun. 2008, [online], [site visited Sep. 22, 2010]. Available from Internet, <URL: <http://www.gsmarena.com>>.

Nokia E73 Mode telephone, announced Jun. 2010, [online], [site visited Sep. 22, 2010]. Available from Internet, <URL: <http://www.gsmarena.com>>.

Samsung i780 telephone, announced Sep. 2007, [online], [site visited Sep. 22, 2010]. Available from Internet, <URL: <http://www.gsmarena.com>>.

Samsung SPH-i325 Ace telephone, announced Dec. 2007, [online], [site visited Sep. 22, 2010]. Available from Internet, <URL: <http://www.gsmarena.com>>.

Motorola Q11 telephone, announced Oct. 2008, [online], [site visited Sep. 22, 2010]. Available from Internet, <URL: <http://www.gsmarena.com>>.

HP iPAQ Glisten telephone, announced Nov. 2009, [online], [site visited Sep. 22, 2010]. Available from Internet, <URL: <http://www.gsmarena.com>>.

Acer beTouch E130 telephone, announced Jun. 2010, [online], [site visited Sep. 22, 2010]. Available from Internet, <URL: <http://www.gsmarena.com>>.

Vodaphone 546 telephone, announced Apr. 2010, [online], [site visited Sep. 22, 2010]. Available from Internet, <URL: <http://www.gsmarena.com>>.

* cited by examiner

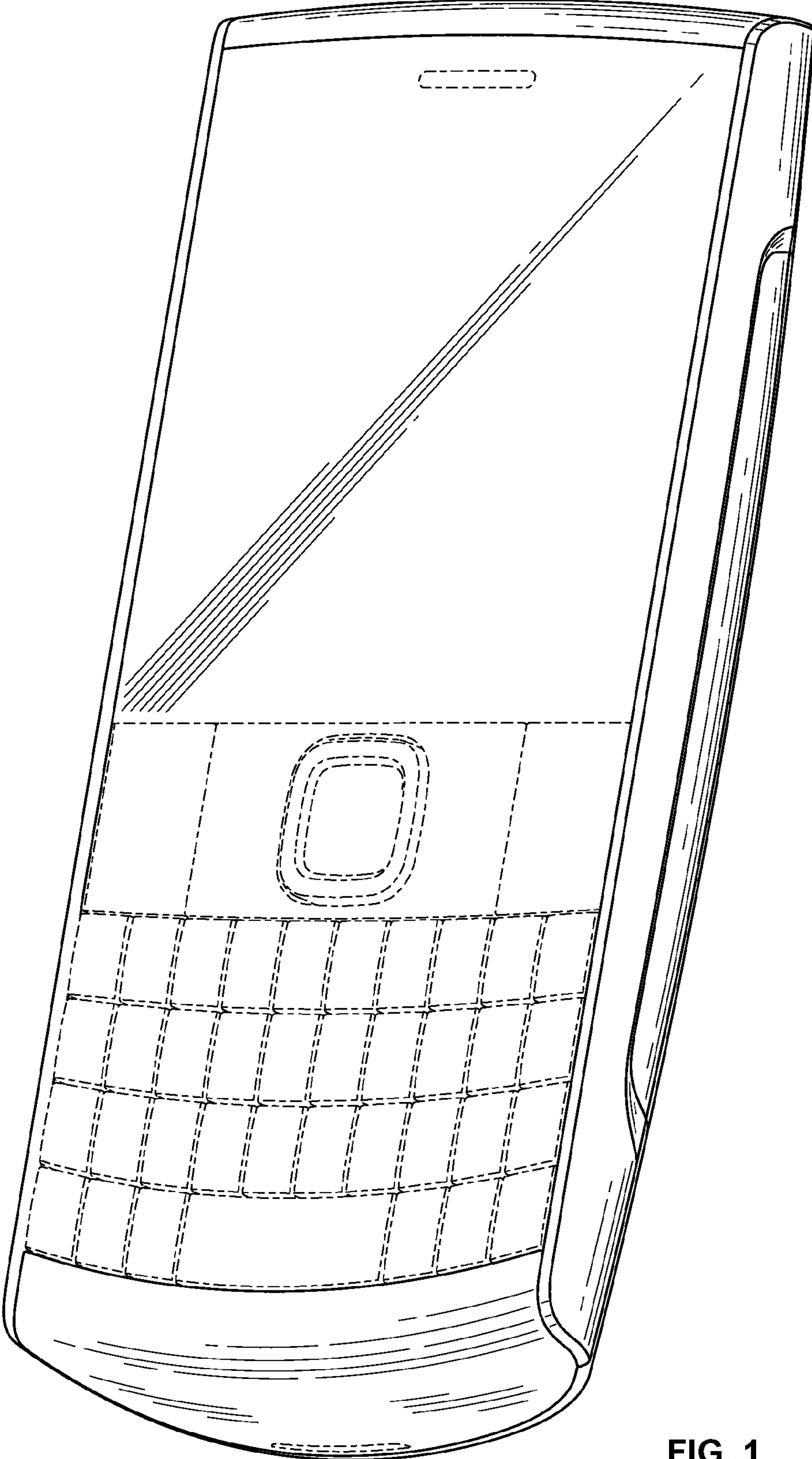

FIG. 1

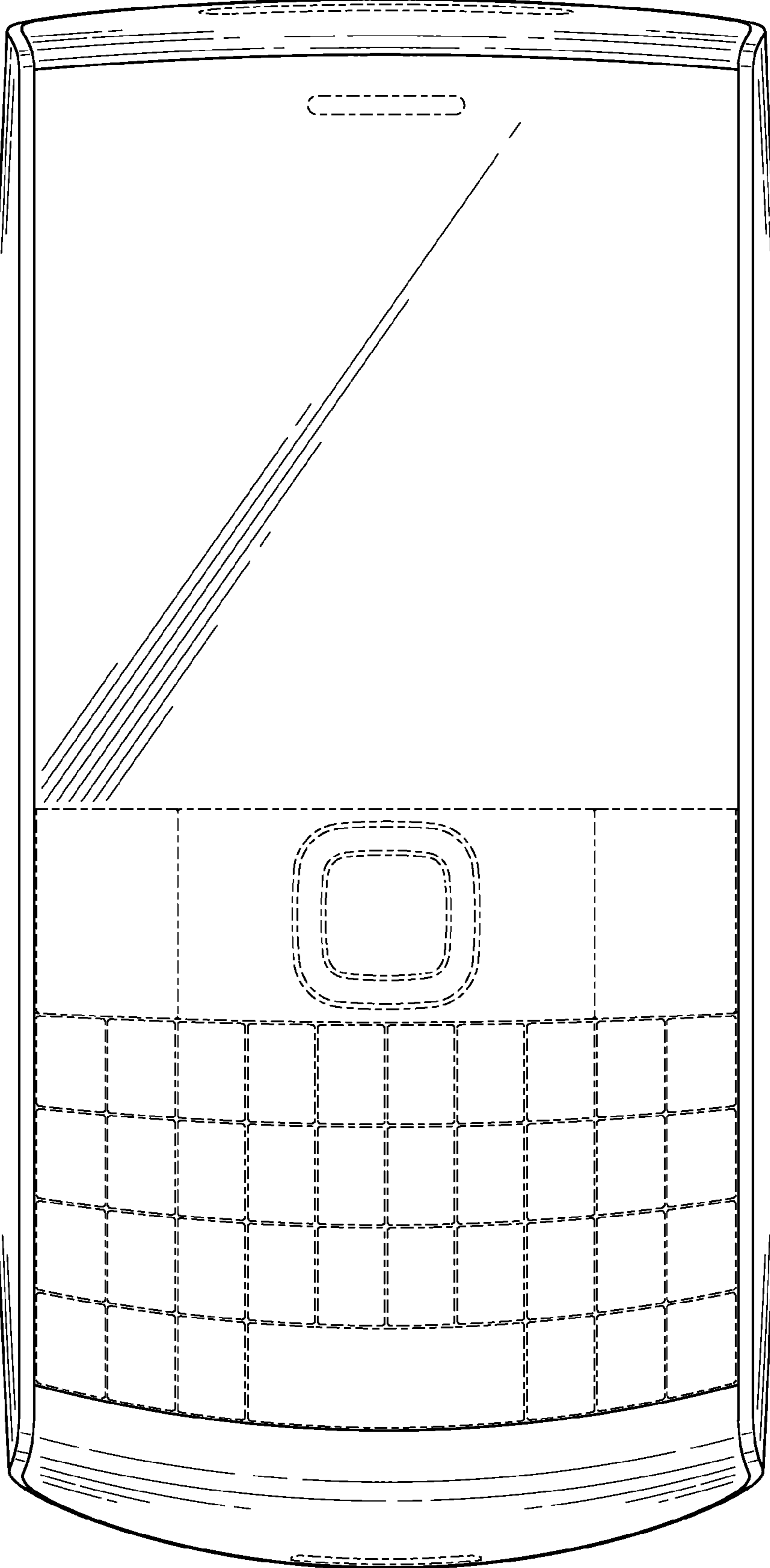

FIG. 2

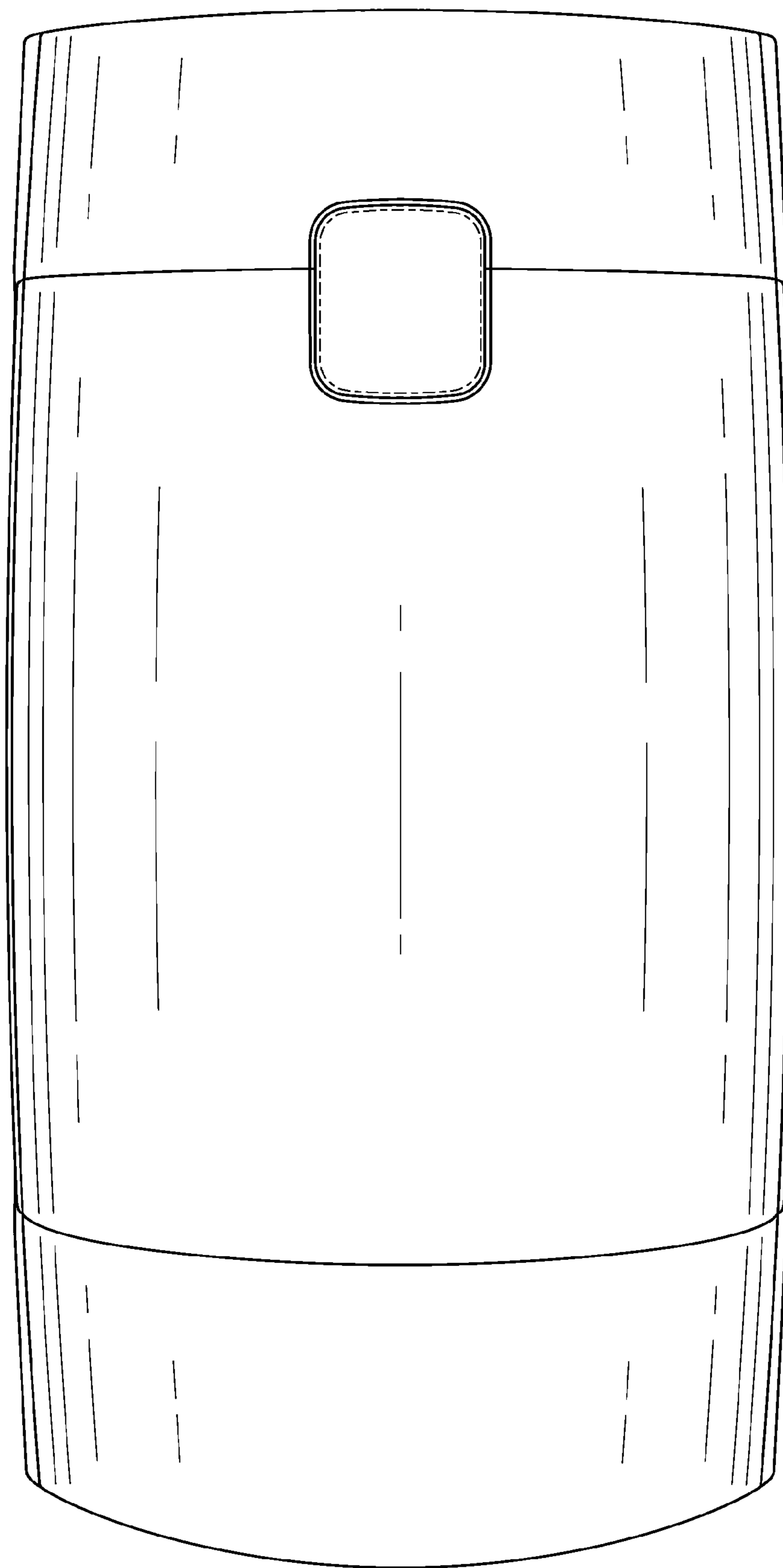

FIG. 3



FIG. 4

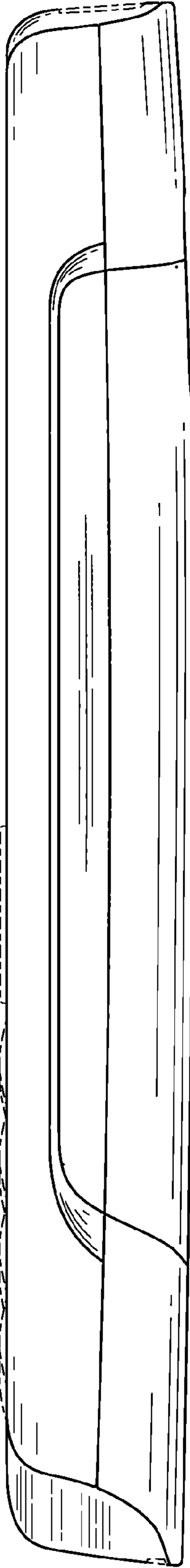

FIG. 5

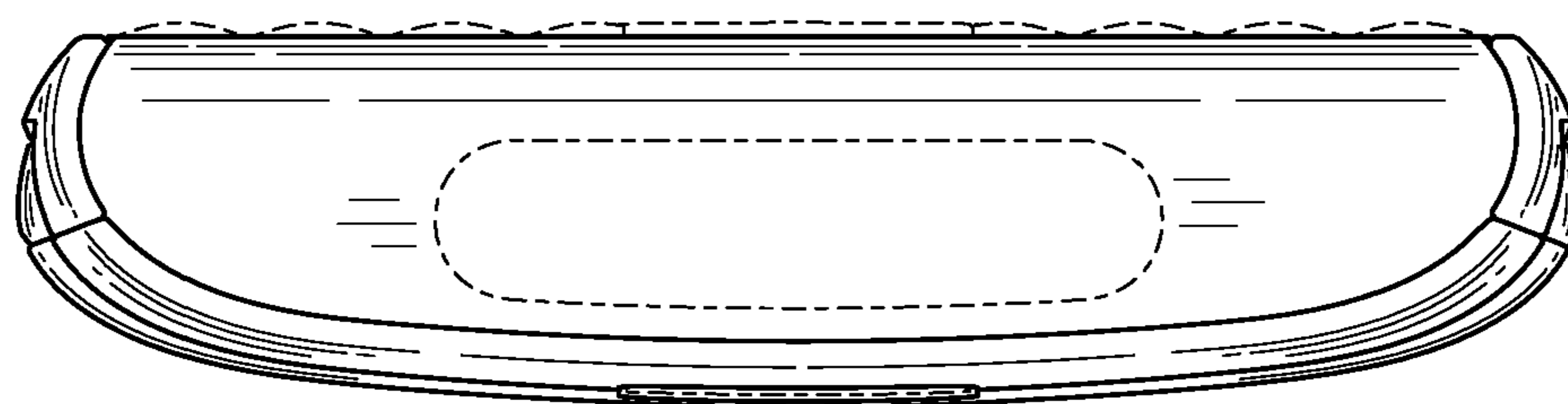

FIG. 6

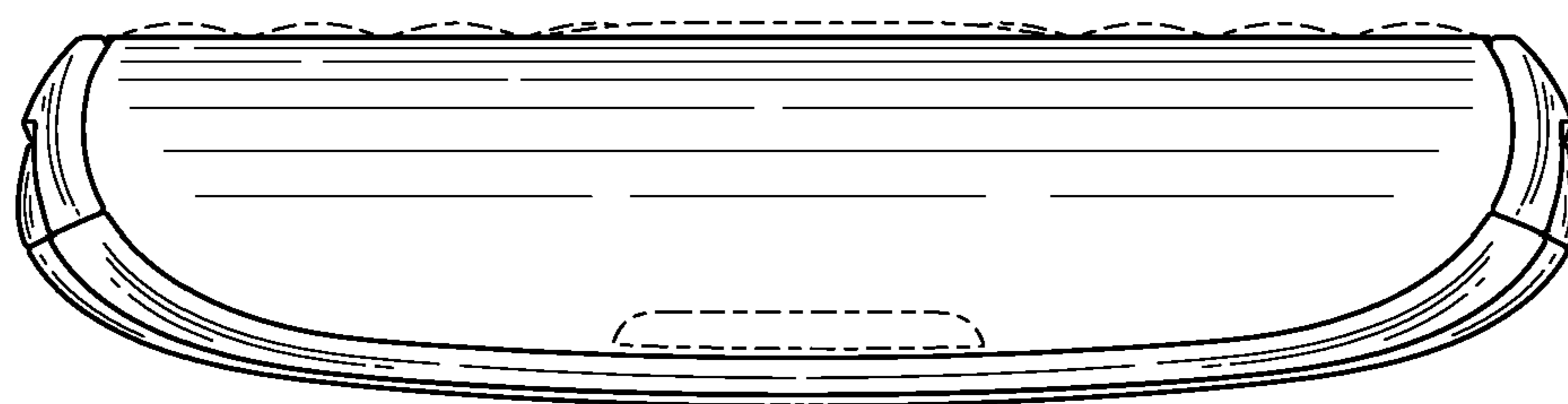

FIG. 7