



US00D636363S

(12) **United States Design Patent**
Stillerman et al.

(10) **Patent No.:** **US D636,363 S**

(45) **Date of Patent:** **** *Apr. 19, 2011**

(54) **HANDSET**

(75) Inventors: **Jan Stillerman**, Thousand Oaks, CA
(US); **Wei-Jones He**, Beijing (CN)

(73) Assignee: **Nokia Corporation**, Espoo (FI)

(*) Notice: This patent is subject to a terminal disclaimer.

(**) Term: **14 Years**

(21) Appl. No.: **29/351,319**

(22) Filed: **Dec. 3, 2009**

(51) **LOC (9) Cl.** **14-03**

(52) **U.S. Cl.** **D14/138 AA**

(58) **Field of Classification Search** D14/138 AA,
D14/496, 341, 345, 346, 203.3, 203.4, 203.7,
D14/138 AD, 138 AB, 138 R, 147; 455/575.1,
455/556.2; D21/517; 379/433.01, 433.04
See application file for complete search history.

(56) **References Cited**

U.S. PATENT DOCUMENTS

D548,218	S	*	8/2007	Hong et al.	D14/138 AA
D554,634	S	*	11/2007	Huang	D14/341
D556,726	S	*	12/2007	Dai	D14/138 AA
D563,378	S	*	3/2008	Tseng et al.	D14/138 AA
D566,094	S	*	4/2008	Kim et al.	D14/138 AA
D576,988	S	*	9/2008	Kim et al.	D14/138 AA
D582,914	S	*	12/2008	Croley et al.	D14/341
D591,278	S	*	4/2009	Rouger	D14/247
D591,742	S	*	5/2009	Hofer et al.	D14/346
7,565,183	B2	*	7/2009	Vance et al.	455/575.1
D599,770	S	*	9/2009	Salmi et al.	D14/138 AD
D600,229	S		9/2009	Kangasmaa		
D600,231	S	*	9/2009	Lee et al.	D14/138 AA
D601,529	S	*	10/2009	Rouger	D14/138 AA
D603,833	S	*	11/2009	Ho et al.	D14/138 AA
D606,039	S	*	12/2009	Henning	D14/138 AA
D606,955	S	*	12/2009	Salmi	D14/138 AA
D607,866	S	*	1/2010	Kim et al.	D14/138 AA
D607,868	S	*	1/2010	Kim et al.	D14/138 AA
D612,849	S	*	3/2010	Ferrari et al.	D14/346
D614,159	S	*	4/2010	Lee et al.	D14/138 AA

D615,061	S	*	5/2010	Choi et al.	D14/138 AA
D615,062	S	*	5/2010	Tsai et al.	D14/138 AA
D615,088	S	*	5/2010	Matsuoka	D14/439
D615,524	S	*	5/2010	He	D14/138 AA

(Continued)

OTHER PUBLICATIONS

Nokia C3 telephone, announced Apr. 2010, [online], [site visited Dec. 3, 2010]. Available from Internet, <URL: <http://www.gsmarena.com>>.*

(Continued)

Primary Examiner — Jeffrey D Asch

(74) *Attorney, Agent, or Firm* — Banner & Witcoff, Ltd.

(57) **CLAIM**

The ornamental design for a handset, as shown and described.

DESCRIPTION

FIG. 1 is a perspective front view of a handset showing our new design;

FIG. 2 is a front view thereof;

FIG. 3 is a rear view thereof;

FIG. 4 is left side view thereof;

FIG. 5 is a right side view thereof;

FIG. 6 is a top view thereof;

FIG. 7 is a bottom view thereof.

FIG. 8 is a perspective front view of a handset showing our new design;

FIG. 9 is a front view thereof;

FIG. 10 is a rear view thereof;

FIG. 11 is a left side view thereof;

FIG. 12 is a right side view thereof;

FIG. 13 is a top view thereof; and,

FIG. 14 is a bottom view thereof.

The broken line showing of the environment of the handset in FIGS. 1-7 is for illustrative purposes only and forms no part of the embodiment in which they are shown. The unshaded regions within the boundaries formed by the broken lines are not a part of the embodiment in which they are shown.

1 Claim, 10 Drawing Sheets

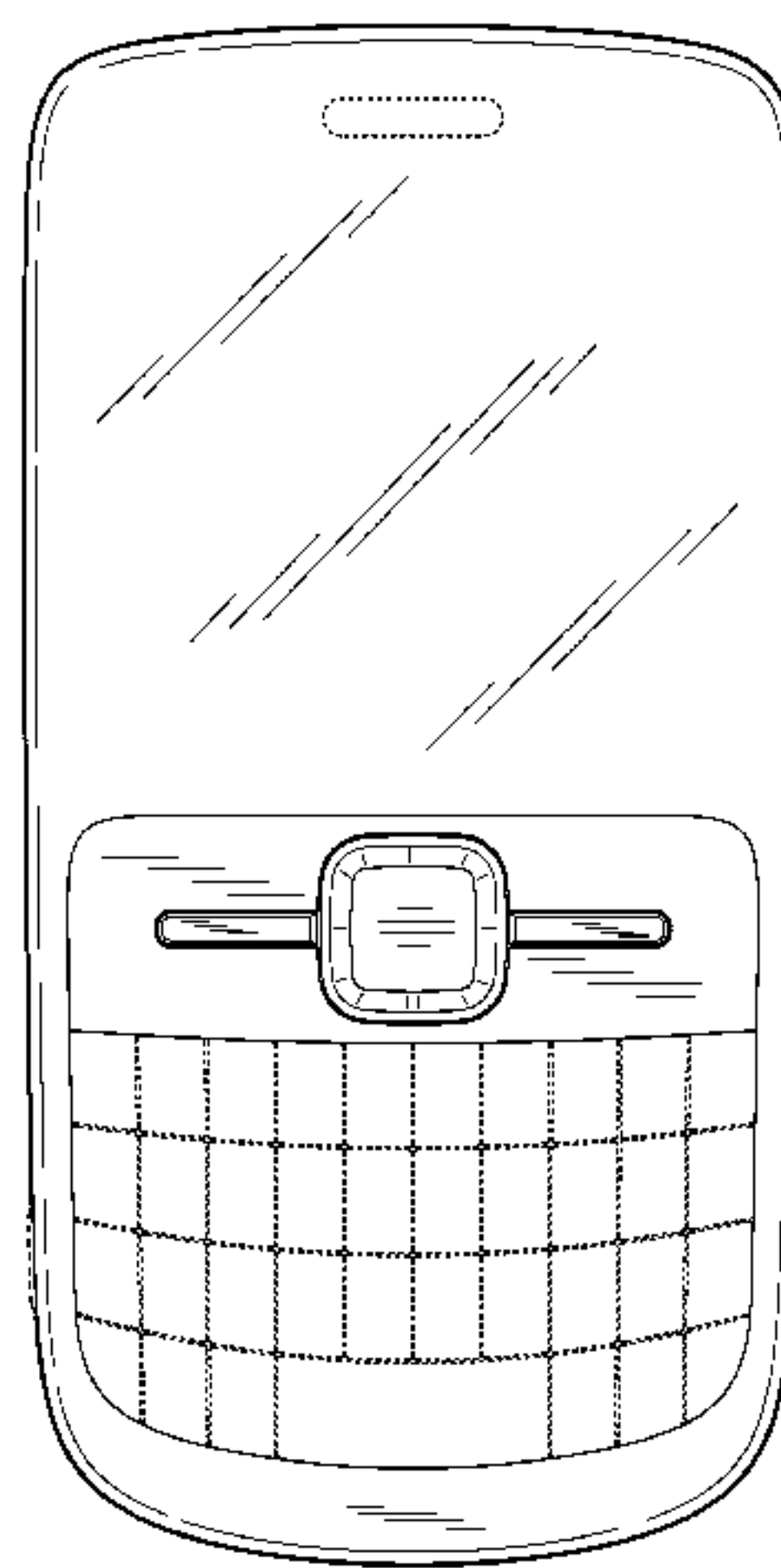
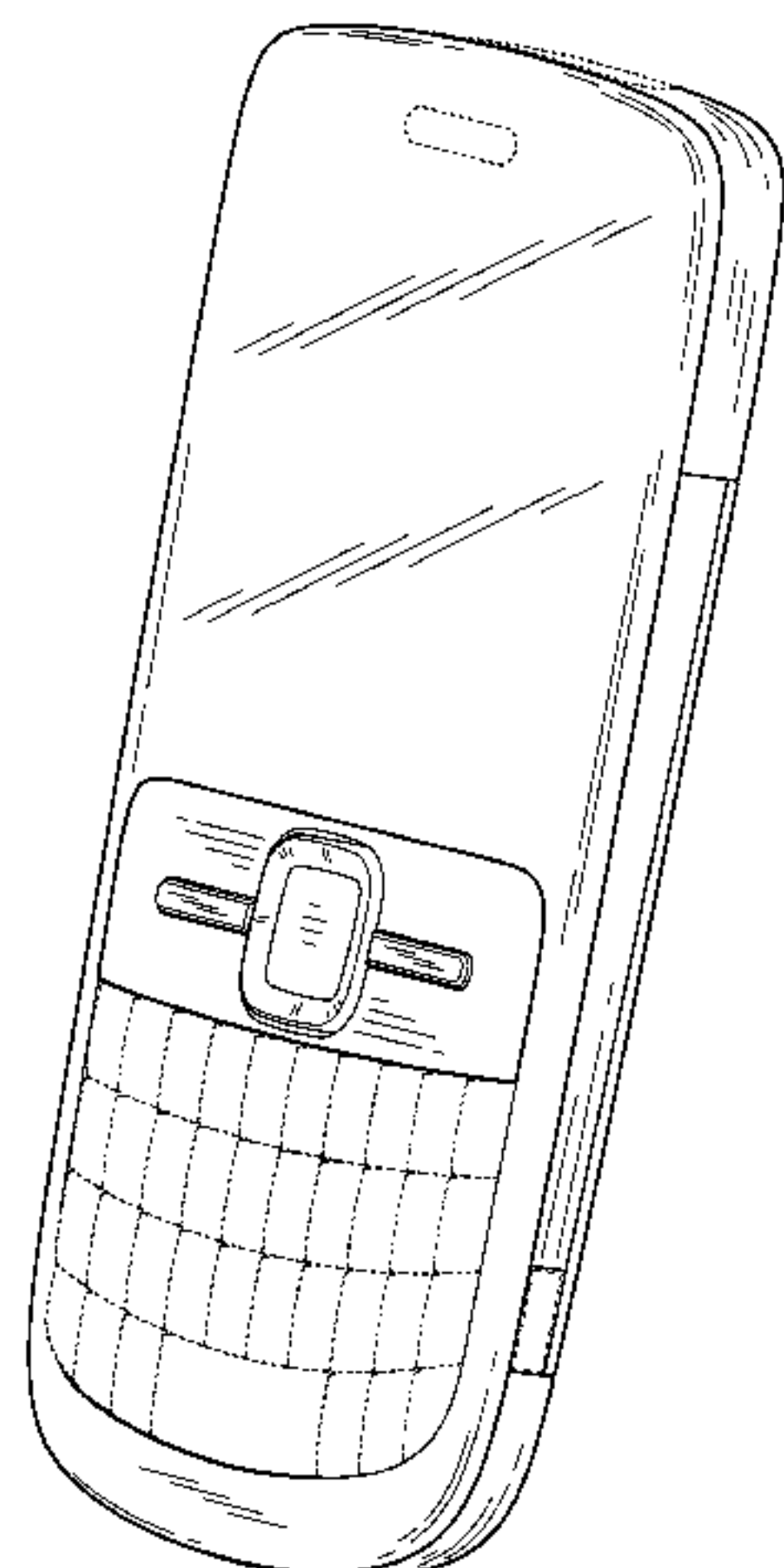

U.S. PATENT DOCUMENTS

D615,953	S	*	5/2010	Lee et al.	D14/138 AA
D617,752	S	*	6/2010	Montin	D14/138 AA
D622,247	S	*	8/2010	Kwon et al.	D14/138 AA
D623,163	S	*	9/2010	Choi et al.	D14/138 AA
D626,929	S	*	11/2010	Ge	D14/138 AB
D628,187	S	*	11/2010	Huang	D14/138 AA
2009/0174666	A1	*	7/2009	Matsuoka	345/169
2009/0209301	A1	*	8/2009	Lin et al.	455/575.1

OTHER PUBLICATIONS

Nokia E5 telephone, announced Apr. 2010, [online], [site visited Dec. 3, 2010]. Available from Internet ,<URL: <http://www.gsmarena.com>>.*

LG C105 telephone, announced Jul. 2010, [online], [site visited Dec. 3, 2010]. Available from Internet ,<URL: <http://www.gsmarena.com>>.*

Micromax Q3 telephone, announced Jun. 2009, [online], [site visited Dec. 3, 2010]. Available from Internet ,<URL: <http://www.gsmarena.com>>.*

Huawei U9130 Compass telephone, announced Dec. 2009, [online], [site visited Dec. 3, 2010]. Available from Internet ,<URL: <http://www.gsmarena.com>>.*

Haier U53 telephone, announced 2010, [online], [site visited Dec. 3, 2010]. Available from Internet ,<URL: <http://www.gsmarena.com>>.*

Vodafone 1240 telephone, announced Nov. 2009, [online], [site visited Dec. 3, 2010]. Available from Internet ,<URL: <http://www.gsmarena.com>>.*

Nokia E72 telephone, announced Jun. 2009, [online], [site visited Dec. 3, 2010]. Available from Internet ,<URL: <http://www.gsmarena.com>>.*

Spice QT-61 telephone, announced 2010, [online], [site visited Dec. 3, 2010]. Available from Internet ,<URL: <http://www.gsmarena.com>>.*

Samsung B7330 OmniaPRO telephone, announced Sep. 2009, [online], [site visited Dec. 3, 2010]. Available from Internet ,<URL: <http://www.gsmarena.com>>.*

Palm Pixi telephone, announced Sep. 2009, [online], [site visited Dec. 3, 2010]. Available from Internet ,<URL: <http://www.gsmarena.com>>.*

Nokia Model # E55, Nokia Corporation, 1 color sheet of photographs, disclosed on or about Feb. 2009.

* cited by examiner

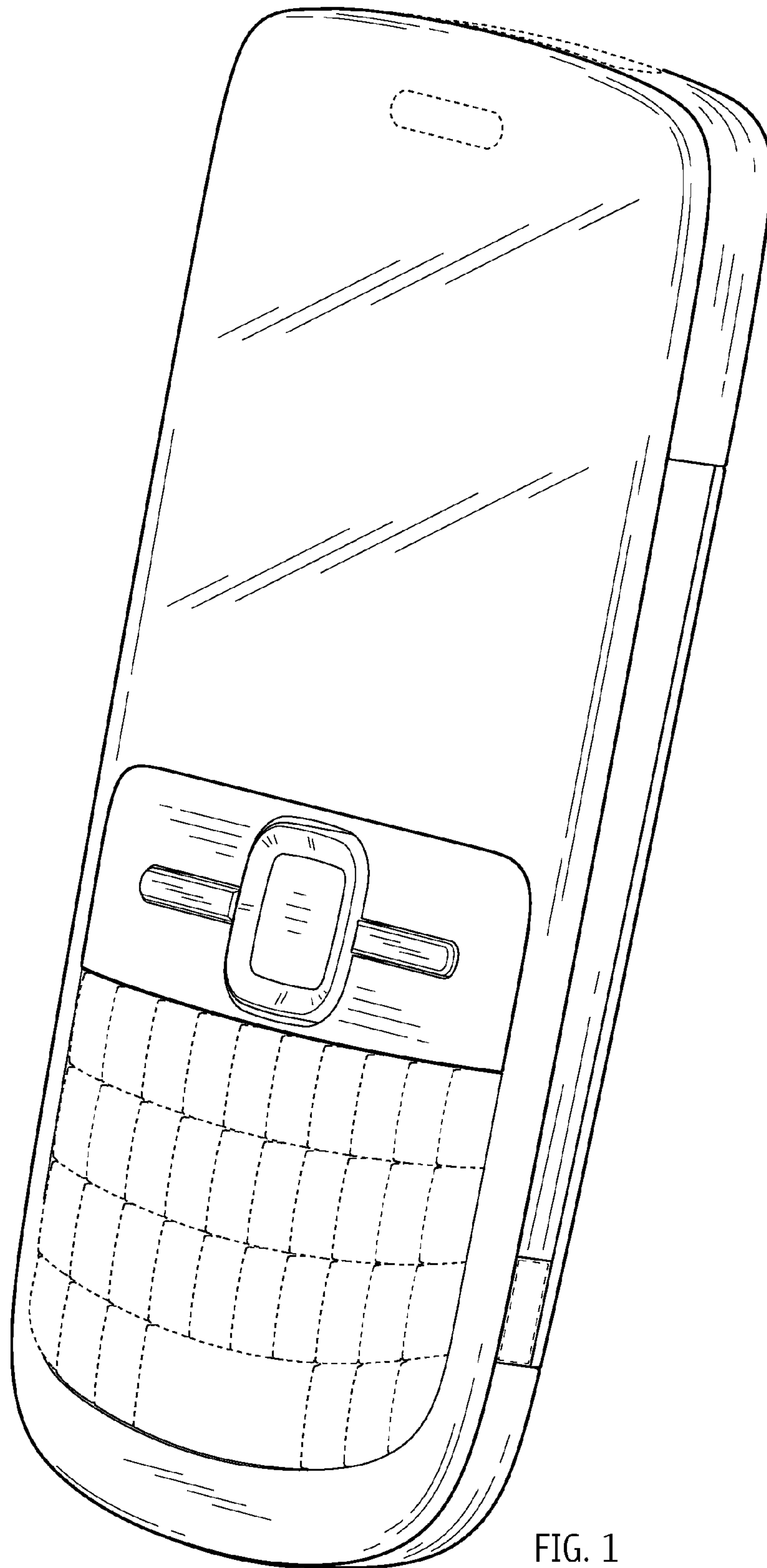

FIG. 1

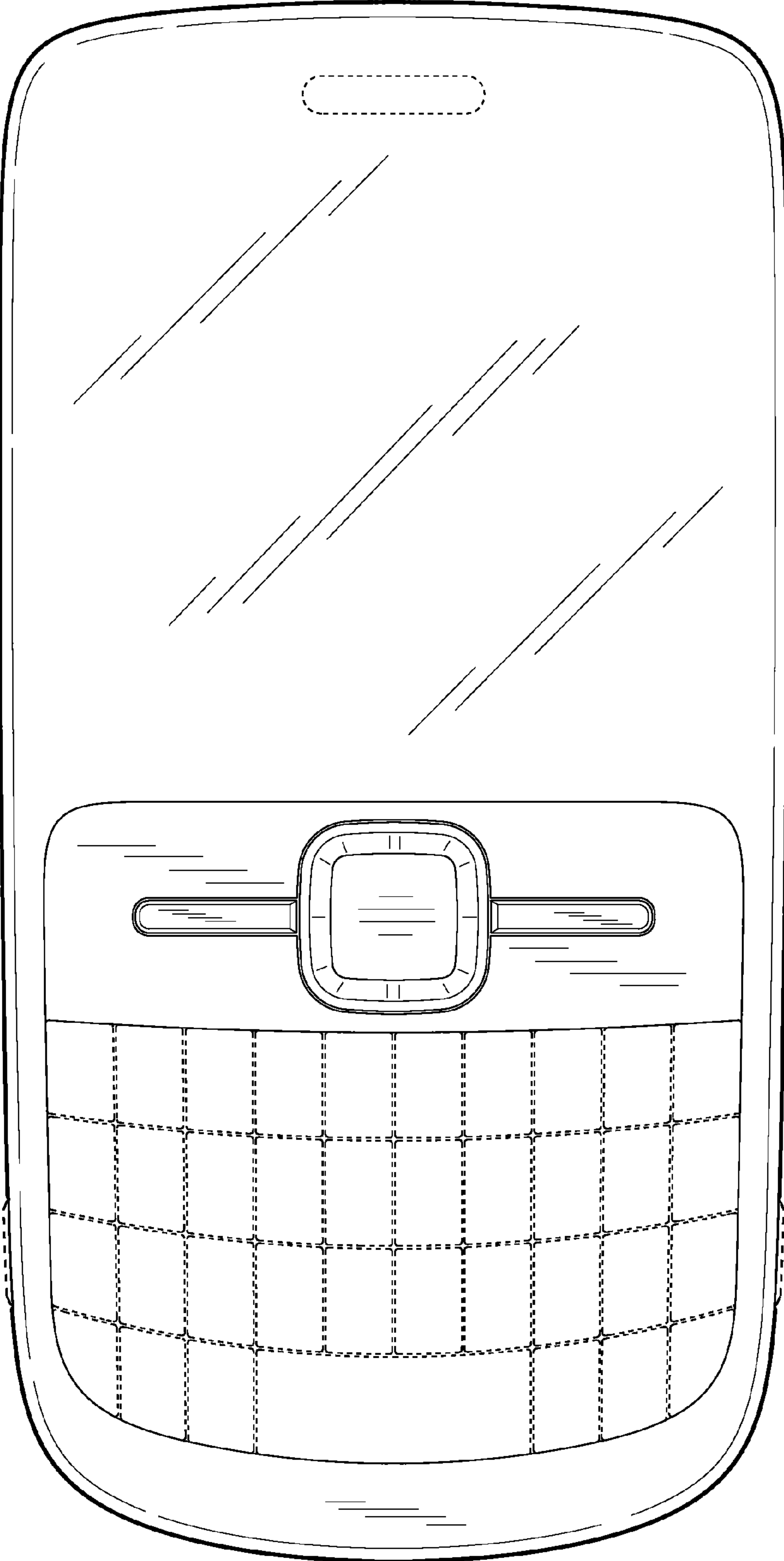

FIG. 2

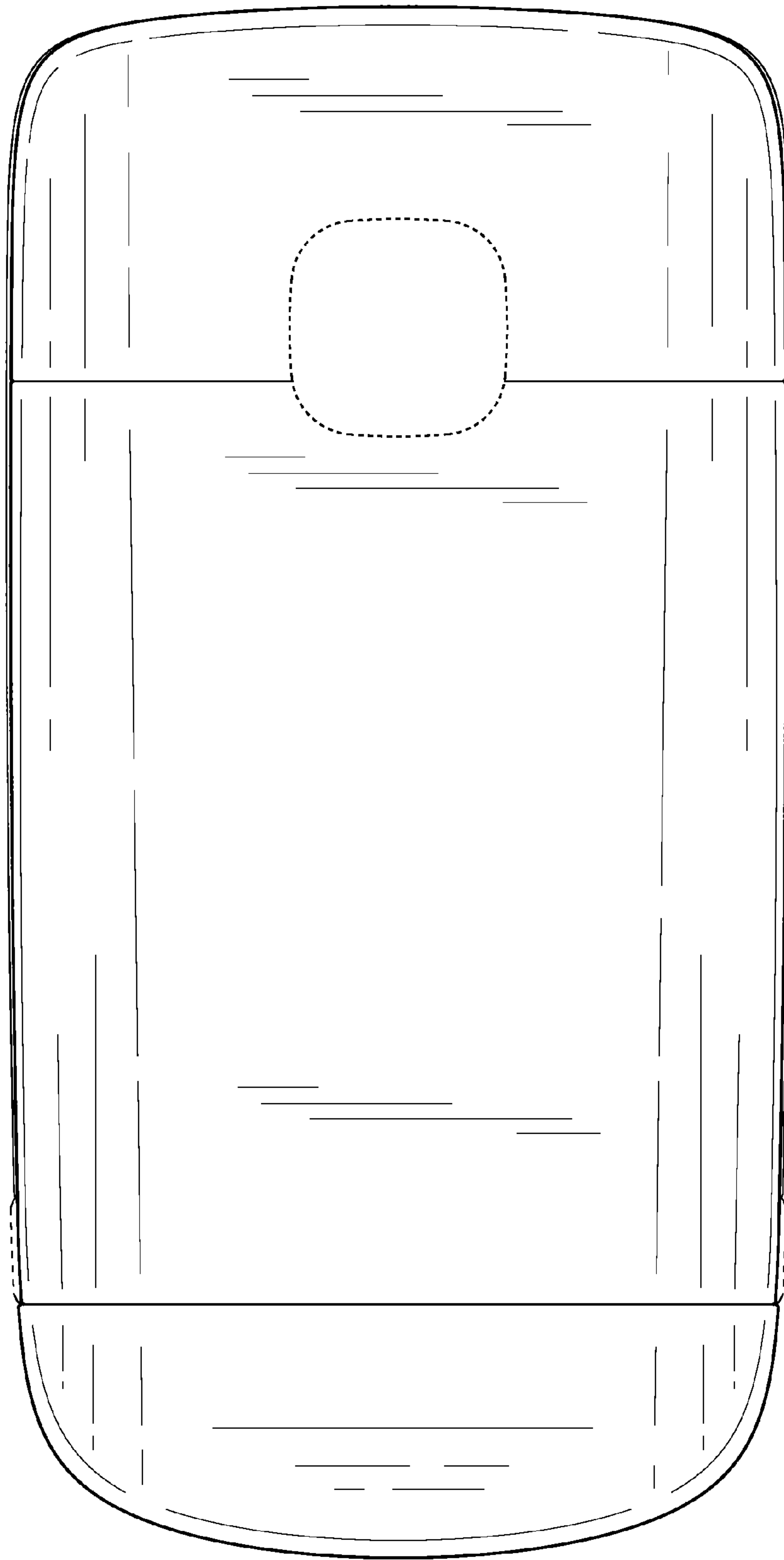

FIG. 3



FIG. 4

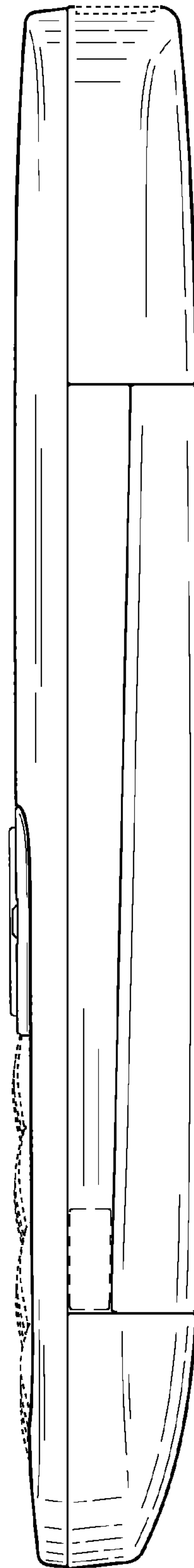

FIG. 5

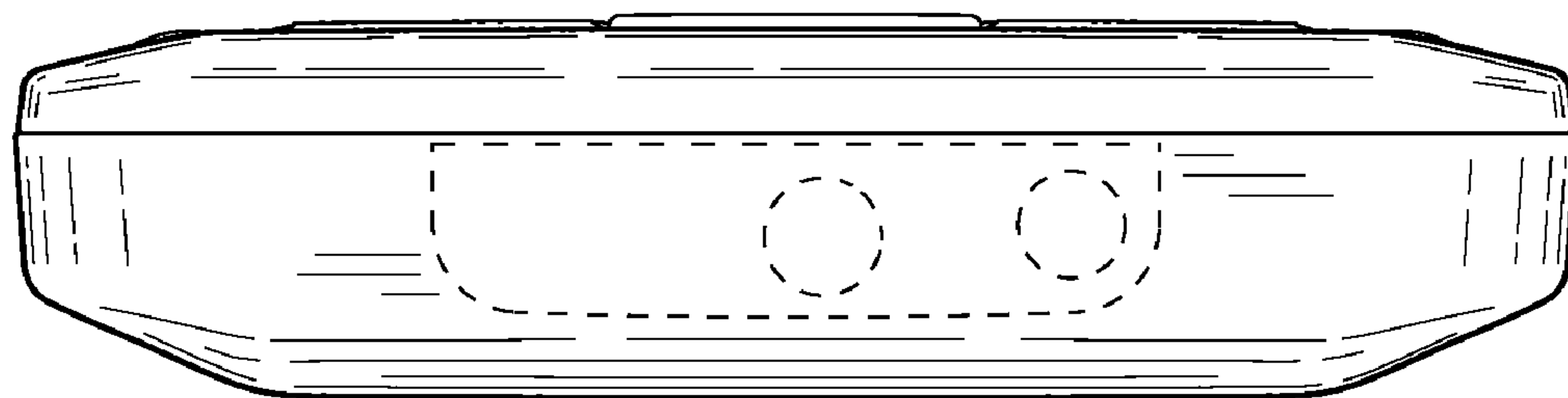

FIG. 6

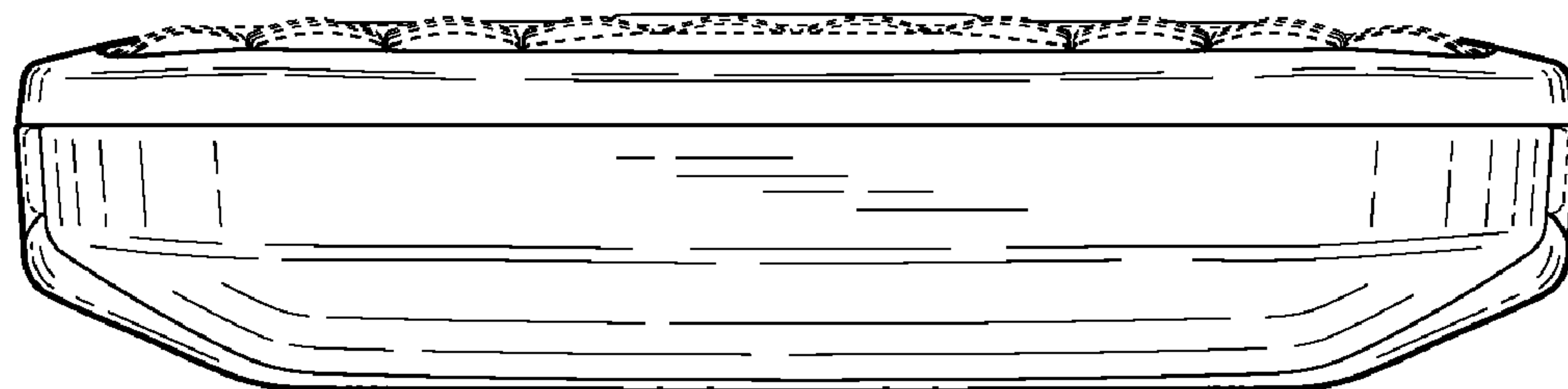

FIG. 7

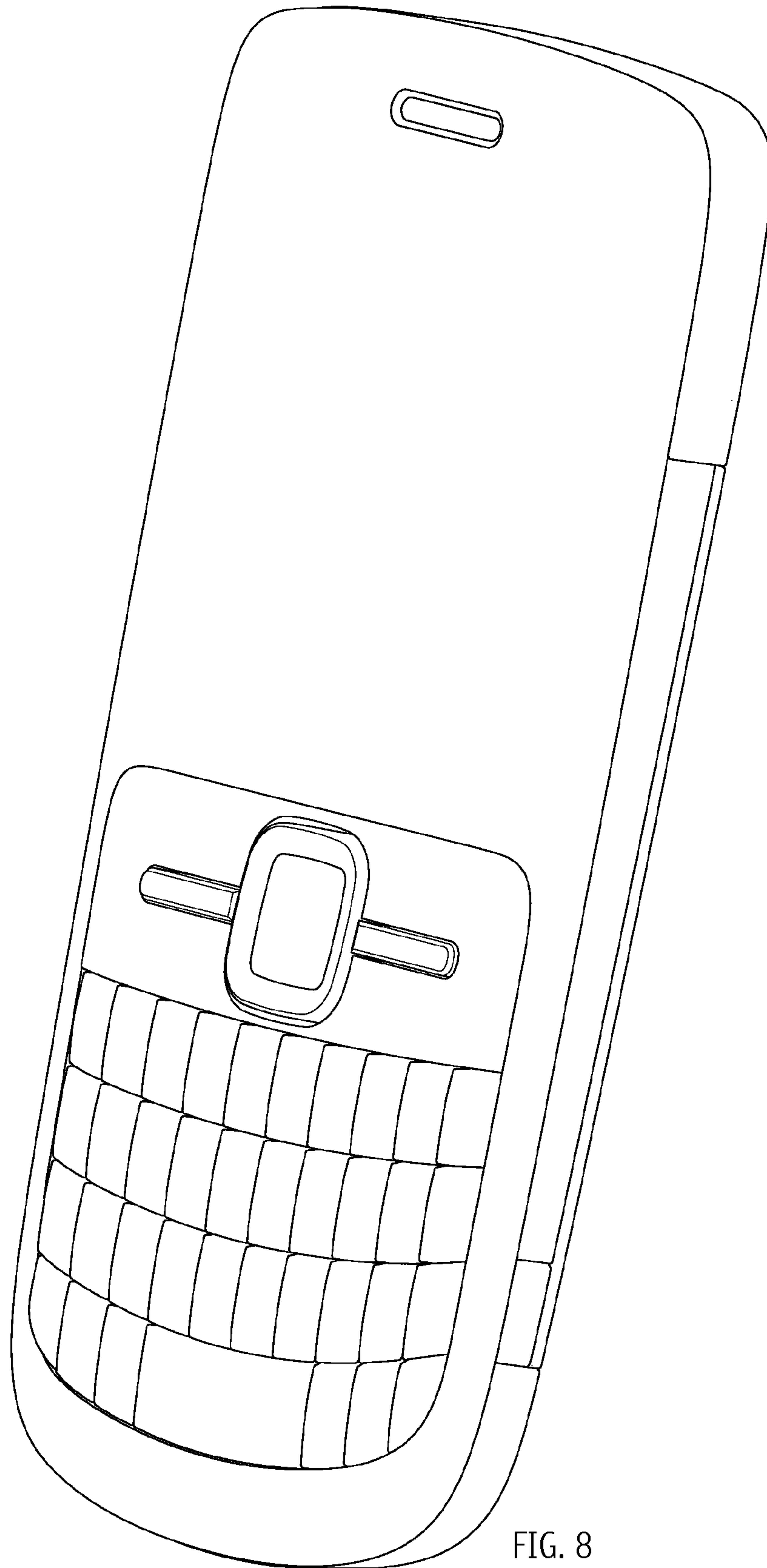

FIG. 8

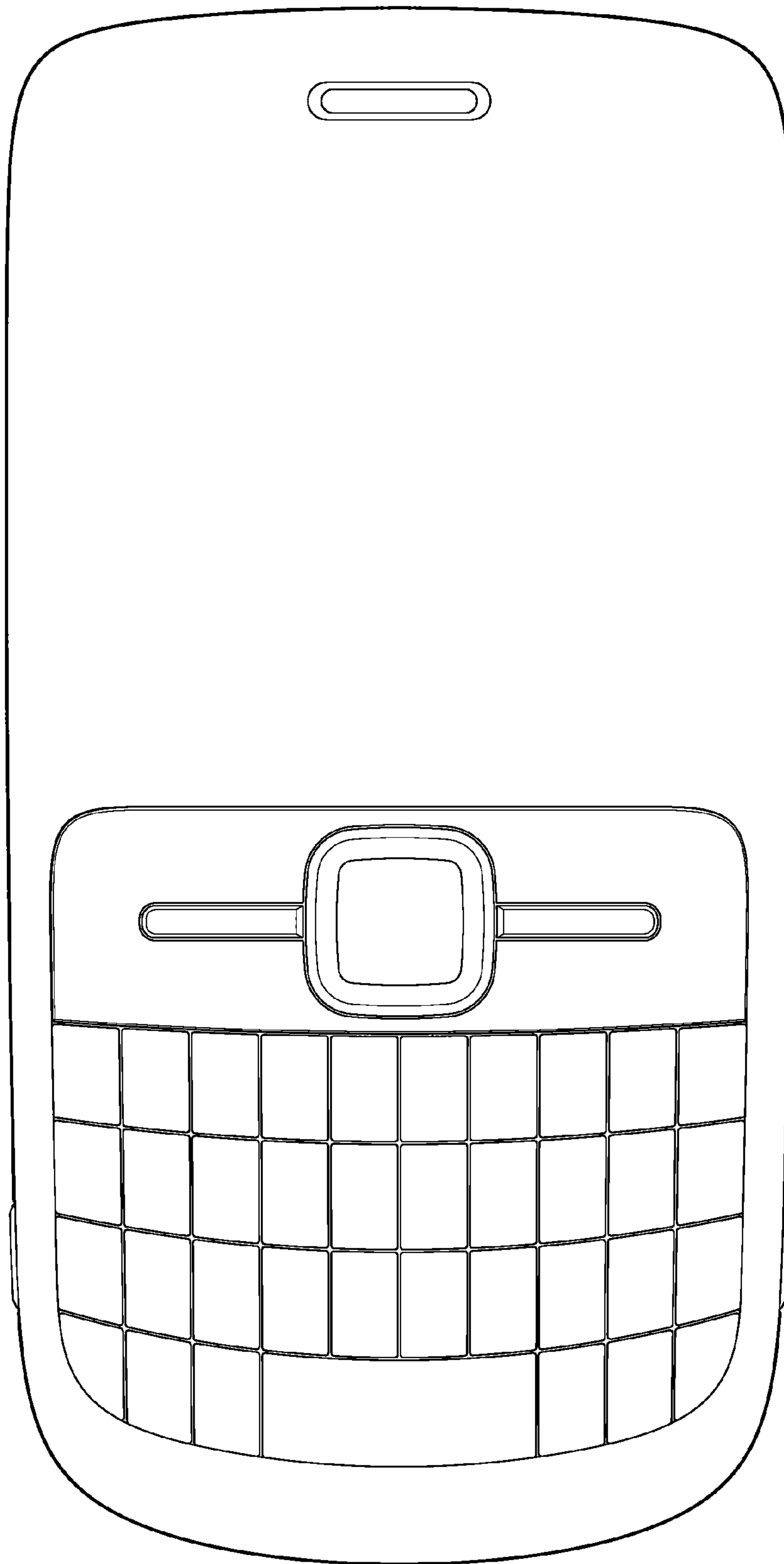

FIG. 9

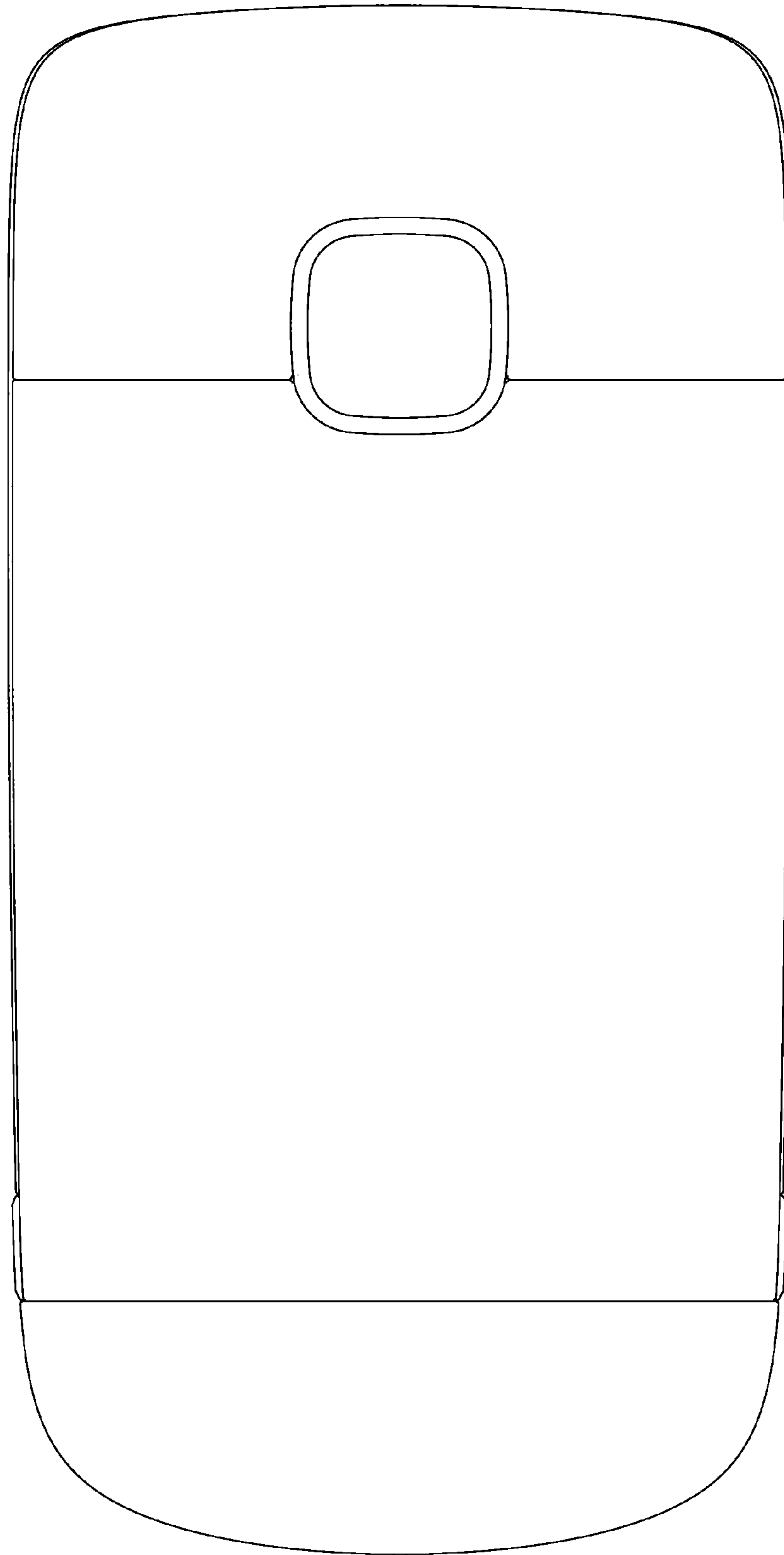

FIG. 10

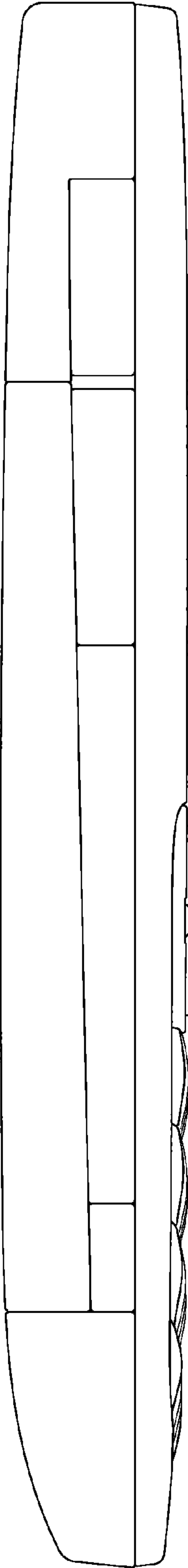

FIG. 11

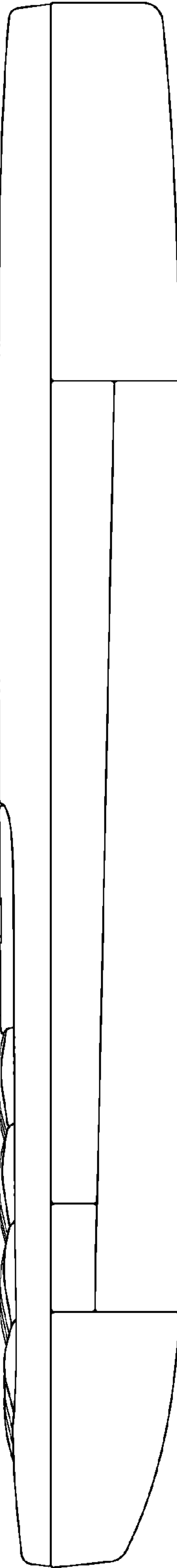

FIG. 12

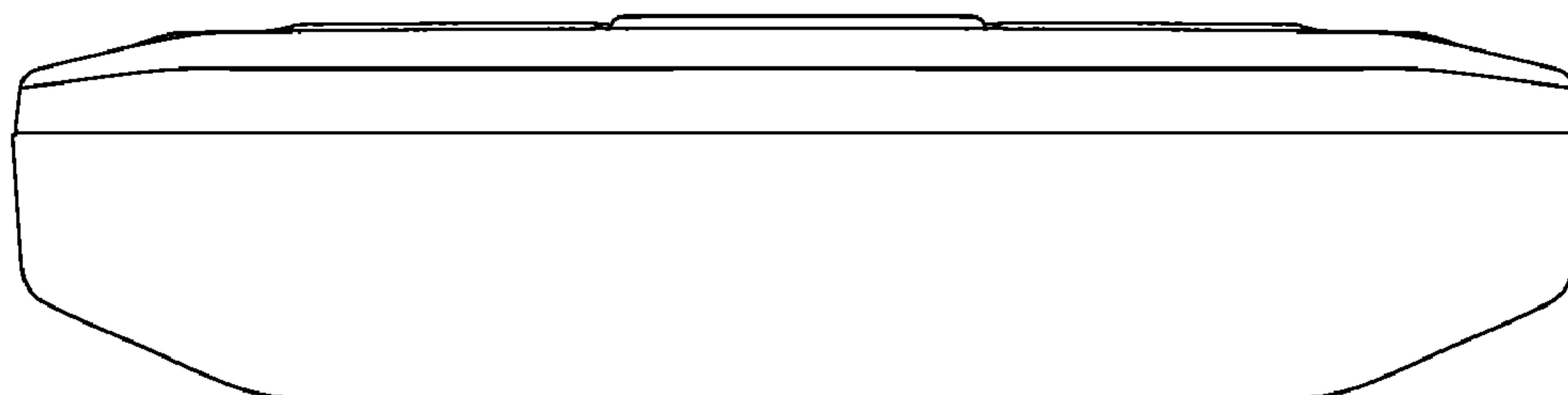

FIG. 13

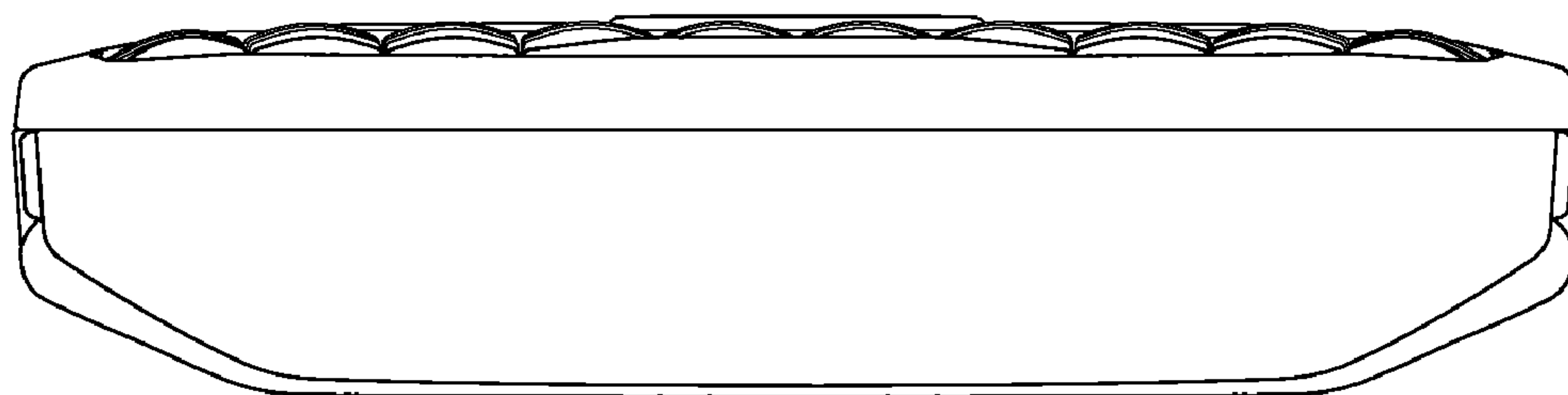

FIG. 14