



US00D636353S

(12) **United States Design Patent**
Choi et al.

(10) **Patent No.:** **US D636,353 S**

(45) **Date of Patent:** **** Apr. 19, 2011**

(54) **REMOTE CONTROLLER FOR AIR
CONDITIONER**

(75) Inventors: **Eun Ha Choi**, Seoul (KR); **Ji Hyeoung
Lee**, Seoul (KR)

(73) Assignee: **Samsung Electronics Co., Ltd.**, Suwon
(KR)

(**) Term: **14 Years**

(21) Appl. No.: **29/376,589**

(22) Filed: **Oct. 8, 2010**

(51) **LOC (9) Cl.** **14-03**

(52) **U.S. Cl.** **D13/168**

(58) **Field of Classification Search** D13/168;
D10/104, 106; D14/218, 247; 340/825.22,
340/825.24, 825.25, 825.31, 825.36, 825.69,
340/825.72; 341/176; 455/352; 345/156,
345/169; 348/734; 463/39; 700/17, 65,
700/83

See application file for complete search history.

(56) **References Cited**

U.S. PATENT DOCUMENTS

D387,061 S * 12/1997 Nozoe D14/218
D451,891 S * 12/2001 Noonan et al. D13/168

6,359,661 B1 * 3/2002 Nickum 348/734
D549,667 S * 8/2007 Huang D13/168
D573,548 S * 7/2008 Chouji et al. D13/168
D607,845 S * 1/2010 Daniels D13/168
D618,628 S * 6/2010 Giugiaro D13/168
D619,107 S * 7/2010 Giugiaro D13/168
D621,370 S * 8/2010 Chouji et al. D13/168
2007/0279246 A1 * 12/2007 Hudspeth 340/825.69

* cited by examiner

Primary Examiner — Selina Sikder

(74) *Attorney, Agent, or Firm* — Ladas & Parry LLP

(57) **CLAIM**

We claim the ornamental design for a remote controller for air conditioner, as shown.

DESCRIPTION

FIG. 1 is a front/right-side/top perspective view of a remote controller for air conditioner showing our new design;
FIG. 2 is a front elevational view thereof;
FIG. 3 is a rear elevational view thereof;
FIG. 4 is a left-side elevational view thereof;
FIG. 5 is a right-side elevational view thereof;
FIG. 6 is a top plan view thereof; and,
FIG. 7 is a bottom plan view thereof.

1 Claim, 6 Drawing Sheets

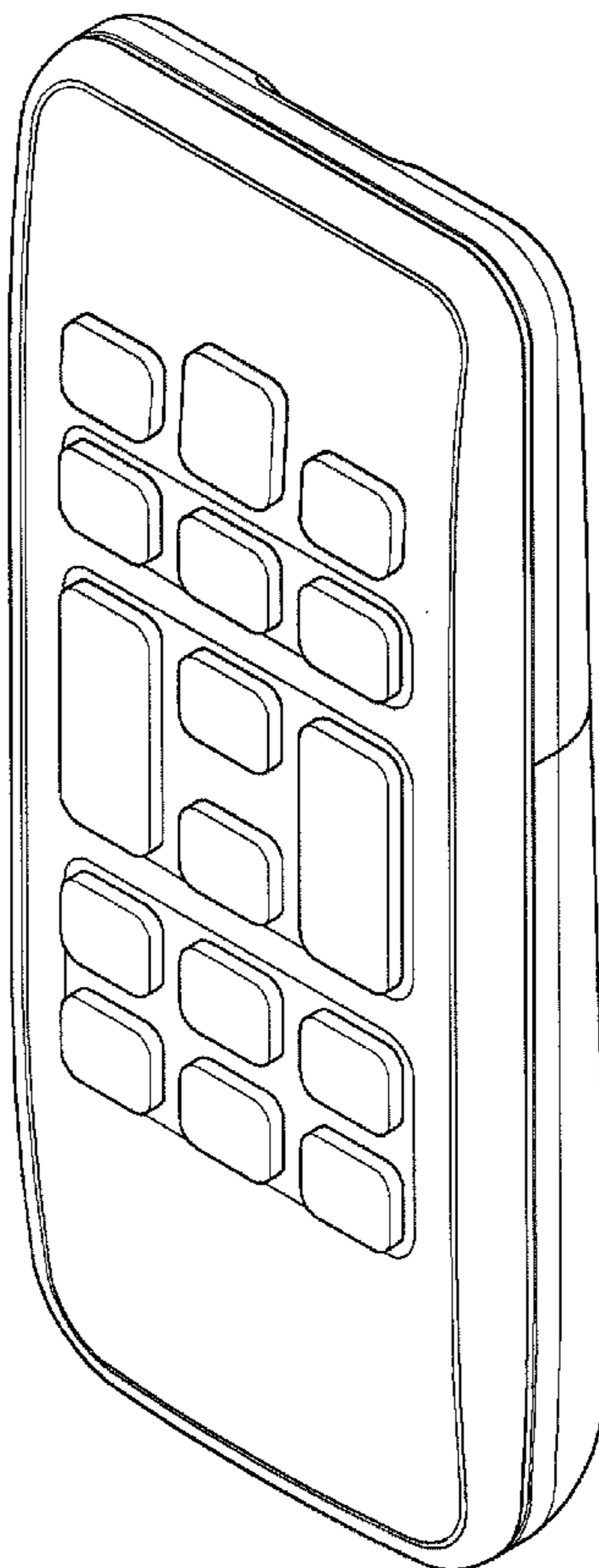

FIG. 1

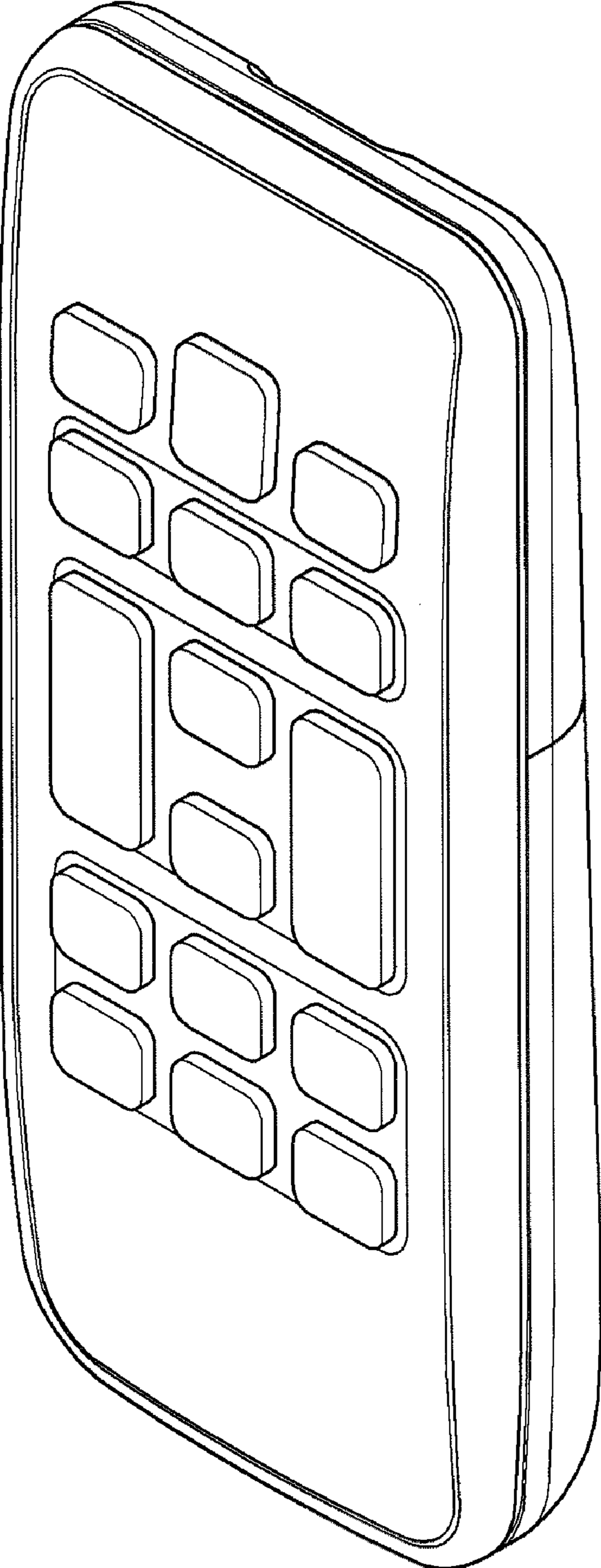

FIG. 2

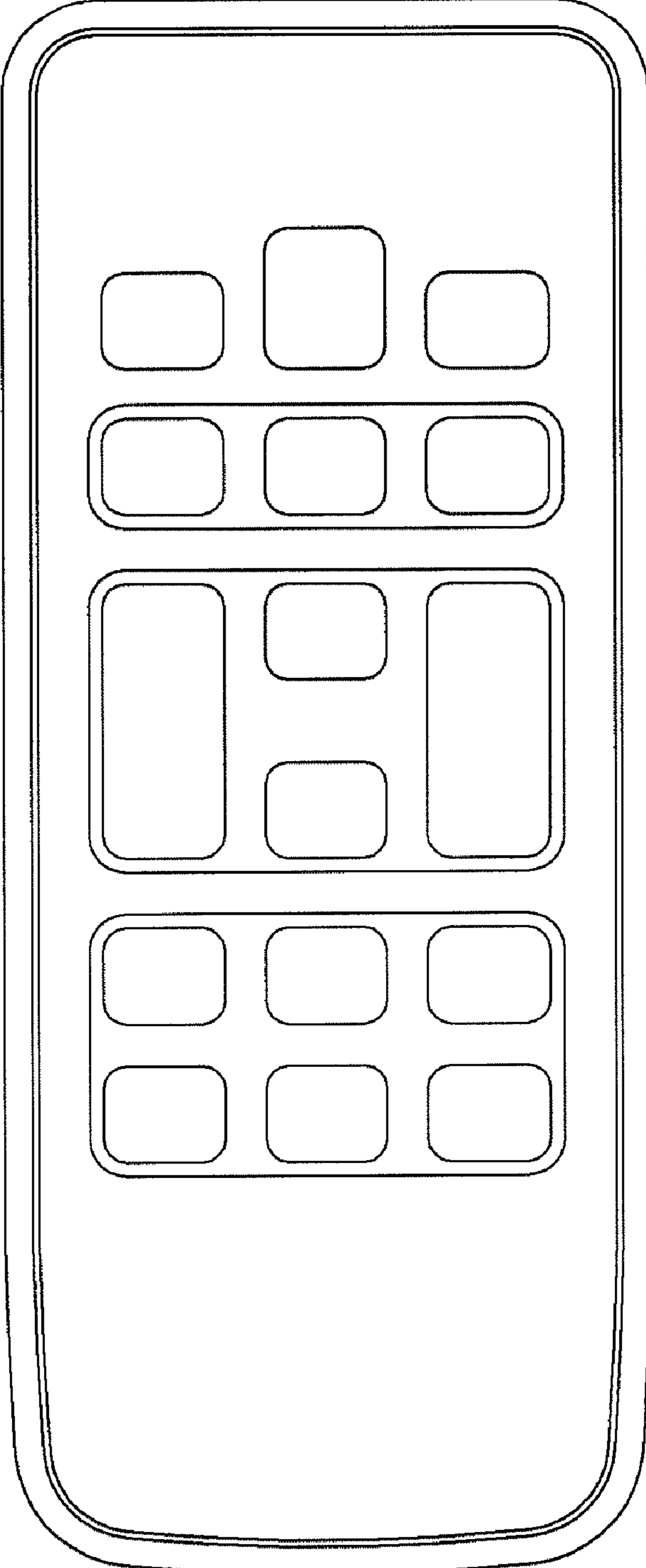

FIG. 3

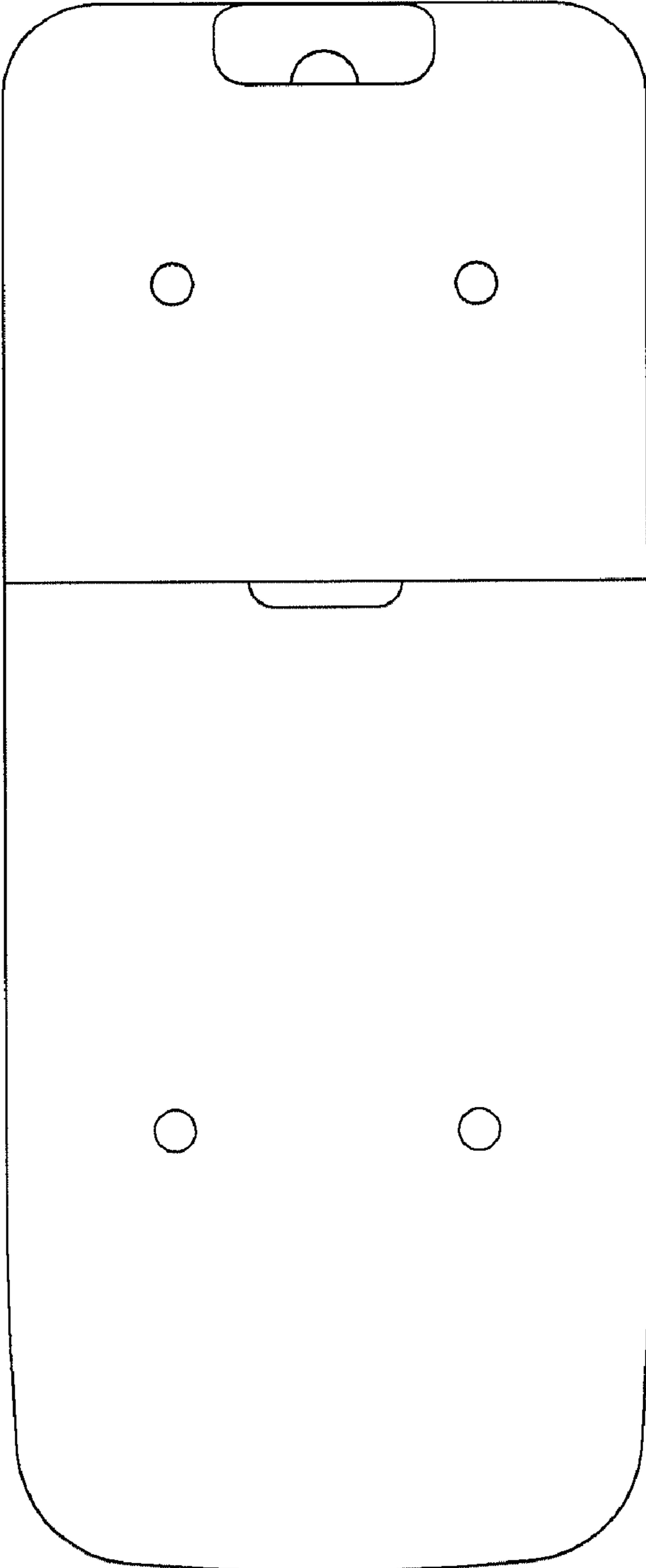

FIG. 4

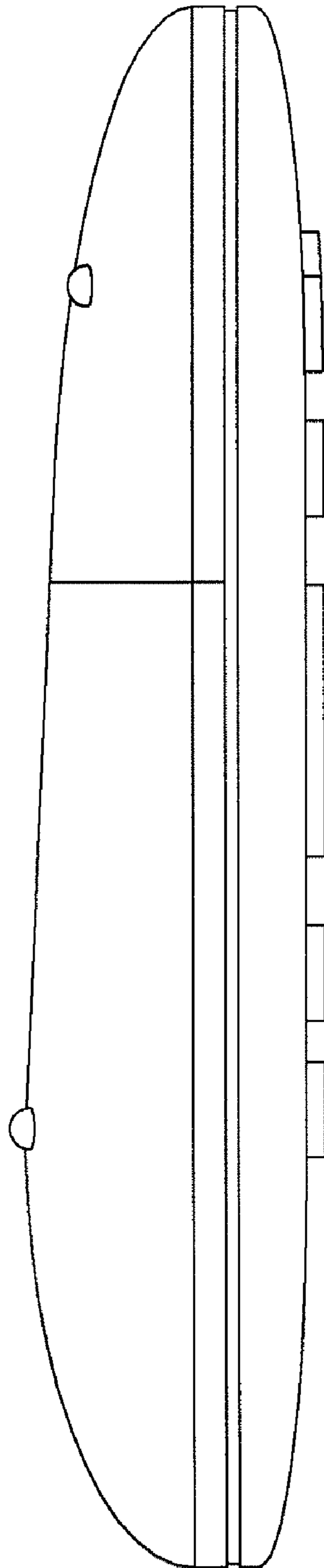

FIG. 5

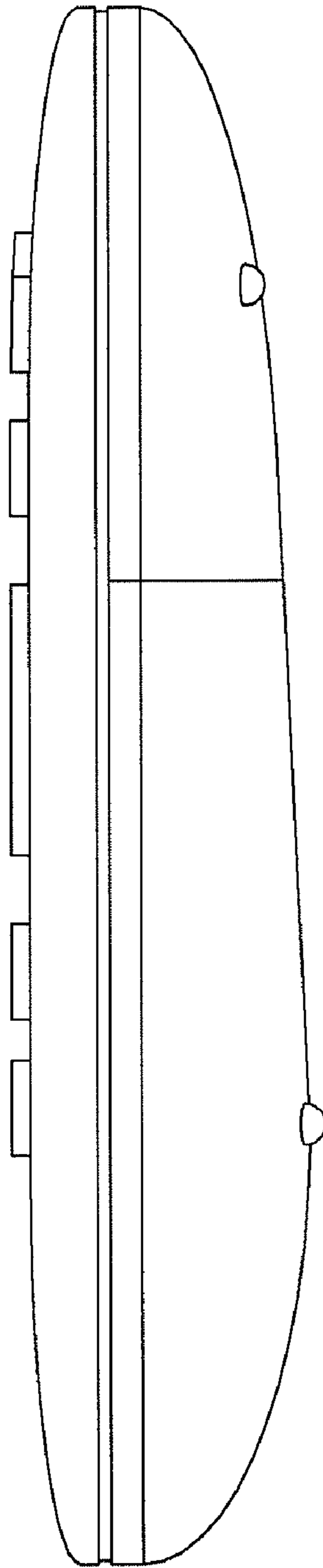

FIG. 6

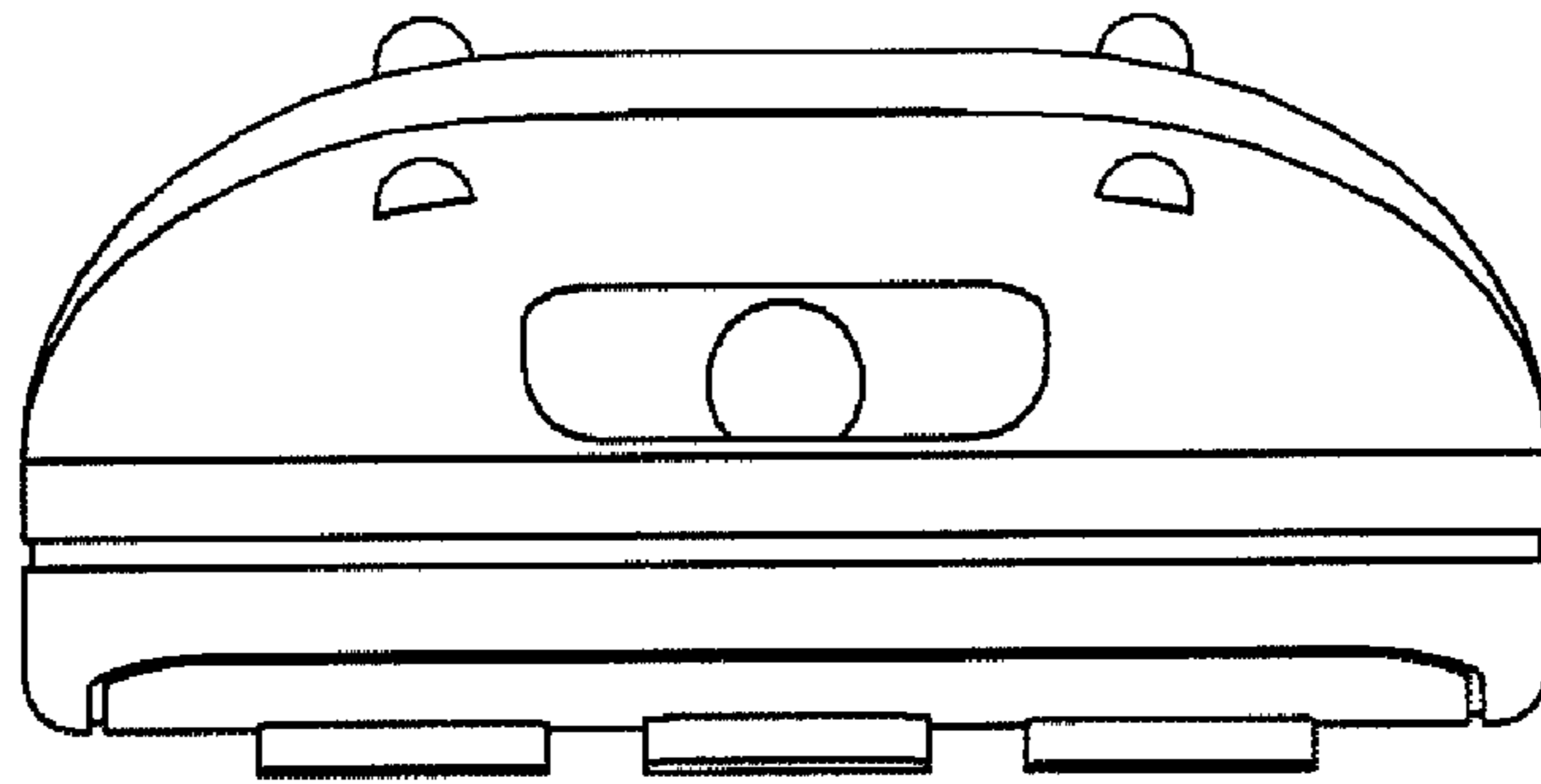

FIG. 7

