



US00D636325S

(12) **United States Design Patent**  
**Marsh**

(10) **Patent No.:** **US D636,325 S**

(45) **Date of Patent:** **\*\* Apr. 19, 2011**

(54) **DECORATIVE ACCESSORY SLEEVE FOR AN  
AUTOMOTIVE MIRROR**

(76) Inventor: **Christopher J. Marsh**, Peoria, IL (US)

(\*\*) Term: **14 Years**

(21) Appl. No.: **29/376,722**

(22) Filed: **Oct. 11, 2010**

(51) **LOC (9) Cl.** ..... **12-16**

(52) **U.S. Cl.** ..... **D12/401; D12/188**

(58) **Field of Classification Search** ..... D12/401,  
D12/188, 187, 189; D21/754; D3/299, 300,  
D3/303; 40/518; 248/475.1, 476-483; 359/855,  
359/838, 841, 842-844, 868, 871, 604, 881,  
359/514, 866; 259/868; D6/300, 309  
See application file for complete search history.

(56) **References Cited**

**U.S. PATENT DOCUMENTS**

260,576	A *	7/1882	Roberdeaux	.....	172/369
606,107	A *	6/1898	Siims	.....	24/323
3,426,815	A *	2/1969	Ashlin et al.	.....	150/160
4,915,488	A *	4/1990	Lambert et al.	.....	359/608
4,974,355	A *	12/1990	Abrams	.....	40/591
D330,927	S *	11/1992	Diener et al.	.....	D21/754
D390,529	S *	2/1998	Adams et al.	.....	D12/401
D399,655	S *	10/1998	Maxham	.....	D3/303
D433,344	S *	11/2000	Hsu	.....	D10/72
D446,270	S *	8/2001	Bernath	.....	D21/754
6,325,121	B1 *	12/2001	Hudnall	.....	150/166
D550,457	S *	9/2007	Schlegel	.....	D3/300
D550,960	S *	9/2007	Schlegel	.....	D3/300

D555,572	S *	11/2007	Harrell	.....	D12/401
D576,939	S *	9/2008	Corley et al.	.....	D12/401
2010/0254034	A1 *	10/2010	Chiu	.....	359/843

\* cited by examiner

*Primary Examiner* — Caron Veynar

*Assistant Examiner* — Katrina A Kile

(74) *Attorney, Agent, or Firm* — H. Frederick Rusche;  
Husch Blackwell LLP

(57) **CLAIM**

I claim the ornamental design for an decorative accessory sleeve for an automotive mirror, as shown and described.

**DESCRIPTION**

FIG. 1 is a perspective view of a decorative accessory sleeve for an automotive mirror according to a first embodiment installed on an automotive mirror;

FIG. 2 is a front view of the embodiment of FIG. 1;

FIG. 3 is a rear view of the embodiment of FIG. 1;

FIG. 4 is a right side view of the embodiment of FIG. 1;

FIG. 5 is a left side view of the embodiment of FIG. 1;

FIG. 6 is a top view of the embodiment of FIG. 1;

FIG. 7 is a bottom view of the embodiment of FIG. 1;

FIG. 8 is a perspective view of a decorative accessory sleeve for an automotive mirror according to a second embodiment installed on an automotive mirror;

FIG. 9 is a front view of the embodiment of FIG. 8;

FIG. 10 is a rear view thereof of the embodiment of FIG. 8;

FIG. 11 is a right side view of the embodiment of FIG. 8;

FIG. 12 is a left side view of the embodiment of FIG. 8;

FIG. 13 is a top view of the embodiment of FIG. 8; and,

FIG. 14 is bottom view of the embodiment of FIG. 8.

The hidden lines appearing in the figures, and the automotive mirror represented thereby, form no part of the claimed design.

**1 Claim, 4 Drawing Sheets**

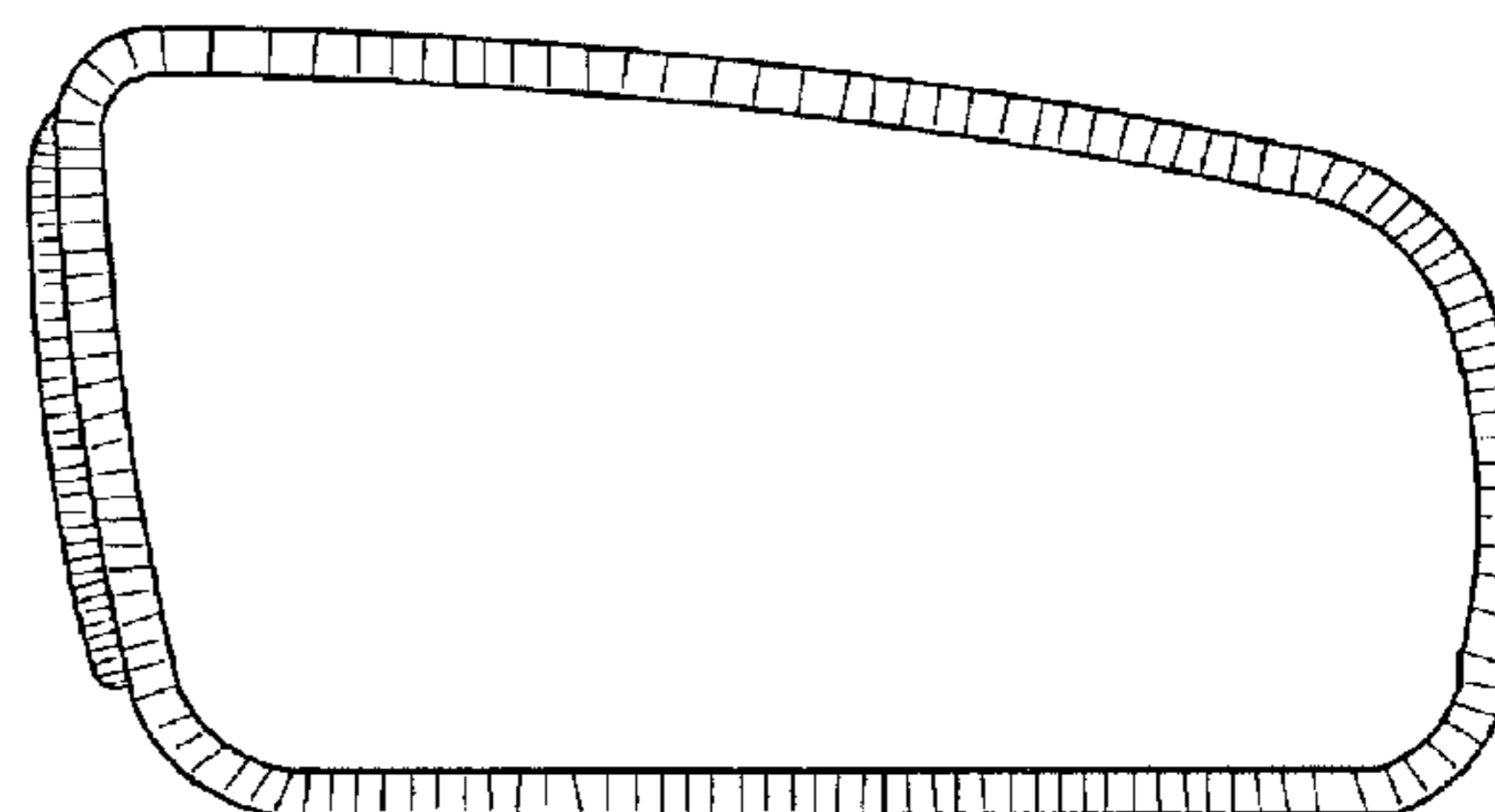
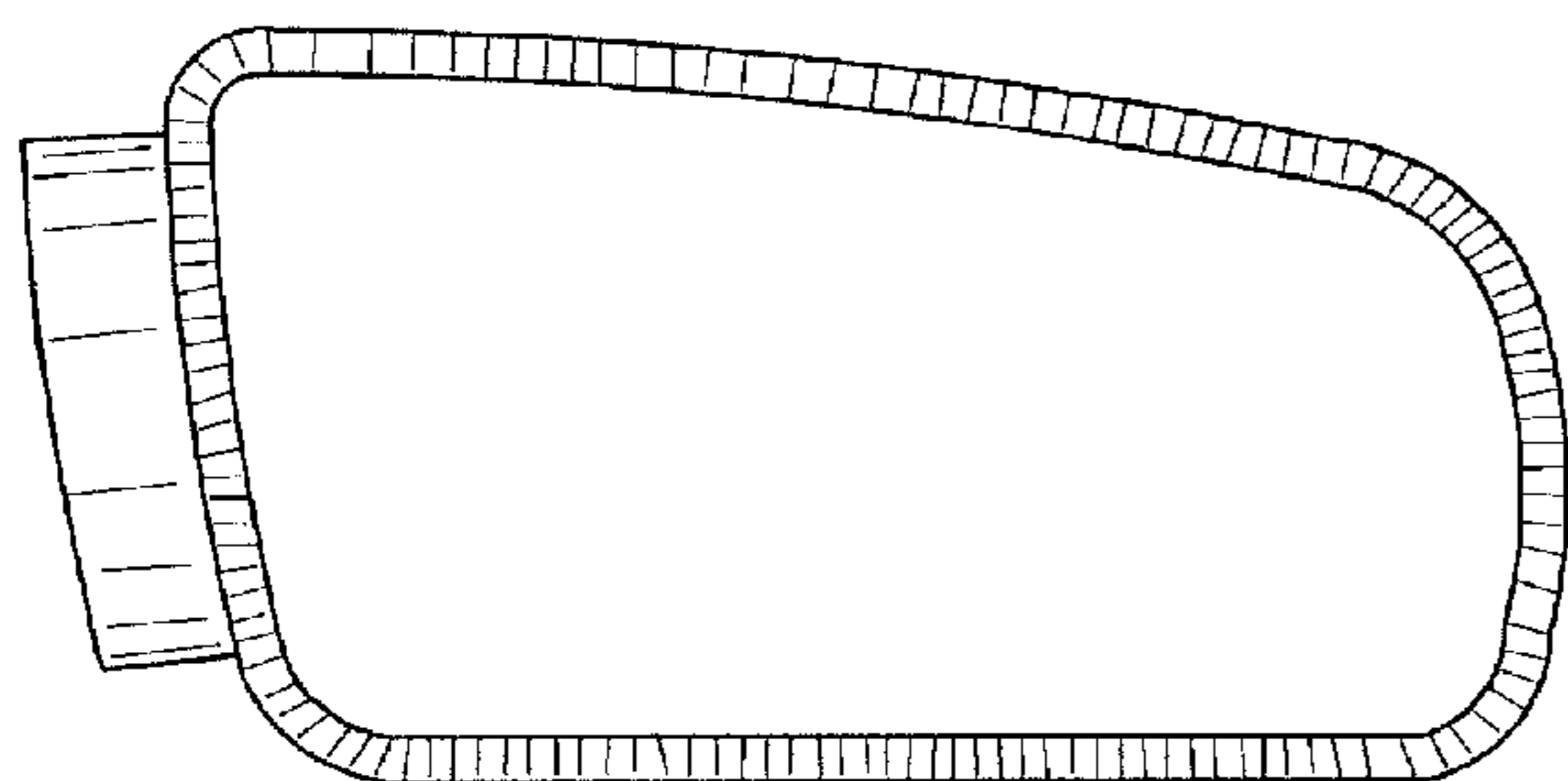

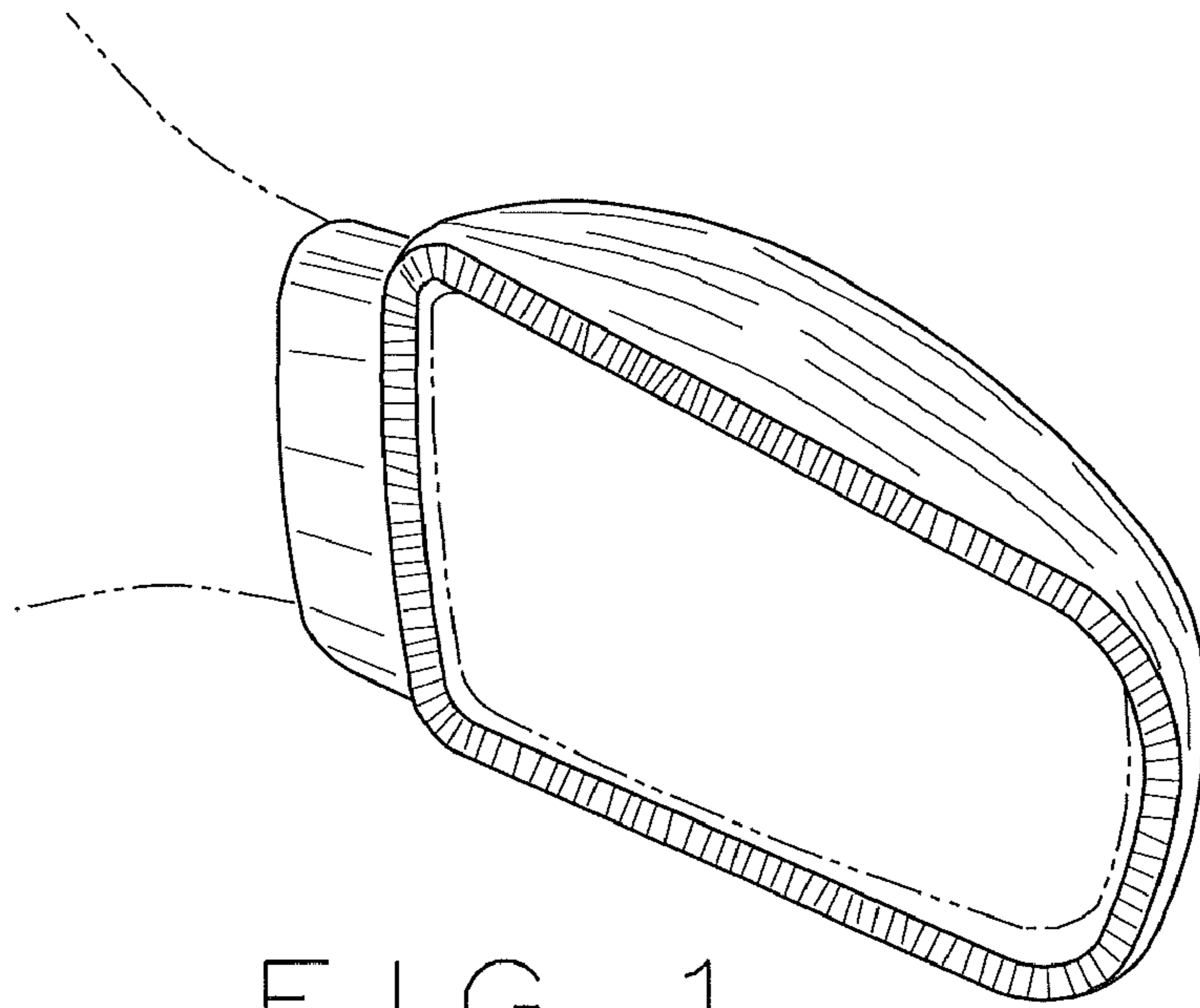

FIG. 1

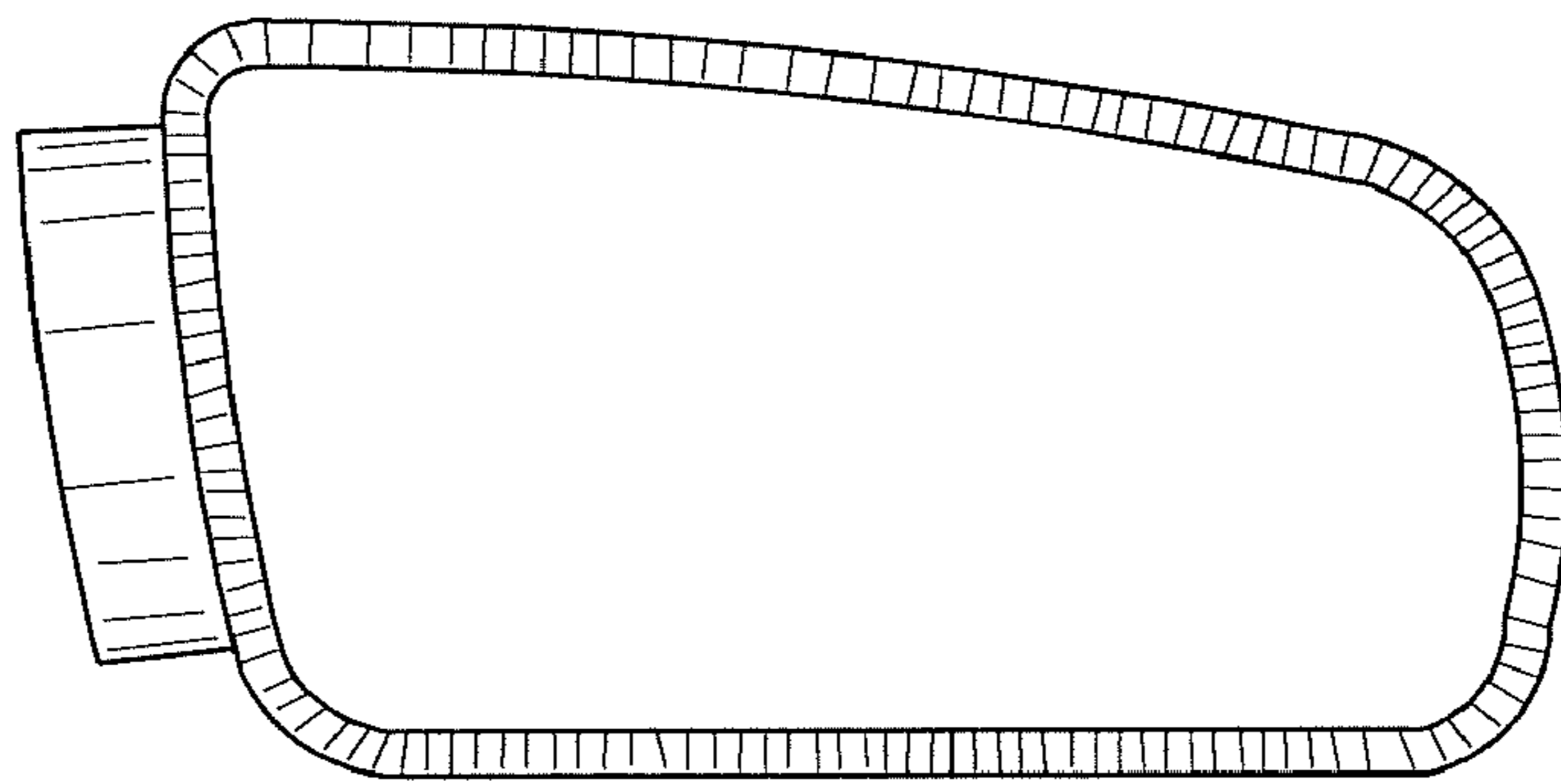

FIG. 2

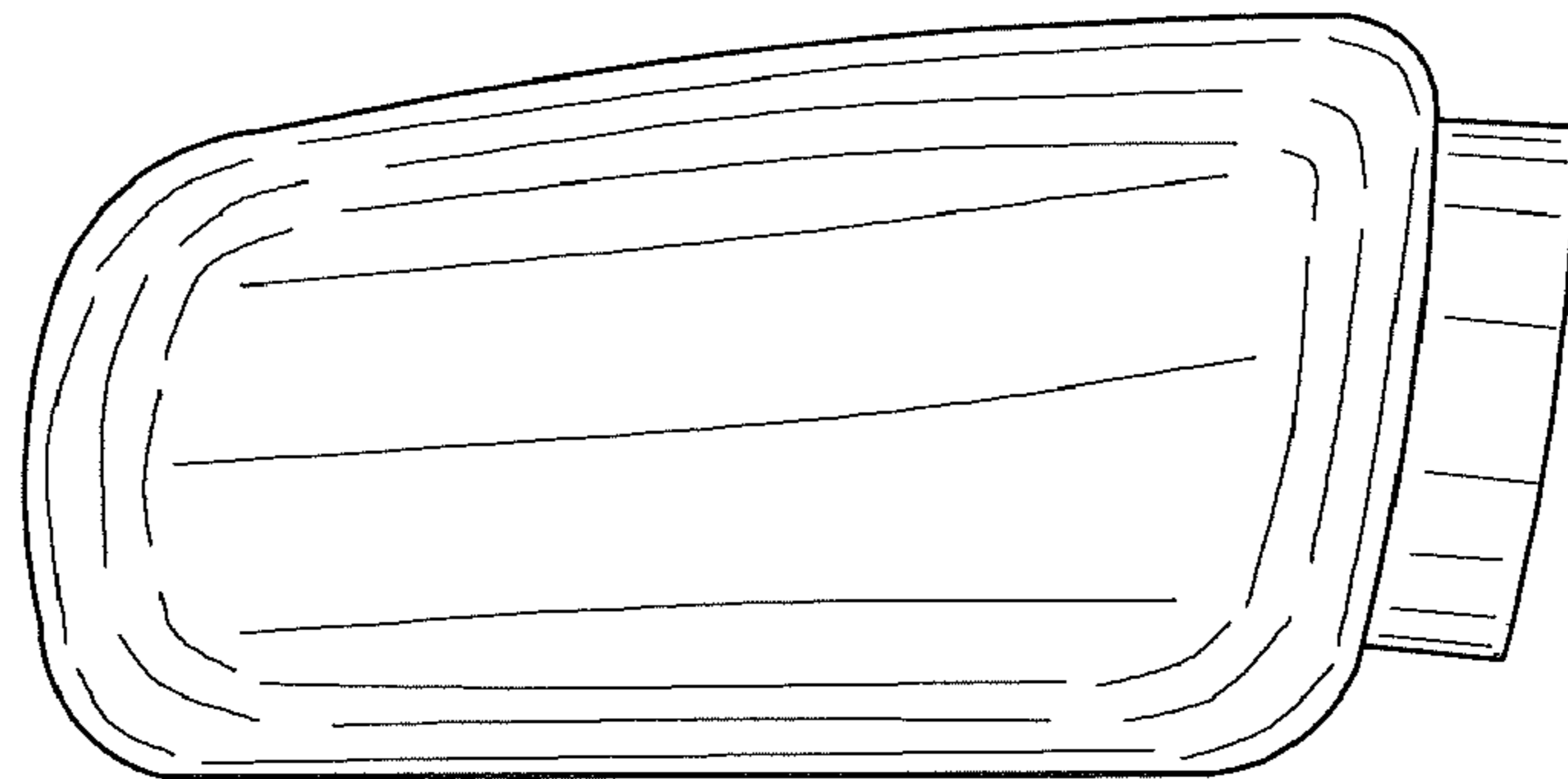

FIG. 3

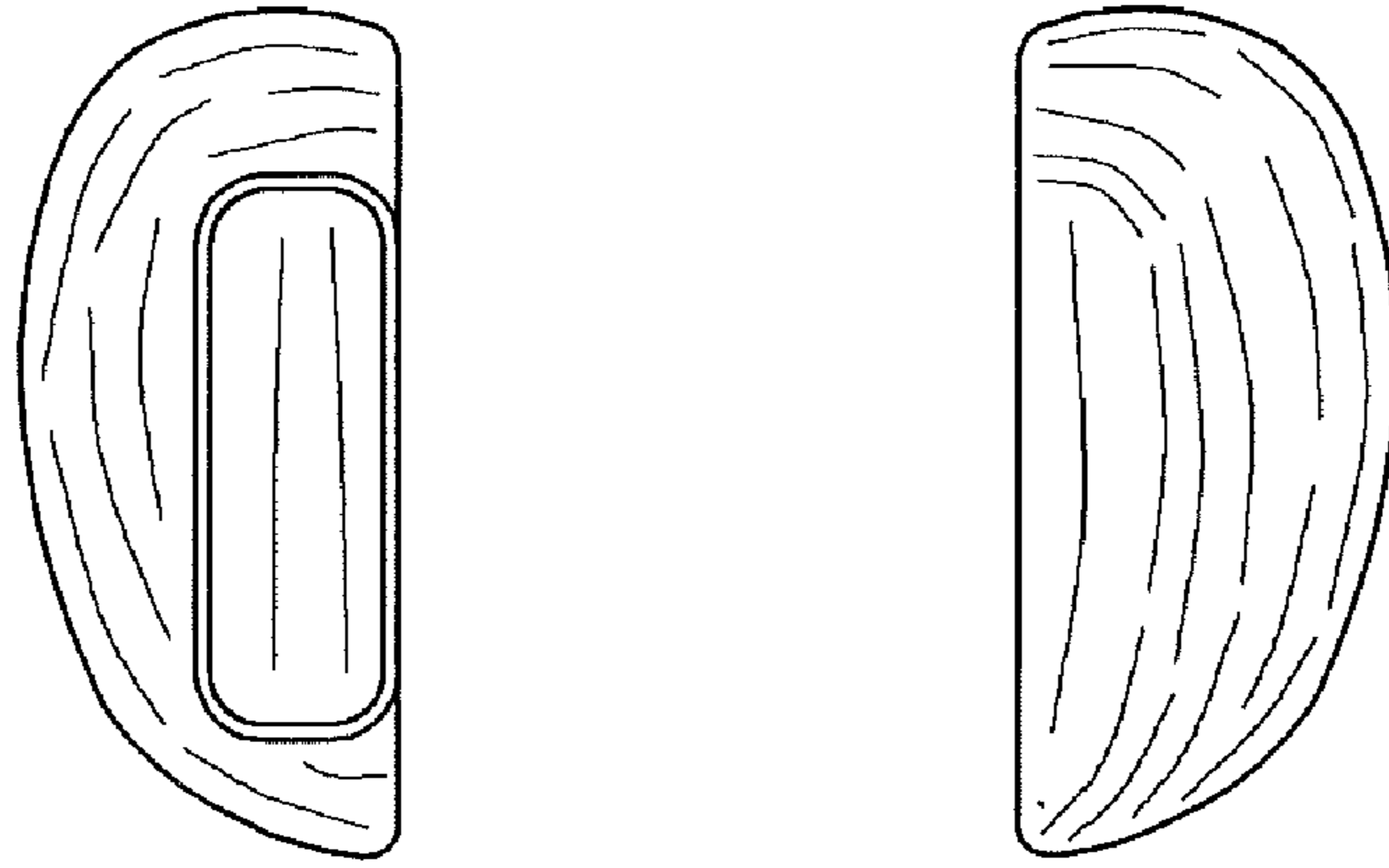

FIG. 4

FIG. 5

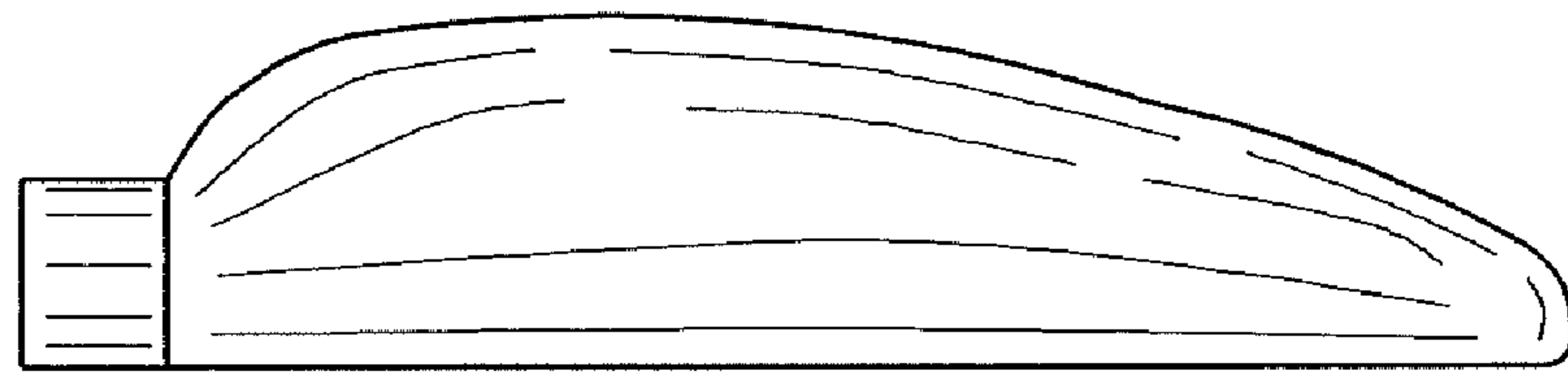

FIG. 6

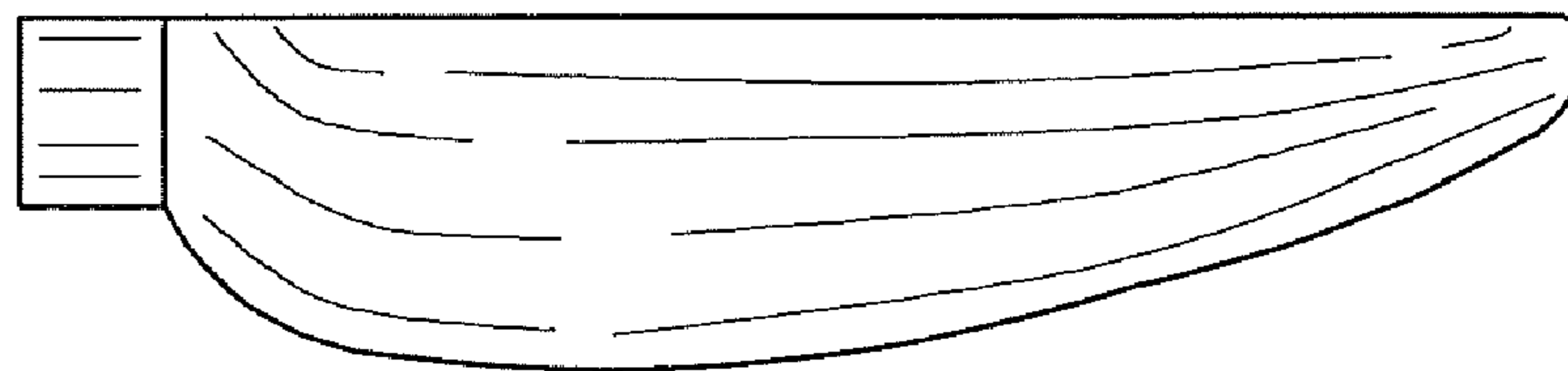

FIG. 7

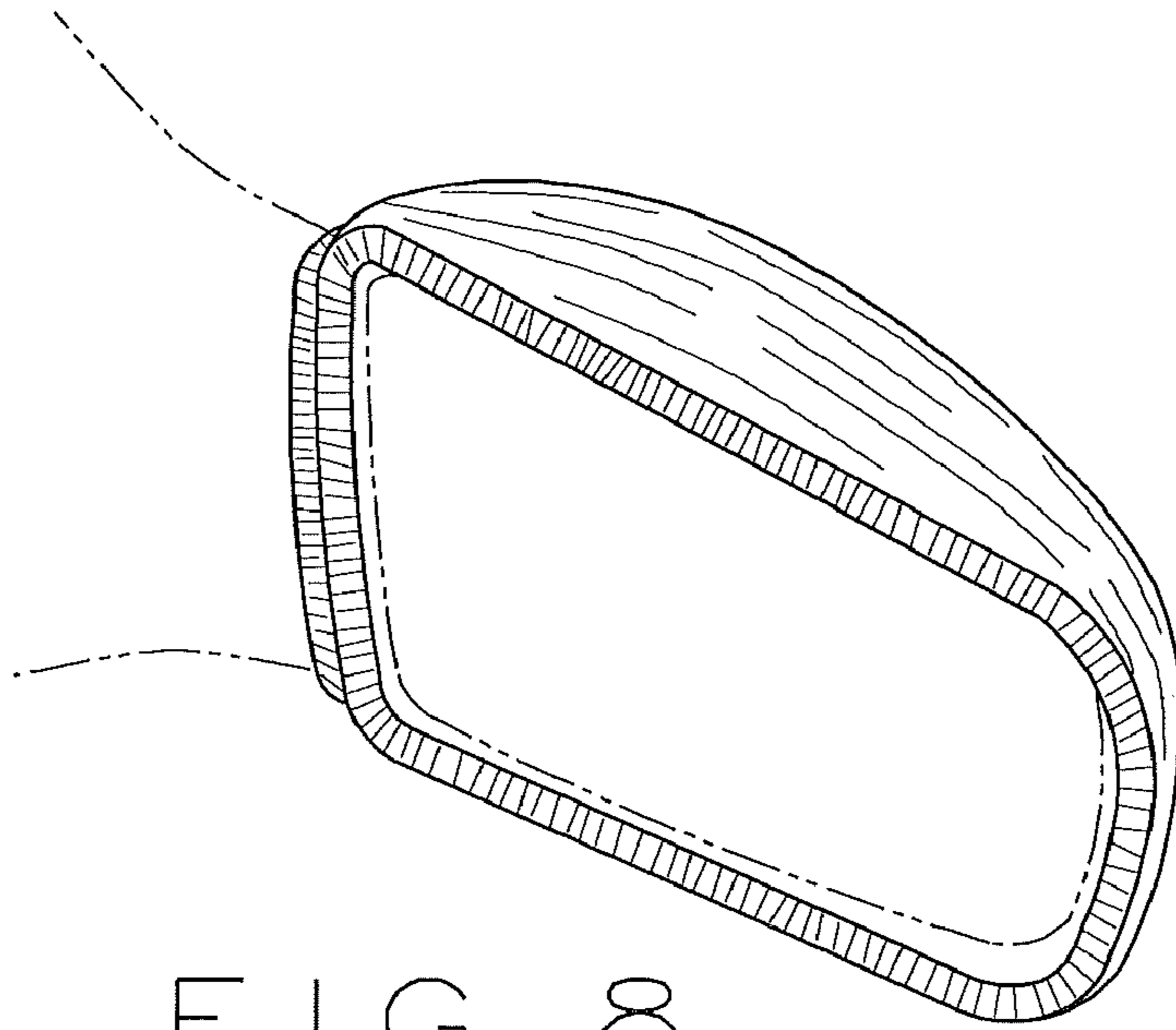

FIG. 8

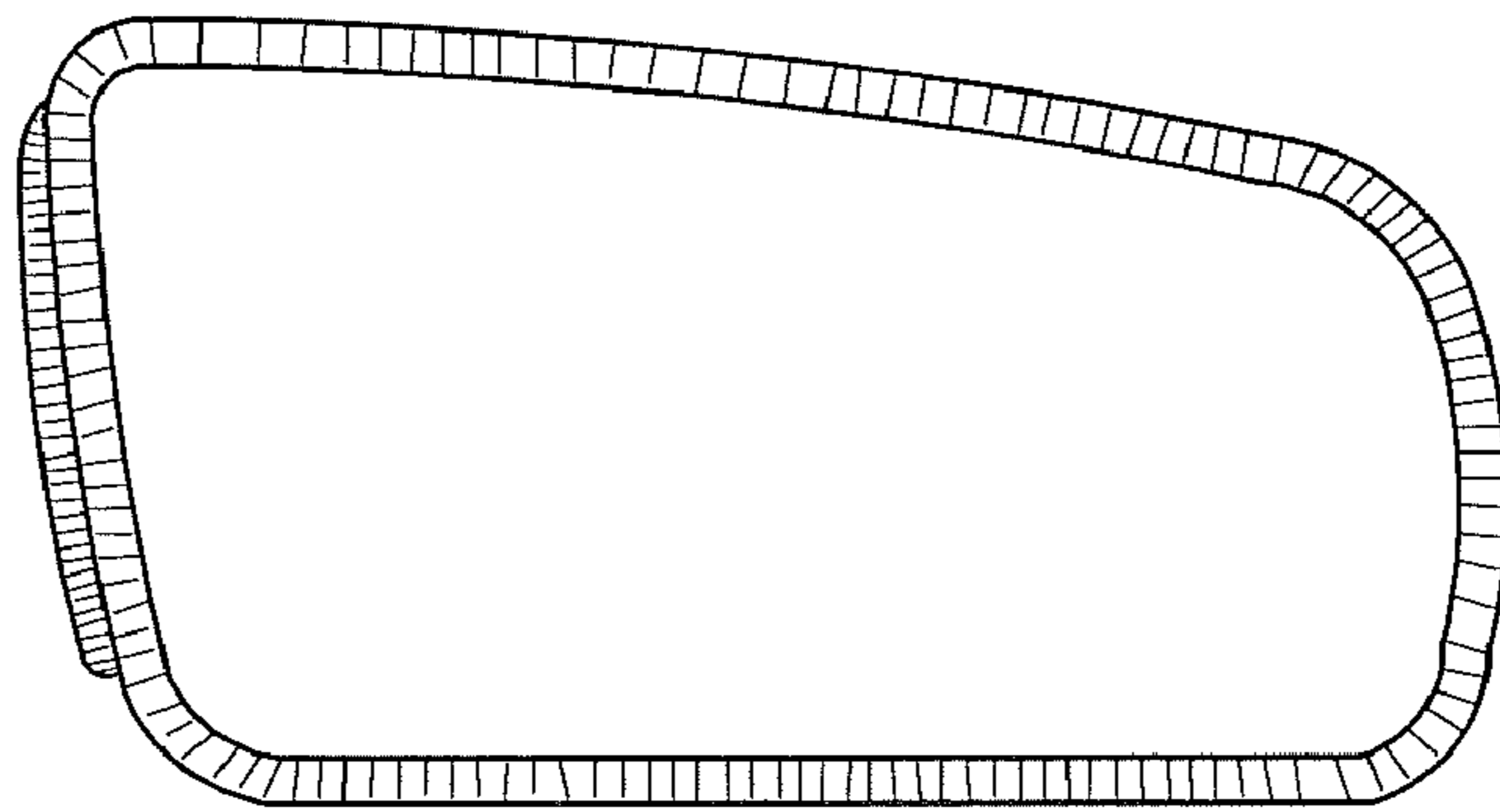

FIG. 9

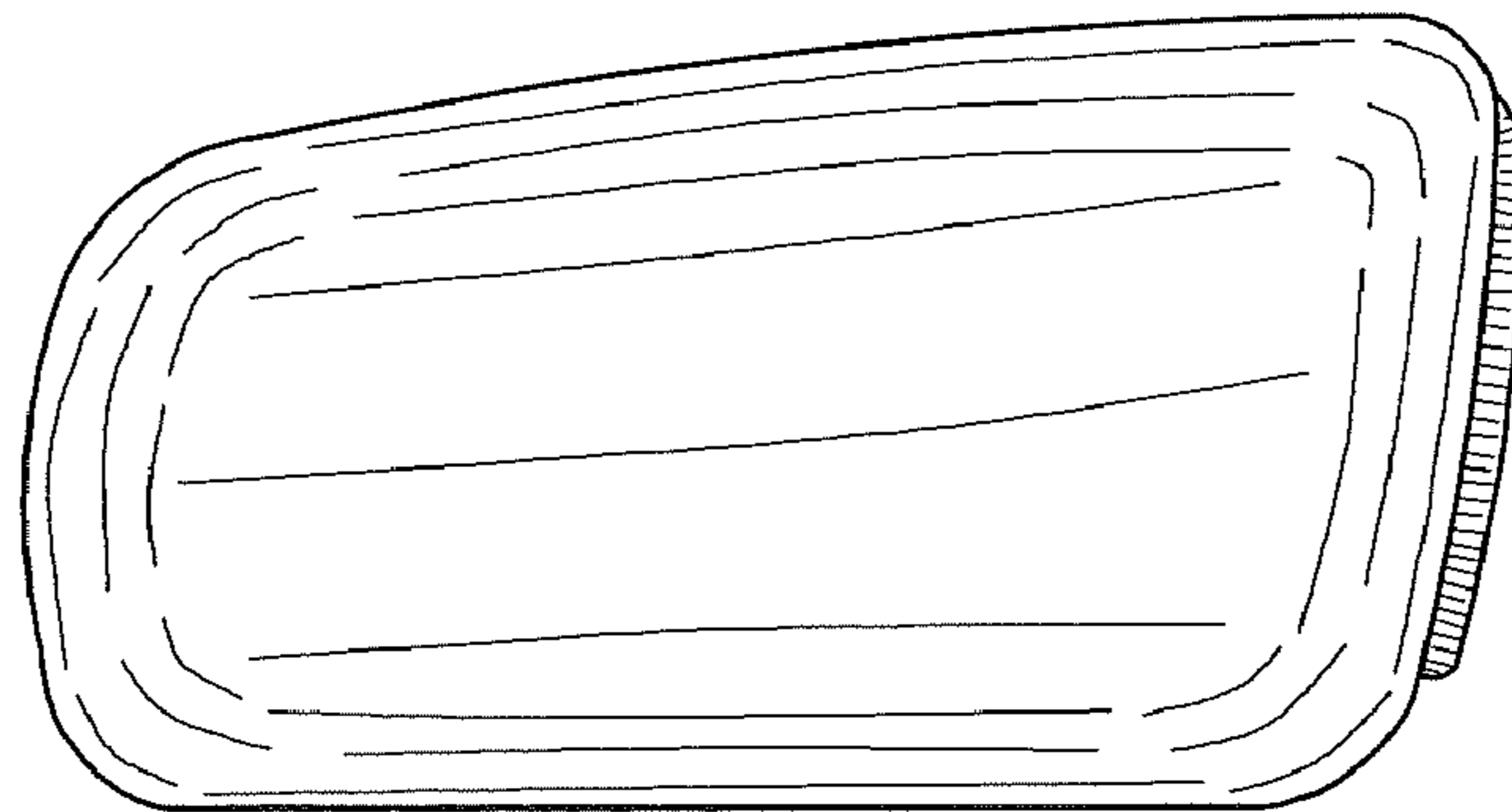

FIG. 10

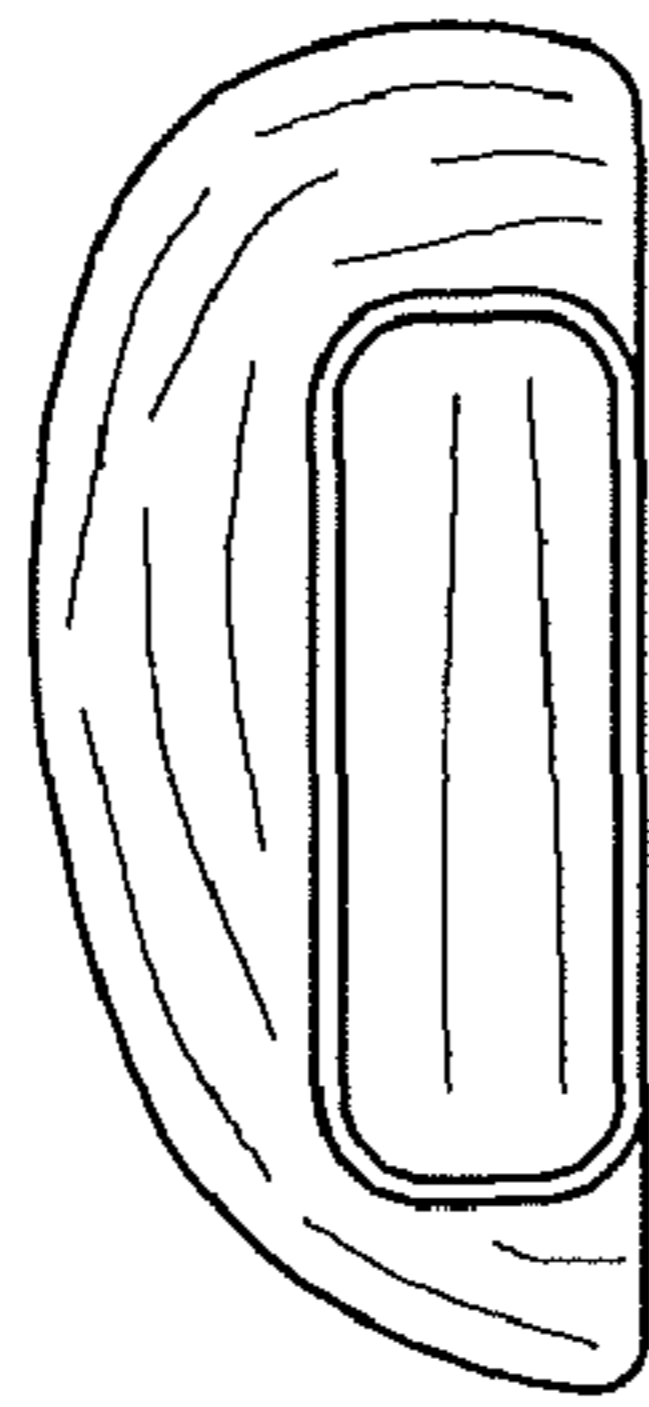

FIG. 11

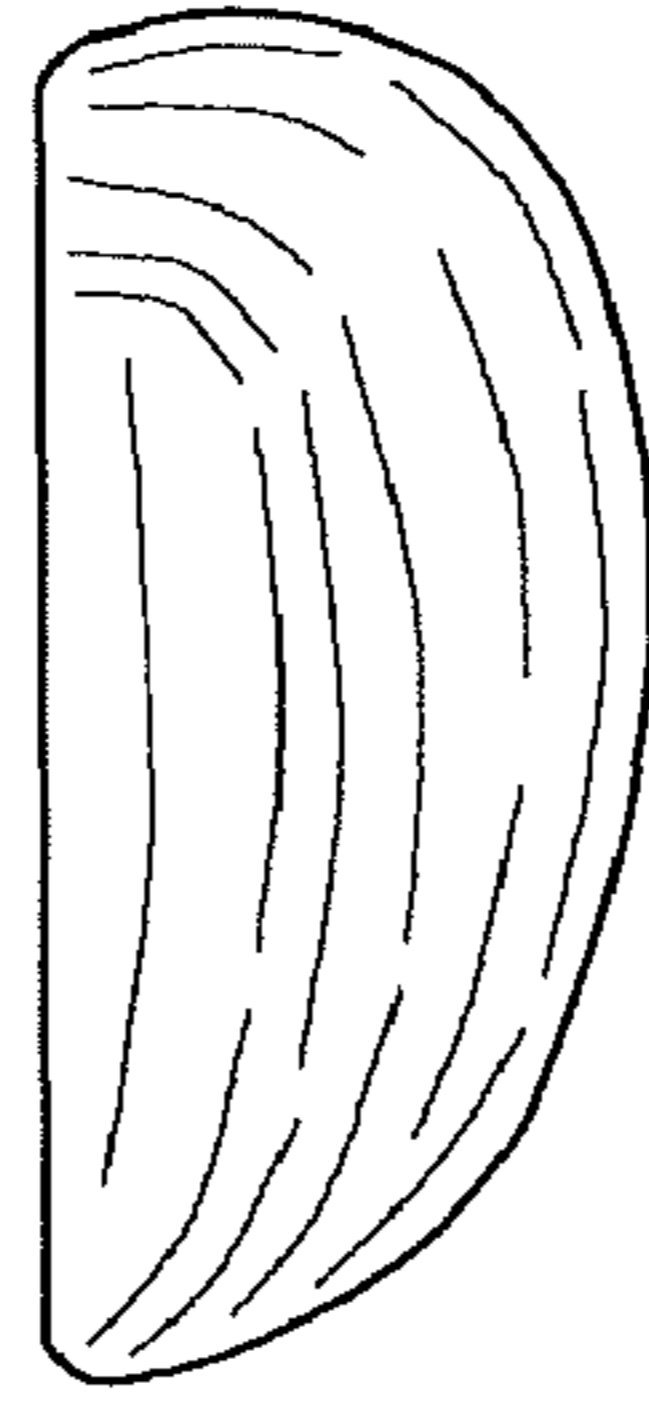

FIG. 12

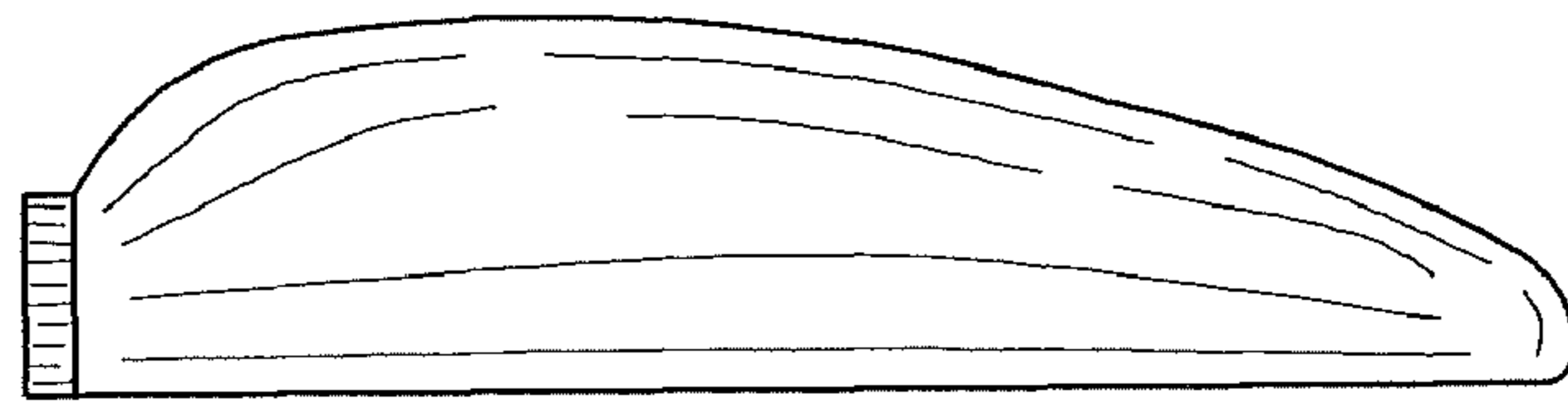

FIG. 13

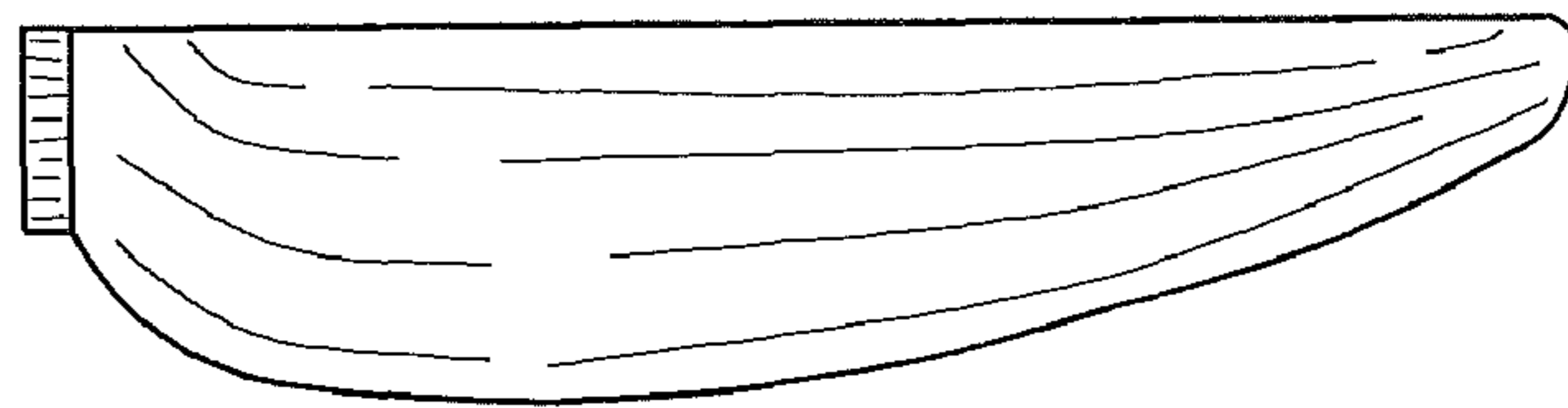

FIG. 14