



US00D636321S

(12) **United States Design Patent**
Cote

(10) **Patent No.:** **US D636,321 S**

(45) **Date of Patent:** **** Apr. 19, 2011**

(54) **PERSONAL WATERCRAFT DECK**

(75) Inventor: **Andre Cote**, Longueuil (CA)

(73) Assignee: **Bombardier Recreational Products Inc.**, Valcourt (CA)

(**) Term: **14 Years**

(21) Appl. No.: **29/352,308**

(22) Filed: **Dec. 18, 2009**

(51) **LOC (9) Cl.** **12-06**

(52) **U.S. Cl.** **D12/317**

(58) **Field of Classification Search** D12/300,
D12/307, 317; 114/55.5, 55.55, 55, 56, 7,
114/357, 380

See application file for complete search history.

(56) **References Cited**

U.S. PATENT DOCUMENTS

| | | | | |
|--------------|---------|-----------------|-------|---------|
| D343,160 S * | 1/1994 | LaPointe | | D12/307 |
| D464,015 S * | 10/2002 | Bucaccio et al. | | D12/307 |
| D550,603 S * | 9/2007 | Cote et al. | | D12/307 |

* cited by examiner

Primary Examiner — Lisa P Lichtenstein

(74) *Attorney, Agent, or Firm* — Osler, Hoskin & Harcourt LLP

(57) **CLAIM**

The ornamental design for a personal watercraft deck, as shown and described.

DESCRIPTION

FIG. 1 is a perspective view, taken from a top, front, left side, showing a personal watercraft deck according to my design; FIG. 2 is a rear elevation view thereof; FIG. 3 is a right side elevation view thereof; FIG. 4 is a left side elevation view thereof; FIG. 5 is a top plan view thereof; FIG. 6 is a perspective view thereof, taken from a top, rear, left side; FIG. 7 is a perspective view thereof, taken from a top, left side; FIG. 8 is a cross-sectional view thereof, as seen from line 8—8 in FIG. 6; and, FIG. 9 is a cross-sectional view thereof, as seen from line 9—9 in FIG. 6.

Throughout the figures, the dashed broken lines show unclaimed structure of the personal watercraft, and form no part of the claimed design. The dash-dot broken lines represent the boundary between claimed and unclaimed areas and form no part of the claimed design.

1 Claim, 9 Drawing Sheets

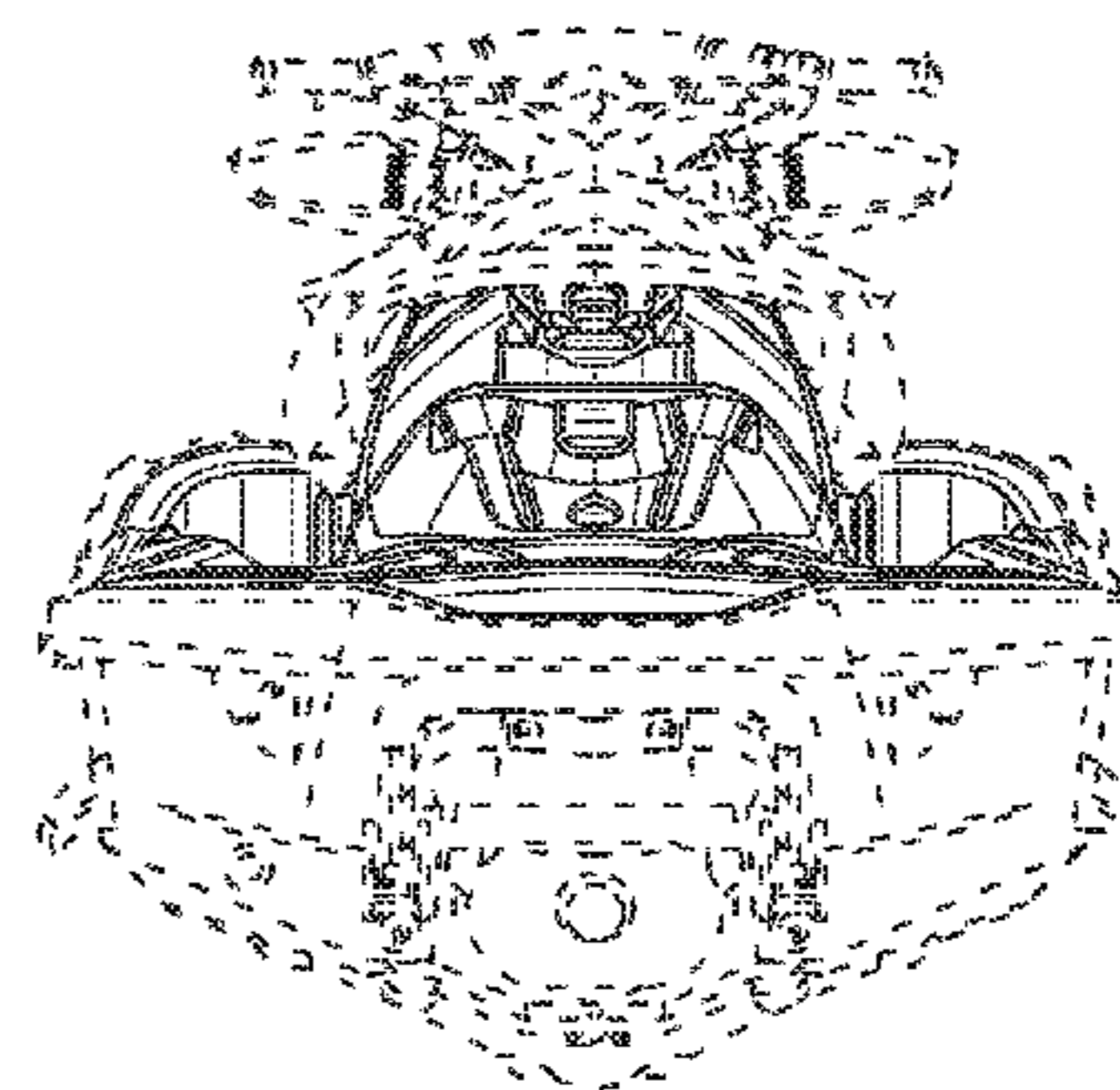
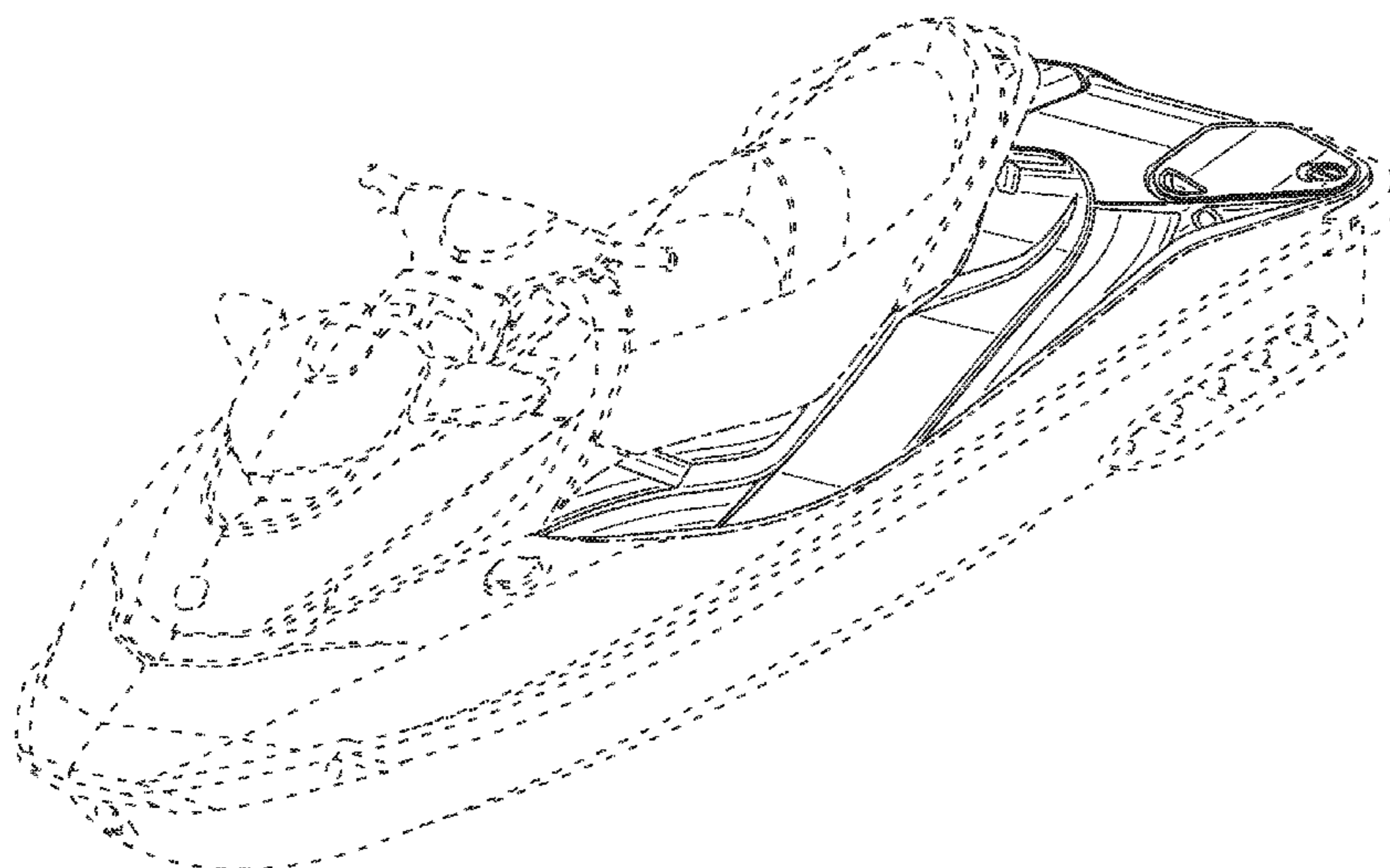

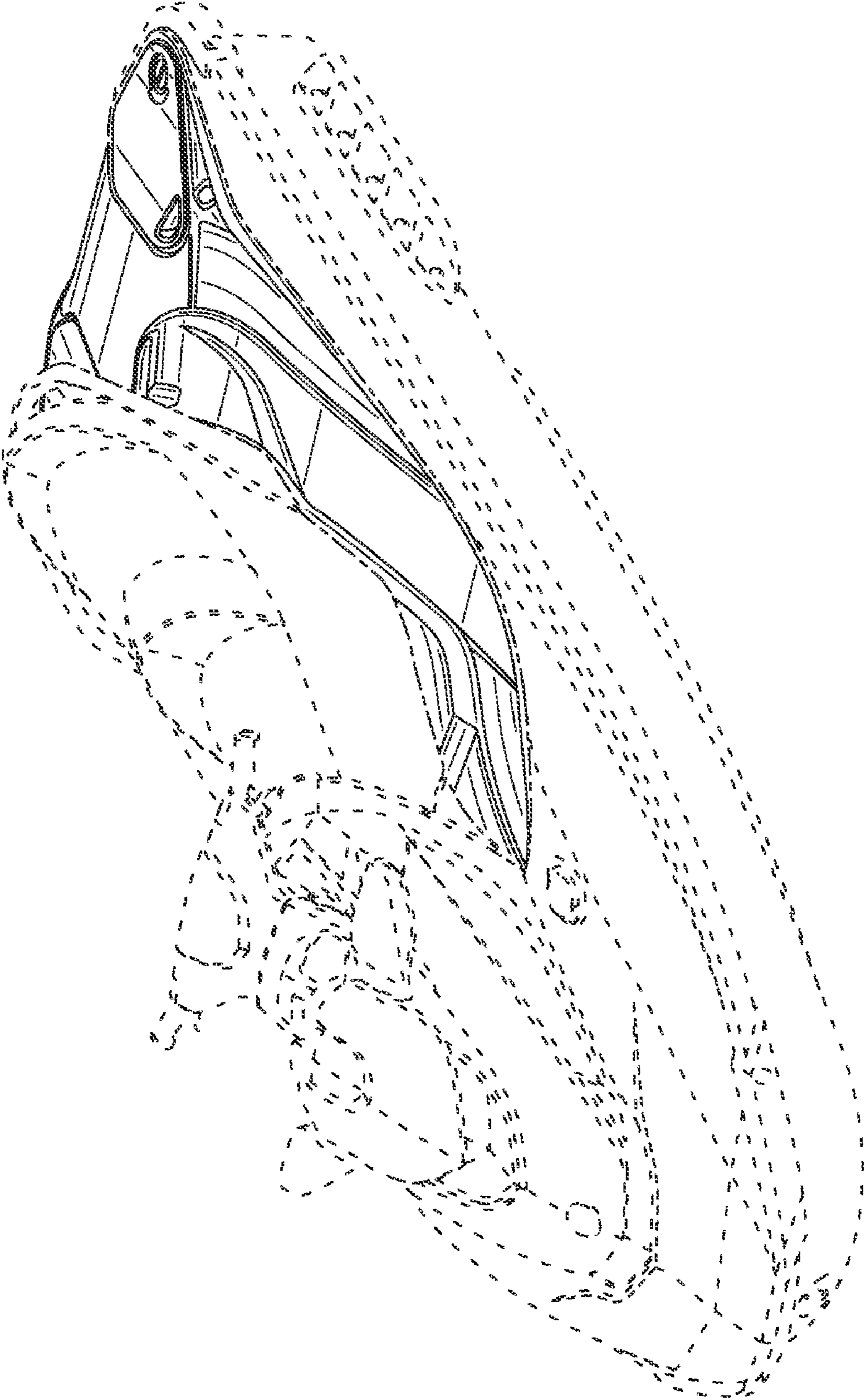

FIG. 1

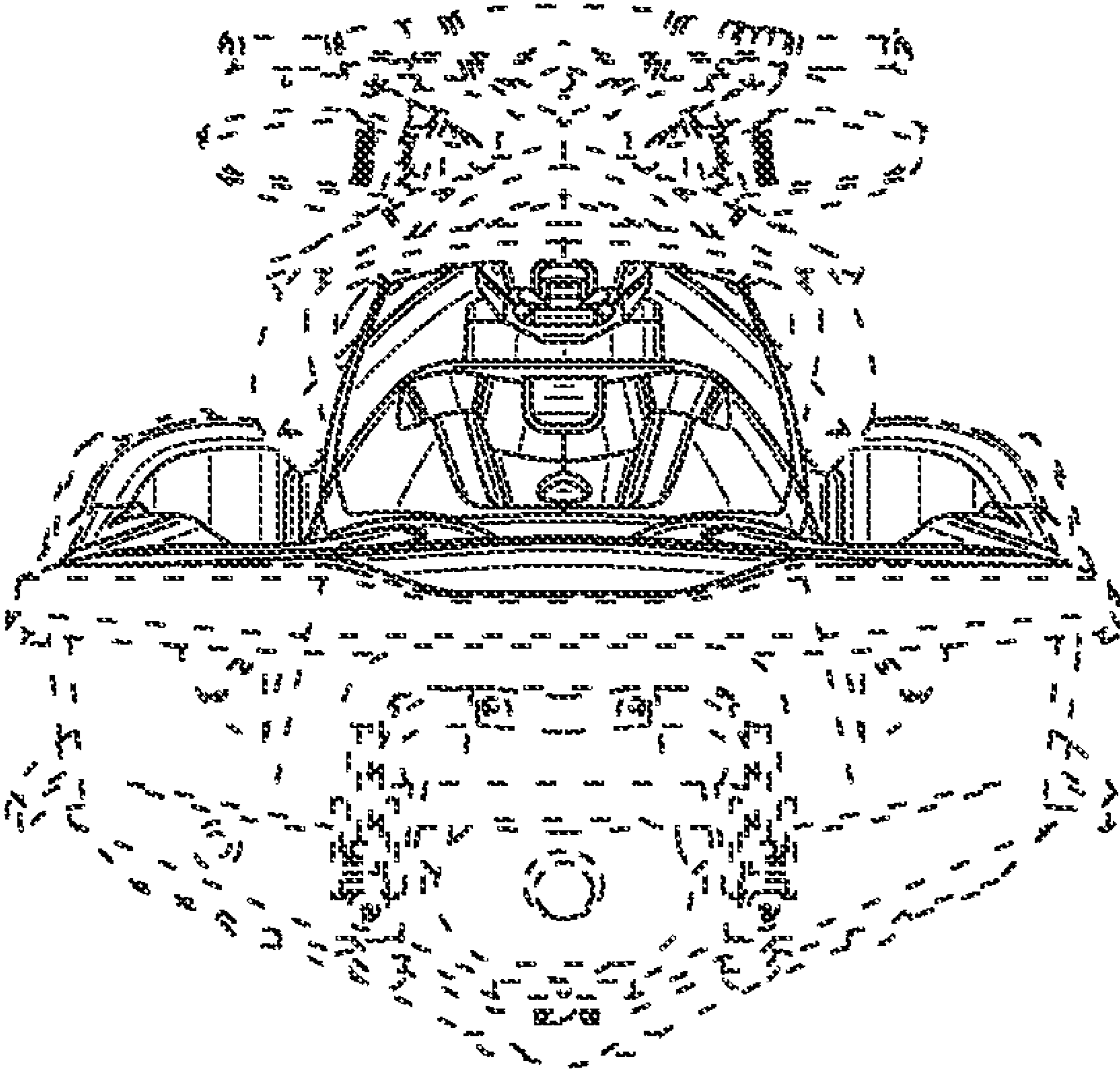

FIG. 2

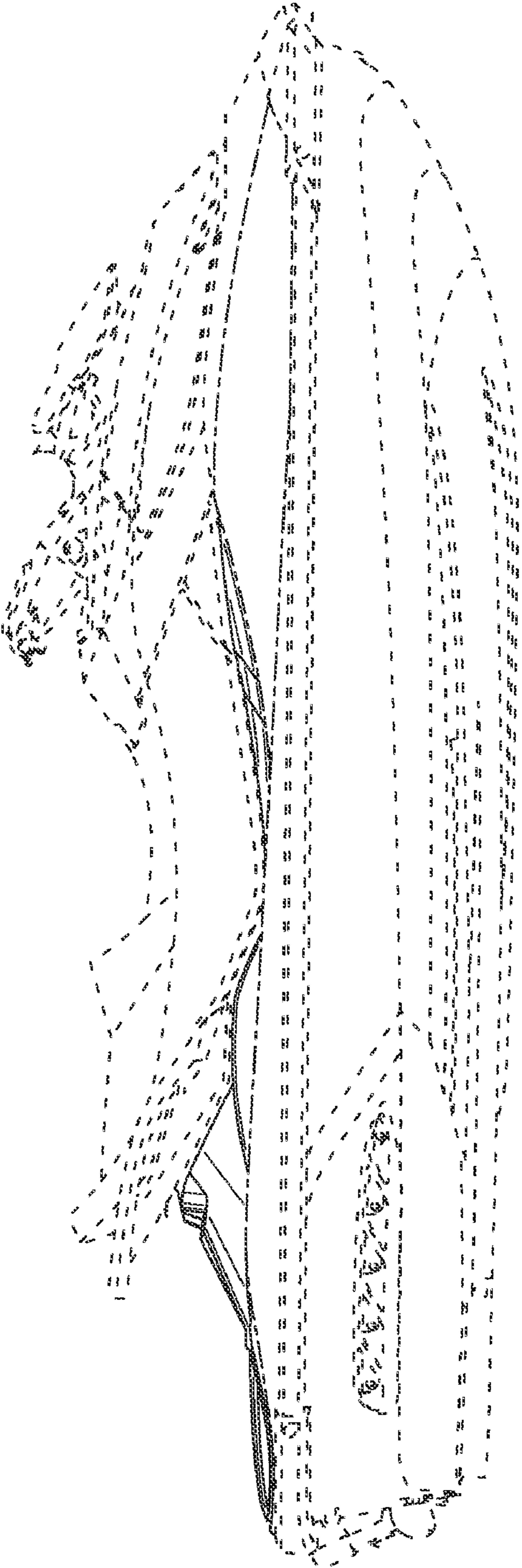

FIG. 3

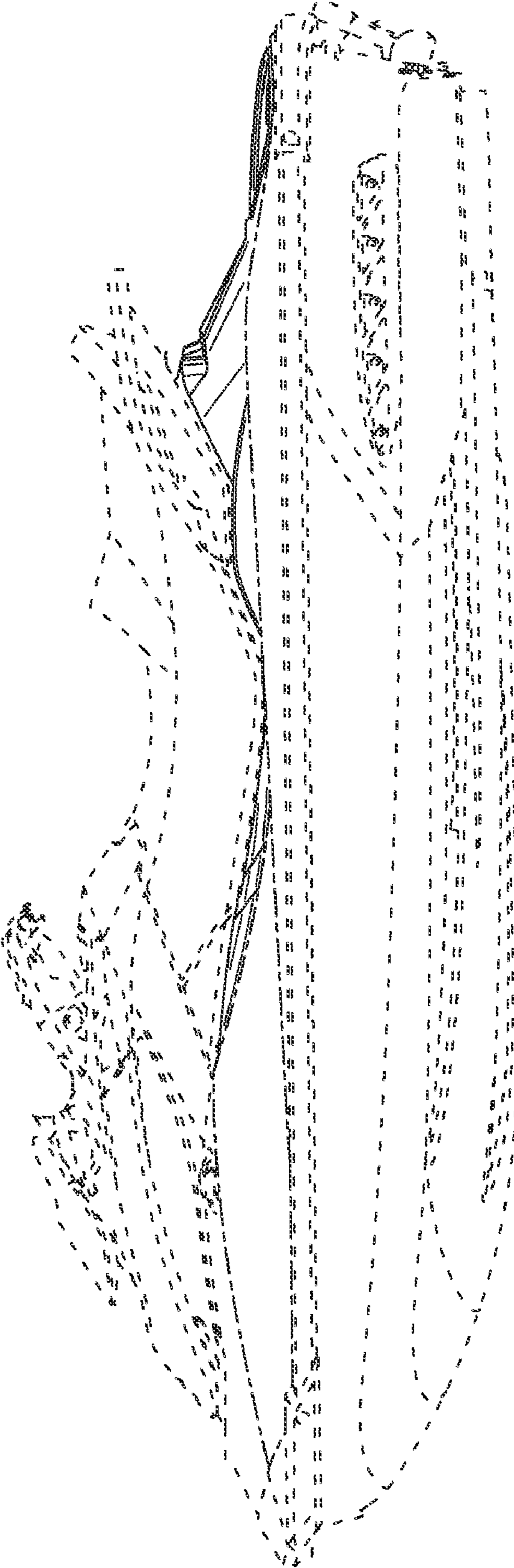

FIG. 4

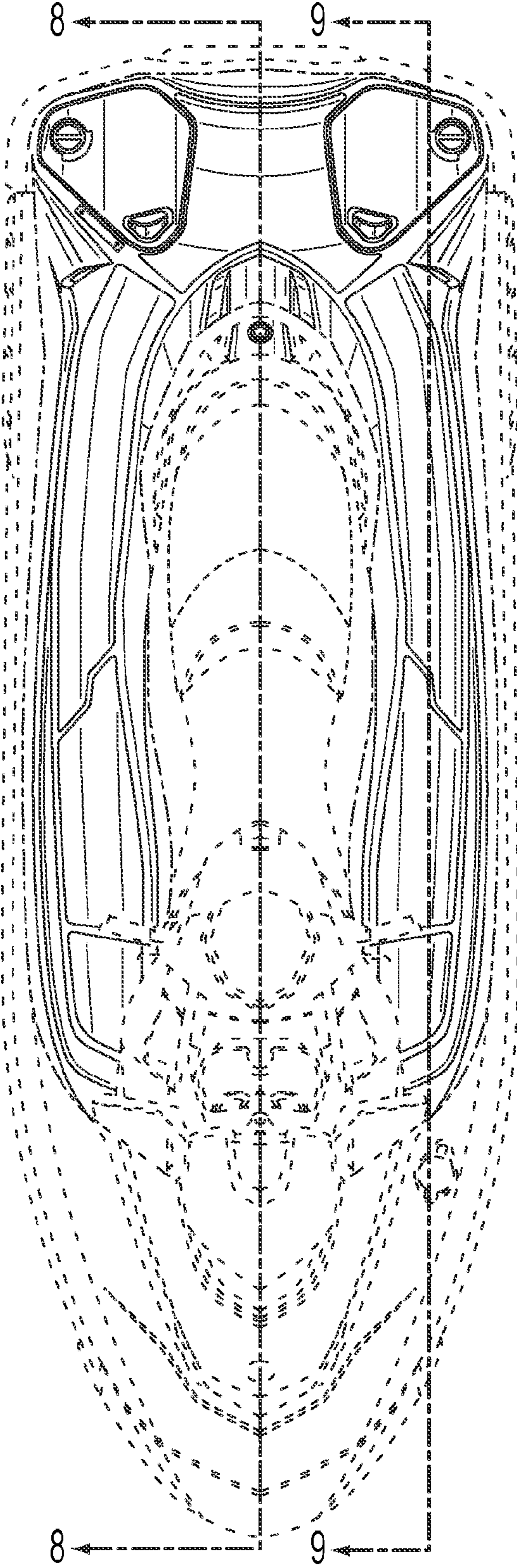

FIG. 5

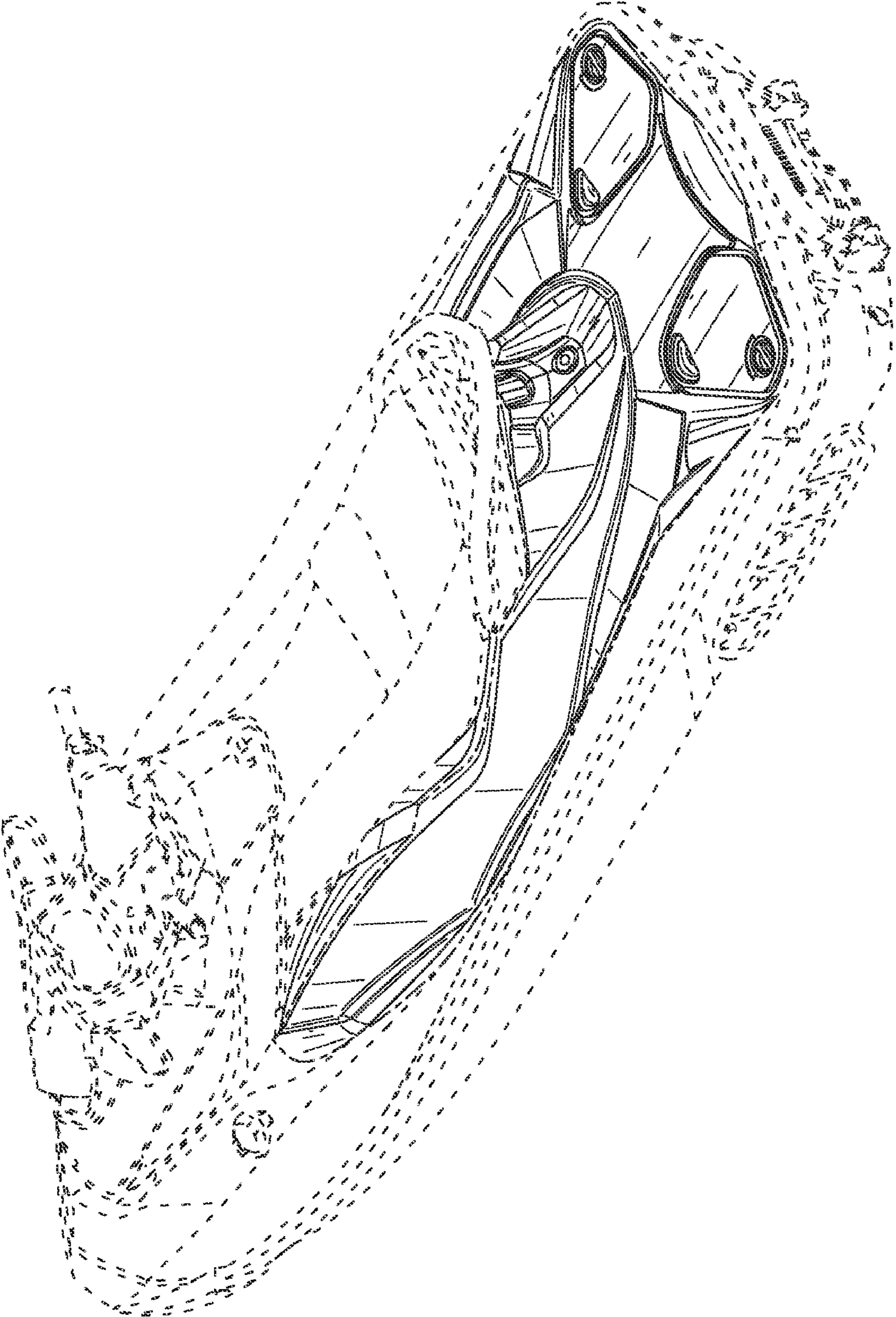

FIG. 6

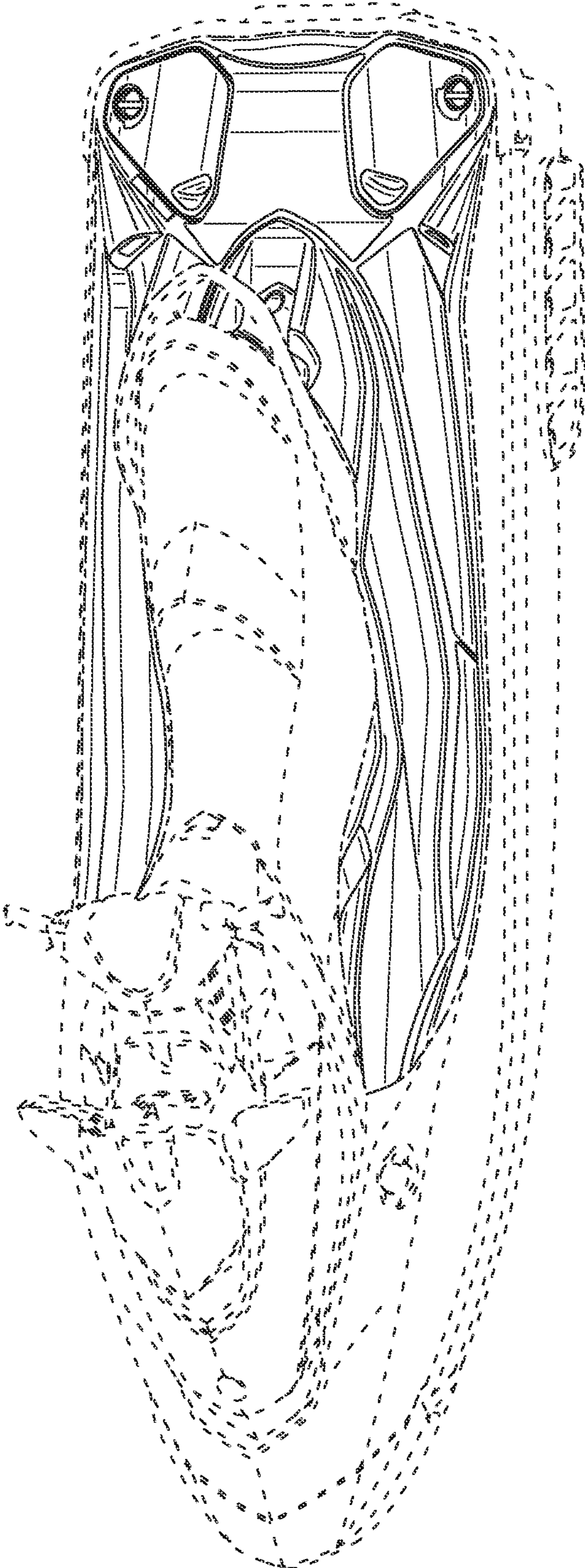

FIG. 7

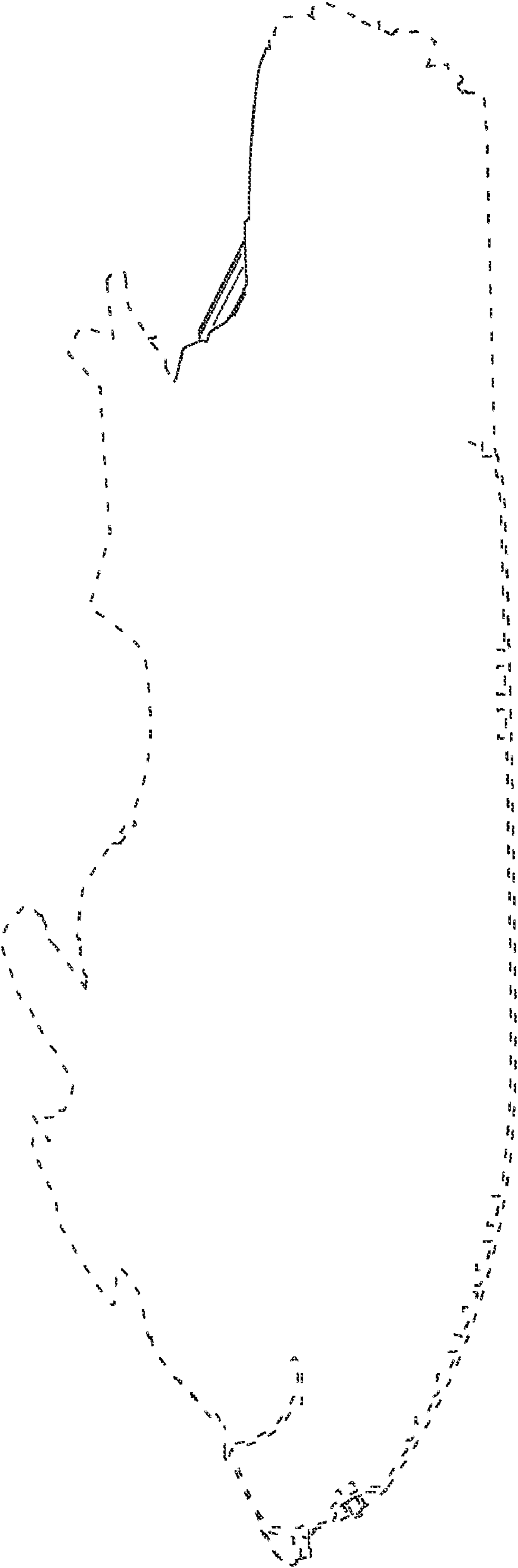

FIG. 8

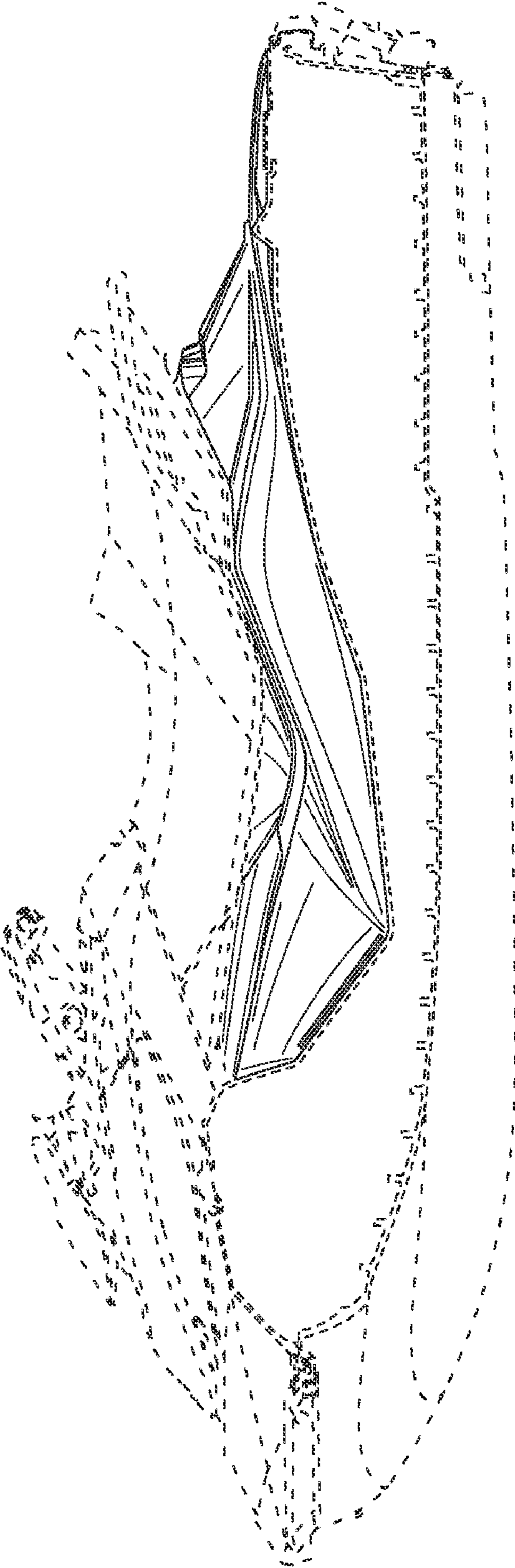

FIG. 9

UNITED STATES PATENT AND TRADEMARK OFFICE
CERTIFICATE OF CORRECTION

PATENT NO. : D636,321 S
APPLICATION NO. : 29/352308
DATED : April 19, 2011
INVENTOR(S) : Andre Cote

Page 1 of 11

It is certified that error appears in the above-identified patent and that said Letters Patent is hereby corrected as shown below:

The title page showing the illustrative figure should be deleted and replaced with the attached title page.

On the Title page: under Description;

The description for FIG. 8 should read: FIG. 8 is a cross-sectional view thereof, as seen from line 8-8 in FIG. --5--; and,

The description for FIG. 9 should read: FIG. 9 is a cross-sectional view thereof, as seen from line 9-9 in FIG. --5--.

Delete the drawings which are in the issued patent and substitute them with the attached drawings.

Signed and Sealed this
Seventeenth Day of July, 2012

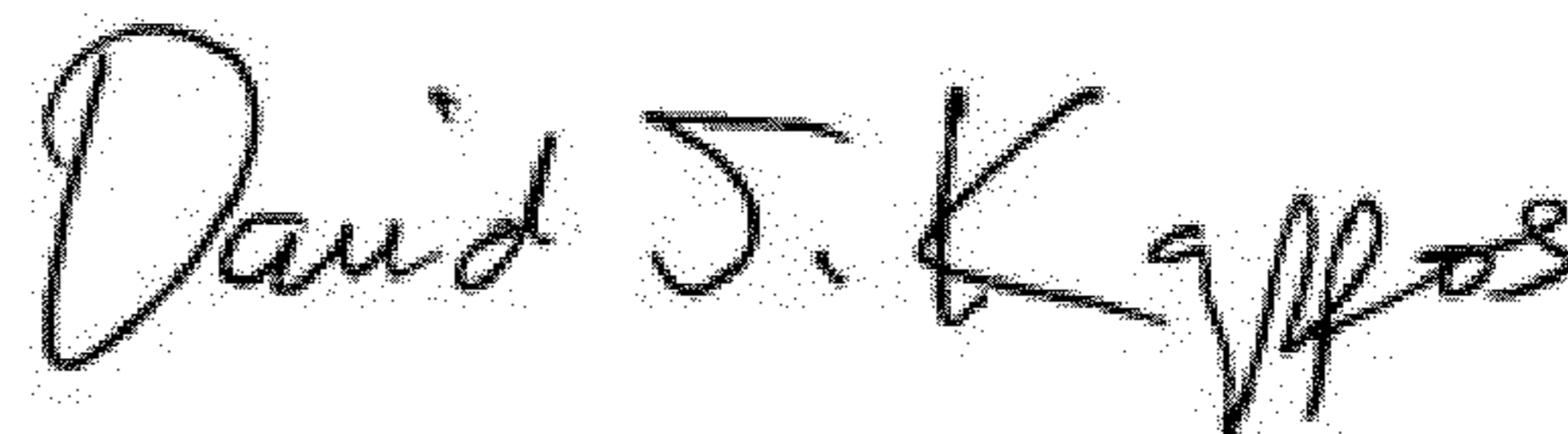

David J. Kappos
Director of the United States Patent and Trademark Office

(12) **United States Design Patent** (10) **Patent No.:** **US D636,321 S**
 Cote (45) **Date of Patent:** **** Apr. 19, 2011**

(54) **PERSONAL WATERCRAFT DECK**

(75) **Inventor:** Andre Cote, Longueuil (CA)

(73) **Assignee:** **Bombardier Recreational Products Inc., Valcourt (CA)**

(**) **Term:** **14 Years**

(21) **Appl. No.:** **29/352,308**

(22) **Filed:** **Dec. 18, 2009**

(51) **LOC (9) Cl.** **12-06**

(52) **U.S. Cl.** **D12/317**

(58) **Field of Classification Search** **D12/300,**
D12/307, 317; 114/55.5, 55.55, 55, 56, 7,
114/357, 380

See application file for complete search history.

(56) **References Cited**

U.S. PATENT DOCUMENTS

D343,160 S * 1/1994 LaPointe D12/307
 D464,015 S * 10/2002 Bucaccio et al. D12/307
 D550,603 S * 9/2007 Cote et al. D12/307

* cited by examiner

Primary Examiner -- Lisa P Lichtenstein

(74) *Attorney, Agent, or Firm* -- Osler, Hoskin & Harcourt LLP

(57) **CLAIM**

The ornamental design for a personal watercraft deck, as shown and described.

DESCRIPTION

FIG. 1 is a perspective view, taken from a top, front, left side, showing a personal watercraft deck according to my design; FIG. 2 is a rear elevation view thereof; FIG. 3 is a right side elevation view thereof; FIG. 4 is a left side elevation view thereof; FIG. 5 is a top plan view thereof; FIG. 6 is a perspective view thereof, taken from a top, rear, left side; FIG. 7 is a perspective view thereof, taken from a top, left side; FIG. 8 is a cross-sectional view thereof, as seen from line 8—8 in FIG. 6; and, FIG. 9 is a cross-sectional view thereof, as seen from line 9—9 in FIG. 6.

Throughout the figures, the dashed broken lines show unclaimed structure of the personal watercraft, and form no part of the claimed design. The dash-dot broken lines represent the boundary between claimed and unclaimed areas and form no part of the claimed design.

1 Claim, 9 Drawing Sheets

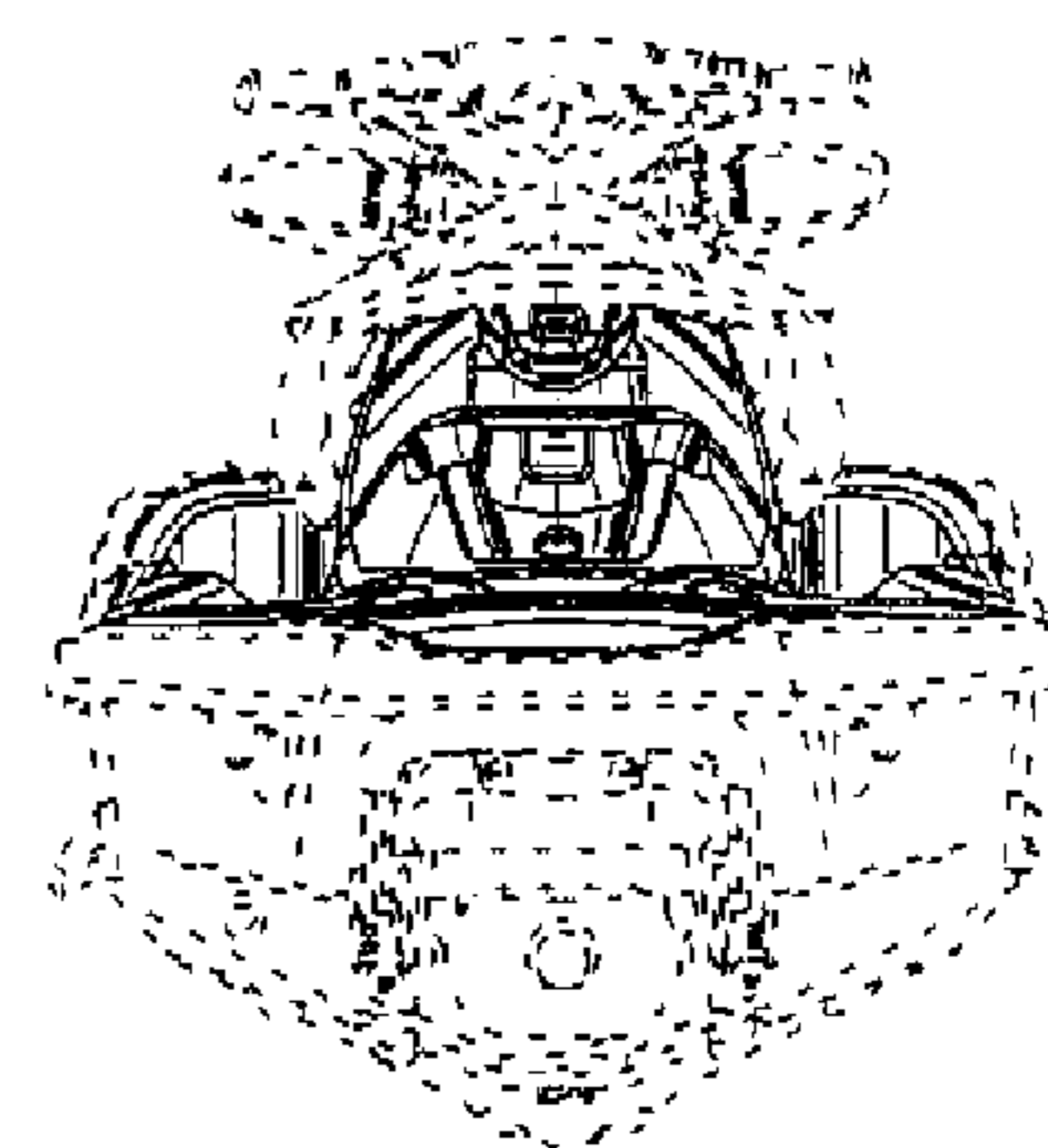
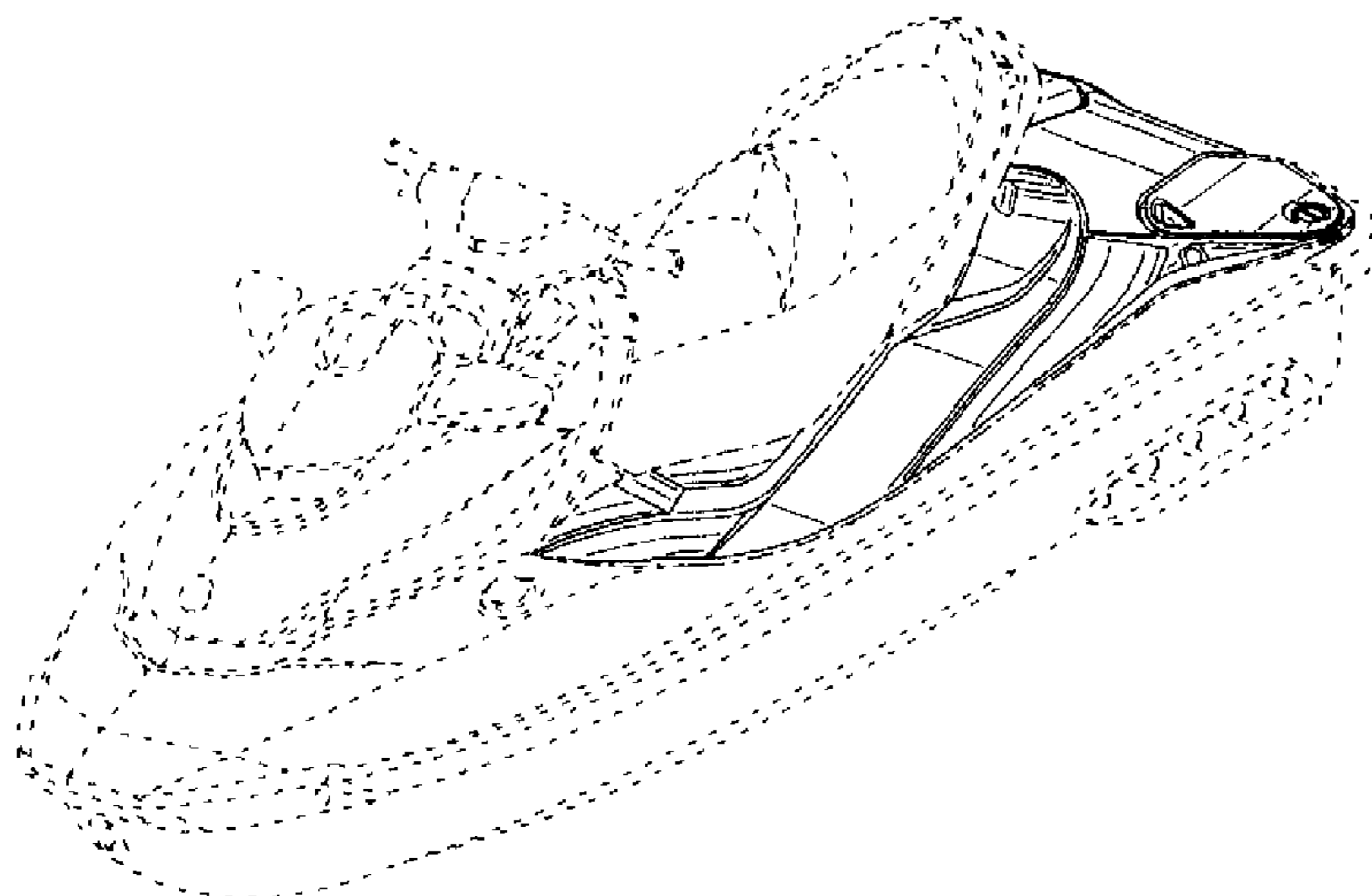

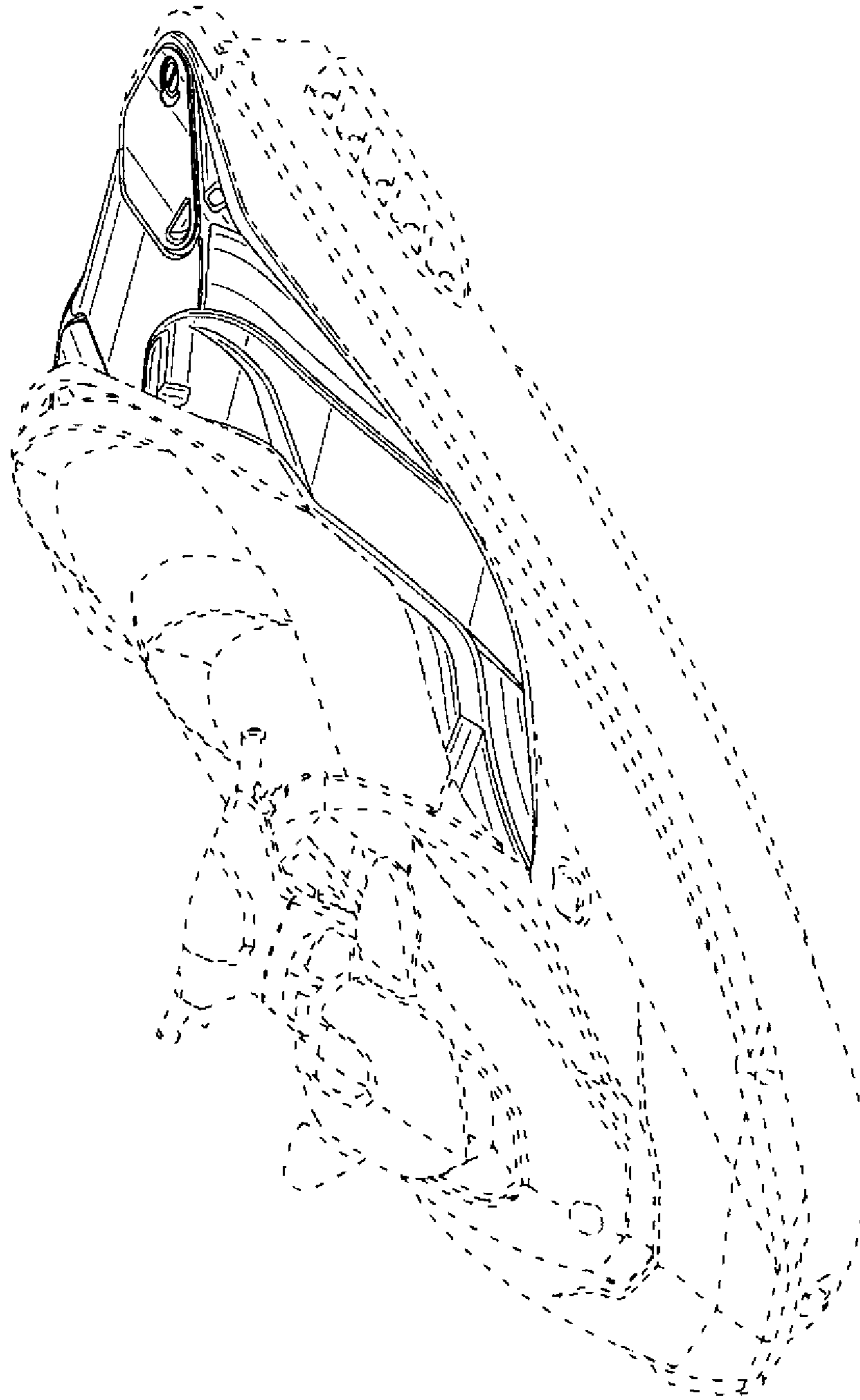

FIG. 1

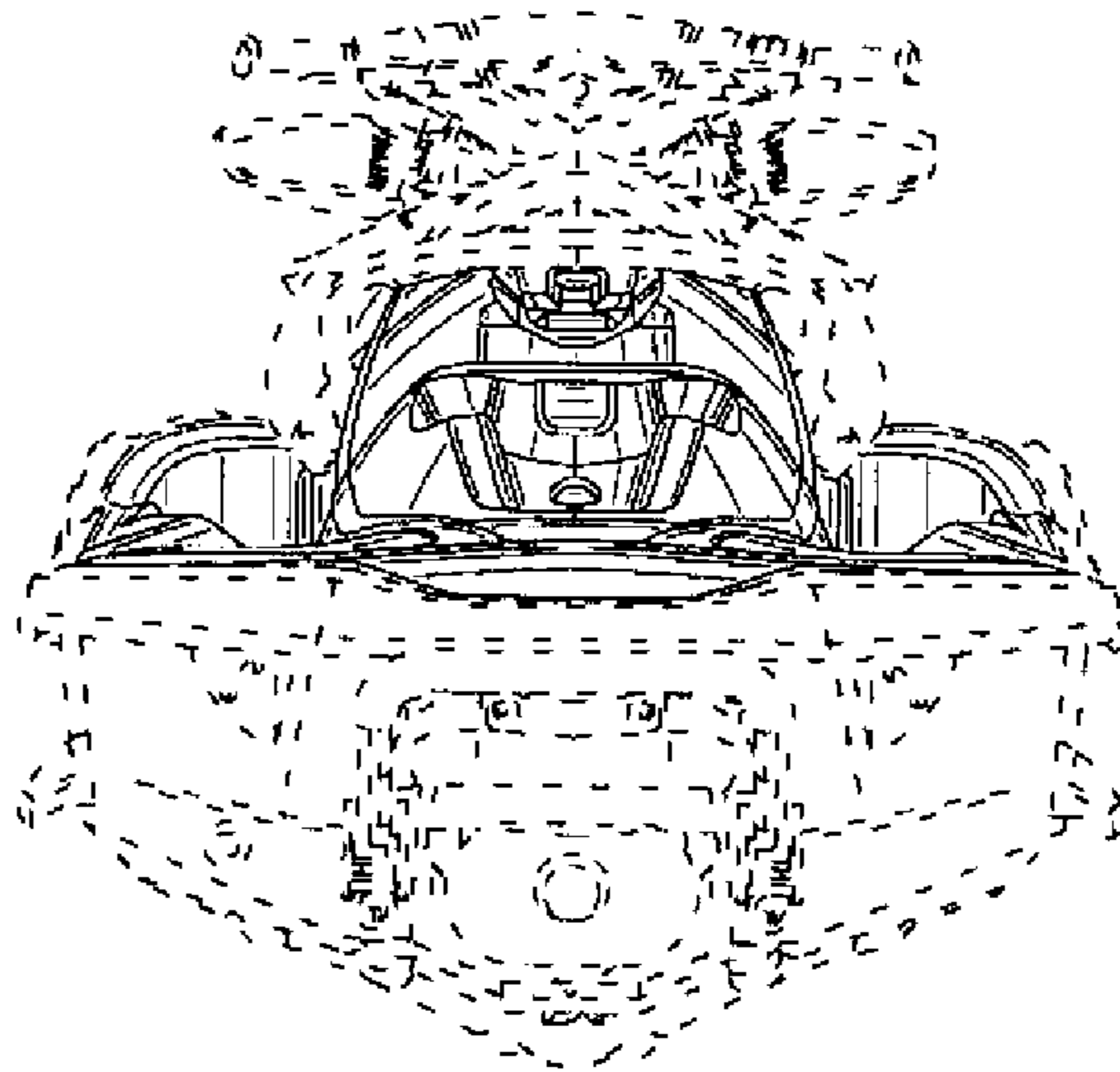

FIG. 2

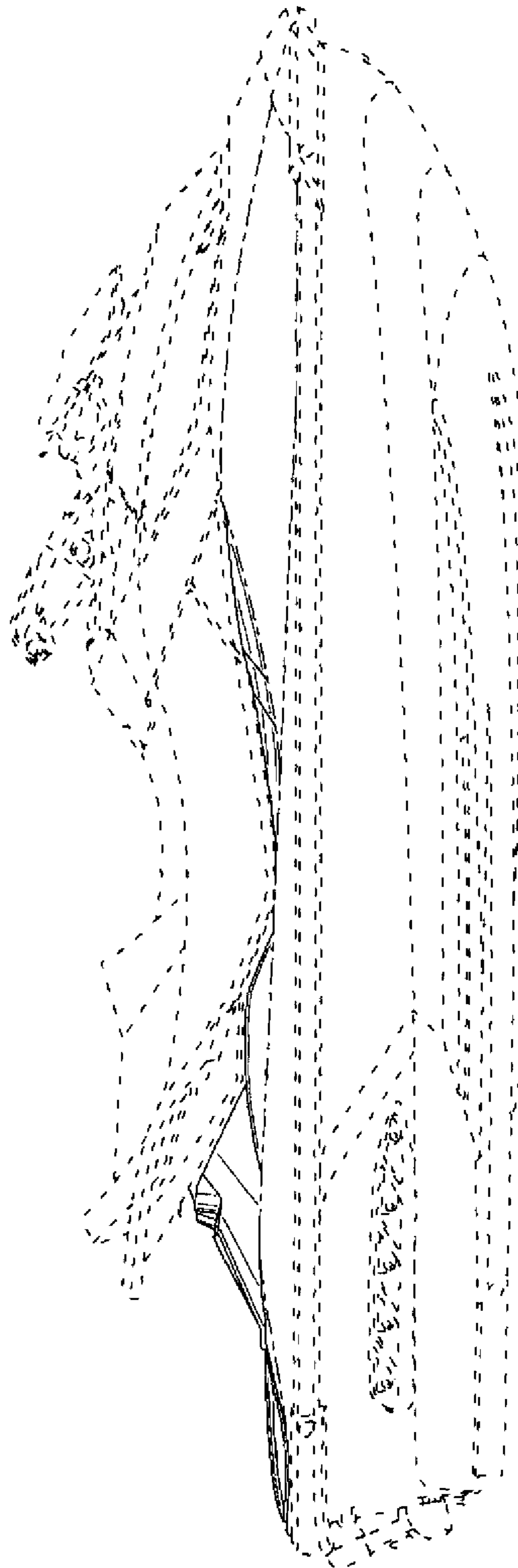

FIG. 3

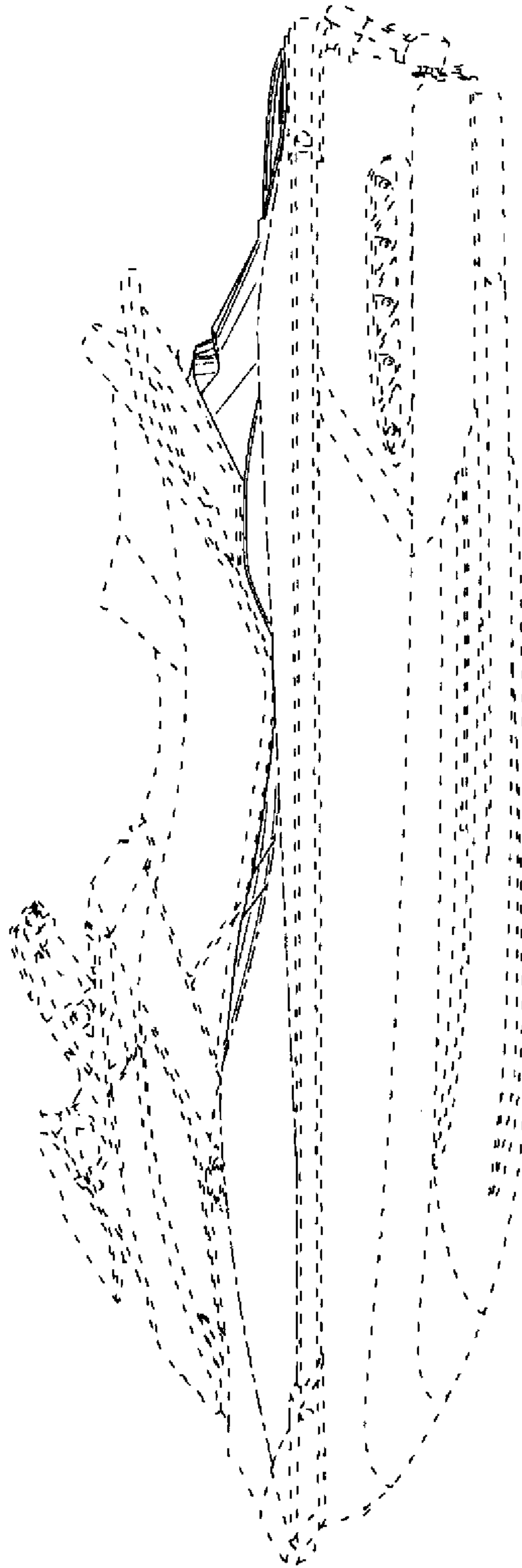

FIG. 4

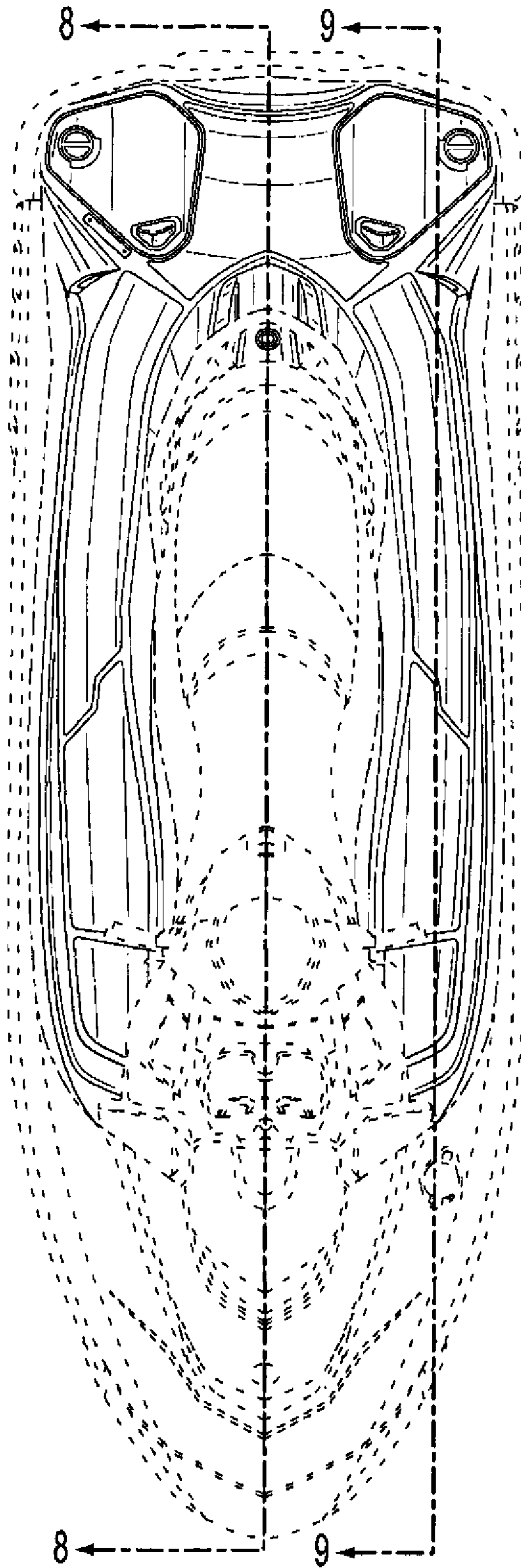

FIG. 5

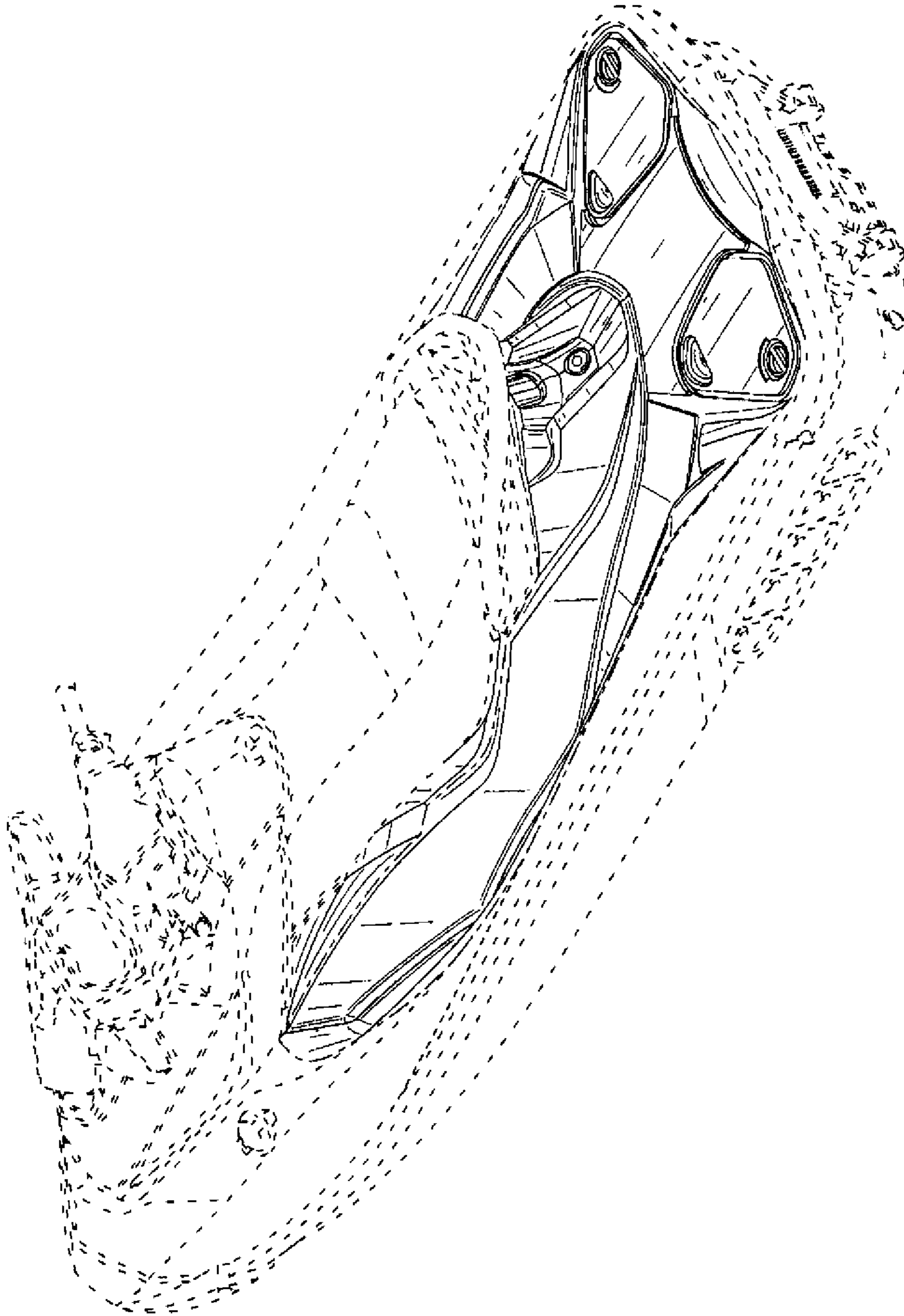

FIG. 6

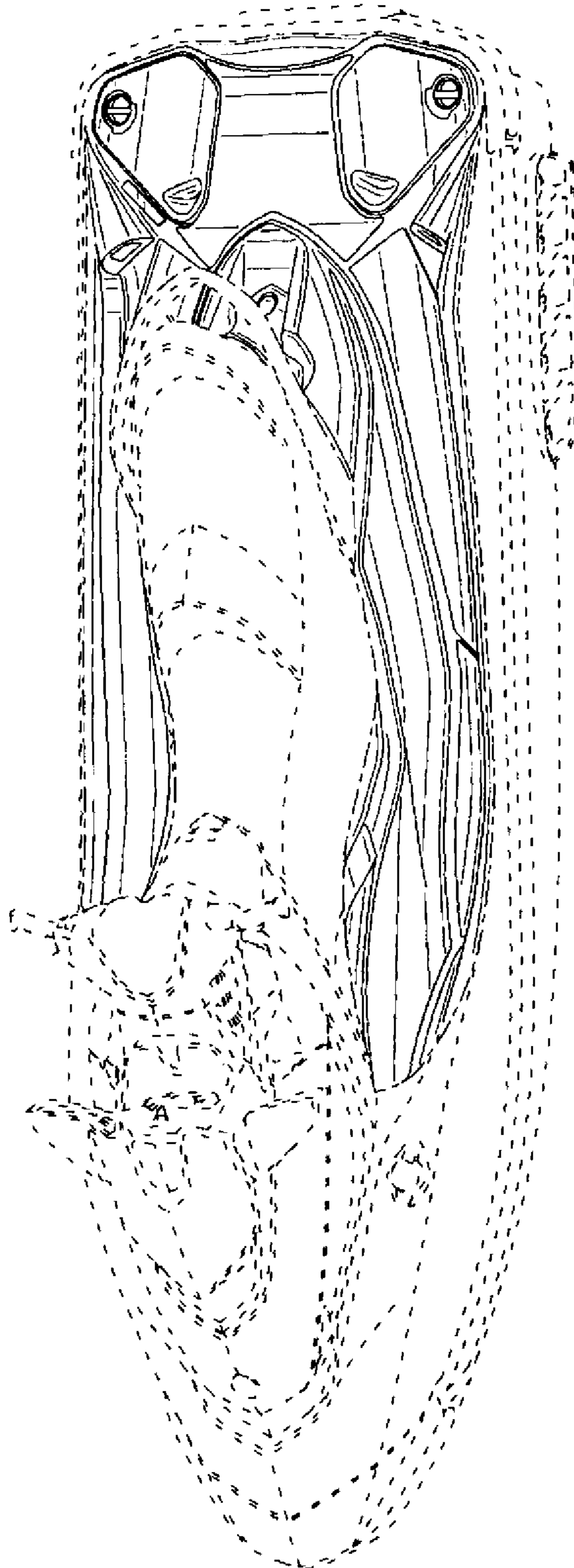

FIG. 7

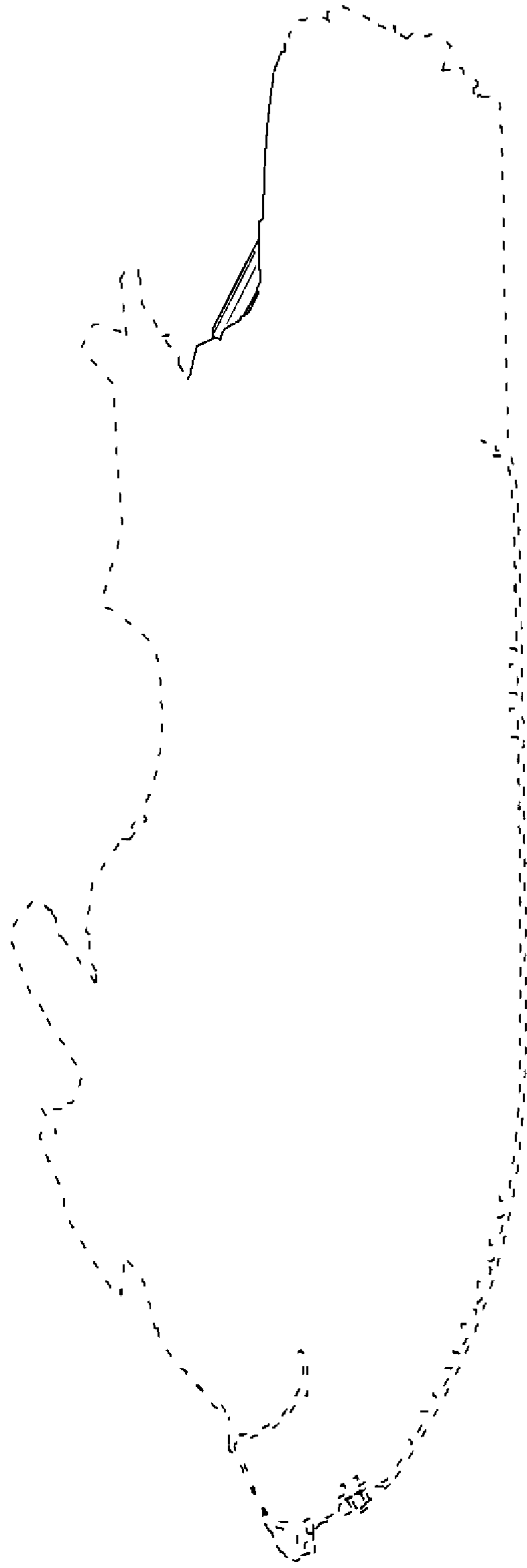

FIG. 8

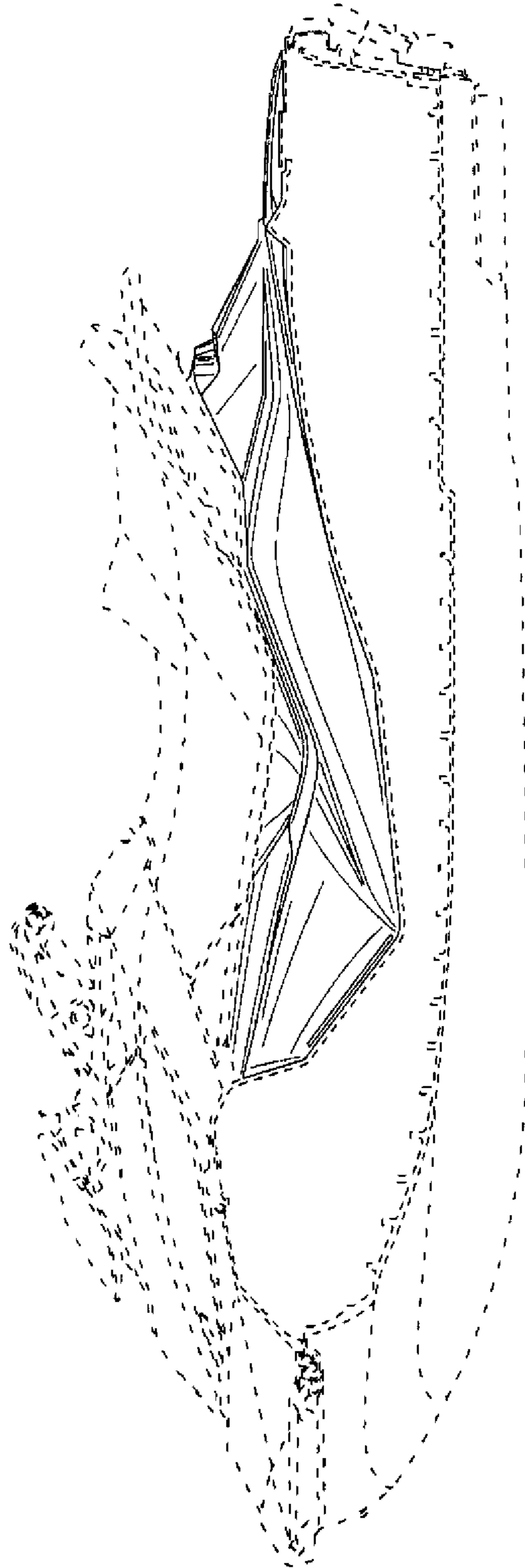

FIG. 9