



US00D636167S

(12) **United States Design Patent**  
**Guers-Neyraud**

(10) **Patent No.:** **US D636,167 S**  
(45) **Date of Patent:** **\*\* Apr. 19, 2011**

(54) **FOOTWEAR**

(75) Inventor: **Elisabeth Guers-Neyraud**, Paris (FR)

(73) Assignee: **J. Choo Limited**, London (GB)

(\*\*) Term: **14 Years**

(21) Appl. No.: **29/348,499**

(22) Filed: **Jan. 12, 2010**

(30) **Foreign Application Priority Data**

Jul. 21, 2009 (EM) ..... 001589086-0002

(51) **LOC (9) Cl.** ..... **02-99**

(52) **U.S. Cl.** ..... **D2/971**

(58) **Field of Classification Search** ..... D2/896,  
D2/916-918, 925-942, 946, 969, 971; 36/1,  
36/83, 8.3, 45-58, 104, 108, 76 R  
See application file for complete search history.

(56) **References Cited**

**U.S. PATENT DOCUMENTS**

D40,391 S *	12/1909	Merz	.....	D2/929
D95,097 S *	4/1935	Weidner	.....	D2/971
D103,584 S *	3/1937	Oswell	.....	D2/930
D103,592 S *	3/1937	Perugia	.....	D2/931
D544,191 S	6/2007	Choi		
D564,203 S	3/2008	Choi		
D591,940 S *	5/2009	Guers-Neyraud et al.	.....	D2/946

D592,842 S	5/2009	Lawler		
D604,936 S *	12/2009	Guers-Neyraud	.....	D2/971
D613,050 S *	4/2010	Lawler	.....	D2/971
D613,052 S *	4/2010	Guers-Neyraud	.....	D2/971
D618,450 S *	6/2010	Guers-Neyraud	.....	D2/971

**OTHER PUBLICATIONS**

U.S. Appl. No. 29/348,488, filed Jan. 12, 2010; first named inventor: Guers-Neyraud.

\* cited by examiner

*Primary Examiner* — Dominic Simone

(74) *Attorney, Agent, or Firm* — Fross Zelnick Lehrman & Zissu, P.C.; Lawrence E. Apolzon, Esq.

(57) **CLAIM**

The ornamental design for footwear, as shown and described.

**DESCRIPTION**

FIG. 1 is a front perspective view of a shoe showing my footwear design;  
FIG. 2 is a left side view of the footwear shown in FIG. 1;  
FIG. 3 is a right side view of the footwear shown in FIG. 1;  
FIG. 4 is a front view of the footwear shown in FIG. 1;  
FIG. 5 is a rear view of the footwear shown in FIG. 1; and,  
FIG. 6 is a top view of the footwear shown in FIG. 1.  
The broken line showing of the sole, heel, heel cap, heel cup, buckle, buckle holes, toe strap, portions of the rear straps, and footbed is for illustrative purposes only and forms no part of the claimed design.

**1 Claim, 6 Drawing Sheets**

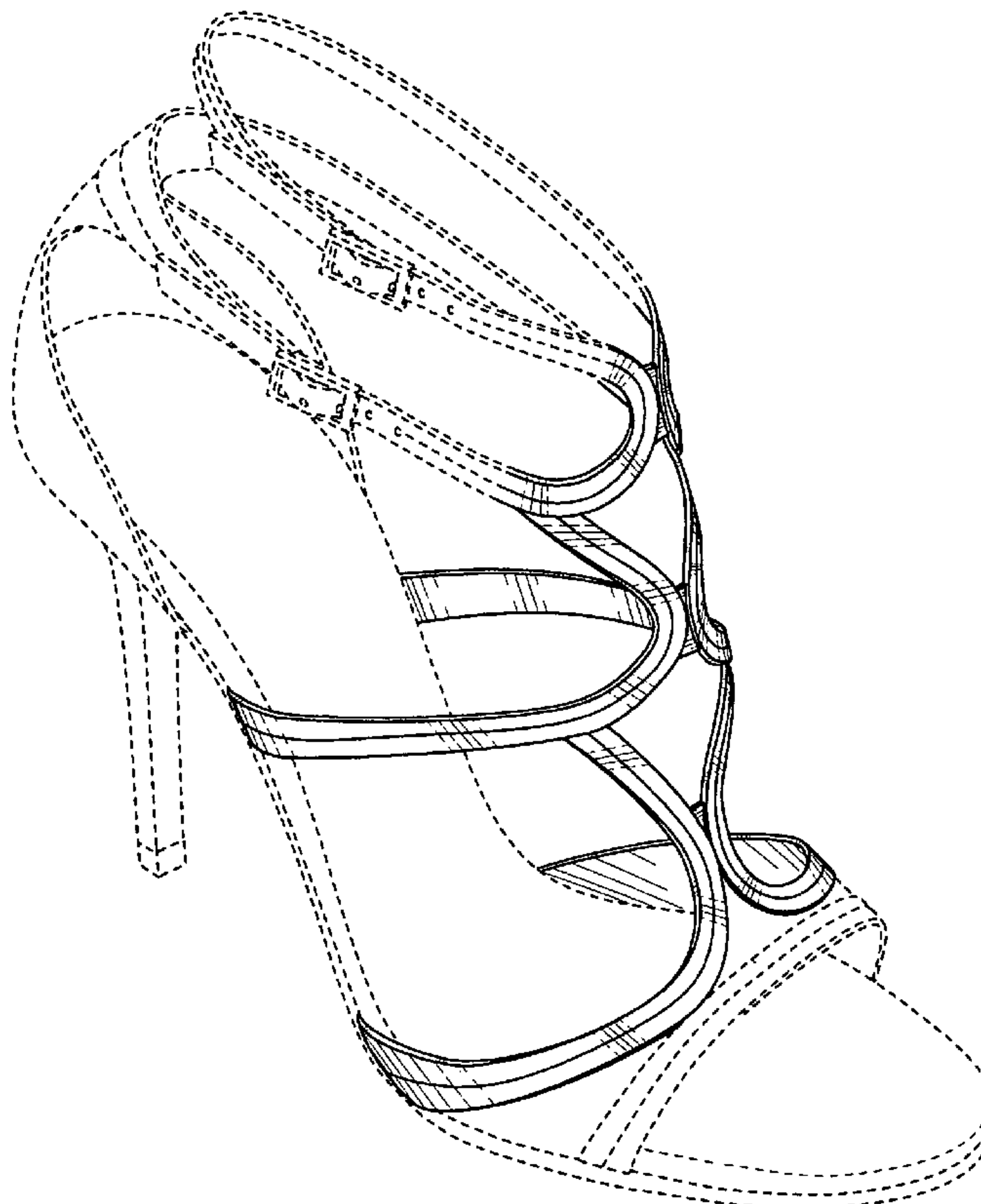

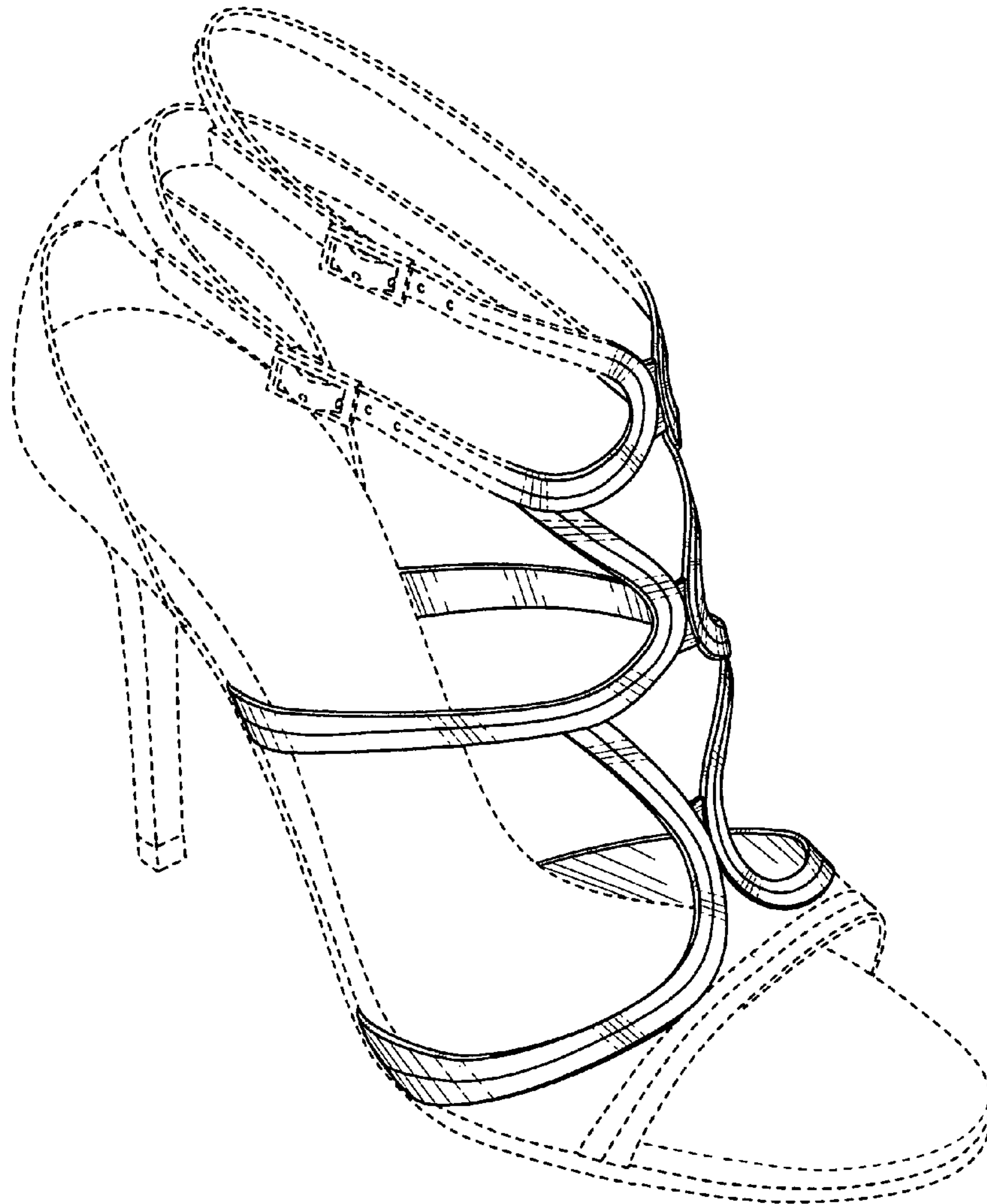

FIG. 1

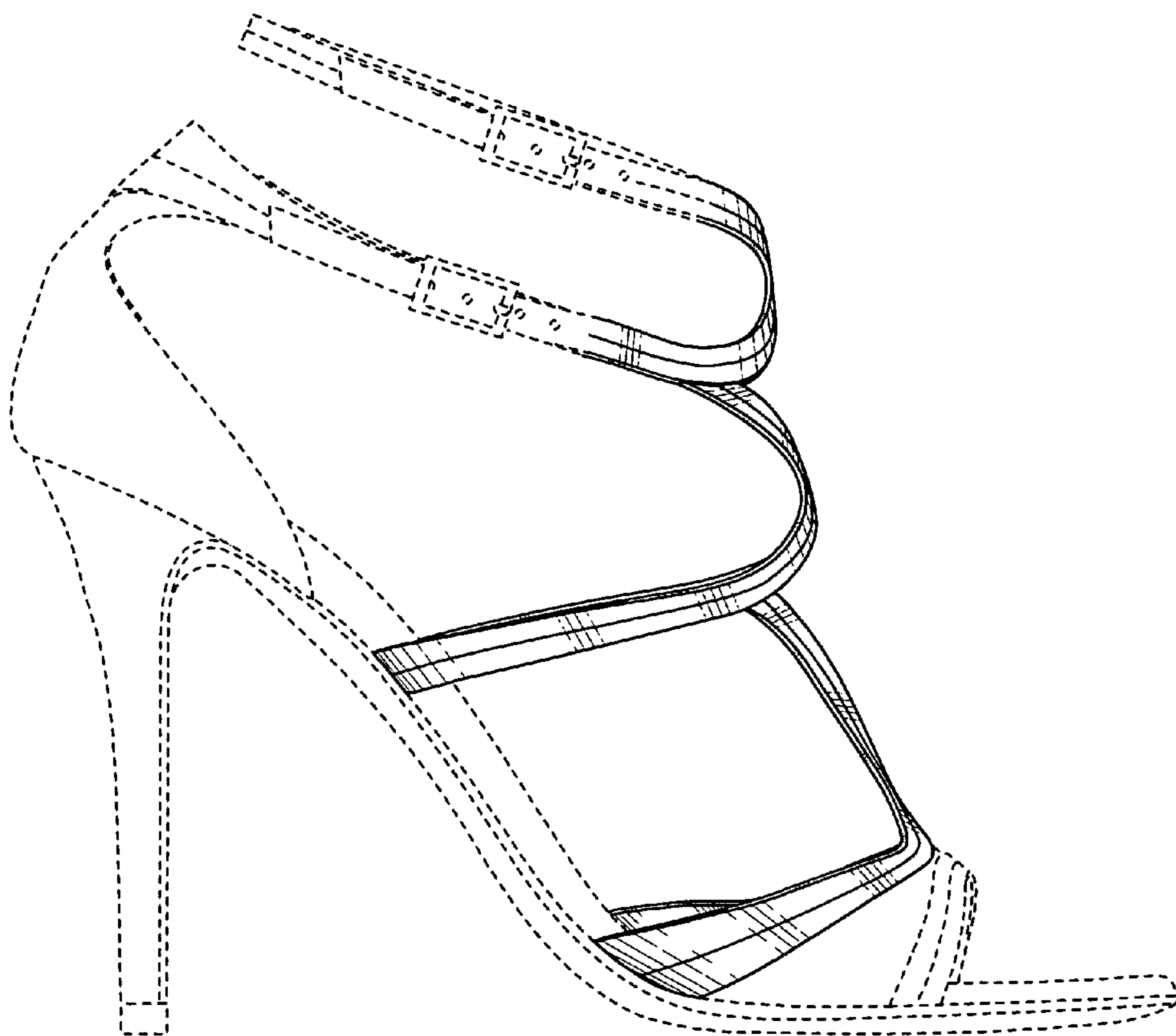

FIG. 2

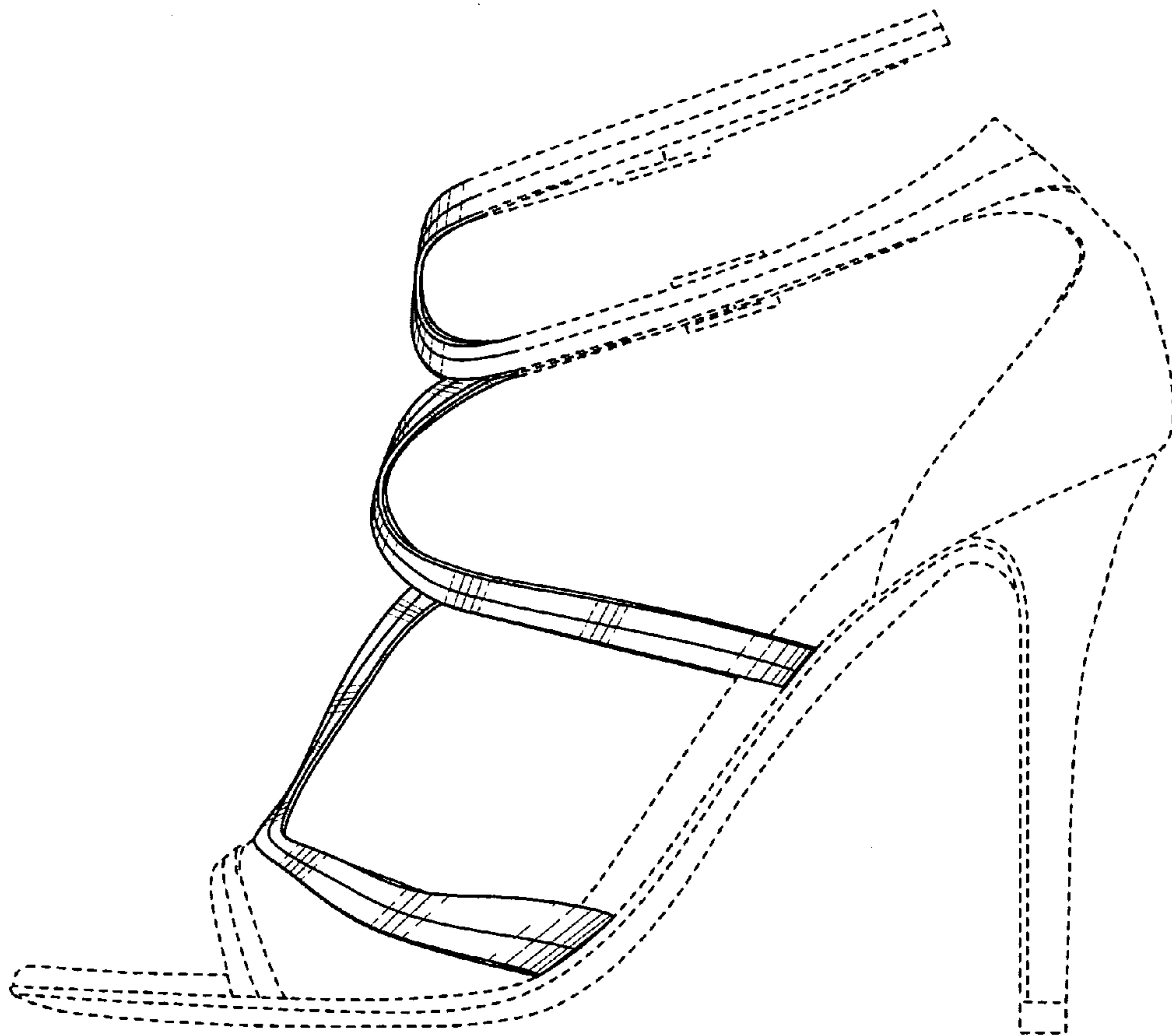

FIG. 3

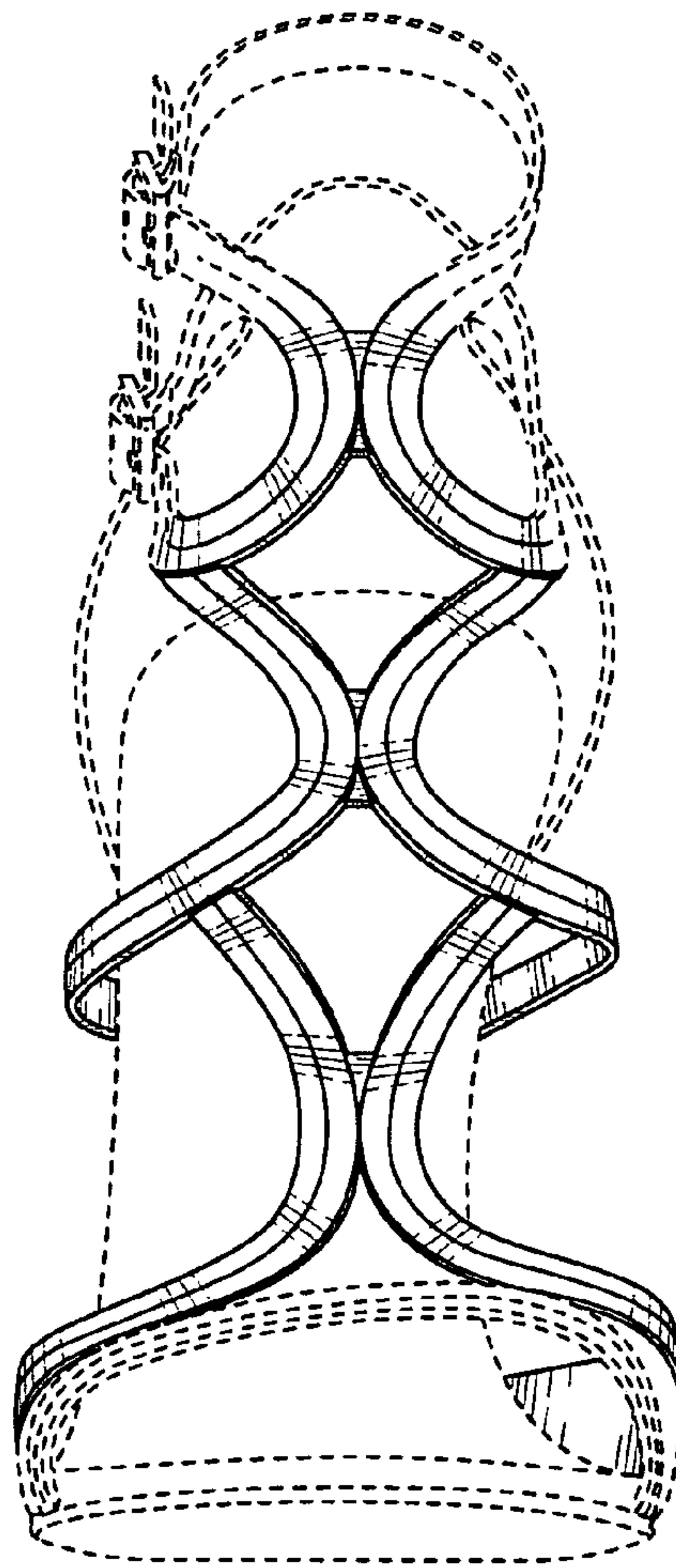

FIG. 4



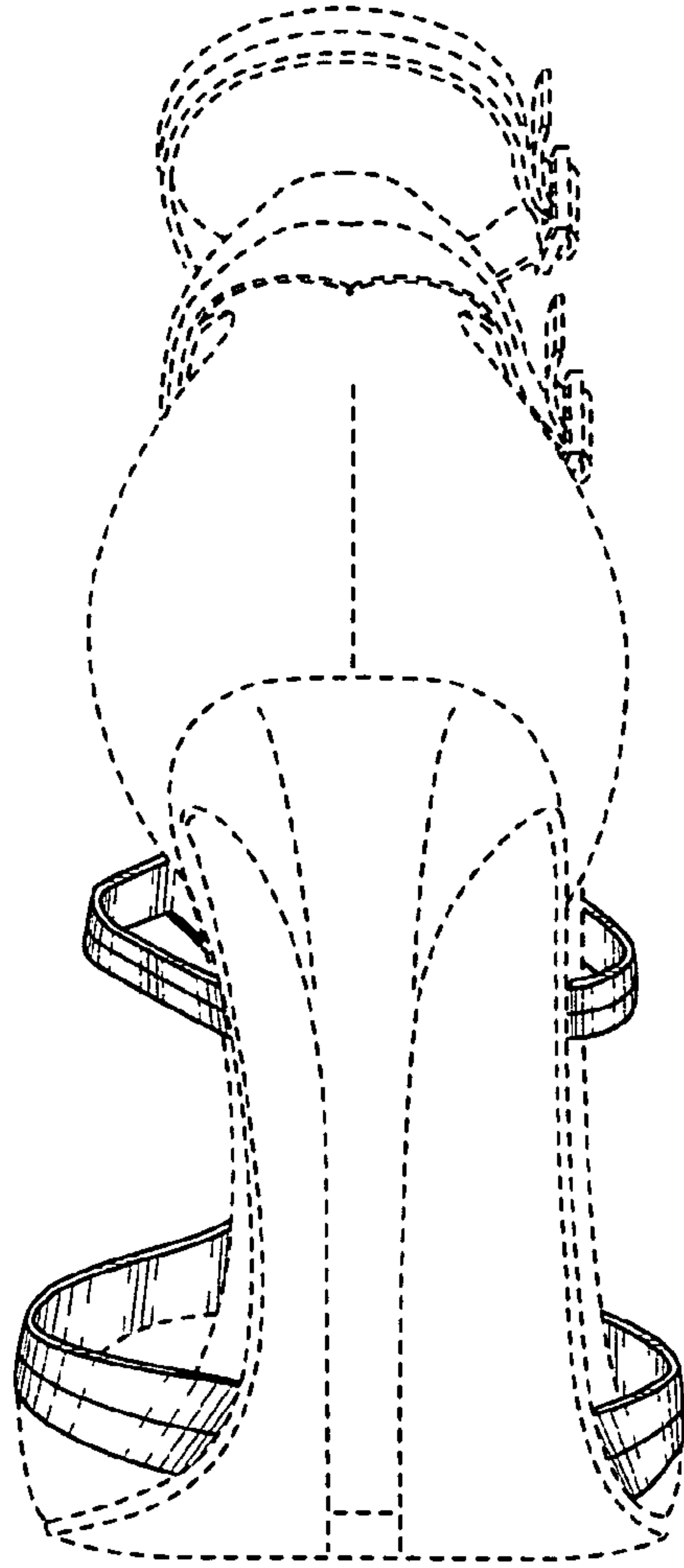

FIG. 5

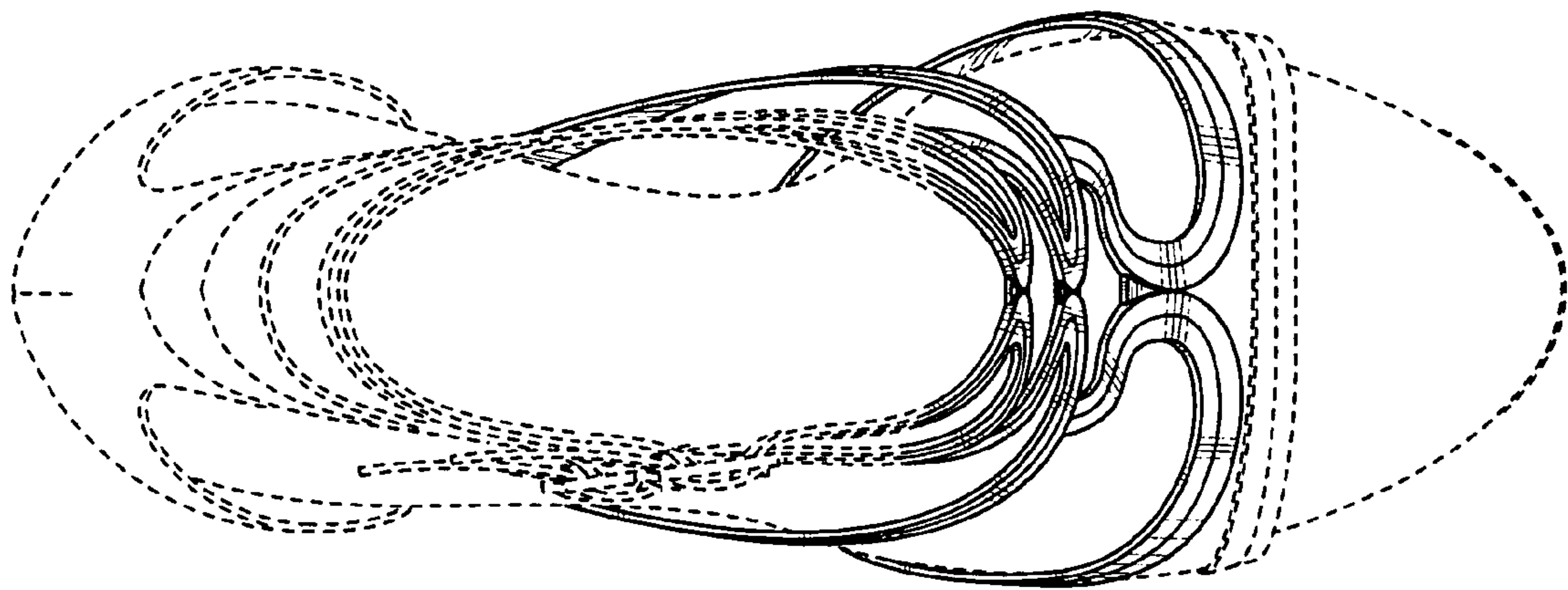

FIG. 6