



US00D636137S

(12) **United States Design Patent**
Chesser

(10) **Patent No.:** **US D636,137 S**

(45) **Date of Patent:** **** *Apr. 12, 2011**

(54) **BUCKET**

(76) Inventor: **Derek S. Chesser**, Tampa, FL (US)

(*) Notice: This patent is subject to a terminal disclaimer.

(**) Term: **14 Years**

(21) Appl. No.: **29/348,357**

(22) Filed: **Dec. 22, 2009**

Related U.S. Application Data

(63) Continuation of application No. 29/314,008, filed on Feb. 26, 2009, now abandoned.

(51) **LOC (9) Cl.** **07-07**

(52) **U.S. Cl.** **D32/53**

(58) **Field of Classification Search** D32/53,
D32/53.1, 54; 220/570, 495.01, 495.02,
220/904, 908; 15/260, 264, 257.06
See application file for complete search history.

(56) **References Cited**

U.S. PATENT DOCUMENTS

2,519,666 A * 8/1950 Knox 220/736
D295,093 S * 4/1988 Tapdrup D32/53

D295,094 S * 4/1988 Tapdrup D32/53
D495,448 S * 8/2004 Moforis D28/61
D593,269 S * 5/2009 Weiler D32/53

* cited by examiner

Primary Examiner — Robin V Webster

(74) *Attorney, Agent, or Firm* — Frijouf, Rust & Pyle, P.A.

(57) **CLAIM**

The ornamental design for a bucket, as shown and described.

DESCRIPTION

FIG. 1 is a top isometric view of a first embodiment of my new design for a container;

FIG. 2 is a bottom isometric view thereof;

FIG. 3 is a front view and a rear view thereof;

FIG. 4 is a left side and a right side view thereof;

FIG. 5 is a top view thereof;

FIG. 6 is a bottom view thereof;

FIG. 7 is a top isometric view of a second embodiment of my new design for a container;

FIG. 8 is a bottom isometric view thereof;

FIG. 9 is a front view and a rear view thereof;

FIG. 10 is a left side and a right side view thereof;

FIG. 11 is a top view thereof; and,

FIG. 12 is a bottom view thereof.

1 Claim, 6 Drawing Sheets

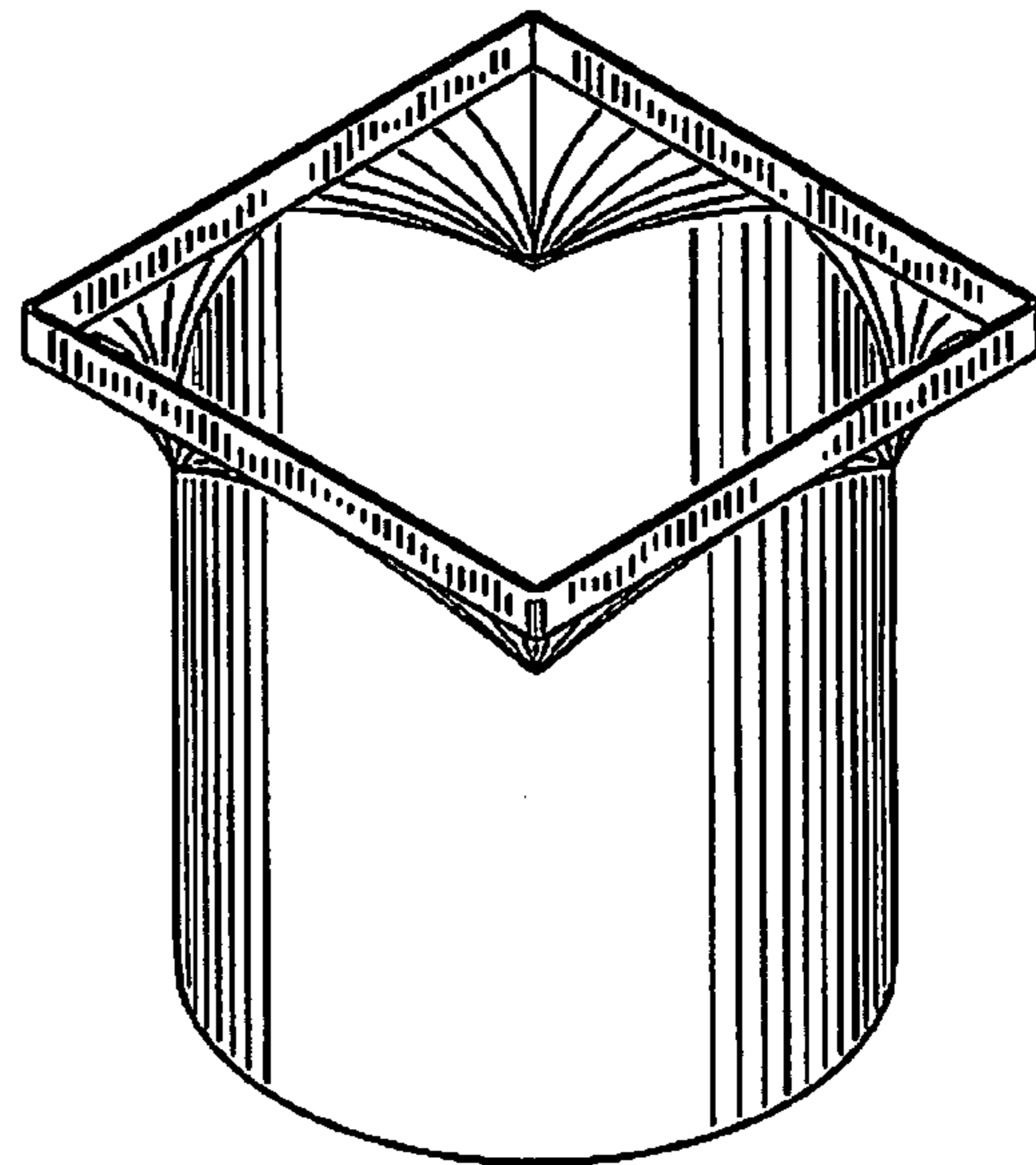
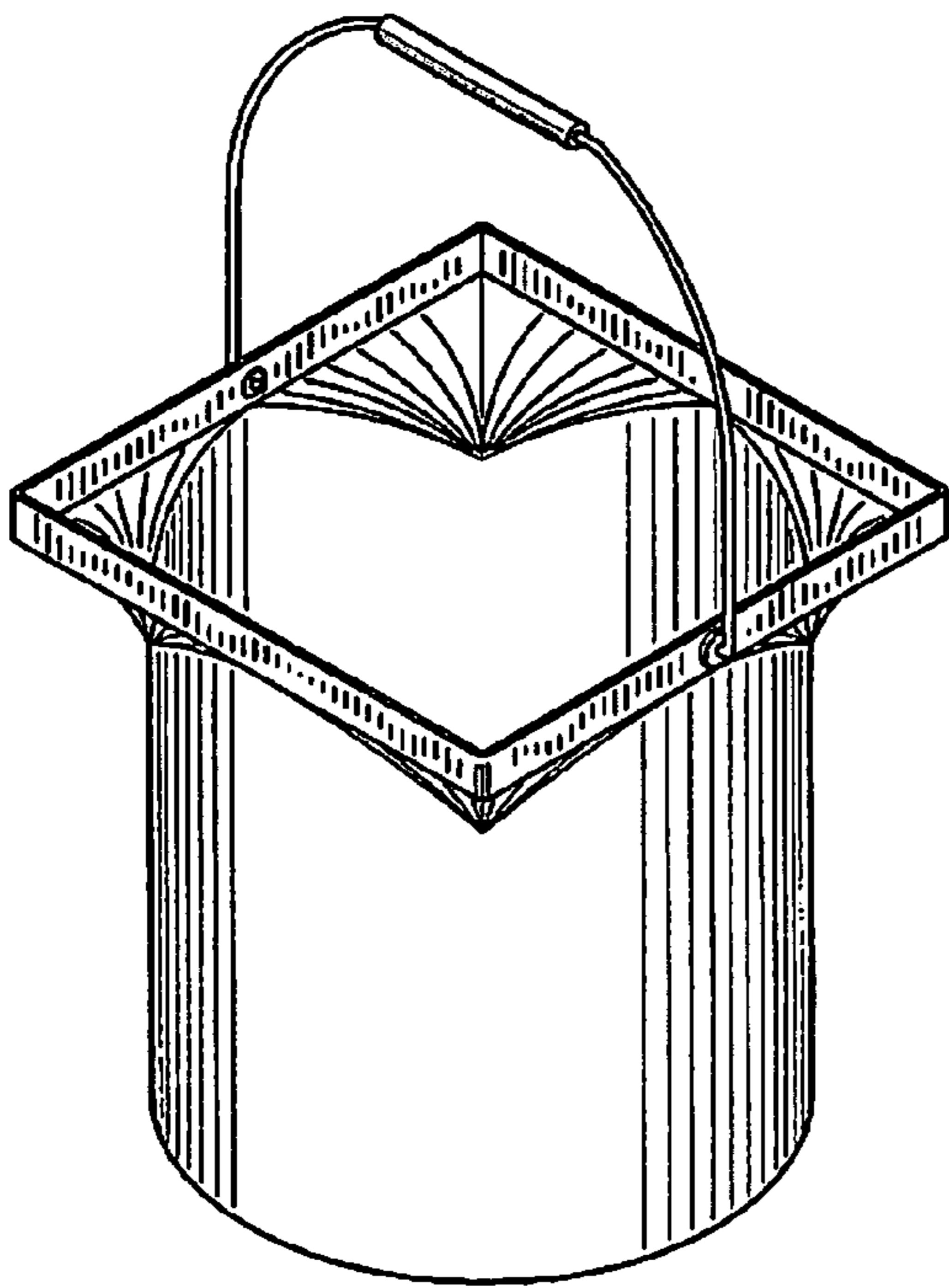

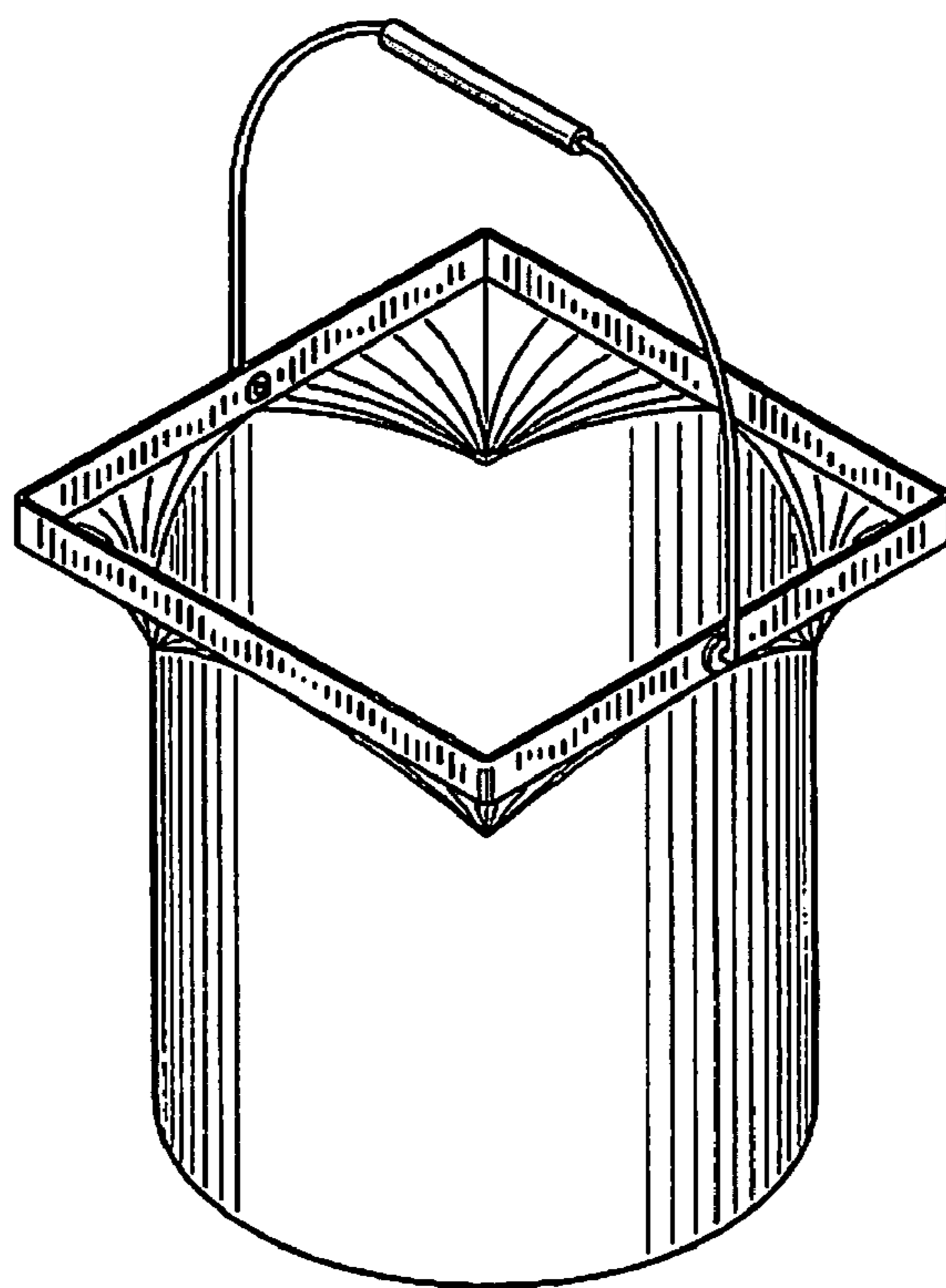

FIG. 1

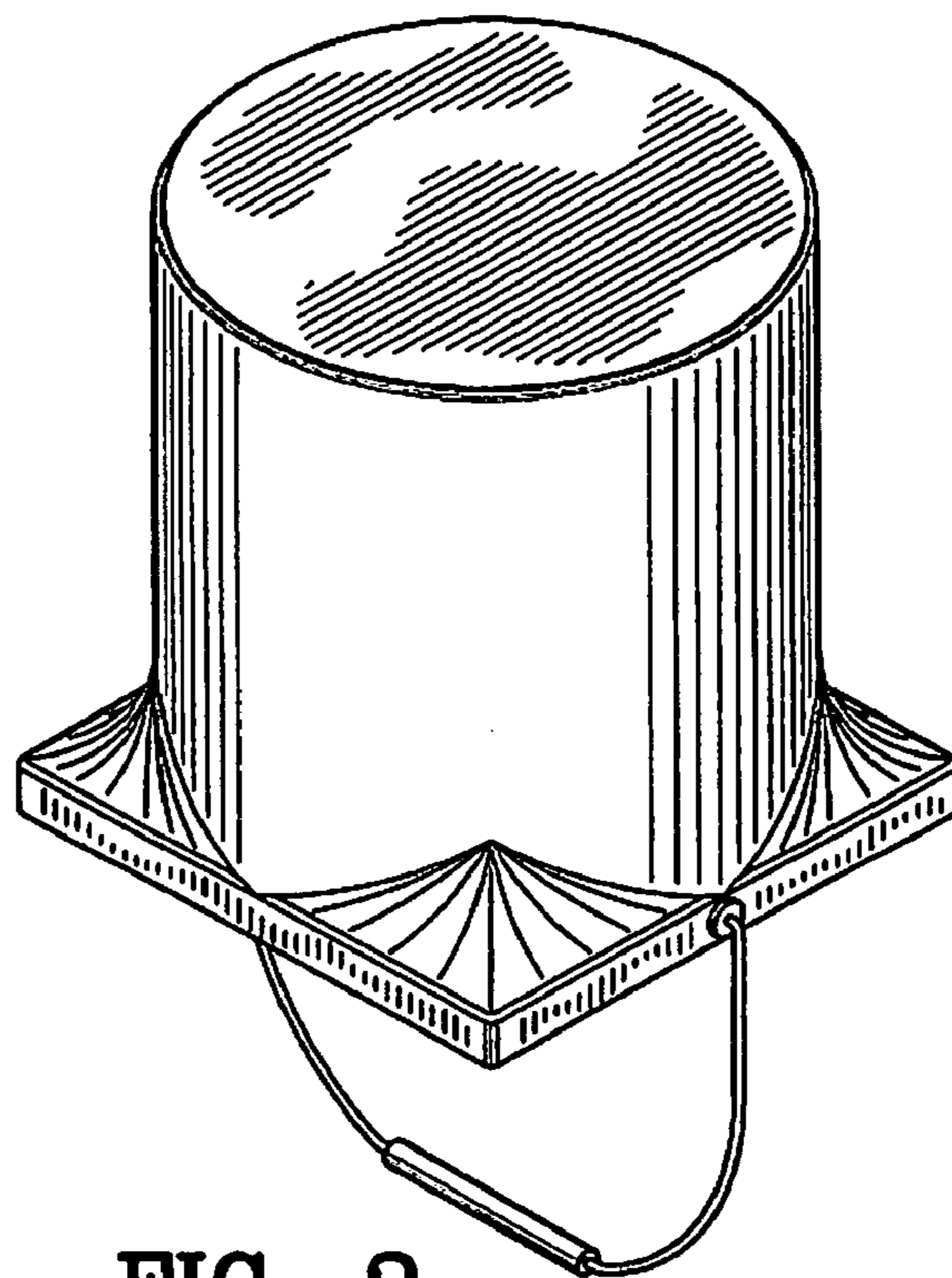

FIG. 2

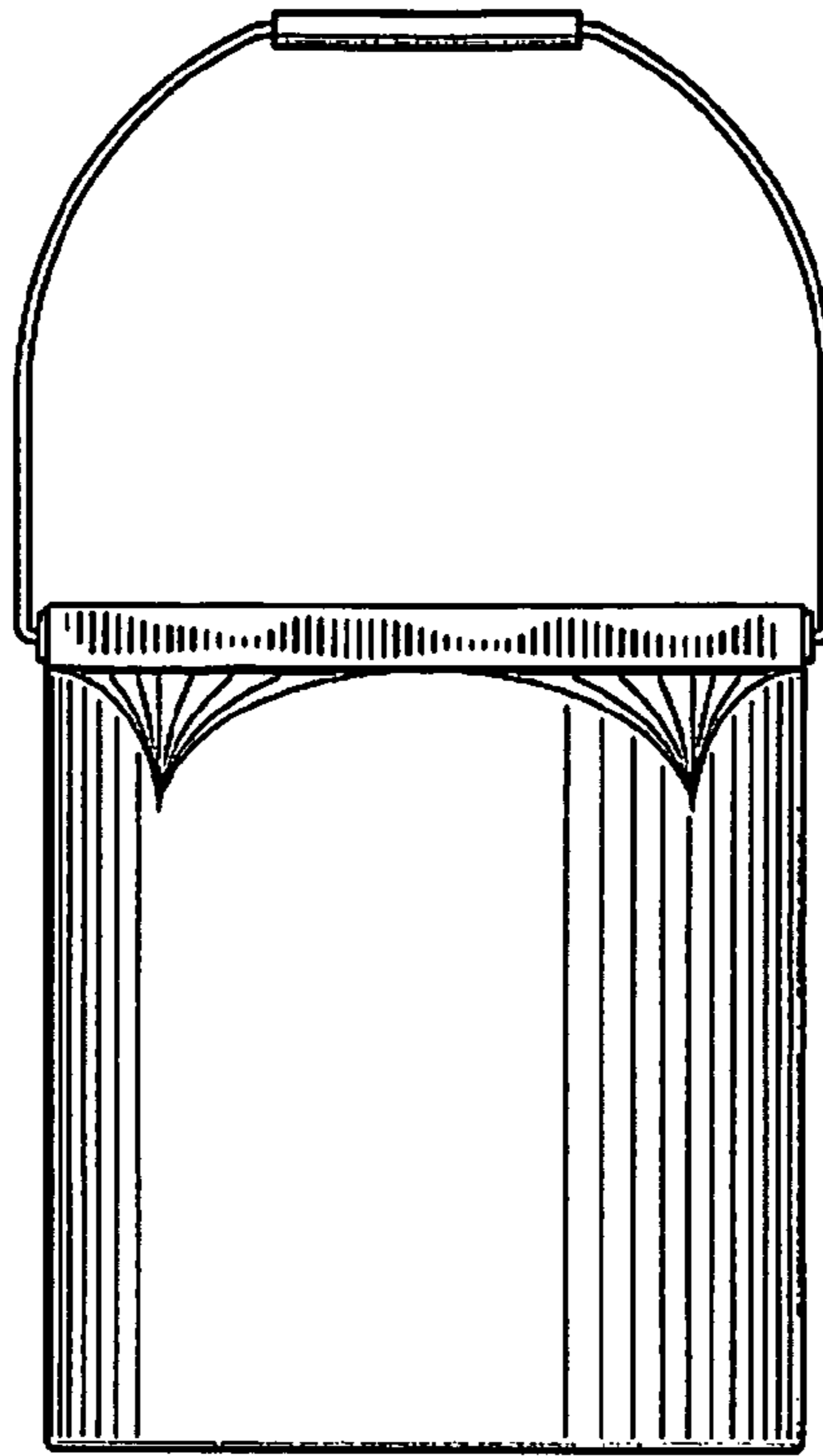

FIG. 3

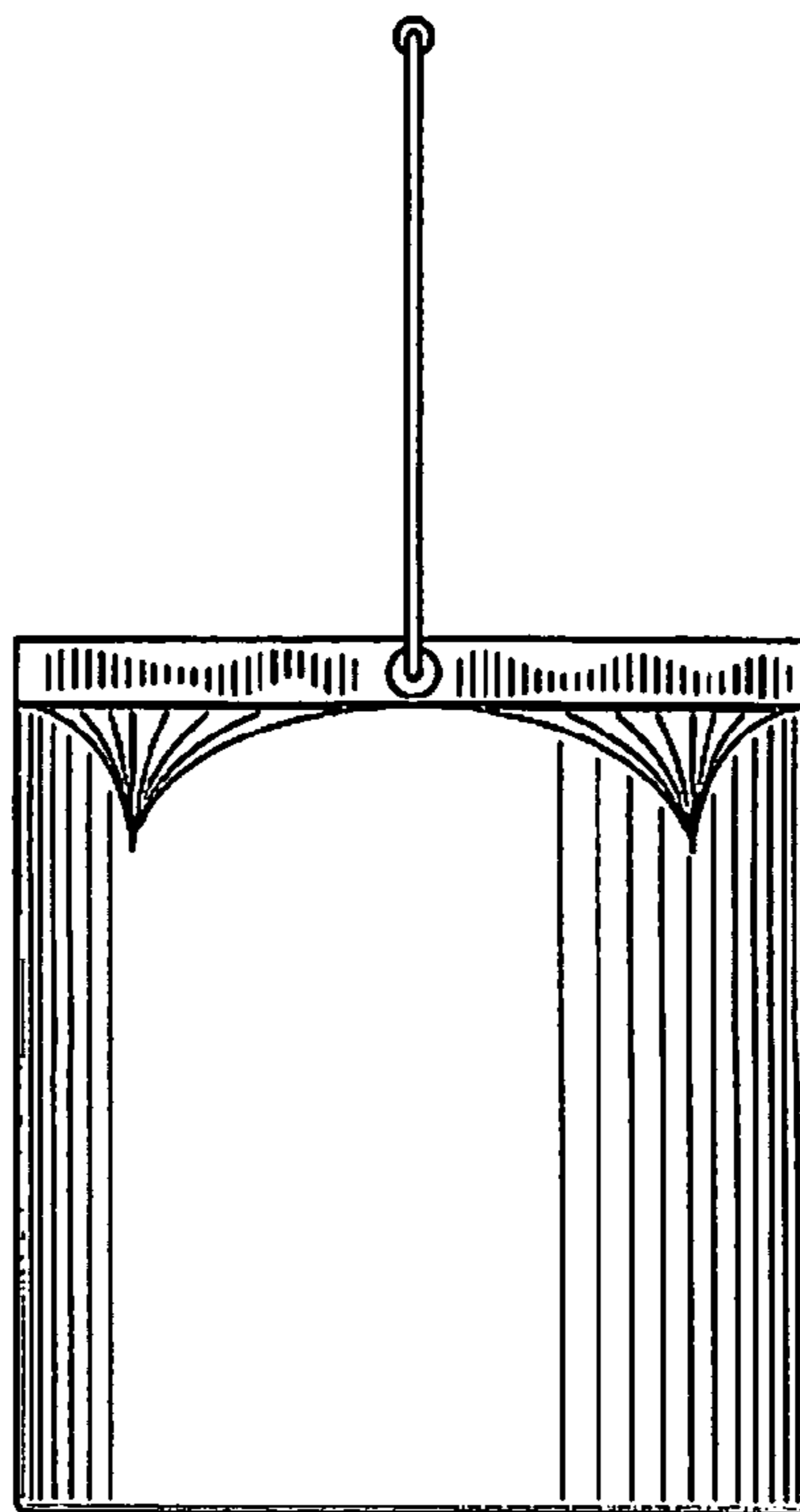

FIG. 4

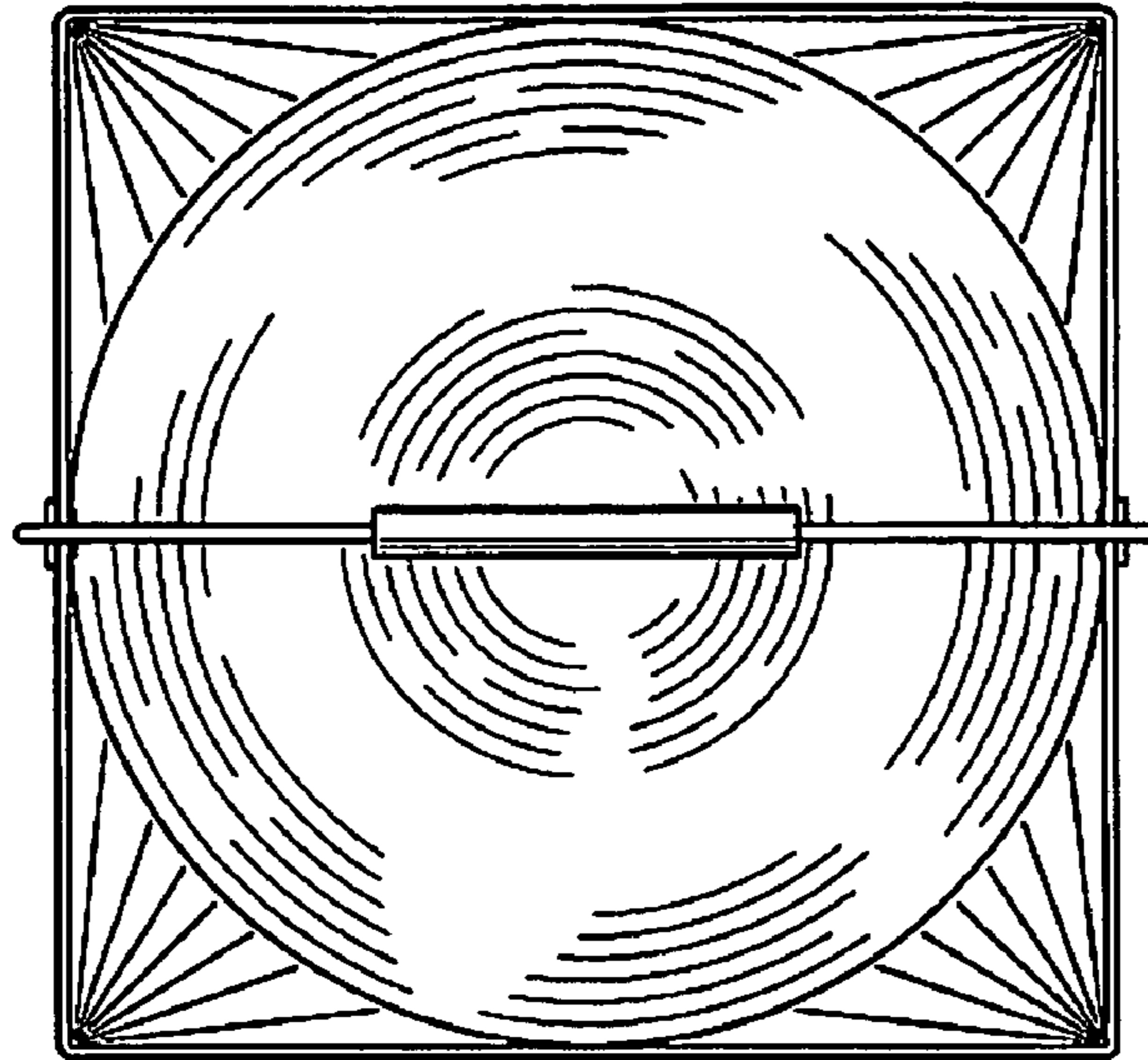

FIG. 5

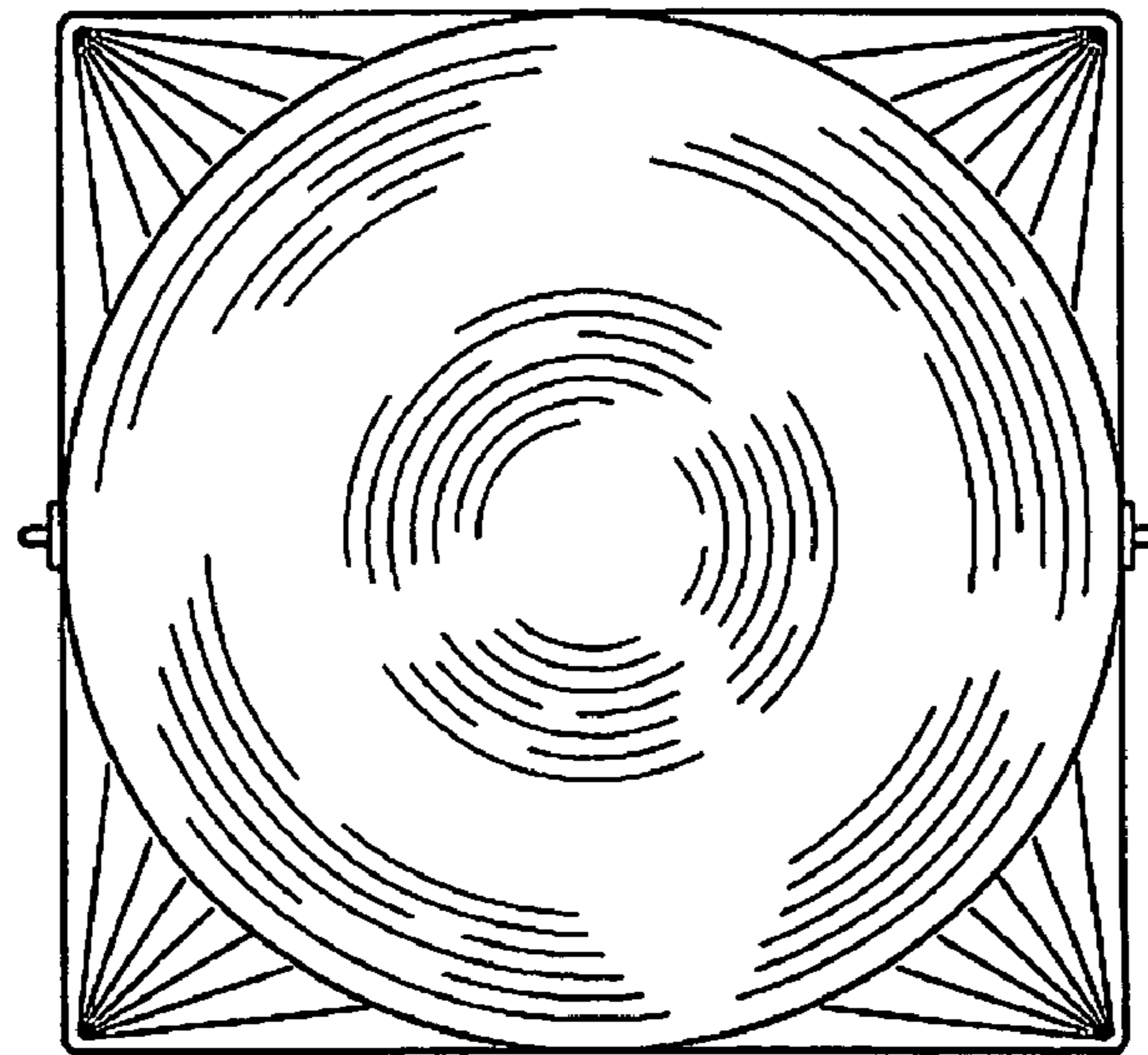

FIG. 6

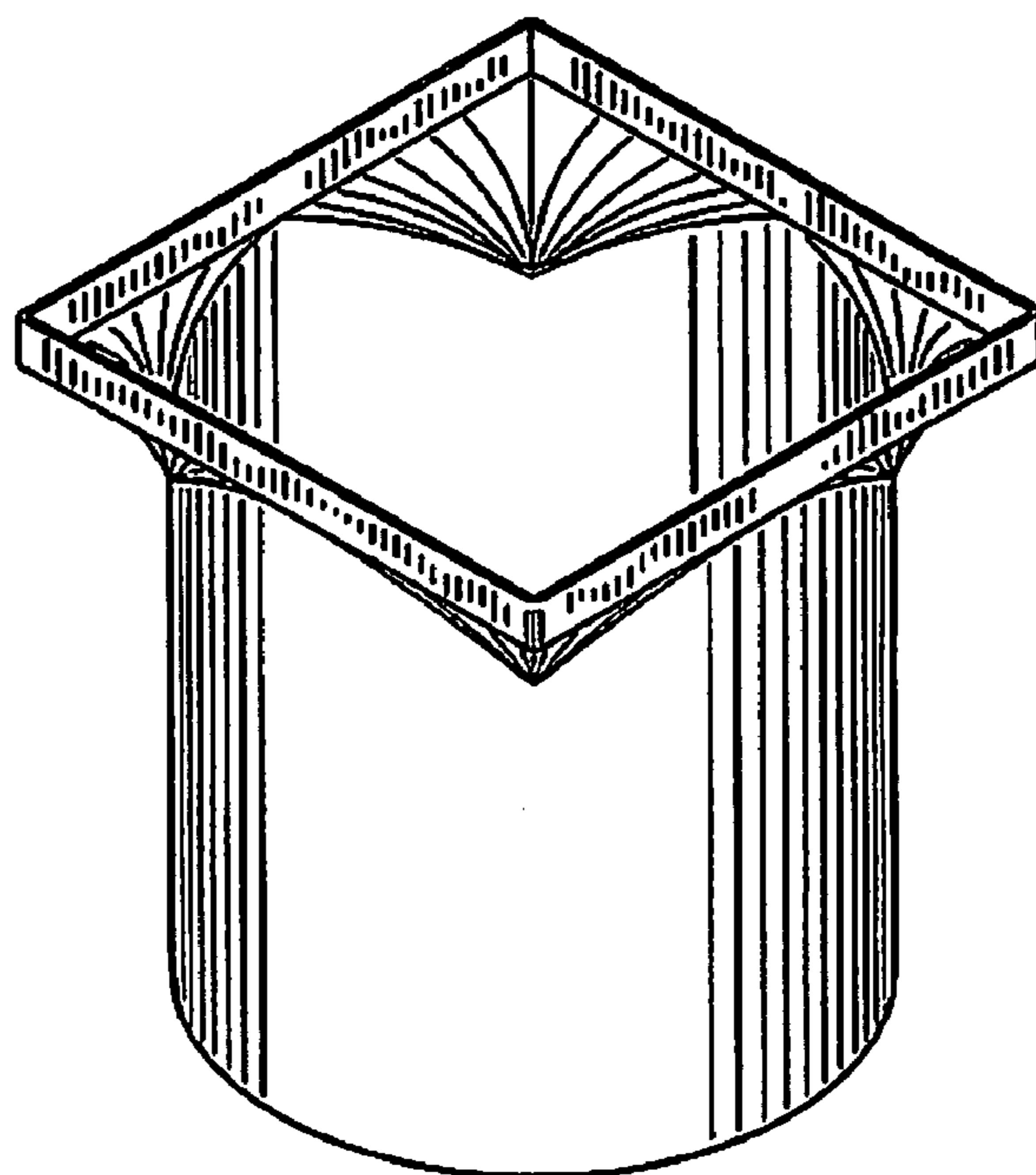

FIG. 7

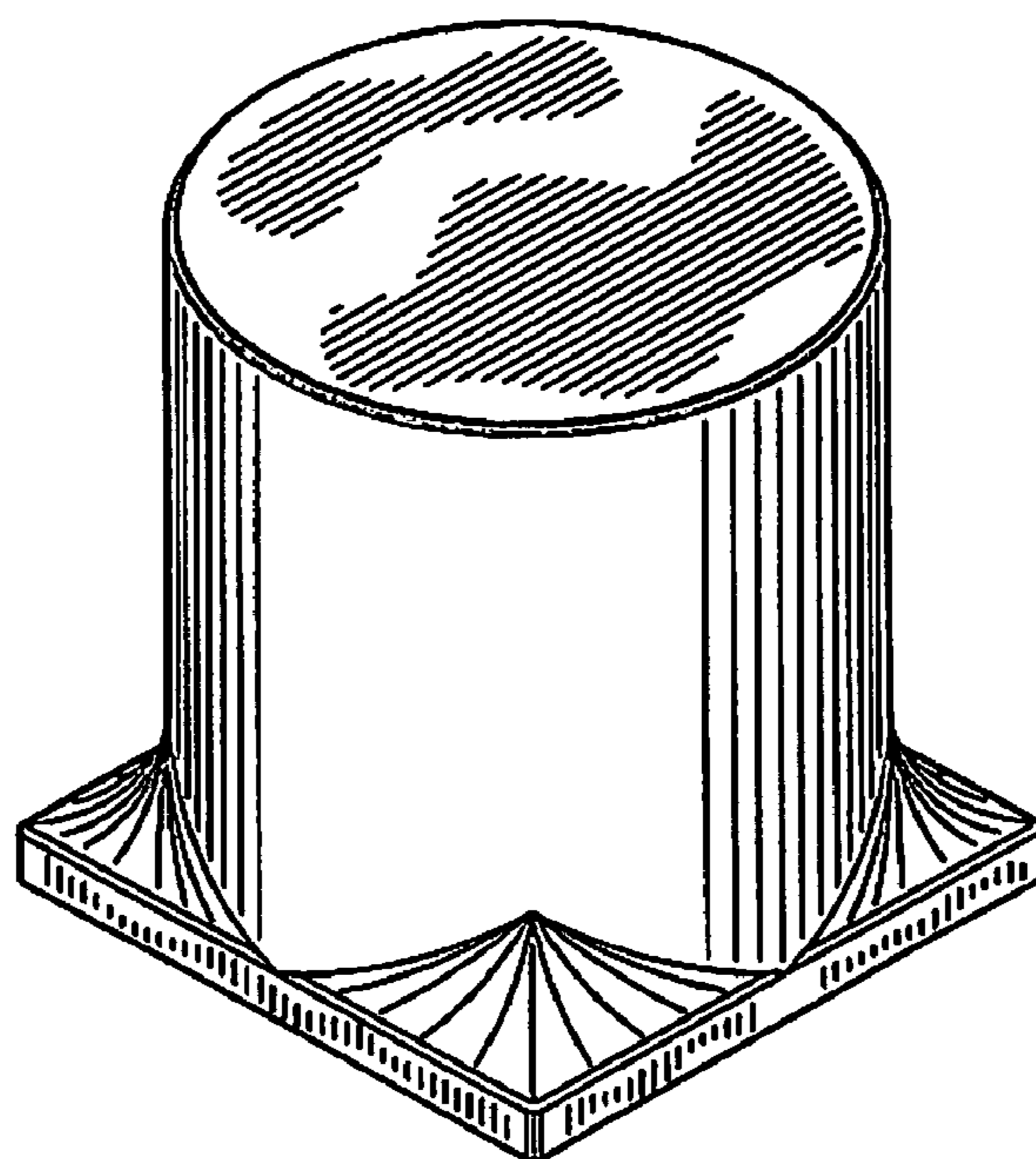

FIG. 8

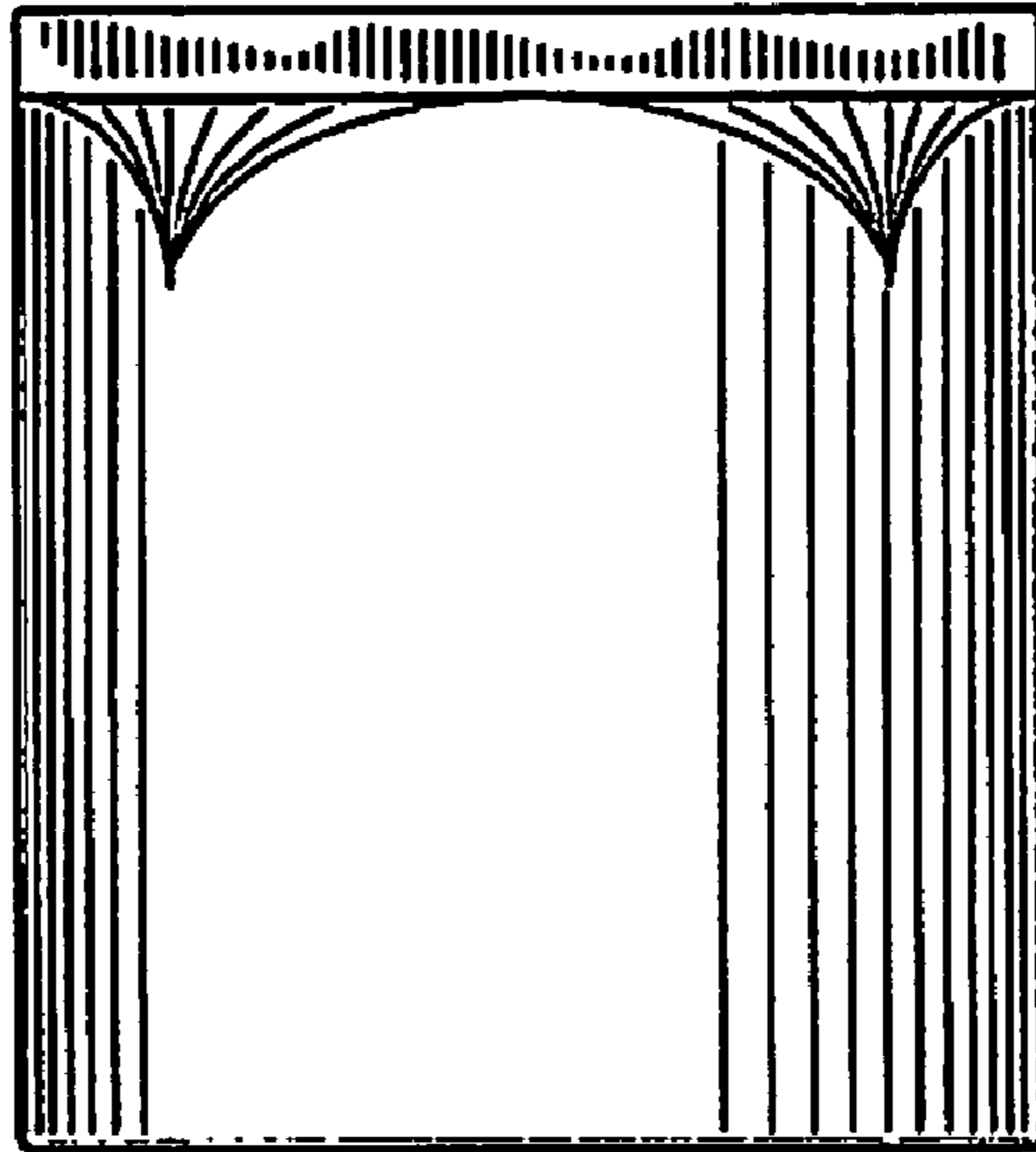

FIG. 9

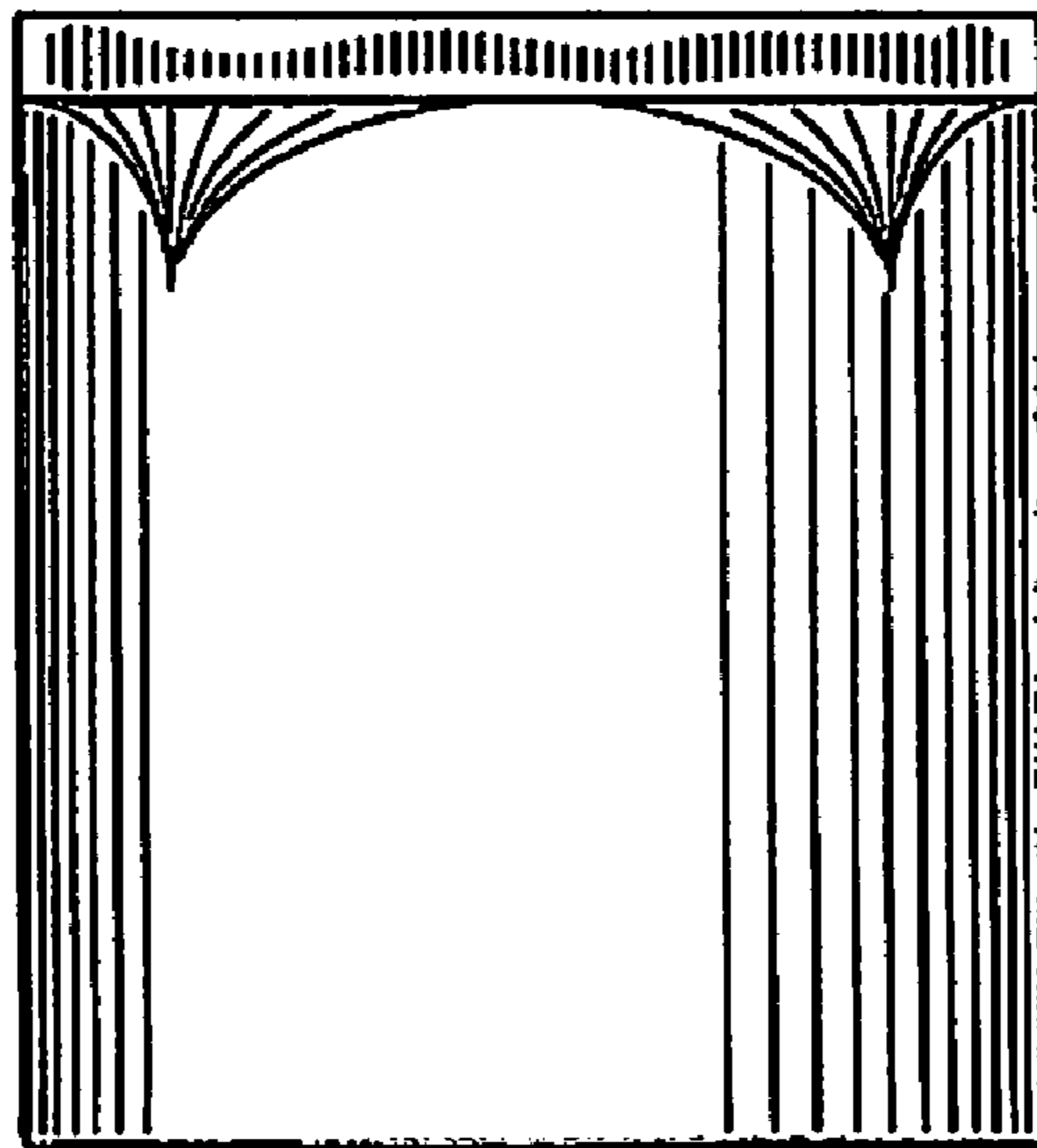

FIG. 10

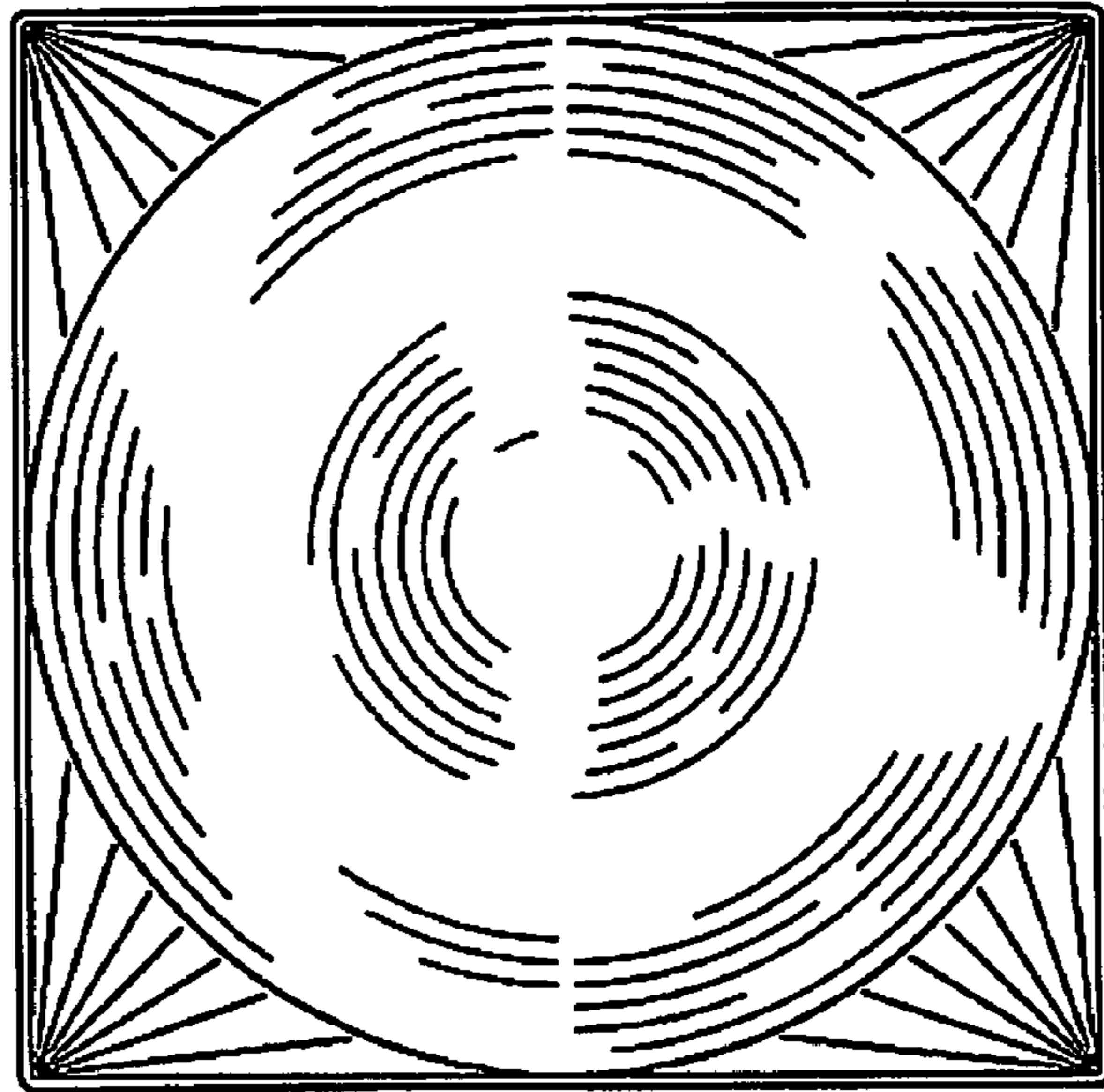

FIG. 11

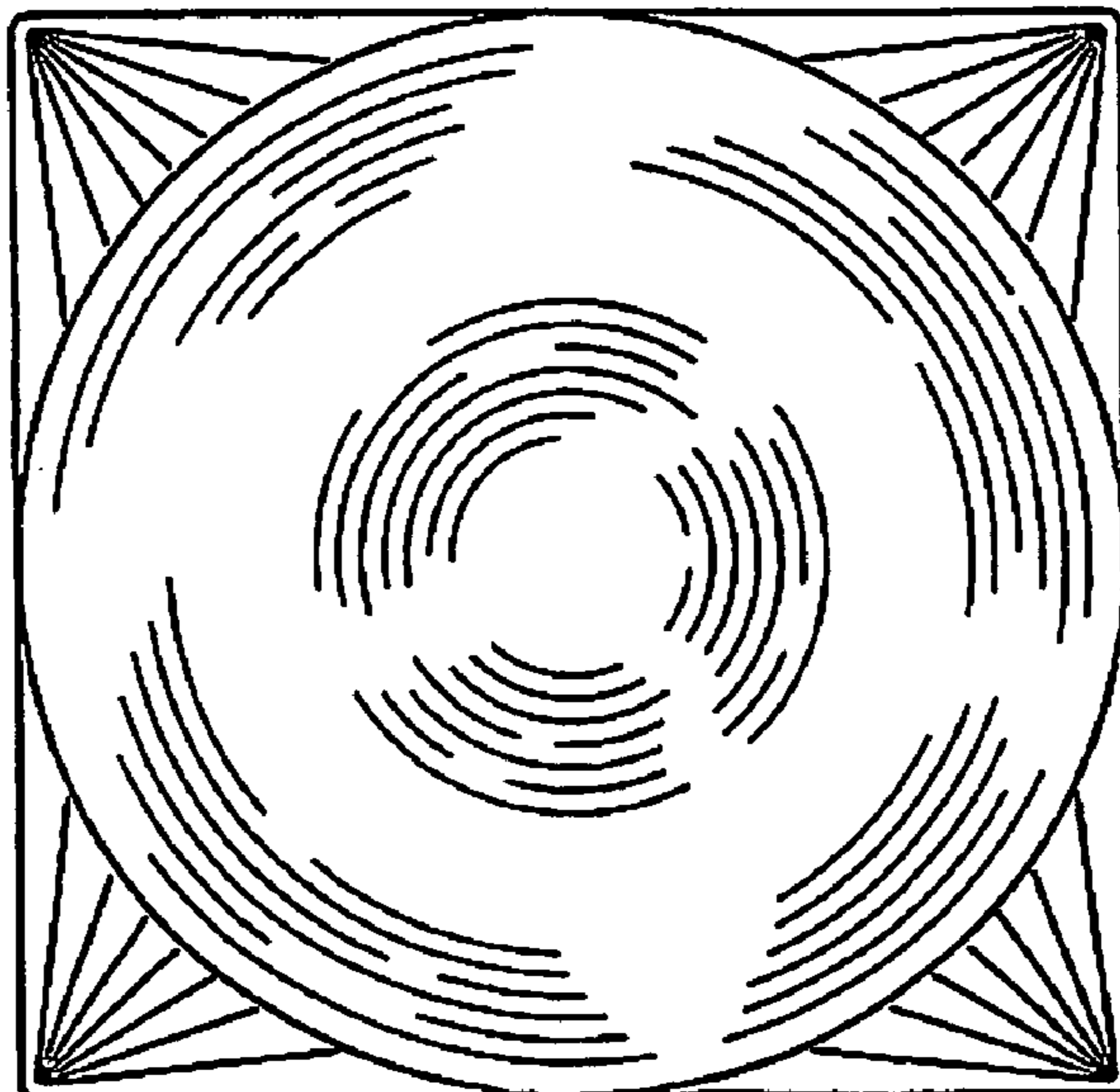

FIG. 12