



US00D636128S

(12) **United States Design Patent**
Hancock et al.

(10) **Patent No.:** **US D636,128 S**

(45) **Date of Patent:** **** Apr. 12, 2011**

(54) **DUST MASK**

(76) Inventors: **Jeffrey D. Hancock**, Uintah, UT (US);
Dennis H. Hancock, Morgan, UT (US)

(**) Term: **14 Years**

(21) Appl. No.: **29/348,352**

(22) Filed: **Dec. 24, 2009**

(51) **LOC (9) Cl.** **29-02**

(52) **U.S. Cl.** **D29/108**

(58) **Field of Classification Search** D29/108-110,
D29/122; D24/110.1; 128/858, 863, 201.23,
128/206.12, 206.13, 206.16, 206.19, 206.28,
128/206.11; 2/9, 206, 5, 6.6, 411-414, 424,
2/425

See application file for complete search history.

(56) **References Cited**

U.S. PATENT DOCUMENTS

D248,497 S *	7/1978	Slosek	D24/110.1
D250,131 S *	10/1978	Lewis et al.	D24/110.1
D267,985 S *	2/1983	Huber	D24/110.1
D273,145 S *	3/1984	Ponsi	D24/110.1
D277,520 S *	2/1985	Gregory	D24/110.1
D285,374 S *	8/1986	Huber et al.	D24/110.1
D285,733 S *	9/1986	Cooper	D24/110.1
D326,541 S *	5/1992	McBrearty, Jr.	D24/110.1
D340,317 S *	10/1993	Cole	D24/110.1
5,628,308 A *	5/1997	Harges et al.	128/206.21
D380,545 S *	7/1997	Nozaki et al.	D24/110.1
5,842,470 A *	12/1998	Ruben	128/206.19
D420,769 S *	2/2000	White	D29/108
6,041,782 A *	3/2000	Angadjivand et al.	...	128/206.19
D430,361 S *	8/2000	Smith	D29/108

6,116,236 A *	9/2000	Wyss	128/200.24
D434,879 S *	12/2000	Cole	D29/122
D440,302 S *	4/2001	Wolfe	D24/110.1
D443,927 S *	6/2001	Chen	D24/110.1
D464,726 S *	10/2002	Wolfe	D24/110.1
D511,209 S *	11/2005	Callan	D24/110.1
7,131,442 B1 *	11/2006	Kronzer et al.	128/205.27
2003/0154984 A1 *	8/2003	Fernandes	128/205.27
2008/0230066 A1 *	9/2008	Chandaria	128/206.13

* cited by examiner

Primary Examiner — Ruth McInroy

(57) **CLAIM**

An ornamental design for a dust mask, as shown and described.

DESCRIPTION

FIG. 1 is a front perspective view of a dust mask showing our new design, the person shown in broken lines forms no part of the claimed design;

FIG. 2 is a front perspective view thereof;

FIG. 3 is a front elevation view thereof;

FIG. 4 is a right side elevation view thereof;

FIG. 5 is a left side elevation view thereof;

FIG. 6 is a rear elevation view thereof;

FIG. 7 is a top plan view thereof; and,

FIG. 8 is a bottom plan view thereof.

The broken lines on the mask represent conventional stitching. The crosshatch shading is understood to repeat throughout the indicated area.

1 Claim, 5 Drawing Sheets

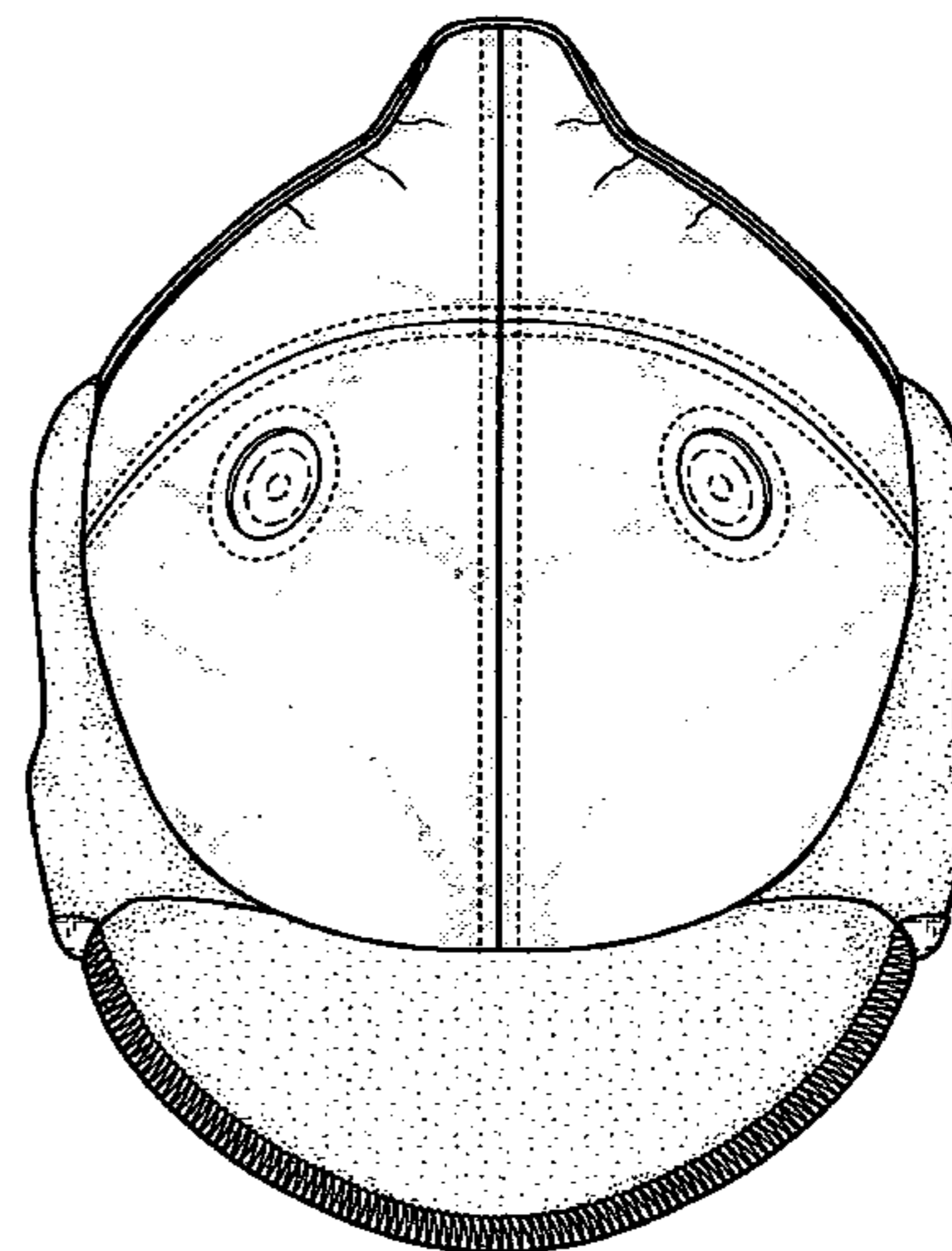
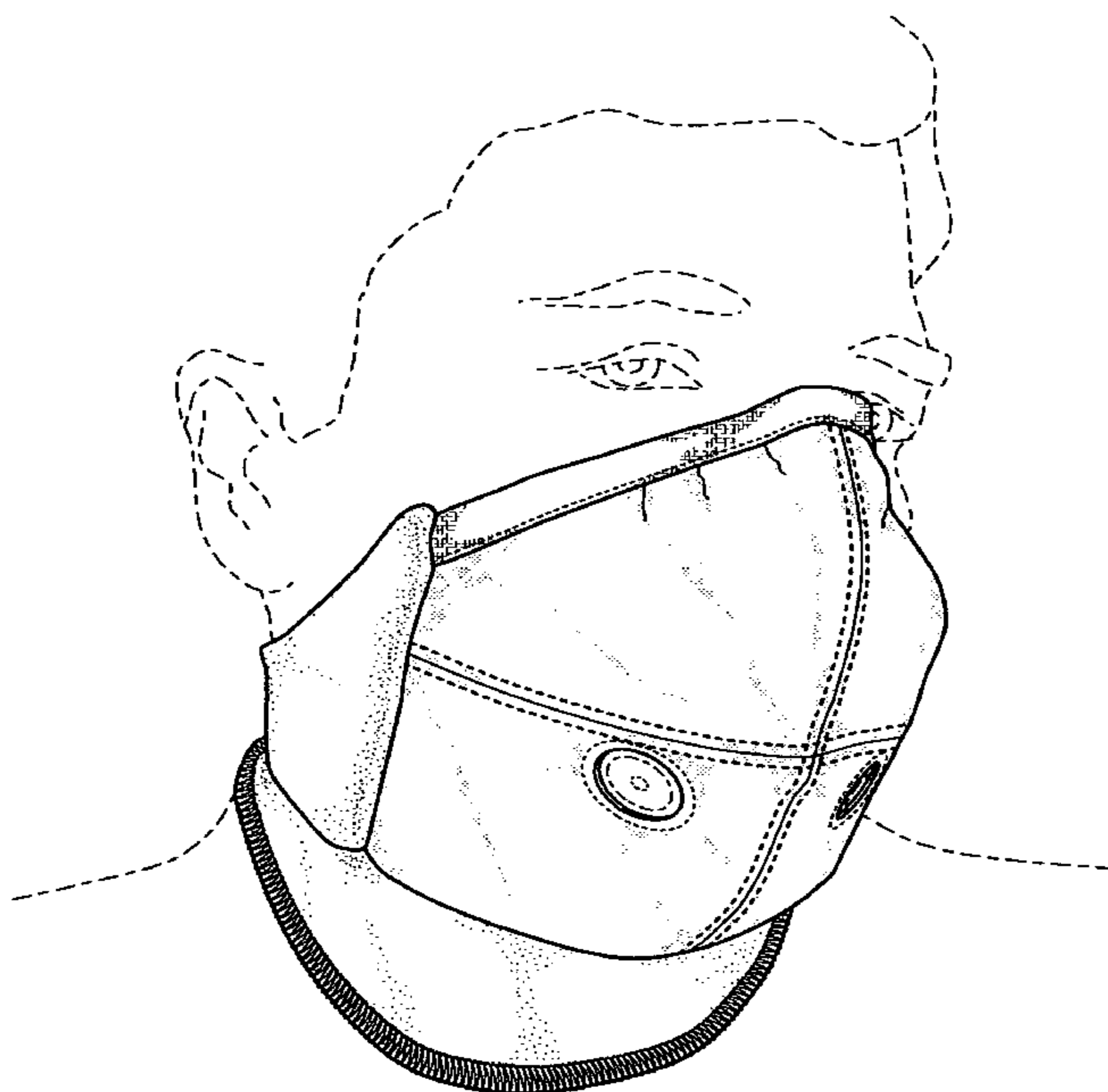

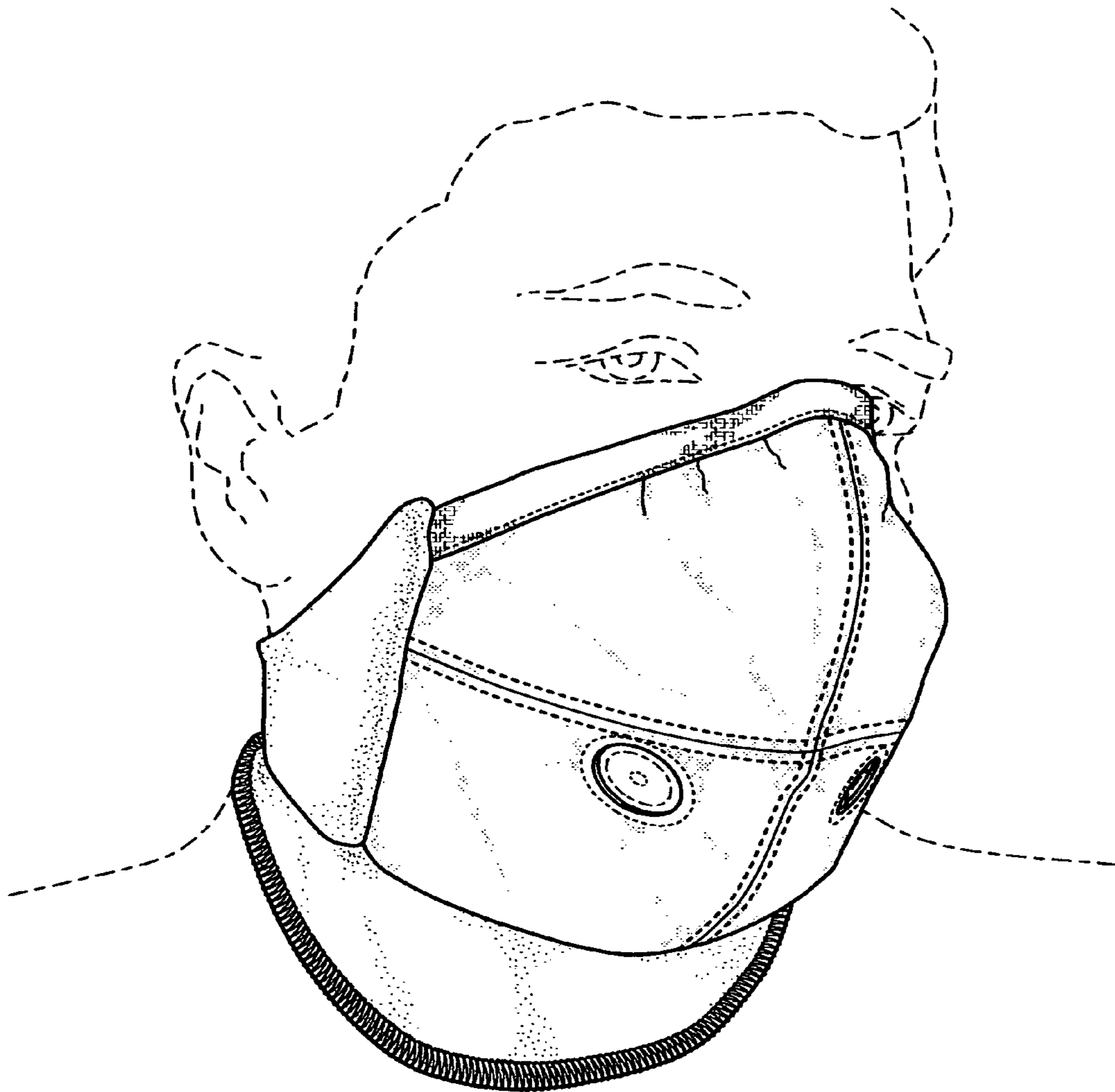

FIG. 1

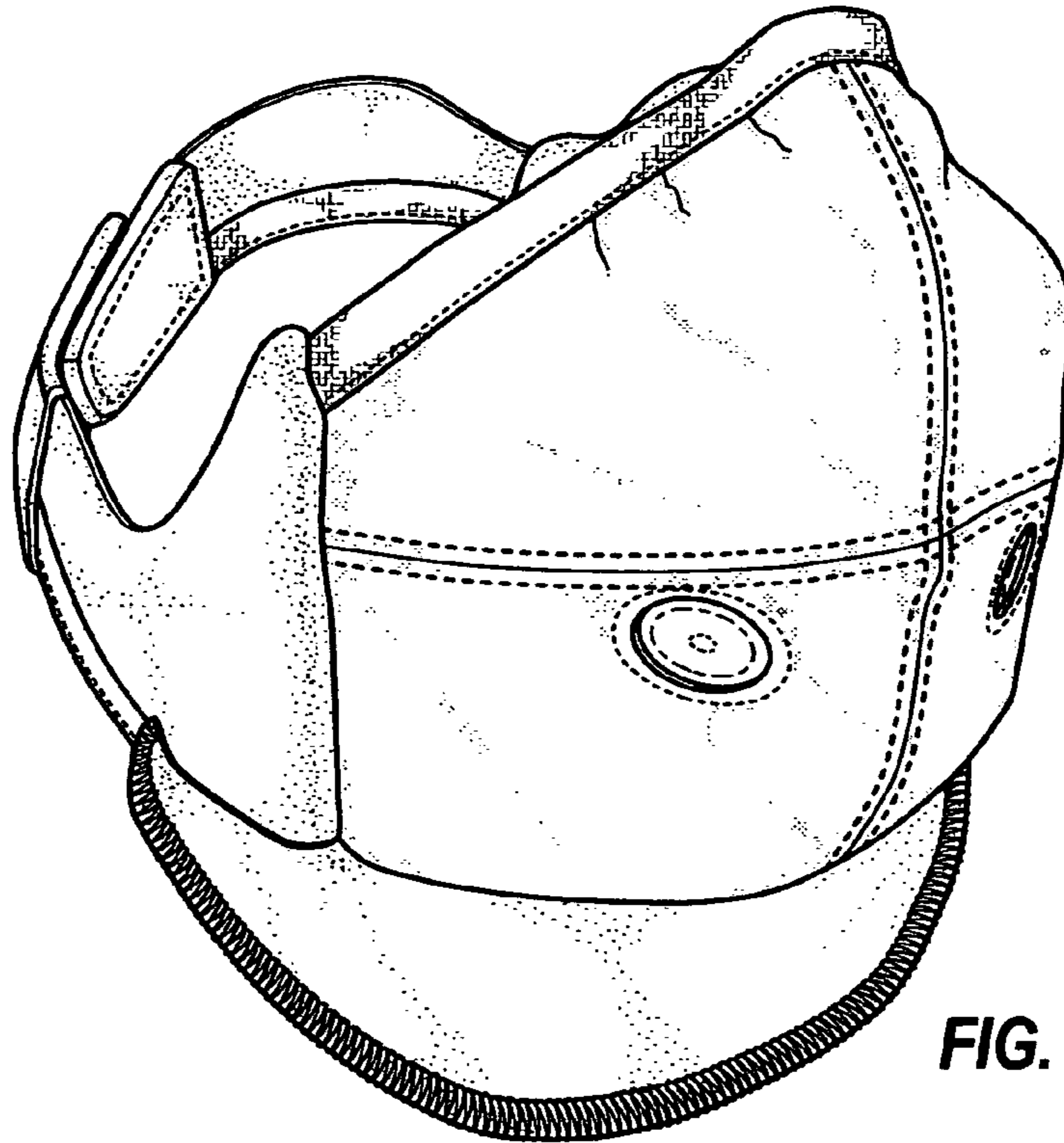

FIG. 2

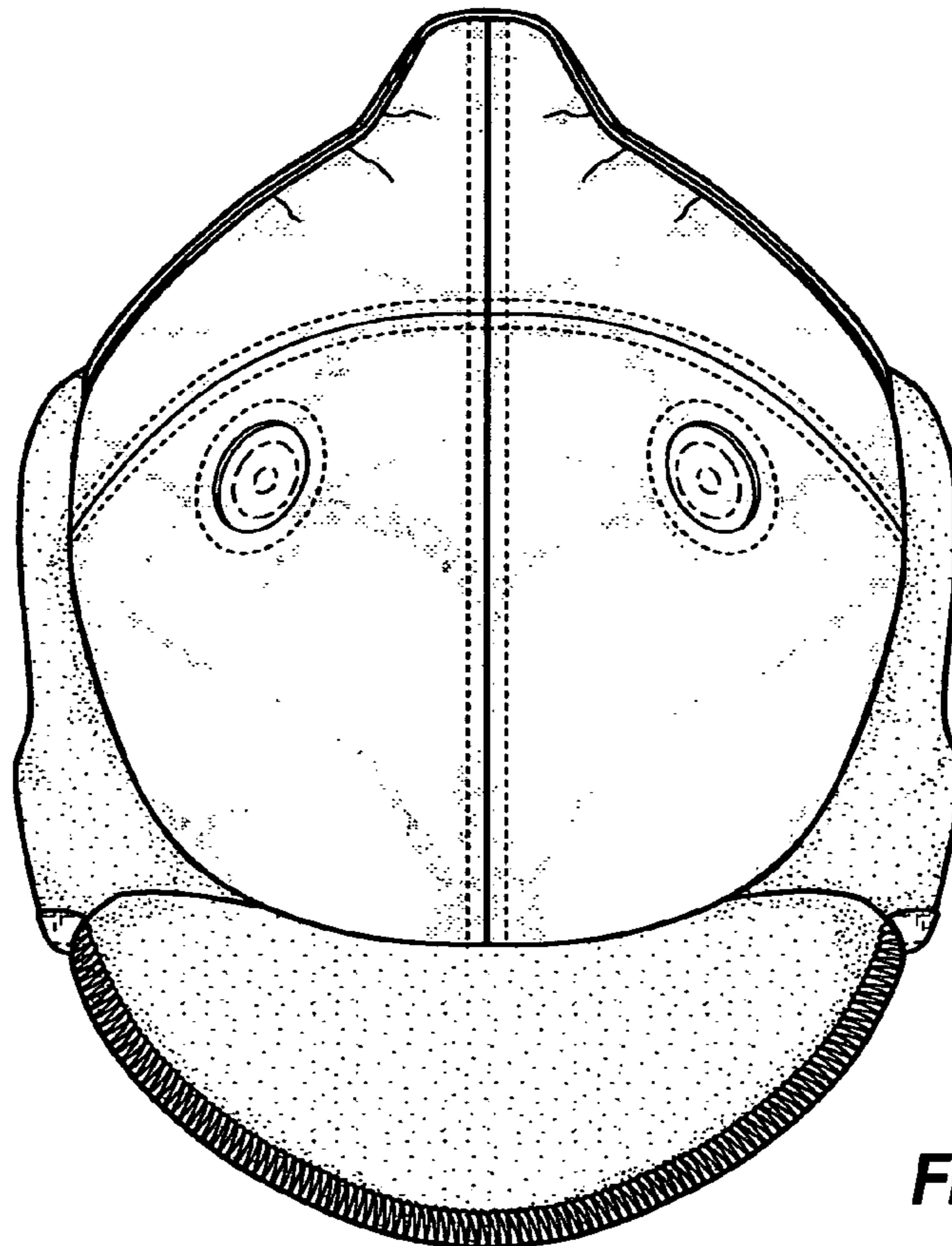

FIG. 3

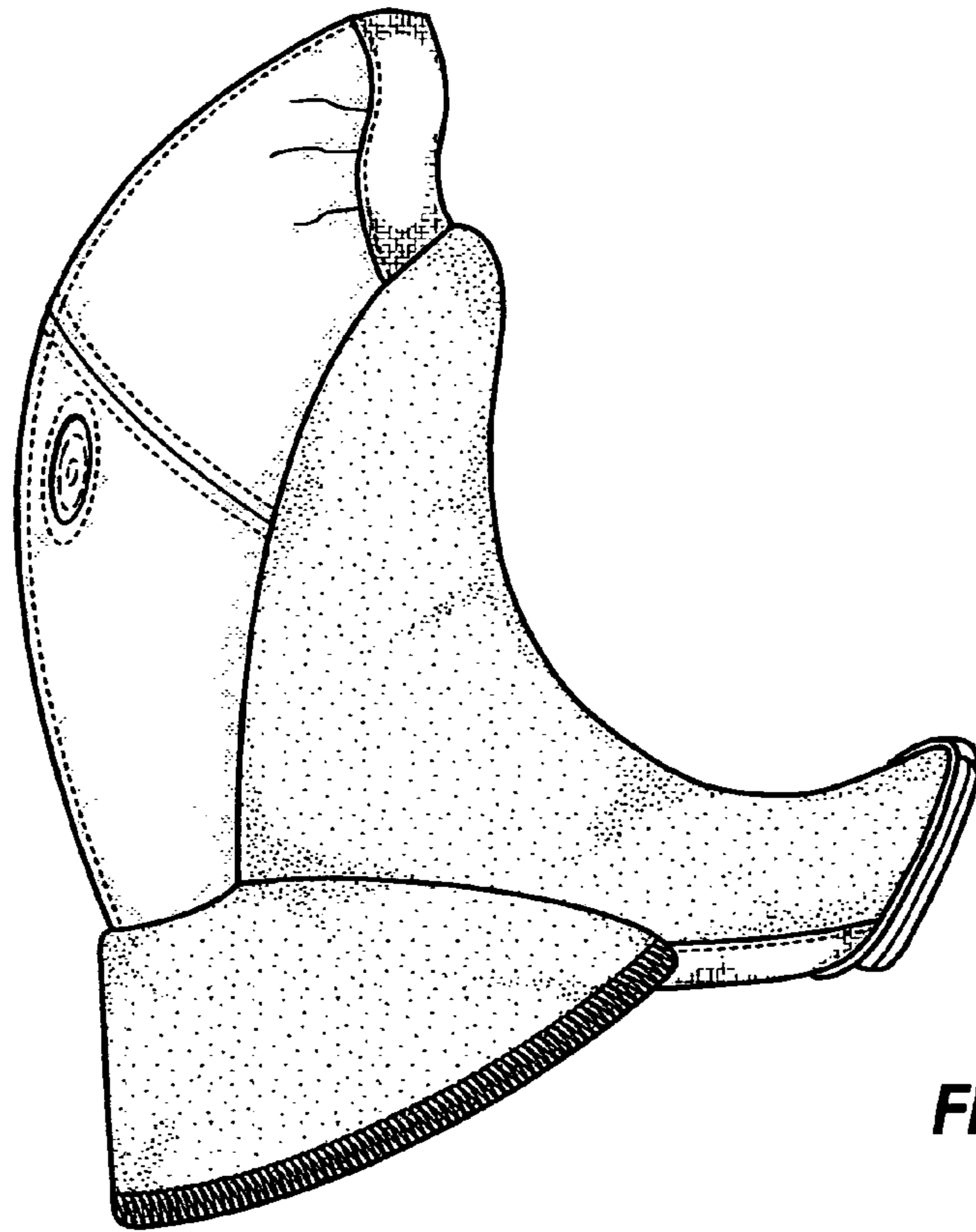

FIG. 4

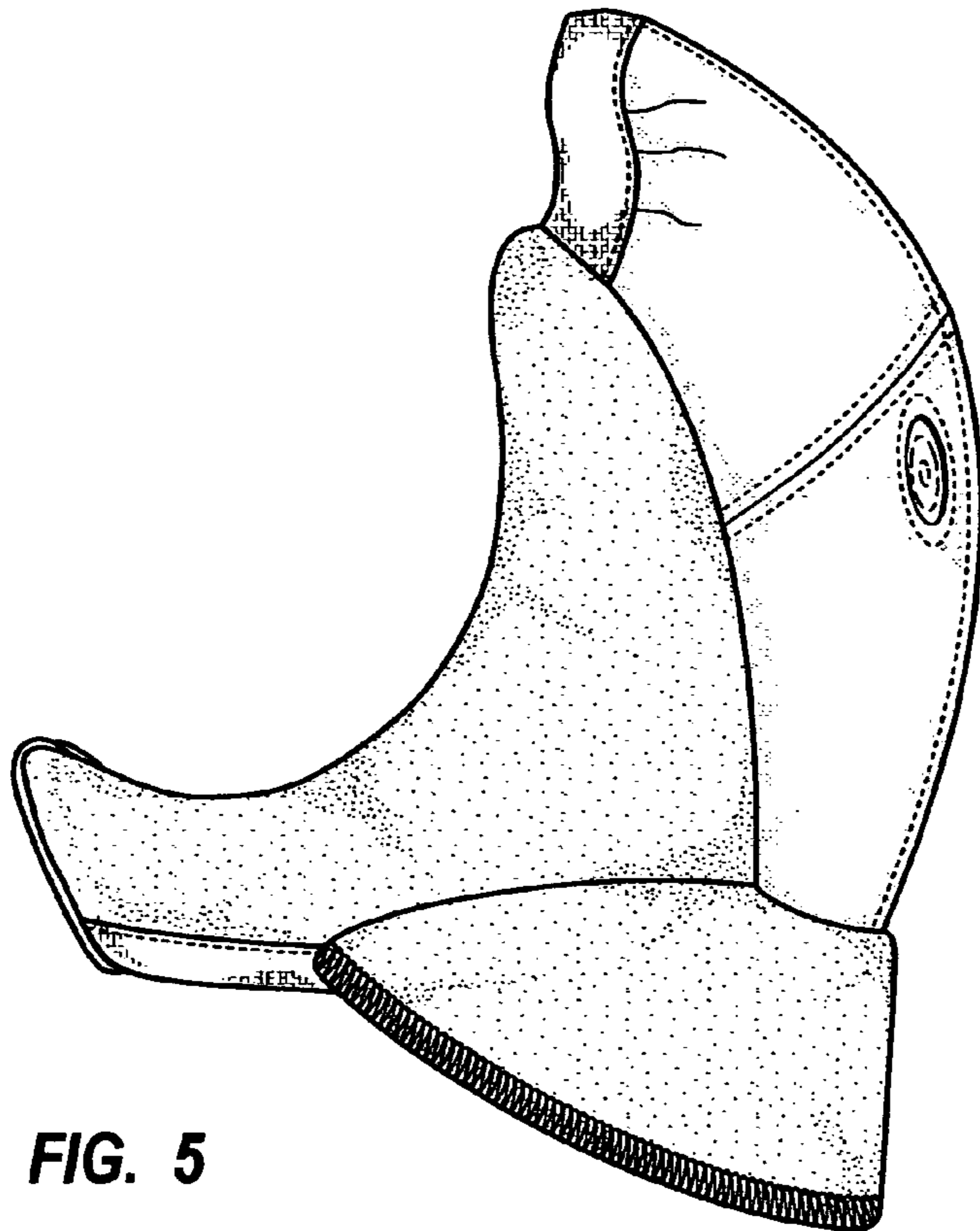

FIG. 5

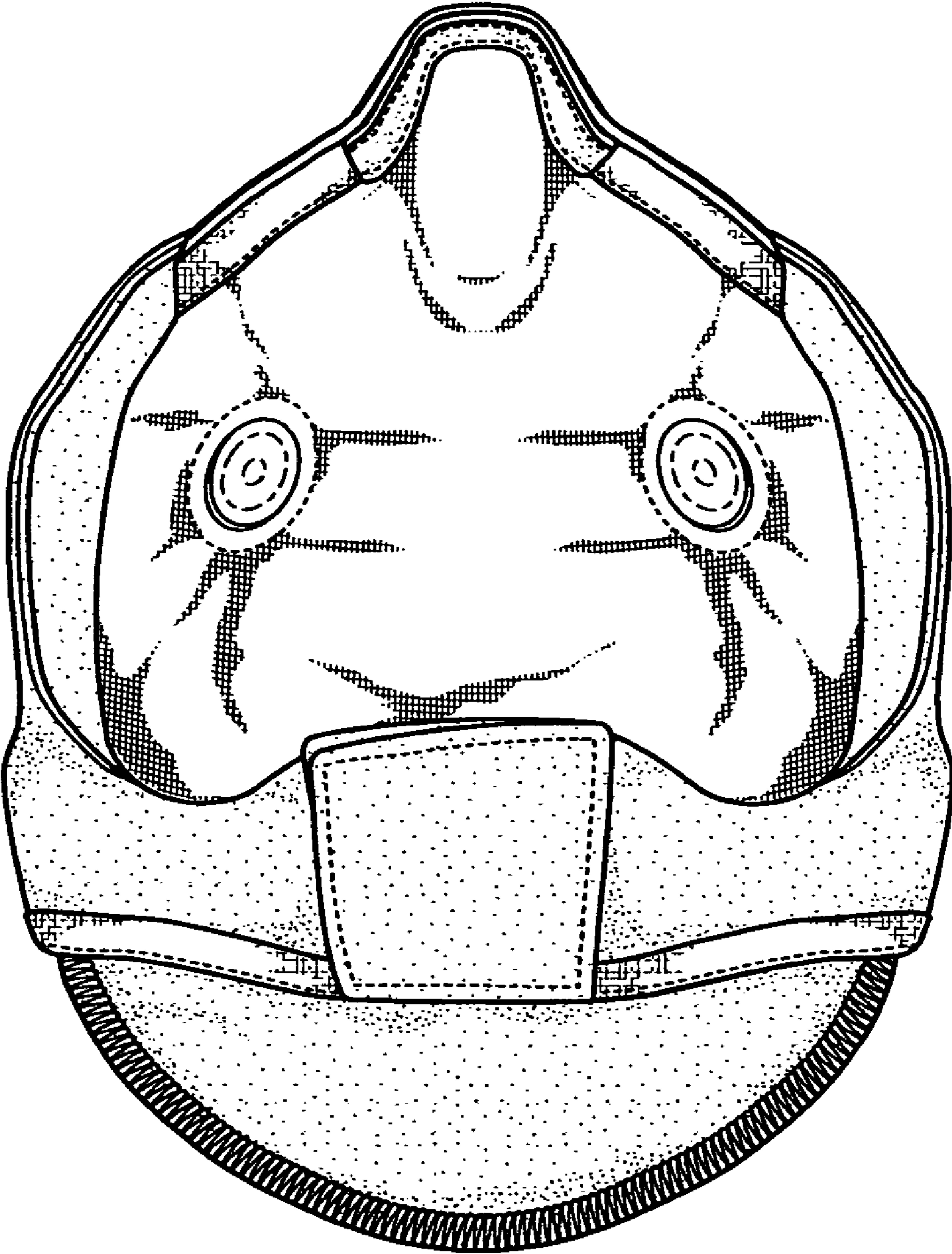

FIG. 6

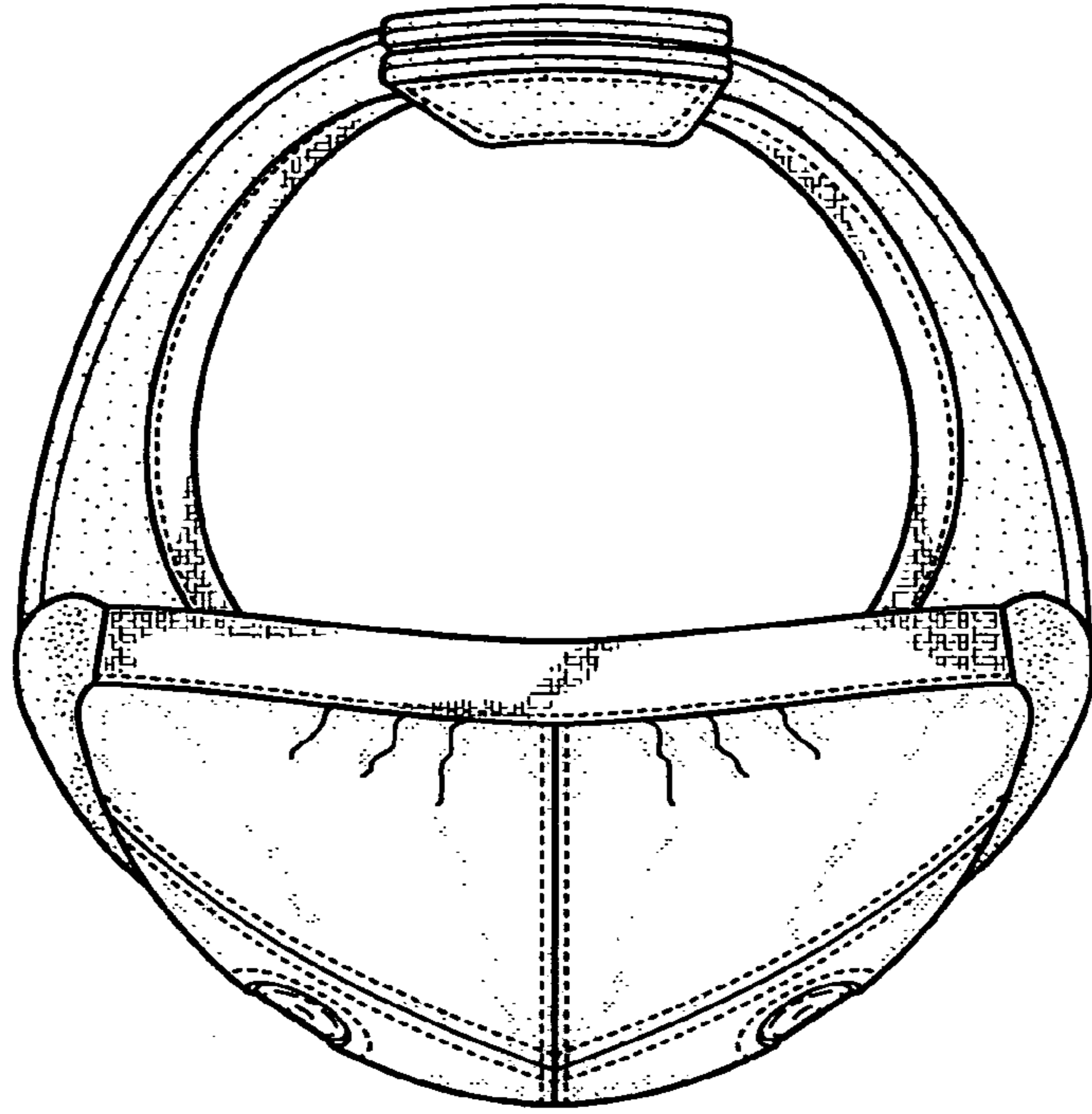

FIG. 7

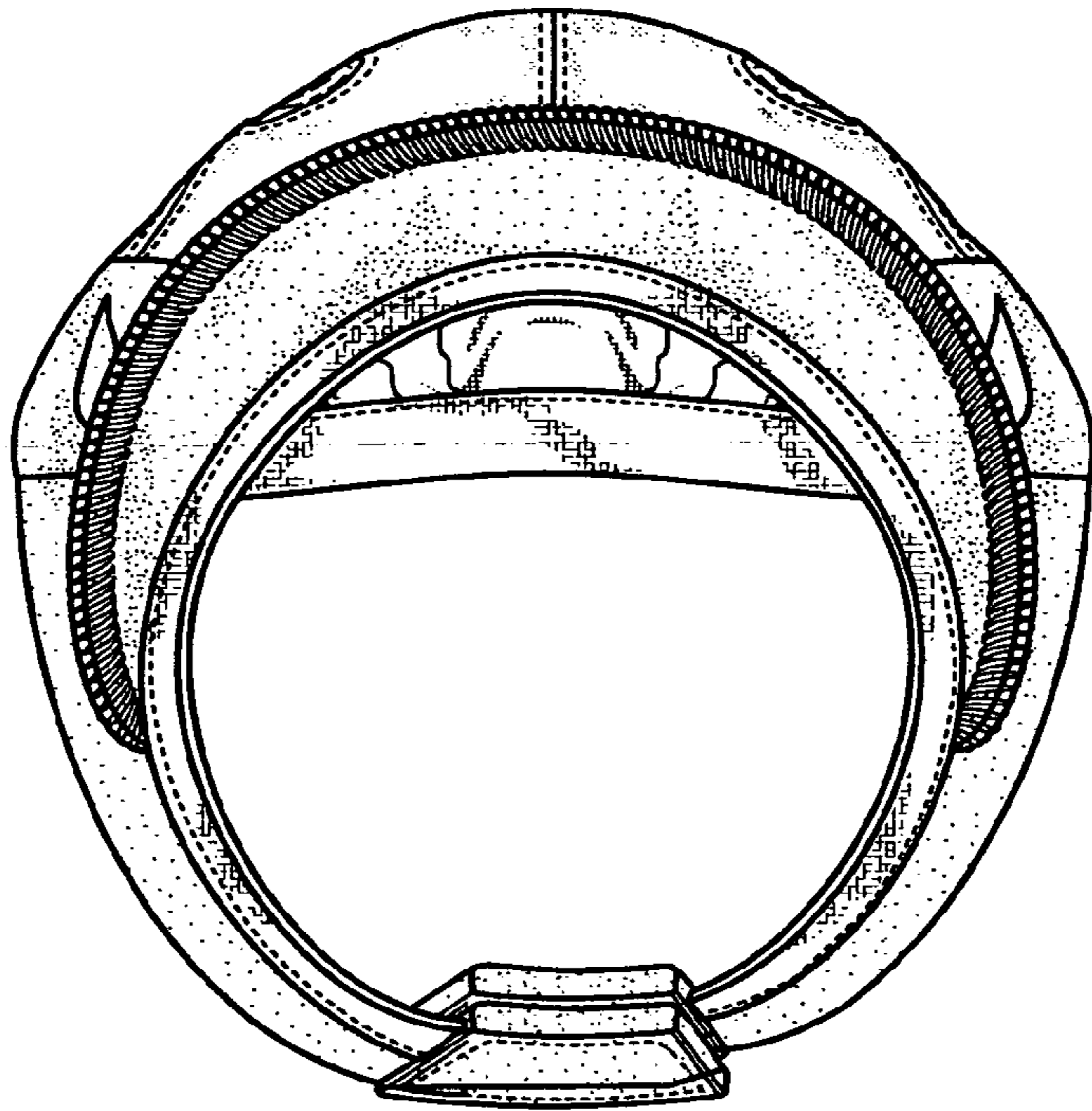

FIG. 8